



## Power Macintosh 9500 Series

---

Power Macintosh 9500/120, 9500/132, 9500/150,  
9500/180MP, and 9500/200





## Basics

---

### Power Macintosh 9500 Series





## Overview

The Power Macintosh 9500 Series computers are based on the PowerPC 604 microprocessor and support the industry-standard PCI (Peripheral Component Interconnect) bus specification. These computers are the most flexible, expandable, and highest-performance systems from Apple to date.

The microprocessor for the Power Macintosh 9500 Series computers is on separate plug-in card, which allows for easy upgrades. The Power Macintosh 9500 family includes five versions: the 9500/120, the 9500/132, the 9500/150, the 9500/180MP (multi-processor), and the 9500/200.





Features of the Power Macintosh 9500 Series include

- 120, 132, 150, 180 (multi-processor) or 200 MHz PowerPC 604 microprocessor card with built-in FPU
- Six PCI expansion slots
- 10 MB per second internal SCSI channel, 5 MB per second external SCSI channel
- 512K Level 2 cache
- DRAM expansion up to 1536 MB using 168-pin, 70 ns, 64-bit DIMMs
- A PCI Apple Accelerated Graphics card included with some configurations (the Power Macintosh 9500 Series does not include on-board video support)
- Built-in AAUI and 10BASE-T Ethernet
- AppleCD™ 600i 4x or 1200i 8x CD-ROM drive
- CD-quality stereo sound in/out
- Mac™ OS system software 7.5.2, 7.5.3, or 7.5.3 Revision 2





## Configurations

The Power Macintosh 9500/120 comes standard with

- 120 MHz PowerPC 604 processor card
- 16 MB DRAM minimum
- 1 GB hard drive
- AppleCD 600i CD-ROM drive
- Apple Accelerated Graphics card with 2 MB of VRAM

The Power Macintosh 9500/132 comes standard with

- 132 MHz PowerPC 604 processor card
- 16 MB DRAM minimum
- 2 GB hard drive
- AppleCD 600i CD-ROM drive





The Power Macintosh 9500/150 comes standard with

- 150 MHz PowerPC 604 processor card
- 16 or 32 MB DRAM minimum
- 2 GB hard drive
- AppleCD 600i CD-ROM drive

The Power Macintosh 9500/180MP comes standard with

- 180 MHz PowerPC 604e multi-processor card
- 16 or 32 MB DRAM minimum
- 2 GB hard drive
- AppleCD 1200i 8x-speed CD-ROM drive

The Power Macintosh 9500/200 comes standard with

- 200 MHz PowerPC 604e processor card
- 16 or 32 MB DRAM minimum
- 2 GB hard drive
- AppleCD 1200i 8x-speed CD-ROM drive





## PowerPC 604 Microprocessor

The Power Macintosh 9500 Series computers feature the highest performance PowerPC processor available: the PowerPC 604 RISC microprocessor. Designed to bring unprecedented levels of performance to desktop computers, the Power PC 604 processor offers up to 1.5 times the performance of the PowerPC 601 processor at the same clock speed. Features include

- Full RISC processing architecture
- Parallel processing units: one load-store unit, two integer units, one complex integer unit, and one floating point unit
- Separate built-in caches for data and instructions, 16 KB each, four-way set associative
- Advanced branching techniques for improved throughput





The PowerPC 604 processor is installed via a processor card that plugs into the Macintosh 9500 Series logic board, allowing for maximum flexibility with future upgrades.

## Multi-Processor Support

The Power Macintosh 9500/180MP features two 180 MHz PowerPC 604e chips on its microprocessor card. This computer provides extremely rapid performance for applications that can take advantage of its coprocessing capabilities.







## Peripheral Component Interconnect (PCI)

The Power Macintosh 9500 Series computers offer a Peripheral Component Interconnect (PCI) expansion bus. Because the PCI bus is an industry standard, most existing PCI 2.0-compliant cards (with the addition of a Mac OS-specific software driver) will work in the Power Macintosh 9500 Series computers.

PCI offers significantly higher performance than the NuBus architecture used in previous Macintosh models. Running at 33 MHz, the PCI bus is up to three times faster than NuBus, offering overall enhanced system performance, particularly in the areas of video and networking.





## Dual In-Line Memory Modules (DIMMs)

The Power Macintosh 9500 Series computers use DRAM Dual In-Line Memory Modules (DIMMs) instead of DRAM SIMMs.

Whereas SIMMs have 72 pins, DIMMs have 168 pins. The extra pins provide a 64-bit data path, compared to a 32-bit data path for SIMMs. In addition, DIMMs do not have to be installed in pairs like the SIMMs on earlier Macintosh models. (However, to take advantage of memory interleaving, the DIMMs should be installed in paired slots. See "Memory Configurations" in Basics for more information.)

**Important:** The Single In-Line Memory Modules (SIMMs) used in previous Macintosh models are NOT compatible with





the Power Macintosh 9500 Series computers.

**Note:** There is a double click seating process for installing DRAM DIMMs. Be sure to push the DIMMs all the way into the DIMM slots.





## Memory Configurations

The Power Macintosh 9500 Series logic board has 12 DRAM DIMM slots, each with a 64-bit data bus. You can increase the computer's DRAM to a total of 1536 MB using 5-volt, 64-bit-wide, 168-pin fast-paged mode, 70 ns DIMMs.

When installing DRAM DIMMs in the Power Macintosh 9500, fill slot A6 first, followed by B6, then A5, followed by B5, and so on. DRAM DIMMs can be installed individually; however, to take advantage of memory interleaving, which provides maximum performance, you must install the DIMMs in matching pairs and in paired slots (A6 and B6 first, then A5 and B5, and so on). DIMMs purchased from different manufacturers can be paired as long as they are the same size and speed.

**Note:** Memory interleaving allows the computer to read or





write to its memory while other memory reads or writes are occurring, thus providing for faster performance.

The graphic on the following page illustrates the memory locations on the Power Macintosh 9500 logic board.



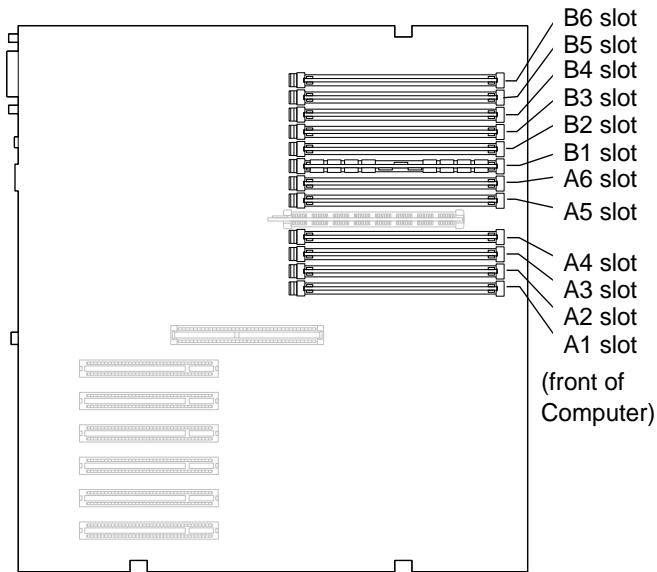

Figure: Power Macintosh 9500 Memory Locations





## Ethernet Support

There are two Ethernet ports on the Power Macintosh 9500 Series logic board: an AAUI port and a 10BASE-T port. You can use only one Ethernet port at one time, however. If you have cables plugged into both Ethernet ports, the computer uses the 10BASE-T port by default.

## PC Compatibility Cards

Apple computer offers two PC Compatibility Card upgrade kits that bring full DOS functionality to the Macintosh computer. Two versions of the PC Compatibility card are available: a 7" card and a 12" card. The cards plug into any available PCI slot on the logic board. Refer to the Upgrades chapter in this manual for installation instructions.





## GeoPort

Geoport is a hardware and software communications architecture that has been optimized for computer-telephony integration. It has three main attributes:

- It lets any computer connect to any telephone (analog or digital, public or private) anywhere in the world.
- Once connected, it supports an arbitrary number of independent data streams up to a total bandwidth of 2 MB/second.
- Unlike traditional asynchronous data communications (such as AppleTalk), GeoPort also supports isochronous data streams (such as real-time voice and video) and provides the real-time Application Program Interfaces (APIs) necessary to hide the implementation details from both the recipient and the sender.







By attaching an Apple GeoPort Telecom Adapter to the Power Macintosh 9500, you can enjoy all the features of a 14.4 modem, including data, fax, send and receive, and voice capabilities. The GeoPort Telecom Adapter serves as a line interface to standard (analog) telephone lines. The adapter is capable of sending or receiving data at up to 14.4 kbps and faxes at up to 9600 bps using the GeoPort Telecom Adapter software.





## The Cuda Chip

The Cuda is a microcontroller chip. Its function is to

- Turn system power on and off
- Manage system resets from various commands
- Maintain parameter RAM (PRAM)
- Manage the Apple Desktop Bus (ADB)
- Manage the real-time clock

Many system problems can be resolved by resetting the Cuda chip (see Symptom Charts for examples). Press the red Cuda reset button on the logic board to reset the Cuda chip. (See "Logic Board Diagram" later in this chapter to locate the Cuda reset button.) If you continue to experience system problems, refer to "Resetting the Logic Board" in this Basics chapter.





## Resetting the Logic Board

Resetting the logic board can resolve many system problems (refer to "Symptom Charts" for examples). Whenever you have a unit that fails to power up, you should follow this procedure before replacing any modules.

- 1 Unplug the computer.
- 2 Remove the logic board. (Refer to the Take Apart chapter for instructions on how to remove the logic board.)
- 3 Using a small flat-blade screwdriver, pry open the latch at the end of the battery holder and lift off the battery holder cover.
- 4 Remove the battery from its holder.





- 5 Verify the power supply cable is disconnected from the logic board and then press the Power On button. (See "Logic Board Diagram" later in this chapter to locate the Power On button.)
- 6 Wait at least 10 minutes before replacing the battery. Make sure the battery is installed in the correct +/- direction.
- 7 Reassemble the computer and test the unit.

**Note:** This procedure resets the computer's PRAM. Be sure to check the computer's time/date and other system parameter settings afterwards.

**Note:** If this procedure resolves the problem, claim an adjustment on an SRO. If not, replace the defective component and DO NOT claim the adjustment procedure.





## Fast SCSI

The Power Macintosh 9500 Series computers offer Fast SCSI support on the internal SCSI connector, which provides for significantly enhanced data throughput. The internal SCSI bus on these computers supports transfer rates up to 10 MB/sec.





## Rear View Diagram

The Power Macintosh 9500 Series computers offer the following external ports: SCSI, AAUI Ethernet, 10BASE-T Ethernet, serial printer (GeoPort compatible), serial modem (GeoPort compatible), ADB, sound input, and sound output.

Some configurations of the Power Macintosh 9500 also includes a DB-15 video port on the Apple Accelerated Graphics card, which installs in one of the PCI slots on the logic board.

The drawing on the next page illustrates the rear panel on the Power Macintosh 9500 Series computers.



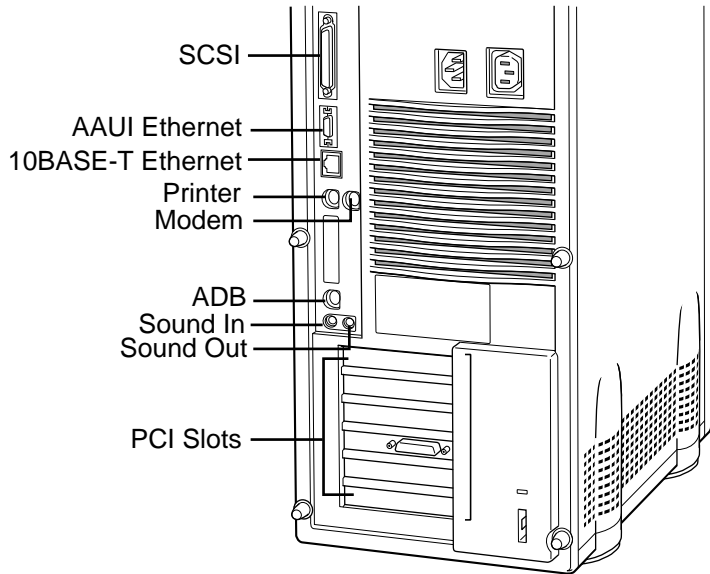

**Figure: Power Macintosh 9500 Rear Panel**





## Logic Board Diagram

The graphic on the following page illustrates the connectors on the Power Macintosh 9500 Series logic board.

**Note:** The board ships with 4 MB of ROM, which may either be soldered or installed as a ROM SIMM.





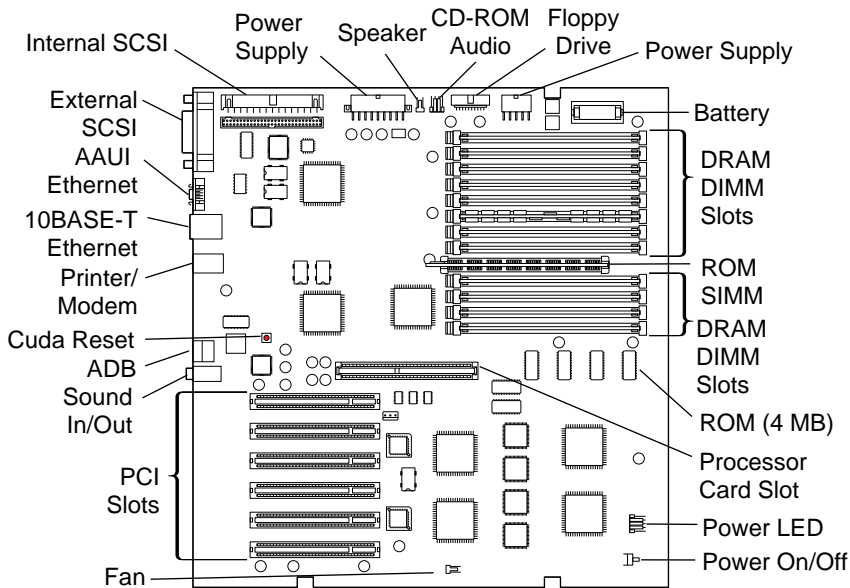

**Power Macintosh 9500 Logic Board**





## Specifications

Power Macintosh 9500 Series





## Processor

**9500/120**

PowerPC 604 RISC microprocessor running at 120 MHz  
Built-in FPU  
Requires system software version 7.5.2 or later with System  
Enabler version 701

**9500/132**

PowerPC 604 RISC microprocessor running at 132 MHz  
Built-in FPU  
Requires system software version 7.5.2 or later with System  
Enabler version 701

**9500/150**

PowerPC 604 RISC microprocessor running at 150 MHz  
Built-in FPU  
Requires system software version 7.5.3 or later with appropriate  
System Enabler





**9500/180MP**

Two PowerPC 604e RISC microprocessors each running at  
180 MHz

Built-in FPU

Requires system software 7.5.3 Revision 2 or later

**9500/200**

PowerPC 604e RISC microprocessor running at 200 MHz

Built-in FPU

Requires system software 7.5.3 Revision 2 or later





## Memory

<b>DRAM</b>	16 or 32 MB standard; expandable to 1536 MB Uses 168-pin, 64-bit, 70 ns or faster DRAM DIMMs
<b>ROM</b>	4 MB ROM (may be installed in ROM SIMM slot, or soldered on the logic board)
<b>Cache</b>	512K Level 2 cache soldered on the logic board
<b>Clock/Calendar</b>	CMOS custom circuitry with long-life battery





## I/O Interfaces

- SCSI** Dual-channel asynchronous SCSI interface; external channel supports up to seven SCSI devices; internal channel supports a hard disk array
- Serial** Two RS-232/RS-422 serial ports compatible with LocalTalk and GeoPort cables; mini DIN-8 connectors
- ADB** One Apple Desktop Bus port for a keyboard, mouse, etc.
- Ethernet** One AAUI and one 10BASE-T Ethernet port (if cables are plugged into both ports, system defaults to 10BASE-T)



**Expansion**

Six PCI expansion slots, compatible with all PCI 2.0 specification-compliant cards (not NuBus compatible)

**Sound**

16-bit stereo sound input and output ports

**Video**

**9500/120, 9500/150,  
9500/180MP, and  
9500/200:**

DB-15 video port for display on Apple Accelerated Graphics card

**9500/132:**

No built-in video support; requires separate video card





## I/O Devices

### **Keyboard**

Standard, extended, or adjustable keyboard; keyboard draws 25-80 mA, depending on model type

### **Mouse**

ADB Mouse II; mouse draws up to 10 mA

### **Microphone**

Apple PlainTalk microphone standard







## Video Support

**9500/120, 9500/150,  
9500/180MP, and  
9500/200**

Ships with Apple Accelerated Graphics card, which includes 2 MB of VRAM (expandable to 4 MB via third-party memory module expansion card); supports all Apple and most third-party displays, including monochrome, color, VGA, and SVGA; supports up to 16.7 million colors on Apple color displays up to 17" and with 2 MB VRAM upgrade supports 16.7 million colors on Apple displays up to 21"

**9500/132**

No built-in video support; requires third-party video card for display support





## Disk Storage

### Hard Drive

**9500/120:** One 1 GB internal hard drive

**9500/132, 9500/150,  
9500/180MP, and  
9500/200:** One 2 GB internal hard drive

### Floppy Drive

One Apple SuperDrive 1.4 MB floppy drive

### CD-ROM Drive

One internal AppleCD 600i 4x-speed or 1200i 8x-speed  
CD-ROM drive





## Electrical

**Line Voltage** 100—240 VAC, RMS single phase, automatically configured

**Frequency** 50—60 Hz, single phase

### Maximum Power

**DC Power** 225 W, not including monitor

**AC Power** 340 W maximum continuous; 520 W peak input





# Physical

## Dimensions

<b>Height</b>	16.9 in. (430 mm)
<b>Width</b>	7.75 in. (196 mm)
<b>Depth</b>	15.75 in. (400 mm)
<b>Weight</b>	28 lb. (12.7 kg); weight varies depending on devices installed





## Environmental

**Operating  
Temperature**

50 to 104° F (10 to 40° C)

**Storage  
Temperature**

—40 to 116° F (—40 to 47° C)

**Relative Humidity**

5% to 95% noncondensing

**Maximum Altitude**

10,000 ft. (3,048 m)





# Troubleshooting

---

## Power Macintosh 9500 Series





## General

The Symptom Charts included in this chapter will help you diagnose specific symptoms related to your product. Because cures are listed on the charts in the order of most likely solution, try the first cure first. Verify whether or not the product continues to exhibit the symptom. If the symptom persists, try the next cure. (Note: If you have replaced a module, reinstall the original module before you proceed to the next cure.)

If you are not sure what the problem is, or if the Symptom Charts do not resolve the problem, refer to the Flowchart for the product family.

For additional assistance, contact Apple Technical Support.





## Cleaning Procedure for Card Connectors

It is possible for residue to build up on the gold edge connector pins on some PCI cards, which could cause a variety of symptoms.

If you are having problems with a PCI card, inspect the connector pins with a magnifying glass. If you find residue, use a pencil eraser to gently clean the pins.







# Symptom Charts

## Power Supply

System doesn't power up

- 1 Reseat processor card, video card, and ROM SIMM (if present).
- 2 Reset Cuda chip. (Refer to The Cuda Chip in Basics for instructions.)
- 3 Reset logic board. (Refer to Resetting the Logic Board in Basics for instructions.)
- 4 Replace power supply.
- 5 Replace processor card.
- 6 Replace logic board. Note: When you replace the logic board, be sure the LED cable is not interfering with the power actuator.





## Error Chords

One-part error chord sounds during startup sequence

- 1 Disconnect SCSI data cable from hard drive and reboot system. If startup sequence is normal, initialize hard drive using Drive Setup and then run Drive Setup Updater utility program. Test unit again with SCSI data cable connected. If error chord still sounds, replace hard drive.
- 2 Disconnect floppy drive cable from floppy drive and reboot system. If startup sequence is normal, replace floppy drive.
- 3 Reseat processor card.
- 4 Replace processor card.
- 5 Replace logic board. Retain customer's DIMMs. Note: When you replace the logic board, be sure the LED cable is not interfering with the power actuator.





Eight-part error chord (death chimes) sounds during startup sequence

- 1 Make sure DRAM is installed first in banks A6 and B6, followed by banks A5 and B5, etc. Do not install DRAM in banks A1 and B1 until all other banks are full.
- 2 Replace DRAM DIMMs one at a time to test DRAM. Replace any faulty DIMMs.
- 3 Replace logic board. Note: When you replace the logic board, be sure the LED cable is not interfering with the power actuator.





## System

Does not power on, screen is black, fan is not running and LED is not lit

- 1 Check power cables.
- 2 Plug monitor directly into wall socket, and verify that monitor has power.
- 3 Reseat ROM SIMM (if present) and processor card. The logic board must have a processor card installed to operate.
- 4 Reset Cuda chip. (Refer to The Cuda Chip in Basics for instructions.)
- 5 Reset logic board. (Refer to Resetting the Logic Board in Basics for instructions.)
- 6 Replace power cord.
- 7 Replace power supply.
- 8 Replace processor card.
- 9 Replace logic board. Retain customer's DIMMs. Note: When you replace the logic board, be sure the LED cable is not interfering with the power actuator.





Clicking, chirping,  
or thumping

- 1 Remove all PCI cards and test the unit. If problem does not occur with cards removed, begin replacing them one at a time to determine which card is causing the problem. Replace problem card with known-good card.
- 2 Remove hard drive. If problem no longer occurs, replace hard drive with a known-good drive.
- 3 Replace power supply.
- 4 Replace processor card.
- 5 Replace logic board. Retain customer's DIMMs. Note: When you replace the logic board, be sure the LED cable is not interfering with the power actuator.
- 6 Replace floppy drive cable.
- 7 Replace floppy drive.





System shuts down  
intermittently

- 1 Make sure air vents are clear. Thermal protection circuitry may shut down system. After 30 to 40 minutes, system should be OK.
- 2 Make sure power cord is firmly plugged in.
- 3 Verify fan is plugged in and working. Replace if necessary.
- 4 Replace power cord.
- 5 Check battery.
- 6 Reset Cuda chip. (Refer to The Cuda Chip in Basics for instructions.)
- 7 Reset logic board. (Refer to Resetting the Logic Board in Basics for instructions.)
- 8 Replace power supply.
- 9 Replace processor card.
- 10 Replace logic board. Retain customer's DIMMs. Note: When you replace the logic board, be sure the LED cable is not interfering with the power actuator.





System  
intermittently  
crashes or hangs

- 1 Verify system software is version 7.5.2 or later (Power Macintosh 9500/120 and 9500/132) or 7.5.3 or later (Power Macintosh 9500/150).
- 2 Verify DIMMs are noncomposite.
- 3 Verify software is known-good. Do a clean install of the system software.
- 4 Verify software is Power Macintosh 9500 compatible (contact developer). Also, try booting with extensions off to determine if there are system init problems.
- 5 Clear parameter RAM. Hold down <Command> <Option> <P> <R> during startup but before "Welcome to Macintosh" appears.
- 6 Remove all DRAM DIMMs and try replacing them one at a time to test. Replace any bad DIMMs.
- 7 Replace processor card.
- 8 Replace logic board. Retain DIMMs. Note: When you replace the logic board, be sure the LED cable is not interfering with the power actuator.





During startup, following message is displayed, "This startup disk will not work on this Macintosh model...."

- 1 Verify that startup disk is good.
- 2 Verify system software is version 7.5.2 or later (Power Macintosh 9500/120 and 9500/132) or 7.5.3 or later (Power Macintosh 9500/150).
- 3 Do a clean install of the system software.







## Video

Screen is black, boot tone is present, drive operates, fan is running, and LED is lit

- 1 Adjust brightness on monitor.
- 2 Clear parameter RAM. Hold down <Command> <Option> <P> <R> during startup but before "Welcome to Macintosh".
- 3 Verify video card is installed and reseal card.
- 4 Reset Cuda chip. (Refer to The Cuda Chip in Basics.)
- 5 Reset logic board. (See Resetting the Logic Board in Basics.)
- 6 Replace video cable.
- 7 Remove all DRAM DIMMs and try replacing them one at a time to test. Replace any bad DIMMs.
- 8 Replace video card.
- 9 Test with known-good monitor. Replace monitor if necessary. Refer to appropriate monitor manual to troubleshoot defective monitor.
- 10 Replace processor card.
- 11 Replace logic board. Retain customer's DIMMs.





Screen is black, no boot tone and drive does not operate, but fan is running and LED is lit

- 1 Reset Cuda chip. (Refer to The Cuda Chip in Basics for instructions.)
- 2 Reset logic board. (Refer to Resetting the Logic Board in Basics for instructions.)
- 3 Remove all DRAM DIMMs and try replacing them one at a time to test. Replace any bad DIMMs.
- 4 Replace processor card.
- 5 Replace logic board. Retain customer's DIMMs. Note: When you replace the logic board, be sure the LED cable is not interfering with the power actuator.
- 6 Replace power supply.





Boot tone is present and screen lights up, but nothing is displayed on screen

- 1 Reset Cuda chip. (Refer to The Cuda Chip in Basics for instructions.)
- 2 Reset logic board. (Refer to Resetting the Logic Board in Basics for instructions.)
- 3 Replace video cable.
- 4 Replace video card.
- 5 Test with known-good monitor. Replace monitor if necessary. Refer to appropriate monitor manual to troubleshoot defective monitor.
- 6 Replace processor card.
- 7 Replace logic board. Retain customer's DIMMs. Note: When you replace the logic board, be sure the LED cable is not interfering with the power actuator.





## Floppy Drive

Internal floppy drive does not operate

- 1 Replace floppy disk with known-good disk.
- 2 Replace floppy drive cable.
- 3 Replace floppy drive.
- 4 Replace processor card.
- 5 Replace logic board. Retain customer's DIMMs. Note: When you replace the logic board, be sure the LED cable is not interfering with the power actuator.

During system startup, disk ejects; display shows icon with blinking "X"

- 1 Replace disk with known-good system disk.
- 2 Replace floppy drive cable.
- 3 Replace floppy drive.
- 4 Replace processor card.
- 5 Replace logic board. Retain customer's DIMMs. Note: When you replace the logic board, be sure the LED cable is not interfering with the power actuator.





Does not eject disk

- 1 Switch off computer. Hold mouse button down while you switch computer on.
- 2 Replace floppy drive cable.
- 3 Replace floppy drive.
- 4 Replace processor card.
- 5 Replace logic board. Retain customer's DIMMs. Note: When you replace the logic board, be sure the LED cable is not interfering with the power actuator.

Attempts to eject disk, but doesn't

- 1 Reseat floppy drive bezel and drive so bezel slot aligns correctly with drive.
- 2 Replace floppy drive.





Internal floppy drive runs continuously

- 1 Replace disk with known-good floppy disk.
- 2 Replace floppy drive cable.
- 3 Replace floppy drive.
- 4 Replace processor card.
- 5 Replace logic board. Retain customer's DIMMs. Note: When you replace the logic board, be sure the LED cable is not interfering with the power actuator.

MS-DOS drive does not recognize a disk formatted on a 1.4 MB drive

To read and write files with either MS-DOS or 1.4 MB drive, format all disks with MS-DOS drive first.





## Hard Drive

Single internal hard drive does not operate; drive doesn't spin

- 1 Replace hard drive power cable.
- 2 Replace hard drive. If problem resolved, reinstall SCSI device driver and system software.
- 3 Replace power supply.

No internal SCSI drives operate

- 1 Verify there are no duplicate SCSI device addresses.
- 2 Disconnect external SCSI devices and check for proper termination. Only last device in SCSI chain should be terminated.
- 3 Replace SCSI data cable.
- 4 Replace power supply.
- 5 Replace processor card.
- 6 Replace logic board. Retain customer's DIMMs. Note: When you replace the logic board, be sure the LED cable is not interfering with the power actuator.





Drive does not appear on the desktop

- 1 Verify there are no duplicate SCSI device addresses.
- 2 Update the SCSI device driver using Drive Setup and then run Drive Setup Updater utility program. Run Disk First Aid to verify the condition of the drive's directory structure.
- 3 Replace the SCSI hard drive cable.
- 4 If drive is not initialized, use Drive Setup to initialize it and then run Drive Setup Updater utility program.
- 5 Replace with known-good hard drive.
- 6 If the hard drive still doesn't work, switch back to the original hard drive and replace the logic board.

Works with internal or external SCSI devices but not with both

- 1 Verify there are no duplicate SCSI device addresses.
- 2 Replace terminator on external SCSI device.
- 3 Verify that SCSI device at end of internal SCSI data cable is only device terminated.
- 4 Refer to appropriate manual to troubleshoot defective external device.







## Peripherals

Cursor does not move

- 1 Check mouse connection.
- 2 Inspect inside of mouse for buildup of dirt or other contaminants. Clean mouse if necessary.
- 3 If mouse was connected to keyboard, connect mouse to computer ADB port instead. If mouse works, replace keyboard.
- 4 Replace ADB cable.
- 5 If mouse does not work in any ADB port on computer, replace mouse.
- 6 Replace processor card.
- 7 Replace logic board. Retain customer's DIMMs. Note: When you replace the logic board, be sure the LED cable is not interfering with the power actuator.





Cursor moves, but clicking mouse button has no effect

- 1 Boot from floppy or bootable CD.
- 2 Replace mouse.
- 3 Replace logic board. Retain customer's DIMMs. Note: When you replace the logic board, be sure the LED cable is not interfering with the power actuator.

Double-click doesn't open application, disk, or server

- 1 Remove duplicate system folders.
- 2 Clear parameter RAM. Hold down <Command> <Option> <P> <R> during startup but before "Welcome to Macintosh" appears.
- 3 If mouse was connected to keyboard, connect mouse to computer ADB port instead. If mouse works, replace keyboard.
- 4 If mouse does not work in any ADB port on computer, replace mouse.
- 5 Replace logic board. Retain customer's DIMMs. Note: When you replace the logic board, be sure the LED cable is not interfering with the power actuator.





No response to any key on keyboard

- 1 Check keyboard connection to ADB port.
- 2 Replace keyboard cable.
- 3 Replace keyboard.
- 4 Replace logic board. Retain customer's DIMMs. Note: When you replace the logic board, be sure the LED cable is not interfering with the power actuator.

Known-good serial printer does not work

- 1 Verify you have correct version of system software.
- 2 Verify that Chooser is set correctly.
- 3 Reinstall correct printer drivers.
- 4 Do clean install of system software.
- 5 Replace printer interface cable.
- 6 Replace logic board. Retain customer's DIMMs. Note: When you replace the logic board, be sure the LED cable is not interfering with the power actuator.





Known-good network  
printer does not print

- 1 Check network connections.
- 2 Verify you have correct version of system software.
- 3 Verify that Chooser is set correctly.
- 4 Does printer show up in Chooser? If so, do clean install of system software and/or network and printer software.
- 5 Replace logic board. Retain customer's DIMMs. Note: When you replace the logic board, be sure the LED cable is not interfering with the power actuator.





## CD-ROM Drive

CD-ROM drive does not work

- 1 Try using known-good compact disc.
- 2 Replace CD-ROM drive mechanism.

Macintosh does not display CD-ROM icon once CD is inserted in drive

- 1 Verify that CD-ROM software is installed.
- 2 Replace CD-ROM drive mechanism.
- 3 Replace SCSI data cable.

Computer with 600i CD-ROM drive makes stuttering sounds when playing CD+ or CD-R formatted discs or CD-ROM disc won't mount

Replace CD-ROM drive.





## Miscellaneous

No sound from speaker

- 1 Verify that volume setting in Control Panel is 1 or above.
- 2 Clear parameter RAM. Hold down <Command> <Option> <P> <R> during startup but before "Welcome to Macintosh" appears.
- 3 Verify speaker is plugged into logic board.
- 4 Replace speaker.
- 5 Replace logic board. Retain customer's DIMMs.





Errors occur when initializing or erasing floppy disks and/or 1.4 MB disks show only 1 MB available after initialization

This problem only occurs on systems using a 180 MHz or faster processor card. Upgrade to system software version 7.5.4 to resolve this problem (the Apple recommended solution) or, alternatively, install the Power Mac Format Patch, which can be found on the original system disks that shipped with the computer.

To install the patch:

- While holding down the Option key, drag the Power Mac Format Patch icon onto the System Folder's icon.
- Click OK to automatically place the patch in the Extensions folder.
- Restart the computer by choosing Restart from the Special menu.





Take Apart

---

Power Macintosh 9500 Series







## Top Housing



No preliminary steps are required before you begin this procedure.

**Note:** The top housing covers the top, front, and left and right sides of the computer.

**IMPORTANT:** Never operate the computer with the top housing removed. Failure to comply may result in irreparable damage to internal components.



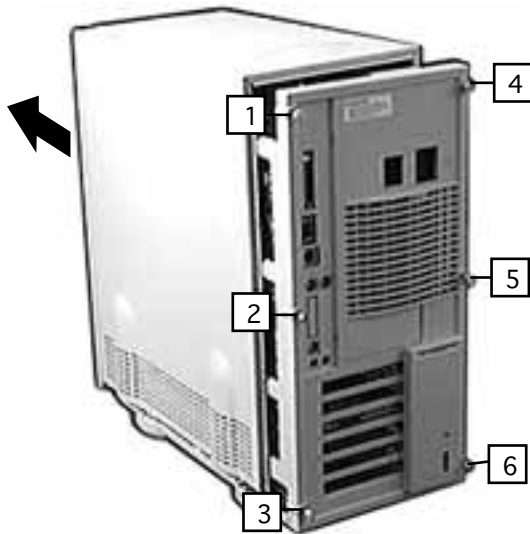

- 1 Loosen the six captive cover screws on the rear panel and slide the top housing forward about 1/2 an inch.





- 2 Lift straight up on the top housing to remove it from the computer.





## CD-ROM Drive

Before you begin, remove the top housing.

**Note:** The CD-ROM drive is located in the top drive bay.

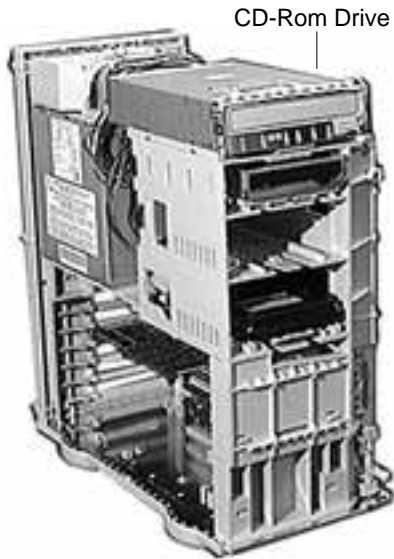

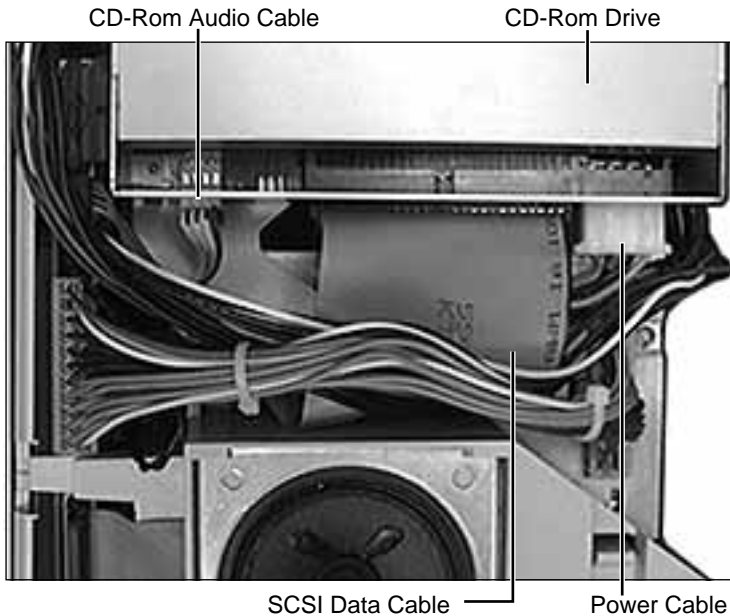

- 1 Disconnect the SCSI data cable, audio cable, and power cable from the back of the CD-ROM drive.



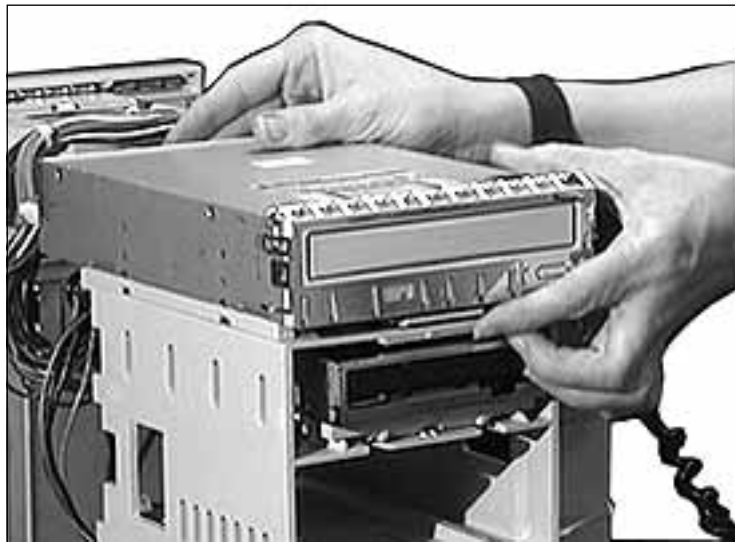

- 2 Pull up on the retaining clip at the back of the CD-ROM drive and slide the drive forward to remove it from the computer.

**Note:** Be sure to remove the CD-ROM drive from its carrier before returning the drive to Apple.





## Floppy Drive

Before you begin, remove the following:

- Top Housing
- CD-ROM Drive

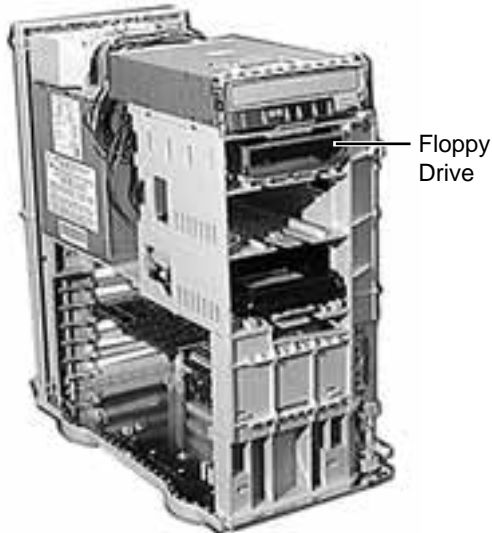

**Note:** The floppy drive is located in the second drive bay from the top.





- 1 Disconnect the floppy drive cable from the logic board and remove the cable from the plastic guides.

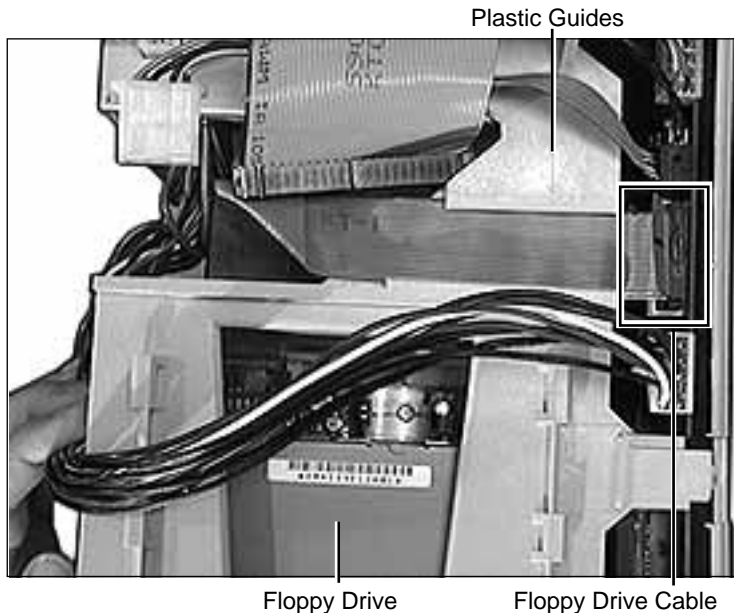



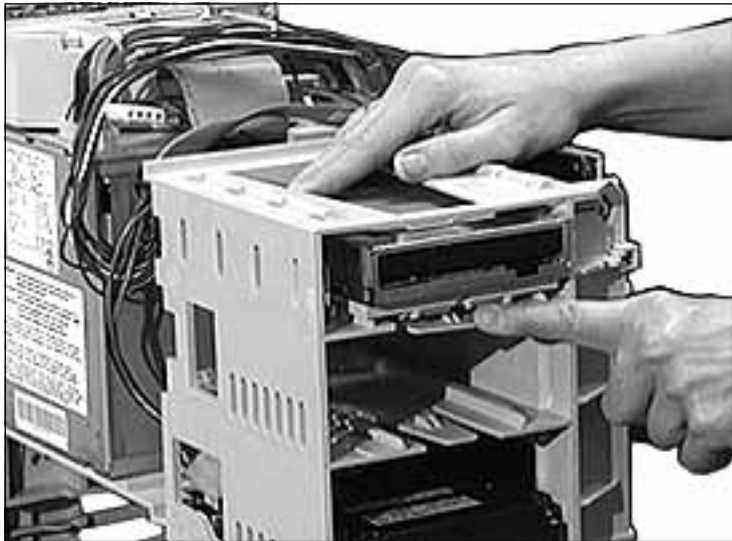

- 2 Press down the retaining clip at the back of the floppy drive and slide the floppy drive forward about two inches.
- 3 Disconnect the floppy drive cable from the back of the floppy drive and remove the floppy drive from the computer.

**Replacement Note:** Be sure to remove the floppy drive from its carrier before returning the drive to Apple.





## Hard Drive

Before you begin, remove the top housing.

**Note:** The hard drive is located in the bottom drive bay.

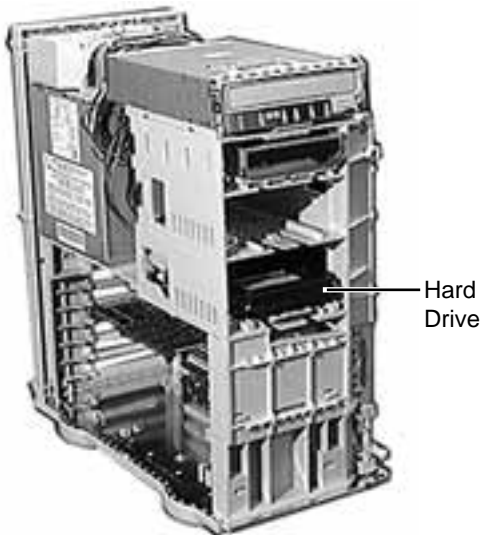



- 1 Disconnect the SCSI data cable and hard drive power cable from the hard drive.

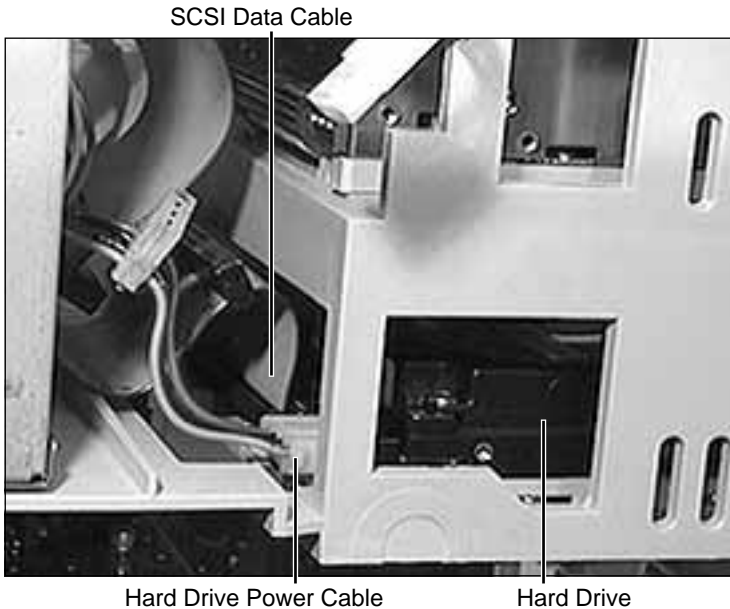



- 2 Press down the retaining clip at the back of the hard drive and slide the hard drive forward to remove it from the computer.

**Note:** For information on removing the hard drive from its carrier and returning drives, cables, and carriers to Apple, refer to Additional Procedures in the Hard Drives manual.





## Power Supply

Before you begin, remove the top housing.

**Note:** As you face the computer, the power supply is located in the back of the chassis, directly beneath the speaker.

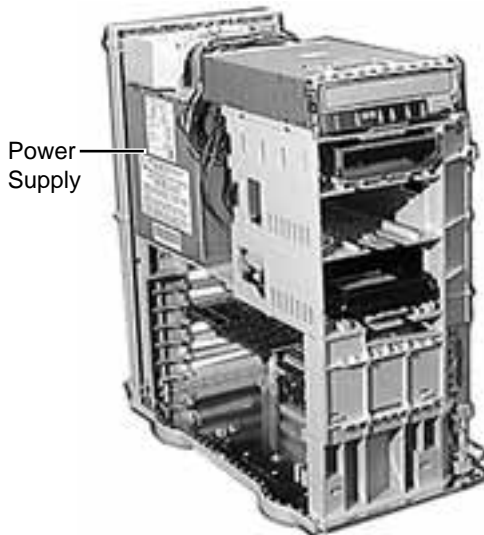

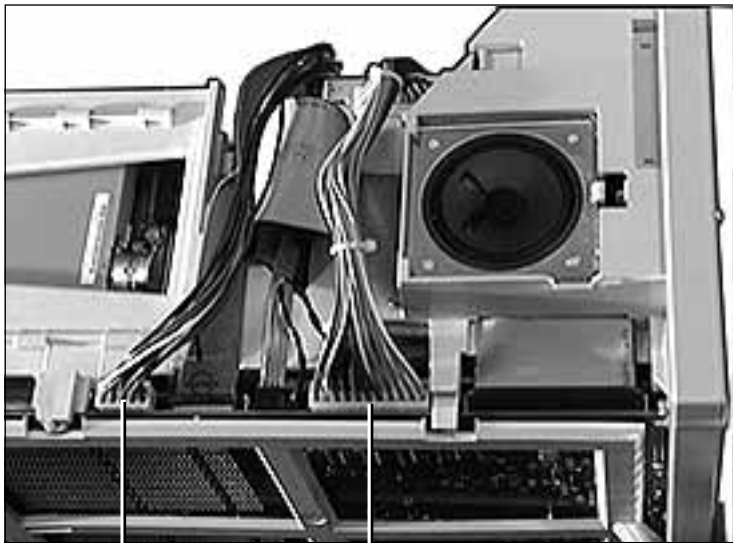

Power Supply Cable

Power Supply Cable

- 1 Disconnect the two cables that run from the power supply to the logic board.

**Note:** The 10-pin power supply cable (the cable on the left in the graphic) supplies 3.3 V power for the processor card. The 22-pin cable (the cable on the right in the graphic) supplies 5 V and +/- 12 V power for the logic board.





- 2 Turn the computer sideways so you are facing the power supply. (The power supply should be to your left and the drive bays to your right.)
- 3 Locate the chassis support brace, which is between the power supply and the drive bays.





Chassis Support Brace

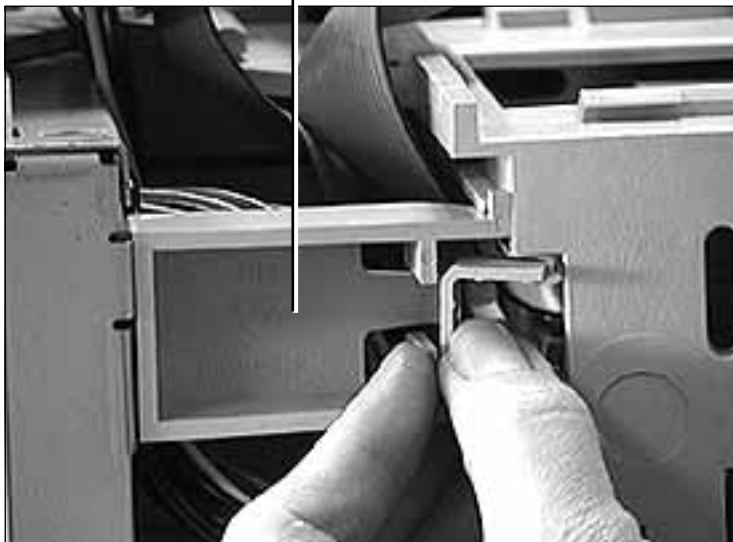

- 4 Push in on the latch located on the right side of the chassis support brace and pull out the brace to remove it.





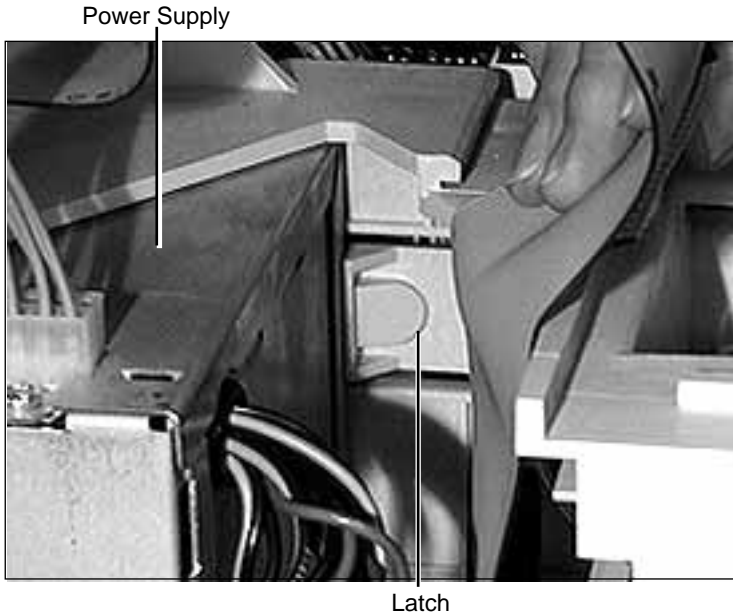

- 5 Push in on the plastic latch that secures the power supply to the chassis. The latch is located to the right of the power supply.



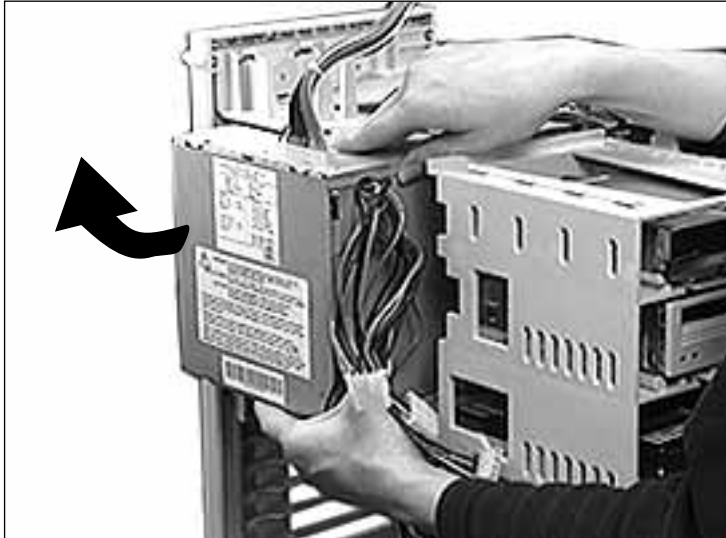

- 6 Slide the power supply forward and pull it out of the computer.
- 7 Remove the 22-pin cable from the power supply.

**Replacement Note:** There are two metal tabs on the back of the power supply on its bottom edge. You must feed these tabs through two openings in the chassis before you slide the power supply back into place.





## Speaker

Before you begin, remove the top housing.

**Note:** As you face the computer, the speaker is on top of the chassis at the back end of the computer.

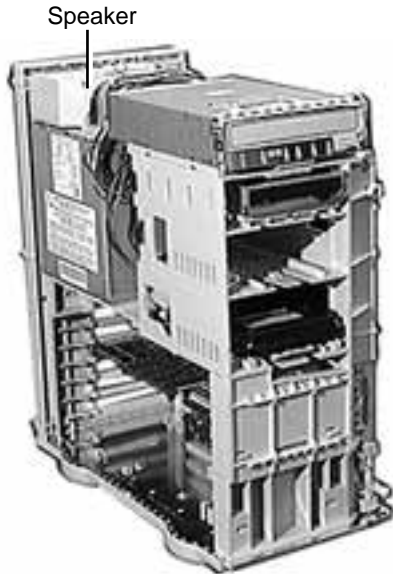



Speaker

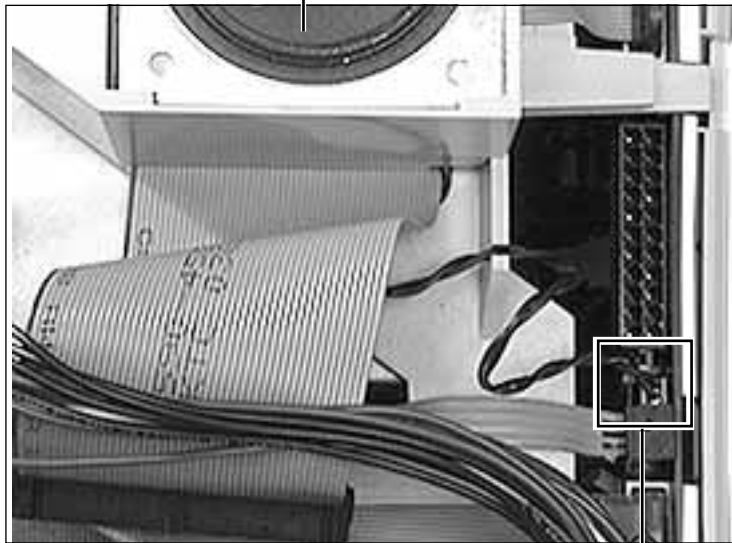

Speaker Cable

- 1 Disconnect the speaker cable from the logic board.



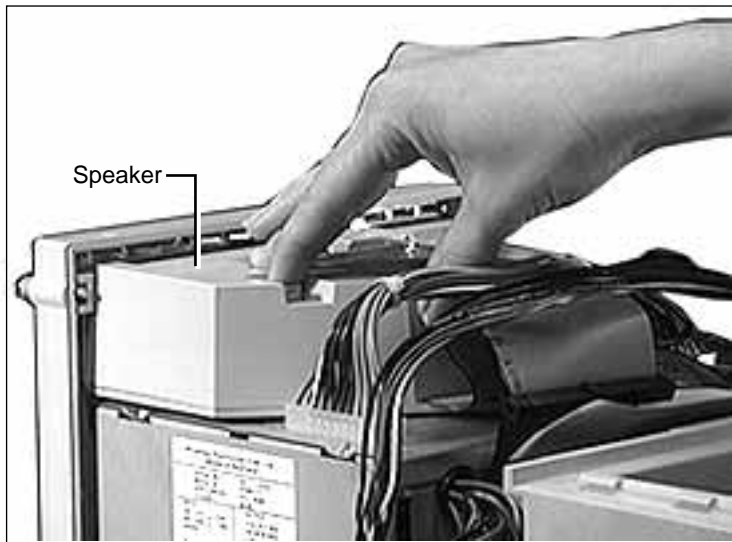

- 2 Press the latch holding the speaker housing to the chassis and lift the front of the speaker housing.





- 3 Pull the speaker housing from the clips at the rear of the chassis.

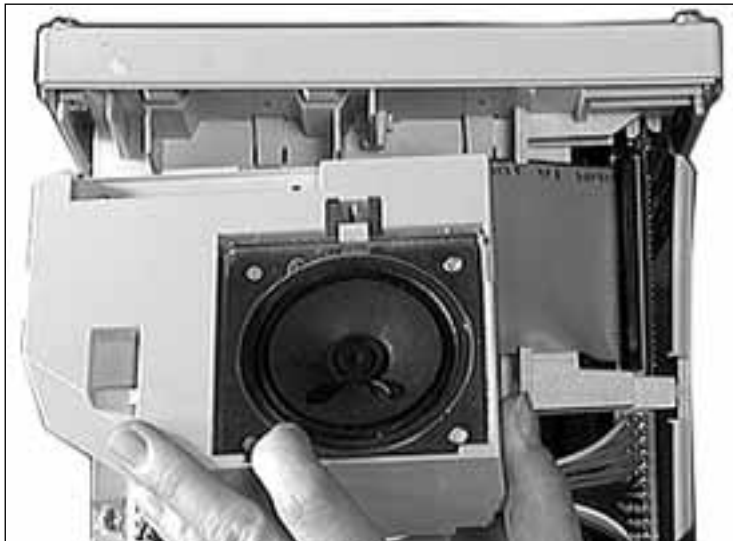



## Rear Panel

Before you begin, remove the following:

- Top Housing
- Speaker

**Note:** To locate the rear panel, turn the computer so the back faces you. The rear panel is the back part of the housing.



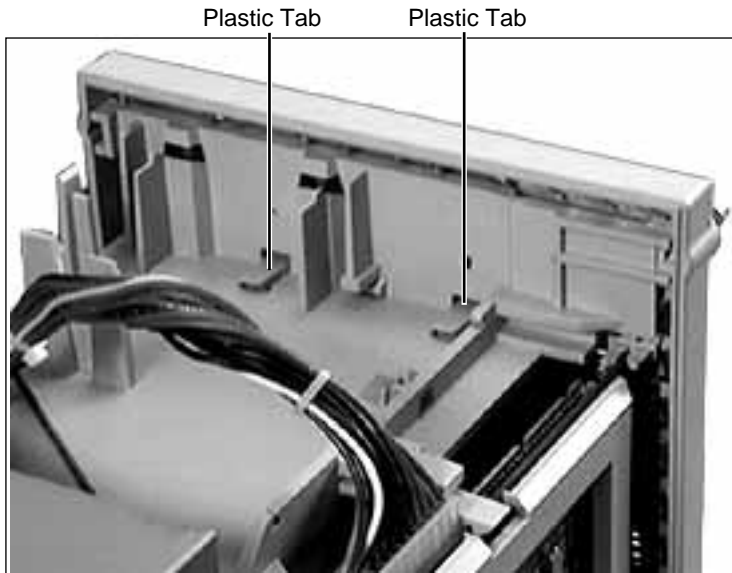

- 1 Two plastic tabs at the top of the rear panel secure the rear panel to the chassis. Lift the two tabs to release them.







- 2 Pull out on the rear panel and lift up slightly to release the two bottom tabs that secure the rear panel to the chassis.

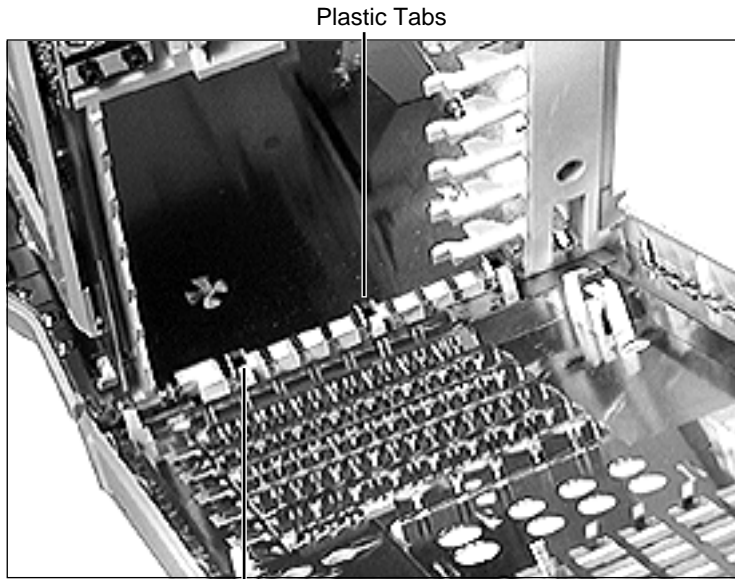

Plastic Tabs





## Processor Card

Before you begin, remove the following:

- Top Housing
- Fan

**Note:** As you face the computer, the processor card is plugged into the logic board on the left side, directly beneath the power supply.

**Note:** For better access, lay the computer on its side with the power supply facing up.

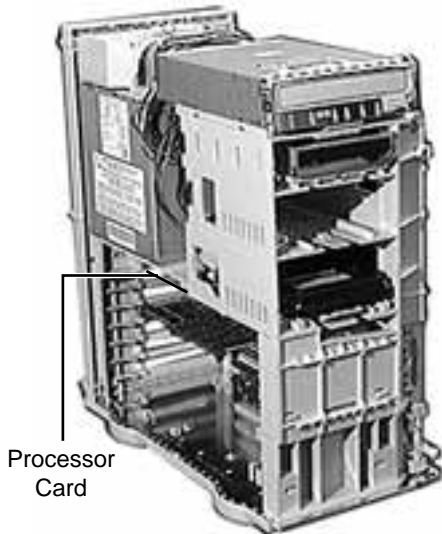

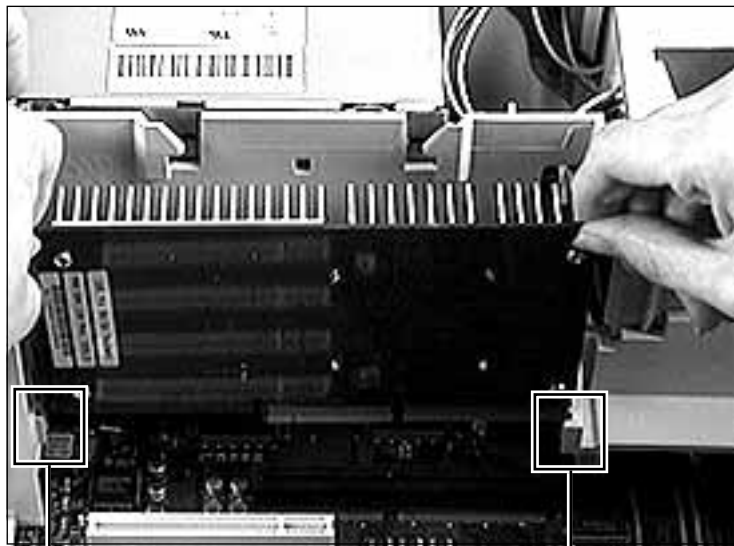

Plastic Guide

Plastic Guide

**Warning:** The heat sink may be hot to the touch.

- 1 Grab the corners of the processor card (and the top of the heat sink if it is cool to the touch) and pull straight up on the card to remove it.

**Replacement Note:** Position the bottom edges of the card in the plastic guides and press down on the card to install it. Do not force the card or you may damage it. Make sure the card is seated evenly.





## PCI/Video Cards

Before you begin, remove the following:

- Top Housing
- Fan

**Note:** As you face the computer, PCI cards (such as the Apple Accelerated Graphics card) plug into the logic board on the left side.

**Note:** For better access, lay the computer on its side with the power supply facing up.

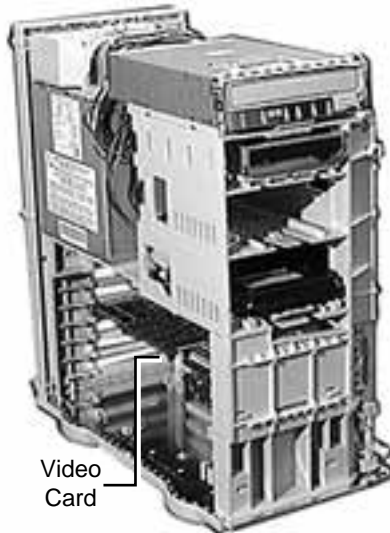

Video  
Card





- 1 Push apart the plastic latches that secure the PCI card to the chassis and pull up on the card to remove it.

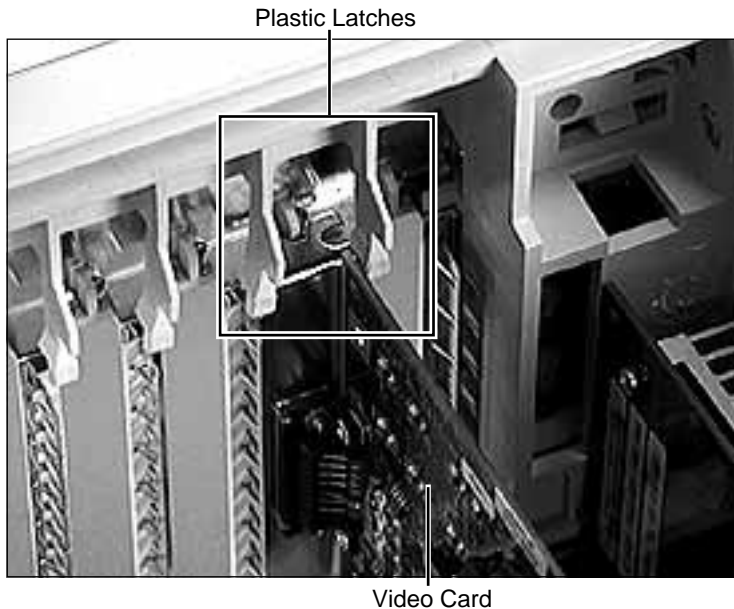

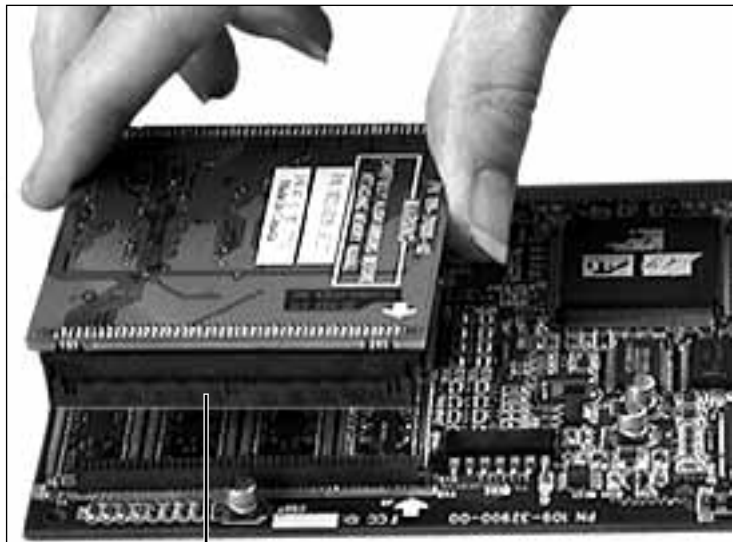

VRAM Upgrade Card

**Important:** If you are returning an Apple Accelerated Graphics card, you must first remove the third-party VRAM upgrade card if one is installed.

- 2 Grab the edges of the VRAM upgrade card and lift straight up on the card to remove it.



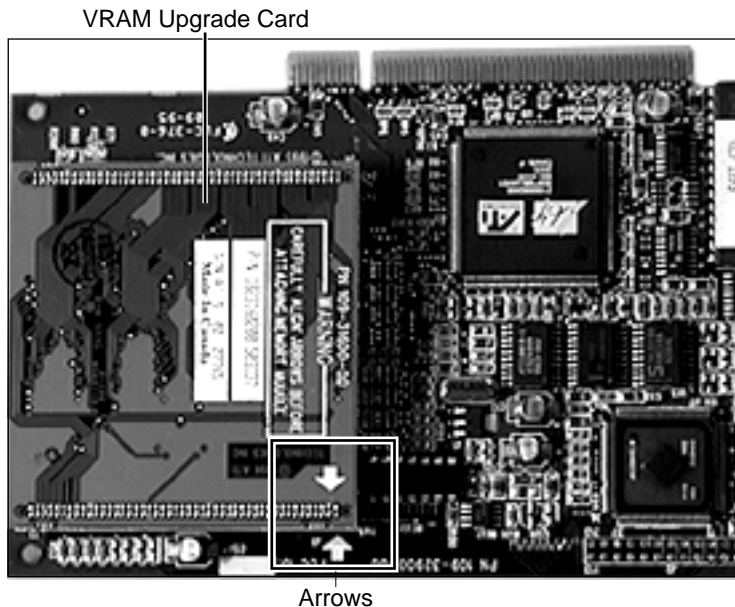

**Replacement Note:** To replace the third-party VRAM Upgrade card, line up the arrows on the two cards, as shown in the graphic on the left, and gently press down on the VRAM upgrade card. Do NOT force the upgrade card. If you encounter resistance, first make sure you have the card lined up properly, and try again.





## Logic Board

Before you begin, remove the following:

- Top Housing
- Fan
- Processor Card
- PCI/Video Cards (e.g., Apple Accelerated Graphics Card)

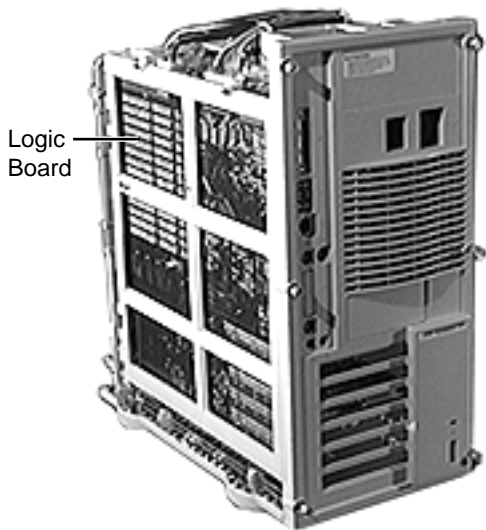

**Note:** As you face the rear of the computer, the logic board is on the left side and is perpendicular to the bottom chassis.





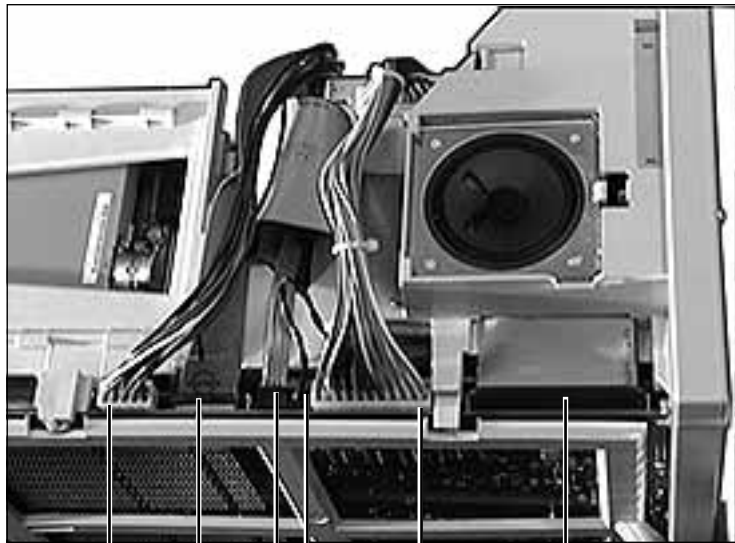

Power  
Supply  
Cable

Floppy  
Drive  
Cable

CD-Rom  
Audio  
Cable

Speaker  
Cable

Power  
Supply  
Cable

SCSI  
Cable

- 1 Disconnect all cables from the top of the logic board.



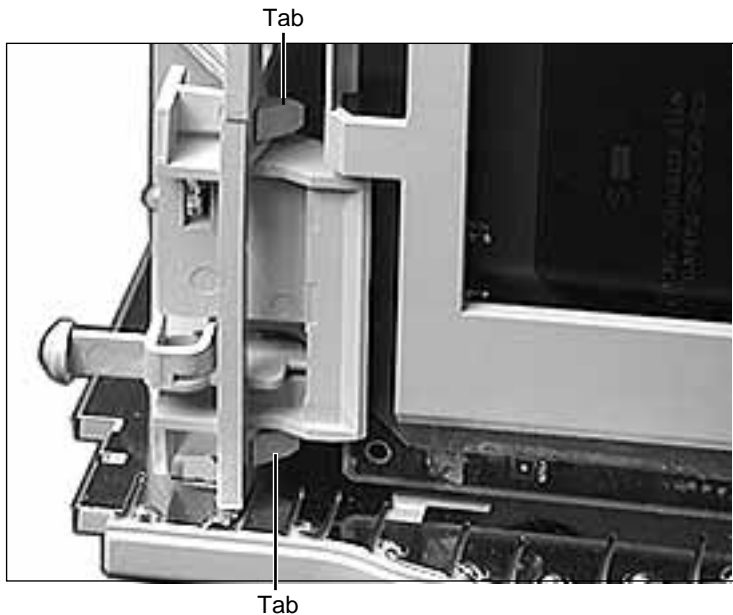

- 2 Locate the power actuator at the bottom of the logic board. Press in on the two plastic tabs to remove the actuator from the logic board.





- 3 Remove the screw securing the logic board to the chassis.

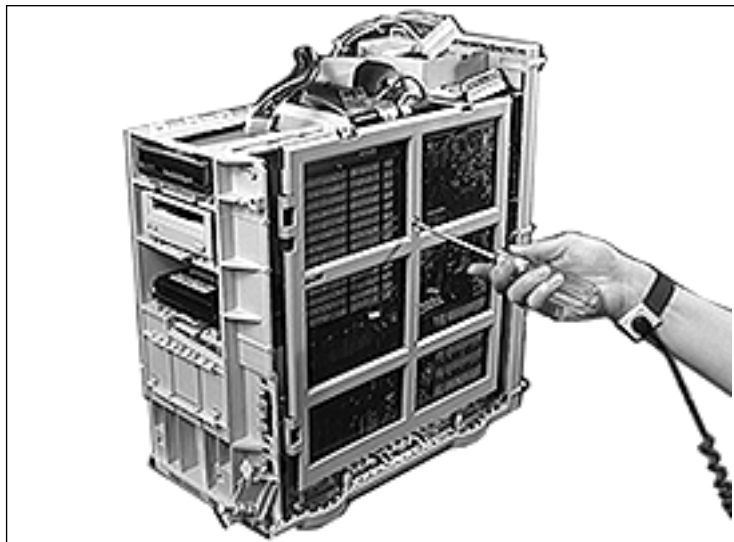



- 4 Slide the logic board forward until the slot indicated lines up with the latch on the chassis.

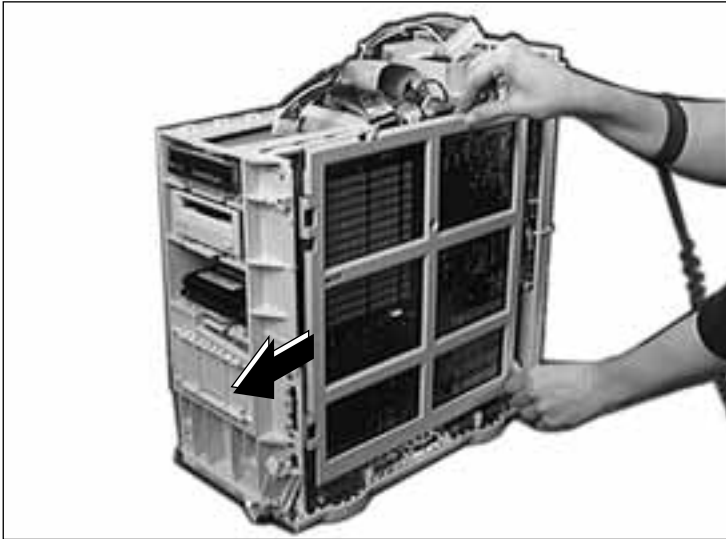



- 5 Lift the latch at the top of the logic board and release the logic board.





- 6 Pivot the front of the logic board out of the chassis to remove the board.

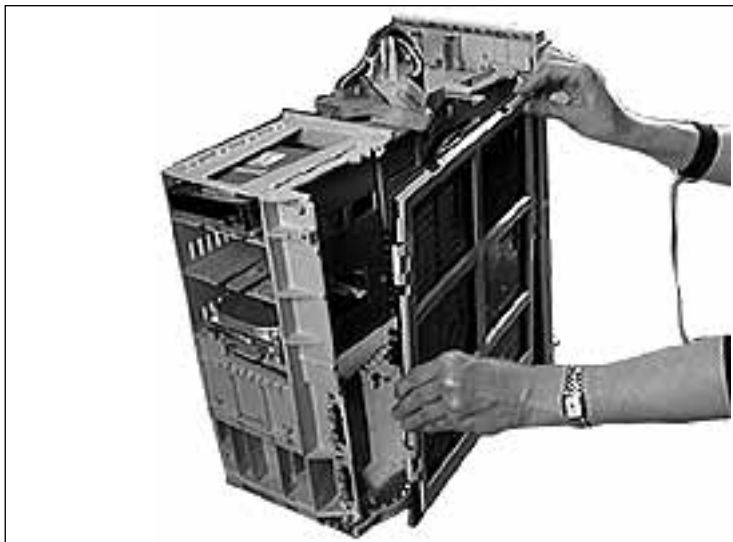



LED Connector

- 7 Disconnect the LED cable (which attaches to the power actuator) from the logic board.

**Note:** Remove the DRAM DIMMs before returning the board to Apple. Do NOT remove the ROM SIMM. Refer to the Module Identification manual to identify the ROM SIMM and DRAM DIMMs.

**Note:** There is a double click seating process for installing DRAM DIMMs. Be sure to push the DIMMs all the way into the DIMM slots.





## Fan

Before you begin, remove the top housing.

**Note:** As you face the computer, the fan is on the left side and attaches to the bottom chassis.

**Important:** After you replace the fan, be sure to plug it back into the logic board.

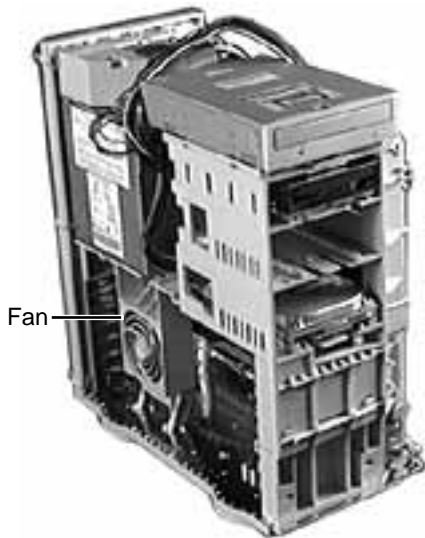





- 1 Disconnect the fan cable from the logic board.

Fan Connector



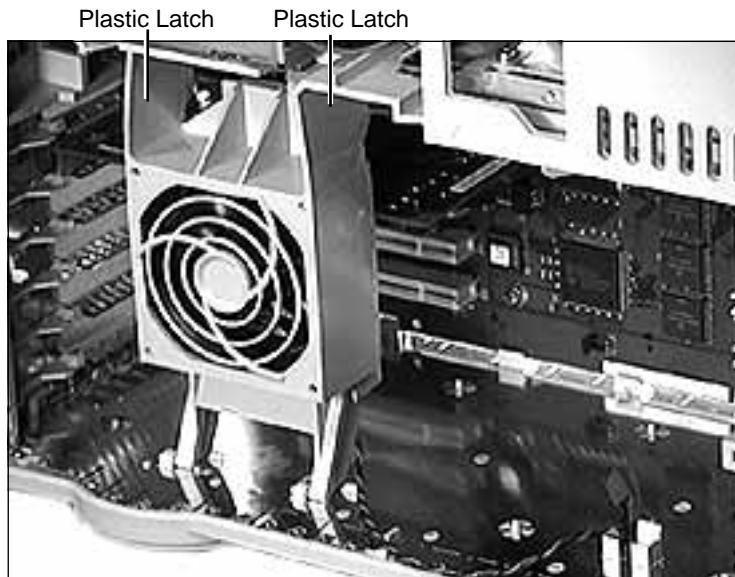

- 2 Squeeze in on the two plastic latches at the top of the fan bracket and pull down on the fan.





- 3 Push the fan to the right to release it from the plastic stays and remove the fan.

**Replacement Note:** Hold the fan at a 90° angle to the chassis (as shown). Fit the fan's bottom plastic pins into the plastic stays on the chassis and swing the fan upright to install it.

**Important:** Be sure to plug the fan back into the logic board.





Upgrades

---

Power Macintosh 9500 Series





## PC Compatibility Cards

There are three Apple PC Compatibility cards that can be installed in the Power Macintosh 9500 Series computers:

- 7" 100 MHz PC Compatibility Card
- 12" 100 MHz PC Compatibility Card
- 12" 166 MHz-P PC Compatibility Card

For more information about these cards and installation instructions, refer to the PC Compatibility Card manual on this Service Source CD.





Exploded View

---

Power Macintosh 9500 Series



