

iBook G4 (14-inch Mid 2005)

Updated September 9, 2005



Take Apart
iBook G4 (14-inch Mid 2005)



General Information



Overview

To distinguish this computer from previous iBook models, note these characteristics:

- Mac OS X version 10.4 operating system
- Sudden Motion Sensor (SMS)
- 512 MB RAM standard on all configurations
- No more CD ROM on any configuration
- Built-in AirPort Extreme and Bluetooth combined on one card

Important: The only noticeable physical difference between this model and the earlier G4 model is the appearance of the foot sockets. Check the foot sockets on the bottom case to see this difference. For this model, the foot sockets are uniformly flat with no "dimples." However, the foot sockets are compatible with earlier models, so this physical difference is not an absolute indicator of the model type. Be sure to confirm the model type using serial number verification.

iBook G4 (Early 2004): Foot sockets include three "dimples"



iBook G4 (Late 2004 and Mid 2005): Foot sockets are uniformly flat



The ports on the left side of the computer are the same as the previous G4 model:

- RJ11 modem port
- Ethernet port
- FireWire port
- Two USB ports
- External display connector
- Headphone port



This table shows the product configurations at initial product introduction:

Configuration	Good*	Best
Display Size	12.1 inch	14.1 inch
Video RAM	32 VRAM	32 VRAM
Processor	1.33 GHz	1.42 GHz
Optical Drive	Combo (DVD-ROM/CD-RW)	SuperDrive
Hard Drive	40 GB Ultra ATA (60, 80, or 100 GB CTO)	60 GB Ultra ATA (80 GB or 100 GB CTO)
Memory	512 MB RAM built in (up to 1.5 GB DDR 333 SDRAM CTO)	512 MB RAM built in (up to 1.5 GB DDR 333 SDRAM CTO)
AirPort Extreme/ Bluetooth	card installed	card installed
Sudden Motion Sensor (SMS)	yes	yes

* For servicing the 12.1-inch model, refer to the iBook G4 (12-inch Mid 2005) service manual.

Procedures

If you are familiar with taking apart iBook G4 computers, you will notice some service differences with this iBook model:

- AirPort and Bluetooth functions are combined on one card that is located under the top shield.
- The procedures for the RAM shield, cables, hard drive, reed switch, and heatsink differ somewhat from earlier models.
- The number and types of screws differ somewhat from previous models.

Note: The top and bottom EMI shields are marked with screw identifiers for most of the screw locations. The screw identifiers are in the form of "M2x_" where the last digit indicates the approximate screw length. For example, a marking of "M2x3" indicates a 3.5-mm long screw. Use the identifiers as a guide when reassembling the computer.

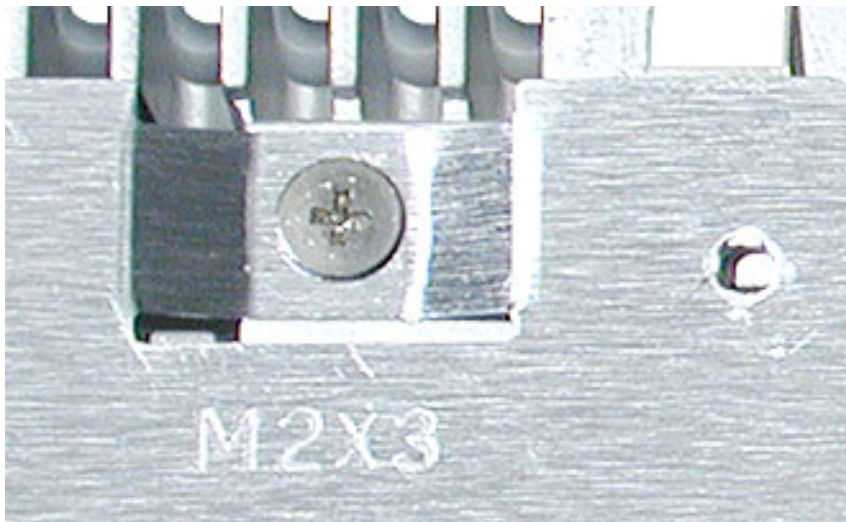

Tools

The following tools are recommended for the Take Apart procedures:

- Coin
- ESD wriststrap and mat
- Pin
- Magnetized #0 Phillips screwdriver
- Jeweler's flat-blade screwdriver
- Soft cloth
- Torx T8 screwdriver
- 2.0-mm hex driver
- #4 hex nut driver
- Needlenose pliers
- Torx T6 screwdriver
- 5/32 hex driver
- Black stick (or other nonconductive nylon or plastic tool)

Note: To organize the screws you remove from the assembly, use a tray with divided compartments (such as a plastic ice cube tray).

Serial Number Location

In this computer, the product serial number is located in two places: the battery bay and the top case underneath the keyboard.



Battery

Tools

The only tool required for this procedure is a coin.

Part Location



Preliminary Steps

Warning: Always shut down the computer before opening it to avoid damaging its internal components or causing injury. After you shut down the computer, the internal components can be very hot. Let the computer cool down for 30 minutes before continuing.

Procedure

Warning: If the computer has been recently operating, allow it to cool down before performing this procedure.

1. Place the computer on a clean, flat surface.
2. Shut down the computer and wait thirty minutes before continuing.
3. Disconnect the power cord and any other cables connected to the computer.
4. Close the computer, turn it over, and locate the battery latch.

Use a coin to turn the battery latch 1/4 turn clockwise to unlock the battery. Gently remove the battery.

Removing the battery will prevent you from accidentally turning on the computer.

Warning: Removing the battery before shutting down the computer may result in data loss.



5. Install the replacement battery.
6. Reconnect the power cord and any other cables that were connected and restart the computer.

Note: You may need to reset the date and time (using the Date & Time control panel in System Preferences).

Warning: Never turn on the computer unless all of its internal and external parts are in place and it is fully reassembled. Operating the computer when it is missing parts can damage the computer or cause injury.



Foot and Foot Socket

Tools

- Foot kit (for installing the replacement feet)
- Soft cloth
- Pin
- Needlenose pliers
- #0 Phillips jeweler's screwdriver or black stick (or other nonconductive nylon or plastic tool)

Caution: To avoid scratching the case, use caution when using tools to remove and replace the foot and foot socket.

Part Location



Preliminary Steps

Warning: Always shut down the computer before opening it to avoid damaging its internal components or causing injury. After you shut down the computer, the internal components can be very hot. Let the computer cool down for 30 minutes before continuing.

Procedure

Caution: To avoid scratching the case, use caution when using tools to remove and replace the foot.

1. Place the computer on a clean, flat surface or soft cloth.
2. Use a pin in the area shown to wedge the rubber foot off of the socket.



Note: If a portion of the rubber foot remains on the bottom case, use tweezers or needlenose pliers to carefully remove it.

-
3. Use a screwdriver to remove the screw and socket from the bottom case.
 4. Repeat for the remaining two feet if you are replacing them or removing the bottom case.



Replacing the Feet and Sockets

1. Install the new socket. For the best fit, do not reuse the old socket.

Replacement Note: When replacing the socket, notice the wedge area on the bottom of the socket and the matching wedge area in the bottom case. Position the socket in the bottom case to align the wedge areas. You might need to rotate the socket slightly until it sits flat into the bottom case.

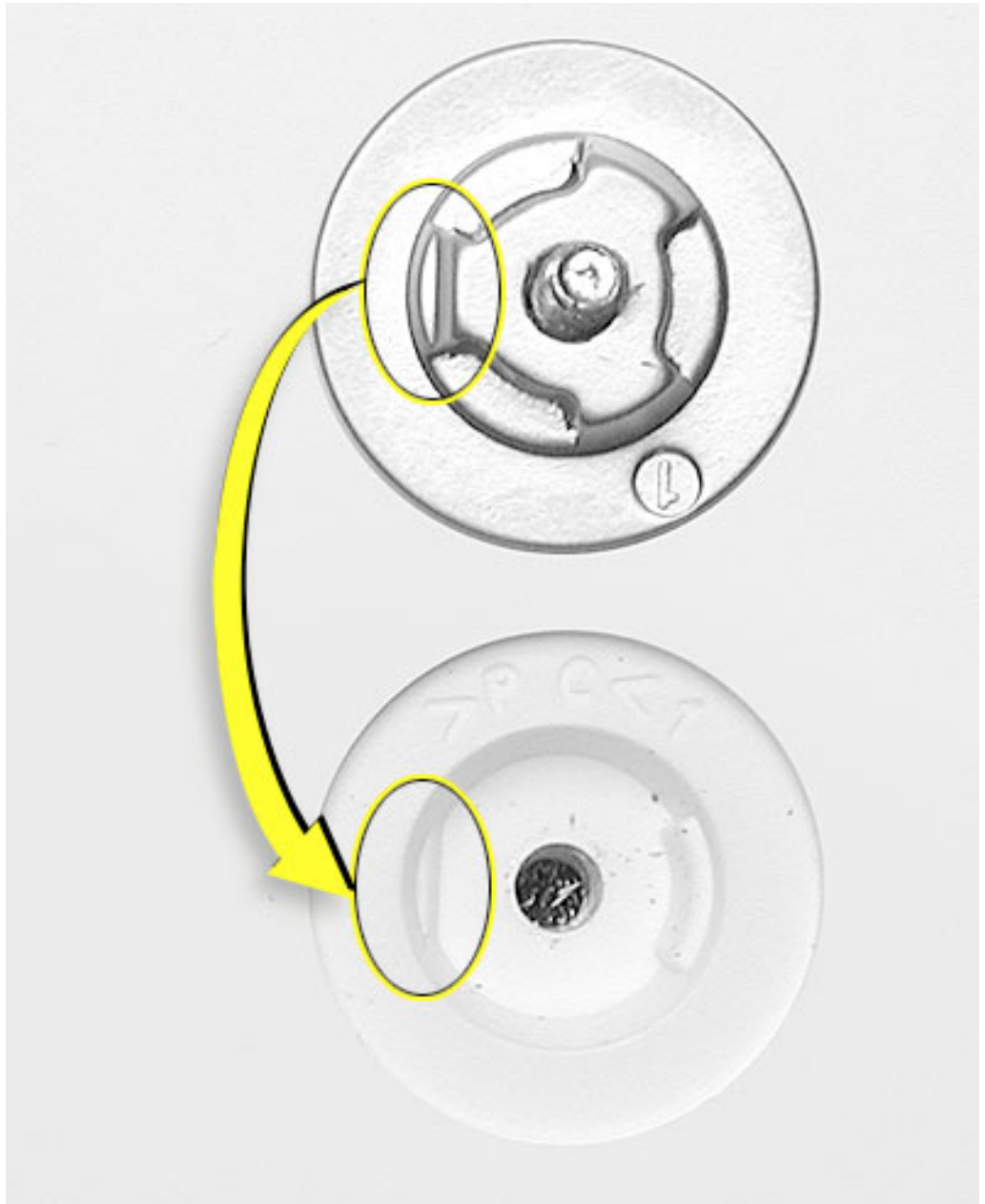

-
2. With the socket sitting flat in the bottom case, install the screw.
 3. Before installing the replacement foot, check the shape. The socket and foot are keyed:
 - The socket has three identical openings and a fourth indented area.
 - The foot has three identical raised areas and a fourth smaller raised surface.



4. Install the matching foot by aligning it to the matching areas in the socket. With gentle even pressure, press the foot onto the socket.
5. Reassemble and test the computer.



Keyboard and RAM Shield

Tools

- #0 Phillips screwdriver
- Jeweler's flat-blade screwdriver (if keyboard is locked)
- Small soft cloth

Part Location



Preliminary Steps

Before you begin, remove the battery.

Procedure

1. Raise the display so you can access the keyboard.
2. Make sure the keyboard locking screw, located in the small plastic tab next to the Num Lock key, is not in the locked position. The iBook comes with the keyboard unlocked, so unless you or someone else locked the keyboard, you can skip this step.

To unlock the keyboard, turn the screw 1/2 turn.

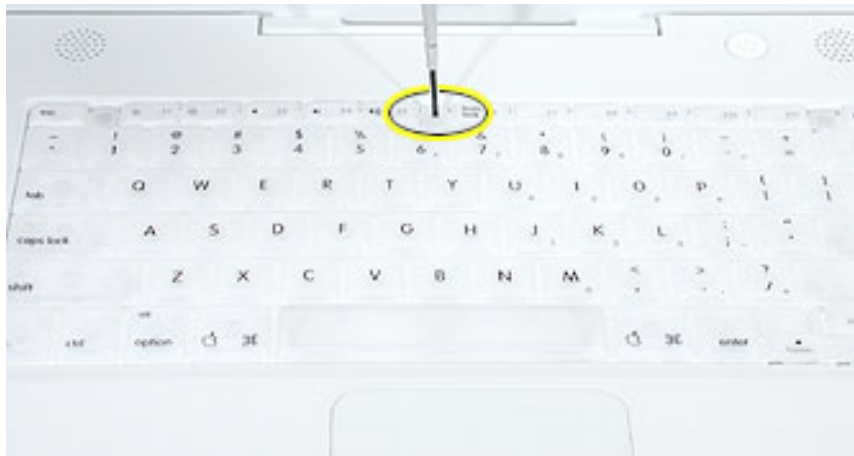

3. Release the keyboard by pulling down on the keyboard release tabs (located to the left of the F1 and F12 keys), then lift the top portion of the keyboard up slightly, and toward the display.



4. Flip the keyboard over and lay it on the palm rest.

Note: Two magnets under the keyboard help anchor it in place, so you might feel resistance when you tilt it up.



5. Touch a metal surface on the inside of the computer to discharge any static electricity, as shown.

Important: To avoid electrostatic discharge damage, always ground yourself by touching the computer's framework before you touch any parts or install any components inside the computer. To avoid static electricity building back up in your body, do not walk around the room until you have completed the installation and closed the computer.



6. Loosen the four captive screws that secure the RAM shield.

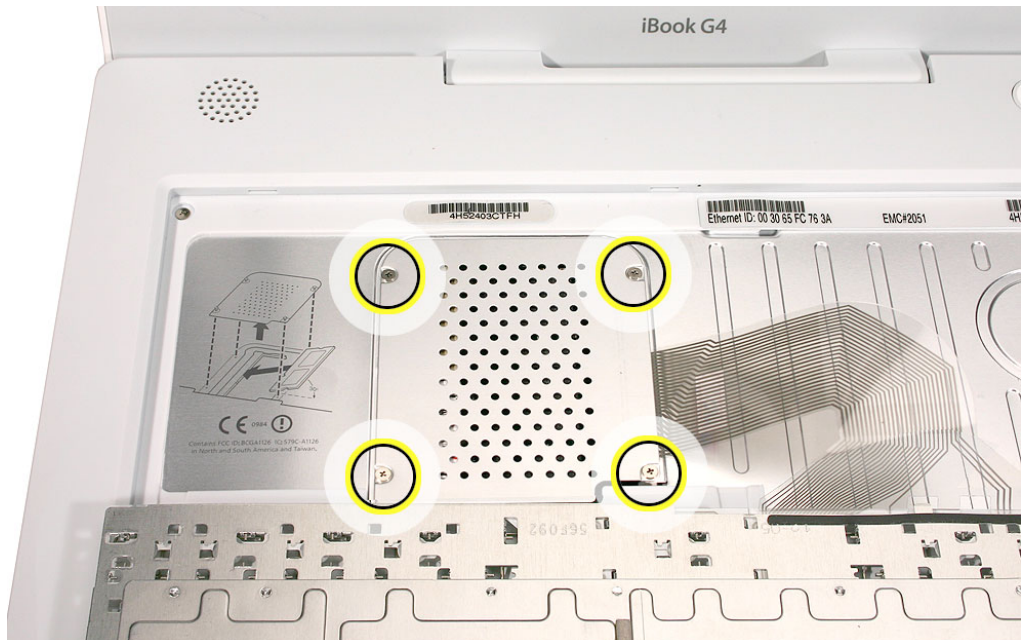

7. Lift the RAM shield out of the computer.

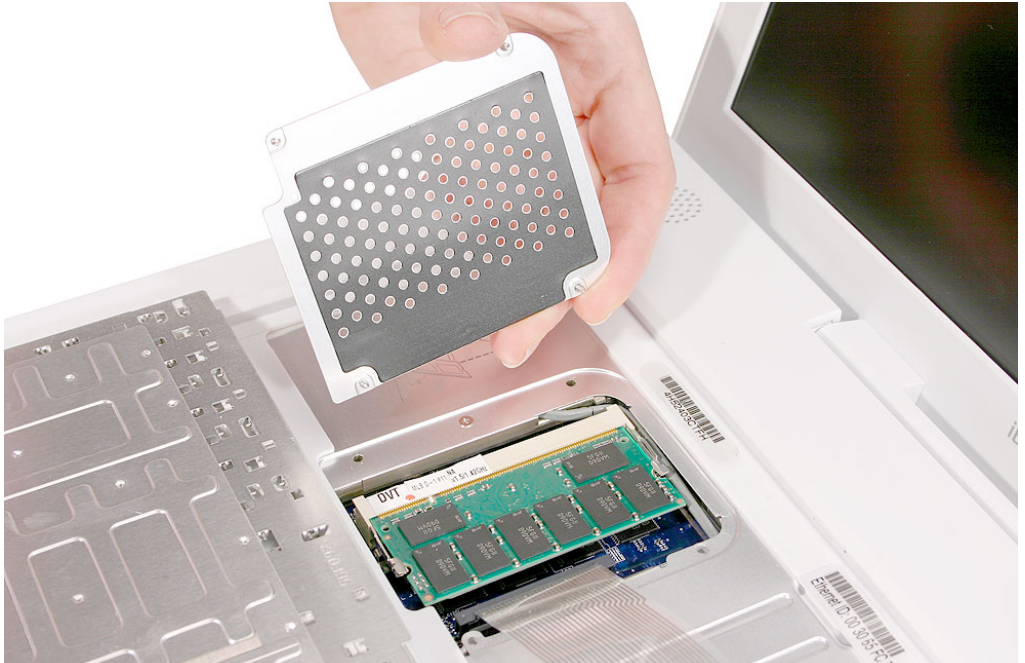

8. Locate the keyboard cable connector.
 9. Firmly grasp the cable, and carefully pull it straight up until the connector releases.
- Important:** Pull straight up; do not twist or pull the cable sideways.
- Note:** If necessary, use your fingers to pry up the connector from side to side.

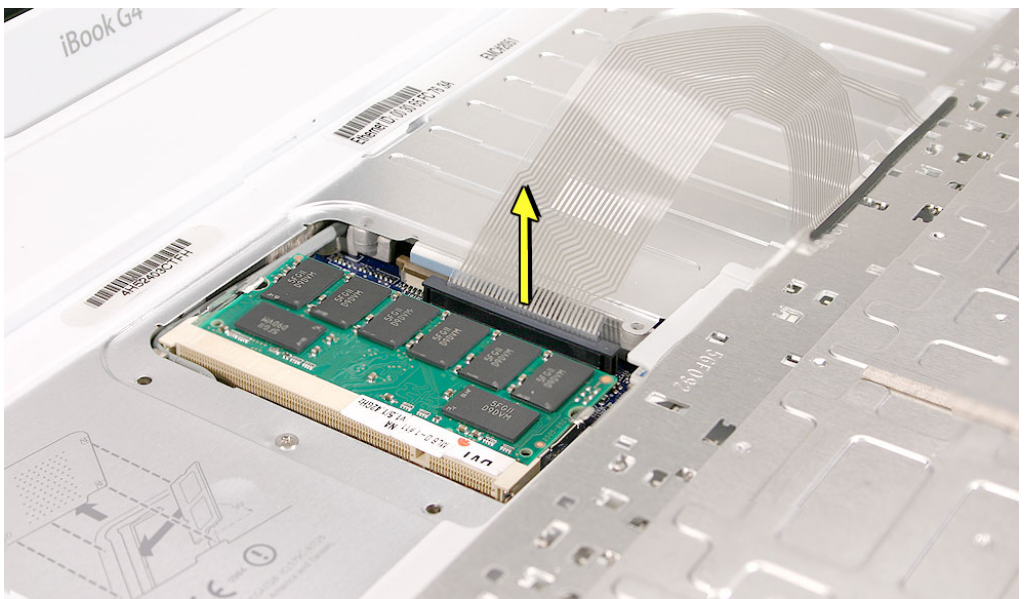

10. Install the replacement keyboard and RAM shield.

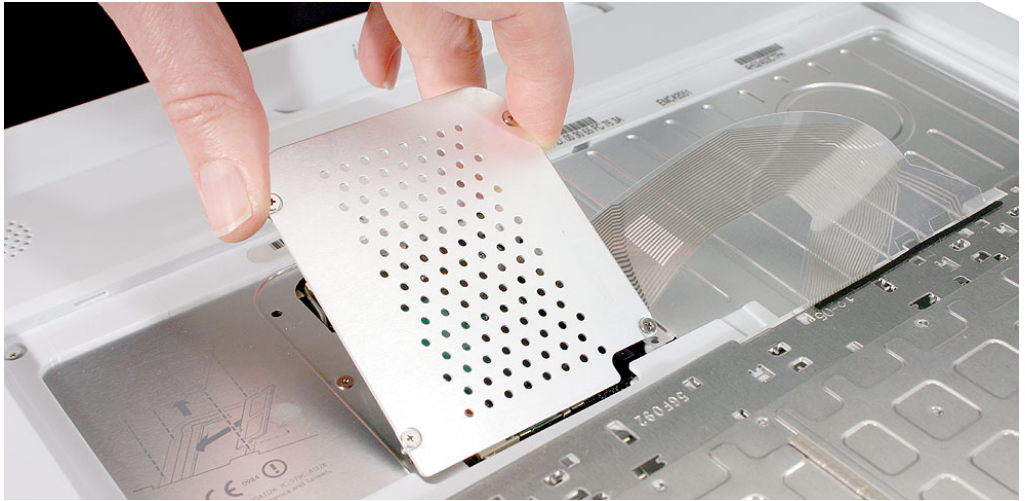

Make sure the replacement keyboard is firmly seated:

- Flip the keyboard back toward the keyboard opening in the case.
- Hold the keyboard at a 45-degree angle above the keyboard opening, and insert the tabs on the bottom edge of the keyboard into the slot under the edge of the opening.
- **Important:** Make sure that all the tabs are seated and that the keyboard rests flush against the edge of the opening.
- Lay the keyboard flat into the keyboard opening.
- Pull down on the keyboard release tabs and then press down on the top portion of the keyboard.





Memory Card

Warning: Memory cards come in various specifications. Only install memory cards that are approved for this computer.

Tools

No tools are required for this procedure.

Part Location

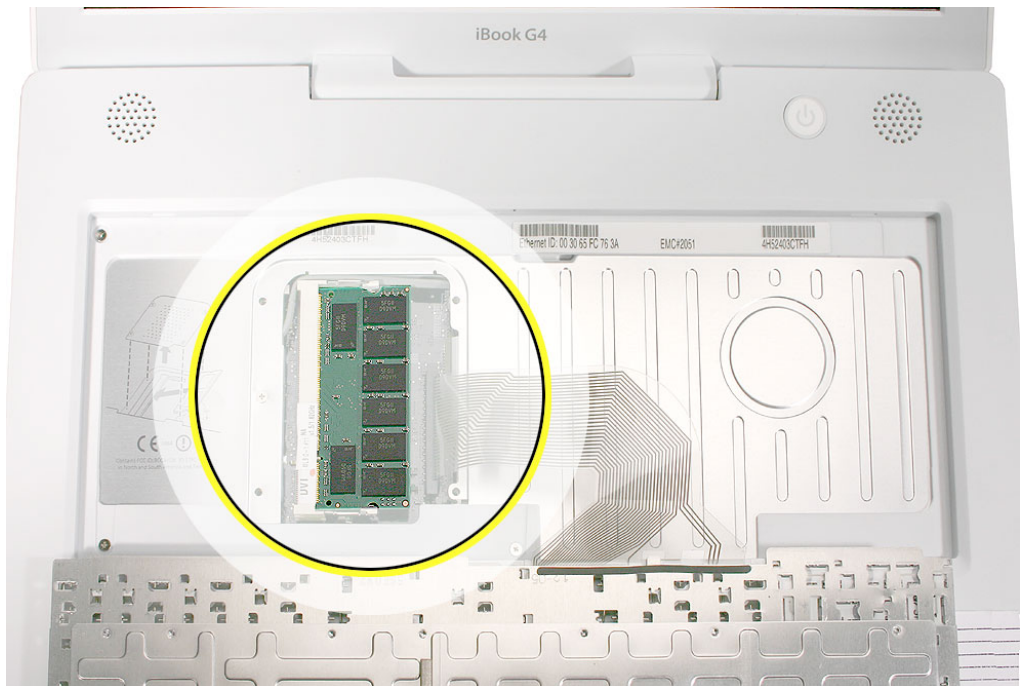

Preliminary Steps

Before you begin, remove the following:

- Battery
- Keyboard and RAM shield (but do not disconnect the keyboard cable)

Procedure

1. Locate the installed memory card and brackets that secure the card on both sides.
2. Carefully spread the brackets away from the notches in the card until the card releases on each side.

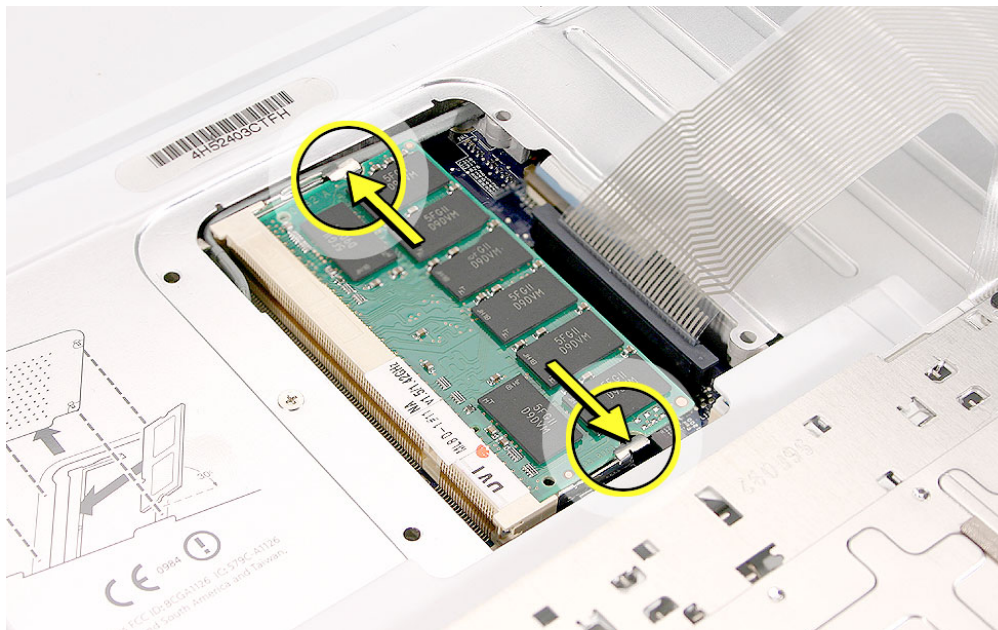

3. Holding the card by the top corners, pull the card up and out of the memory slot.

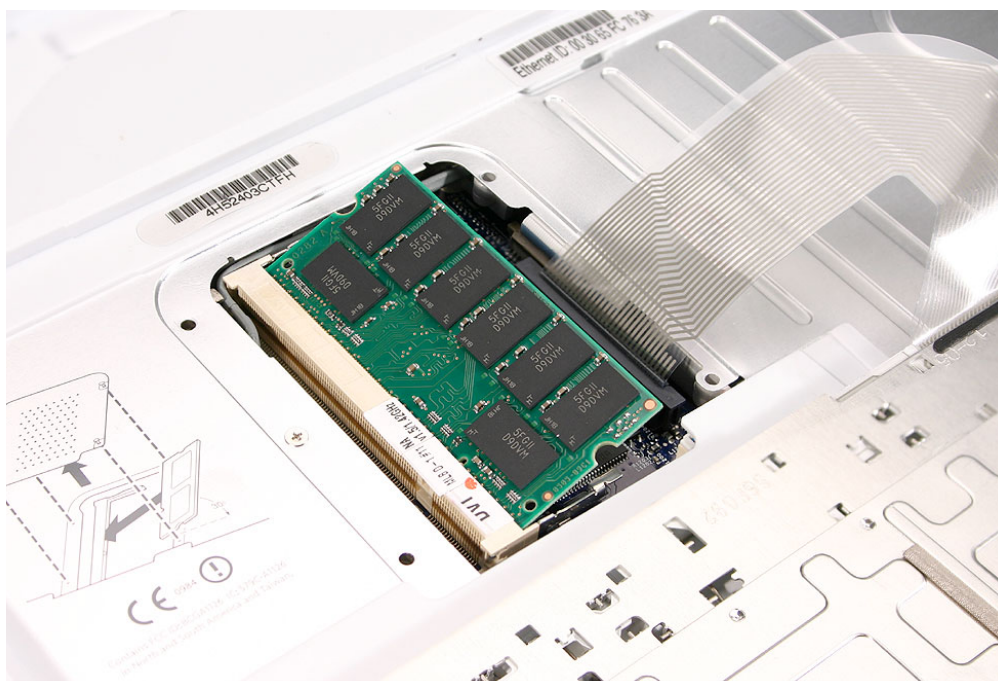

- Align the notch in the replacement memory card with the small tab in the memory slot. Hold the card at a 30-degree angle, then push the card into the slot until it is firmly seated.

Note: If you feel resistance when inserting the card, try pushing one side at a time.

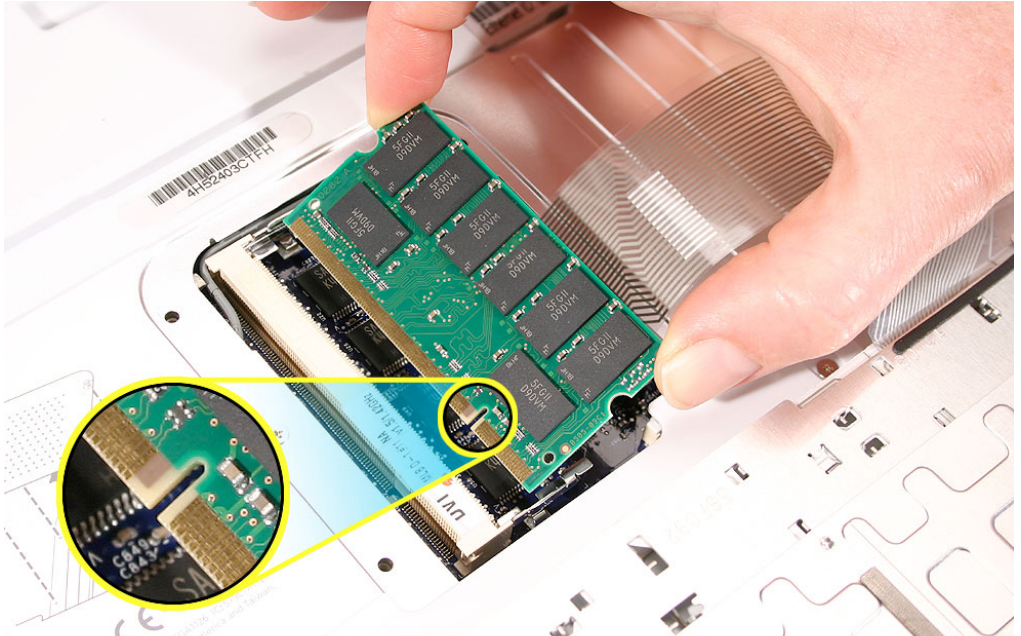

- Gently push the top of the card down until the brackets snap onto both sides of the memory card to lock it into place.

Warning: Apply gentle pressure to the memory card only. Pressing on nearby connectors or components can cause electrical damage.

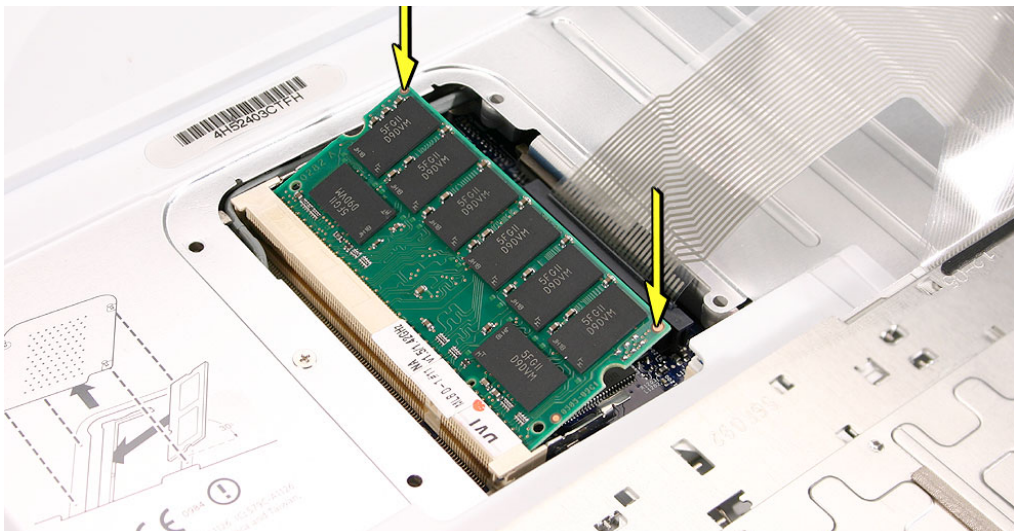

- Reassemble and test the computer.



Bottom Case

Tools

- Soft cloth
- Torx T8 screwdriver or 2.0-mm hex driver
- Black stick (or other nonconductive nylon or plastic tool)
- #0 Phillips screwdriver
- Jeweler's flat-blade screwdriver

Part Location



Preliminary Steps

Before you begin, remove the battery.

Procedure

1. Place the computer upside down on a soft cloth.
2. Using a pin, pry up the three rubber feet from the metal sockets.

Important: When reassembling the computer, do not reuse the feet. Install three new rubber feet.



3. Remove the three identical Phillips screws from the metal sockets.
4. Use a black stick to lift out the metal sockets.

Note: When reassembling the computer, note that the metal sockets are keyed. Rotate them until they sit flat against the bottom case. Align the feet so that the keyed area on the feet match with the socket.



5. **Important:** To avoid damaging the case, be careful that the screwdriver tip does not slip out of the screw head during removal. Remove the three screws.



6. Remove the two identical 4.5-mm long Phillips screws next to the battery connector.

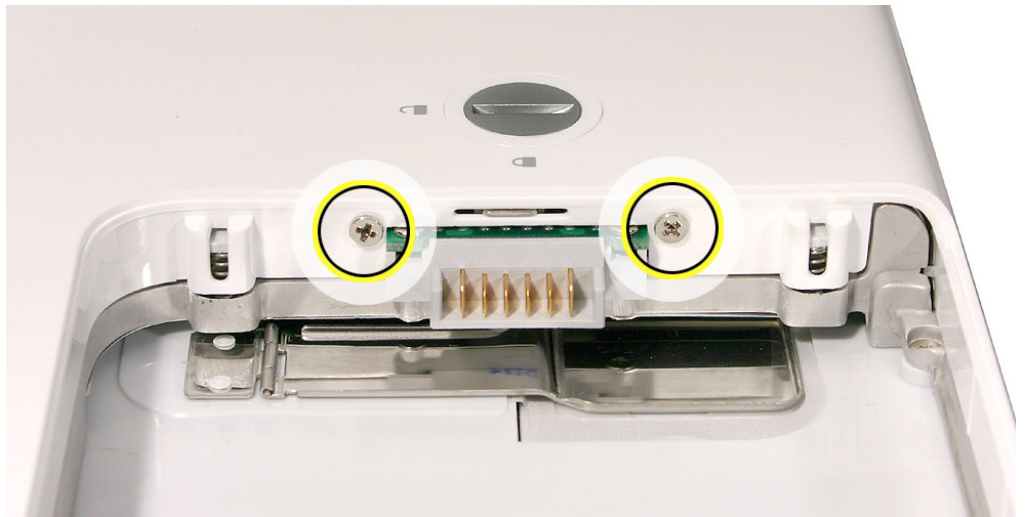

- Note the locations of the slots on the bottom case pictured below. The computer frame has tabs that fit into slots within the bottom case (six tabs in front; two on each side; three in back). When using a black stick to pry off the bottom case, it helps to know where the slots are as you free the tabs from the slots.



- Starting at the battery compartment, use a black stick to carefully pry up the bottom case from the computer.
- Warning: To avoid damaging the sleep light and other delicate components, do not insert the black stick too far into the computer as you free the bottom case from the computer. Use just the tip of the black stick to pry up the bottom case.**



-
10. Open the computer and place it on its side. Carefully work the black stick around the corners of the bottom case.

The bottom case fits snugly. Use moderate force to remove the tabs from the slots.



-
11. In the battery compartment, lift up the corner of the bottom case, and use a black stick or jeweler's flat-blade screwdriver to gently pry up the slot from the inner tabs on the frame.

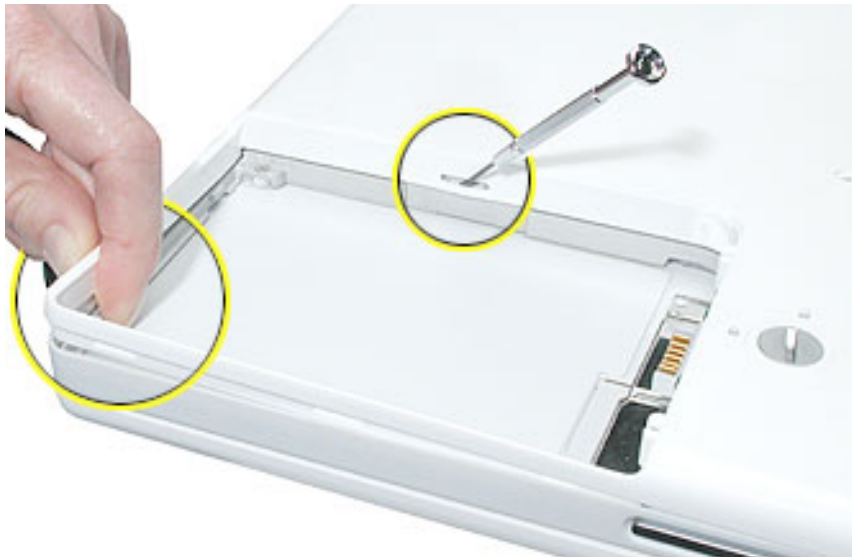

12. **Note:** For this procedure, a black stick works best.

Loosen the tabs from the slot load area last.

Pull up on the port side of the bottom case.

Placing the black stick nearly parallel to the slot drive opening, carefully free the case from the remaining tabs at the slot drive side of the computer.

Note: When reassembling the computer, be careful not to pinch any cables as you press the bottom case back onto the computer. Check that the bottom case shows no raised surfaces and is fully snapped into place before installing the remaining screws, sockets, and feet.

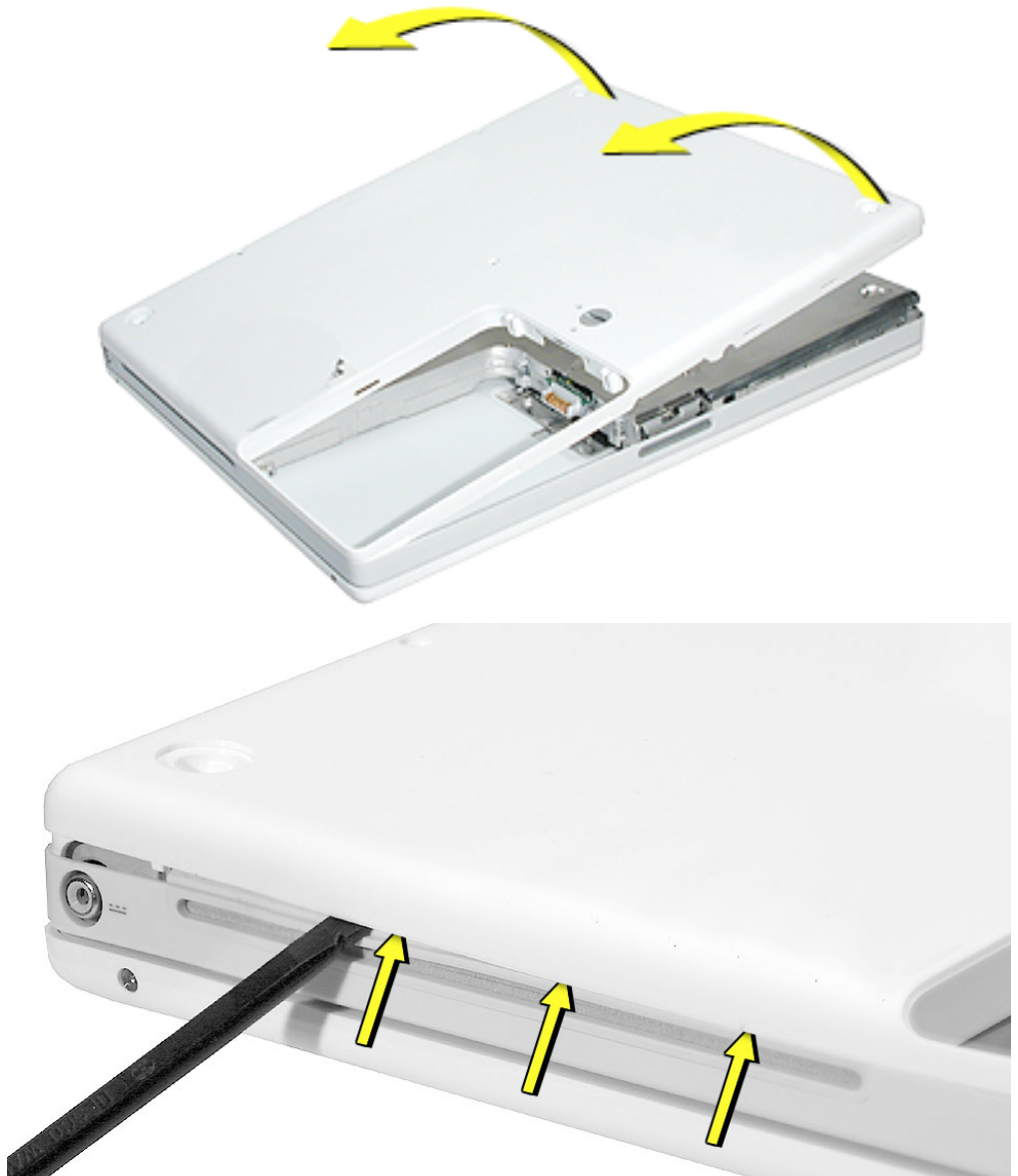

13. If you are replacing any additional parts at this time, remove the two springs from the battery compartment so they do not fall out and get lost.

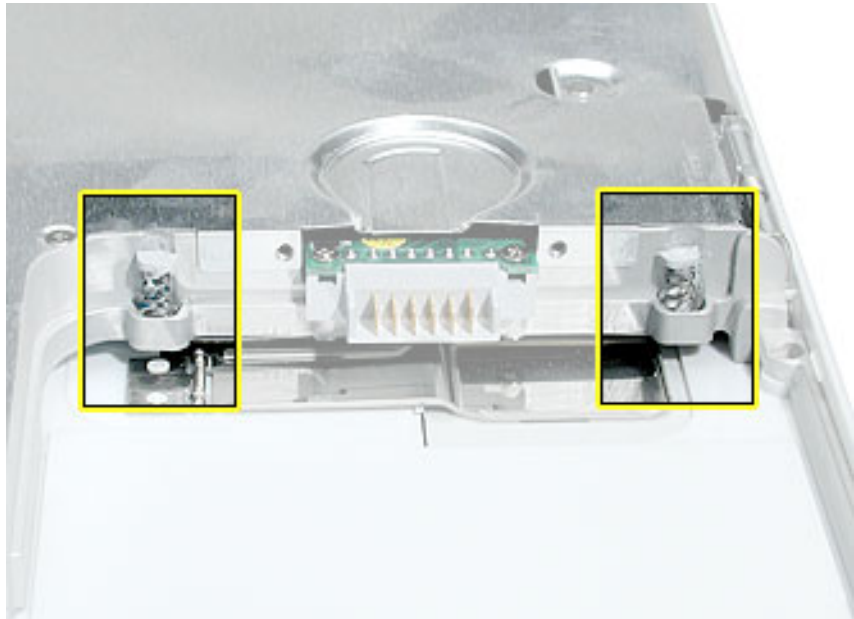

Note: When reassembling the computer, make sure that the two springs in the battery compartment are in place before installing the bottom case. Each spring has a plastic cap on one end. The cap should fit securely on the spring, and the curved side of the cap should be positioned against the inner frame. The springs have a small amount of grease on them; do not wipe away the grease.

14. Install the replacement bottom case, and reassemble and test the computer.



Bottom Shield

Tools

- Soft cloth
- #0 Phillips screwdriver
- Black stick (or other nonconductive nylon or plastic tool)

Note: To organize the screws you remove from the computer, use a tray with divided compartments (such as a plastic ice cube tray).

Part Location

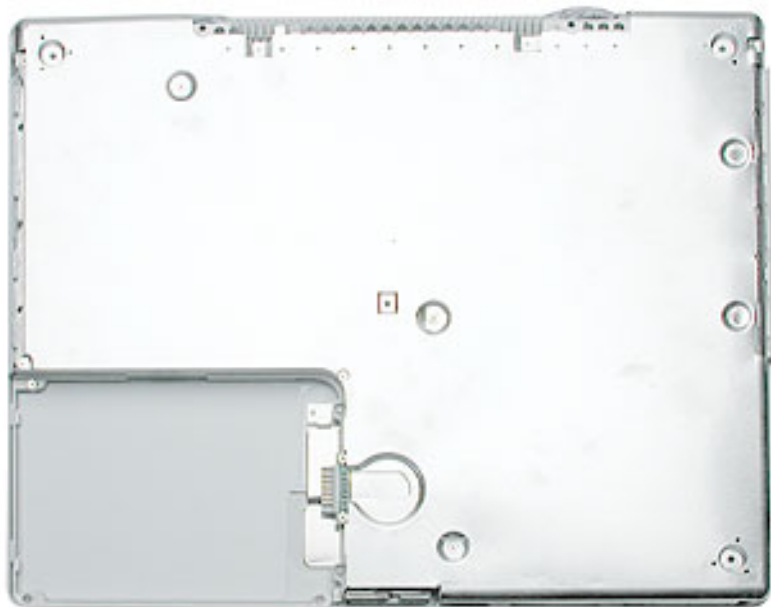

Preliminary Steps

Before you begin, remove the following:

- Battery
- Bottom case

Procedure

1. With the computer on a soft cloth, remove the following screws from the bottom shield:
 - Six identical 3.5-mm long Phillips screws
 - Three identical 7.5-mm long Phillips screws
 - One 14.5-mm long Phillips screw

Replacement Note: When reassembling the computer, install the replacement bottom shield so that the corner of the shield closest to the ports is secured first. (With the computer oriented as shown, this corner is the uppermost right corner.) When reinstalling the screws, install them in the order shown.

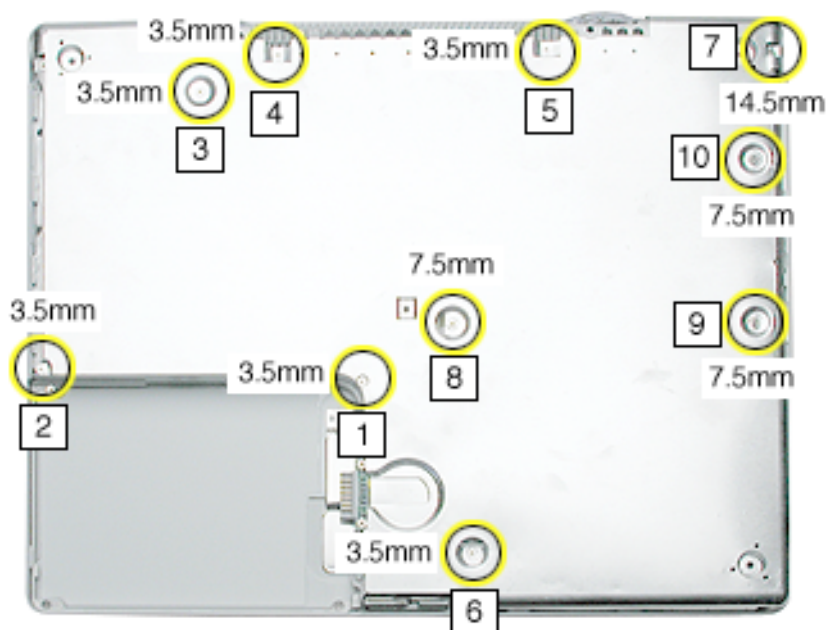

2. If tape is used on the bottom shield, peel up, but do not remove, any pieces of tape.

Note: When reassembling the computer, reuse the tape to secure the replacement bottom shield.

3. **Warning: Do not bend the bottom shield.**

Lift the bottom shield off the computer, being careful where it might catch on the tape.



4. **Note:** The two springs in the battery compartment can become loose. When reassembling the computer, make sure that the two springs are in place before installing the bottom case. Each spring has grease on the coils, and each has a plastic cap on one end. Make sure the cap fits securely on the spring, and the curved side of the cap is positioned against the inner frame.

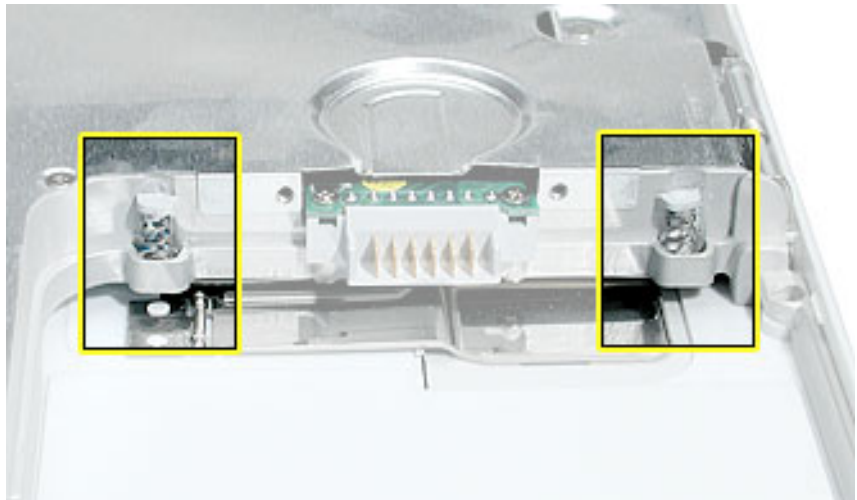

5. Install the replacement bottom shield, and reassemble and test the computer.

Replacement Note: Before installing the bottom shield, make sure cables are routed as shown.

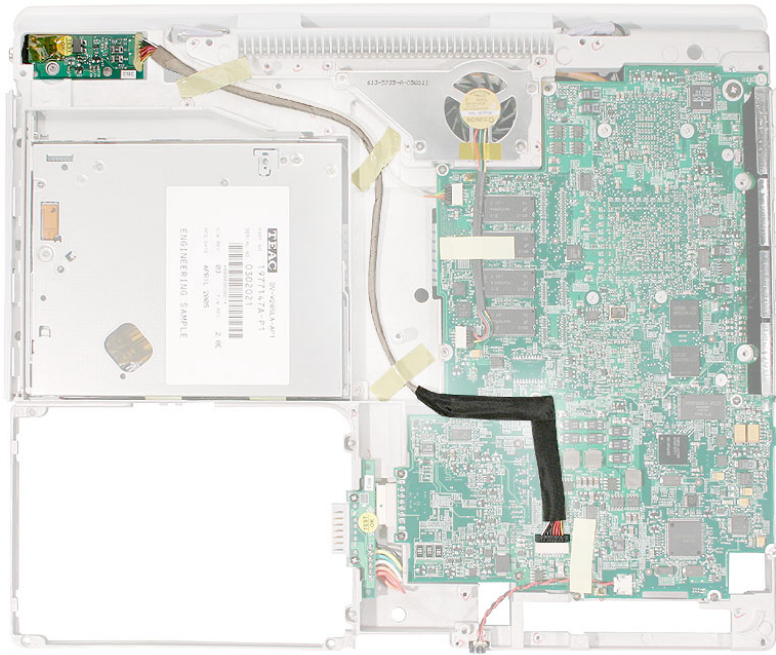



DC-In Board

Tools

- Soft cloth
- #0 Phillips screwdriver
- Black stick (or other nonconductive nylon or plastic tool)

Part Location

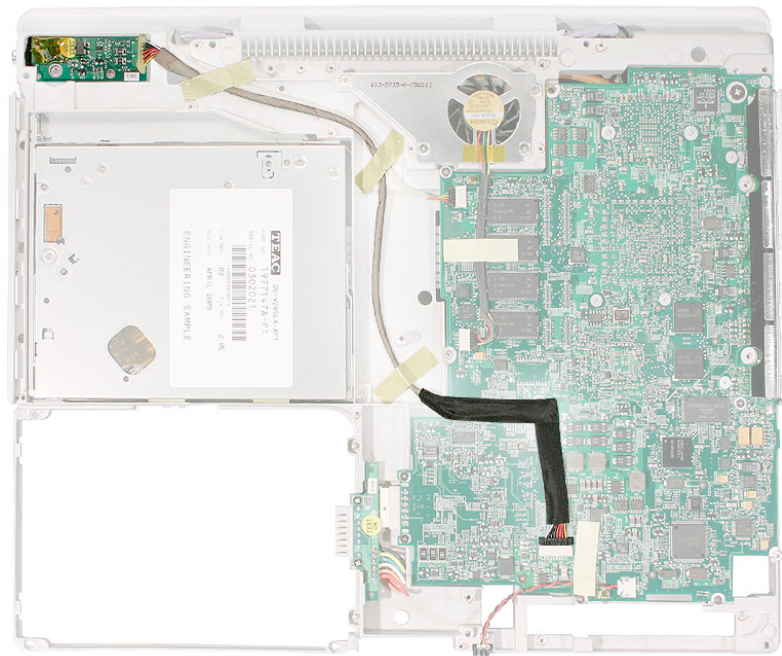

Preliminary Steps

Before you begin, remove the following:

- Battery
- Bottom case
- Bottom shield

Procedure

1. With the computer on a soft cloth, remove any tape that holds the cable to the frame or logic board.
2. Route the cable from the guides in the chassis.

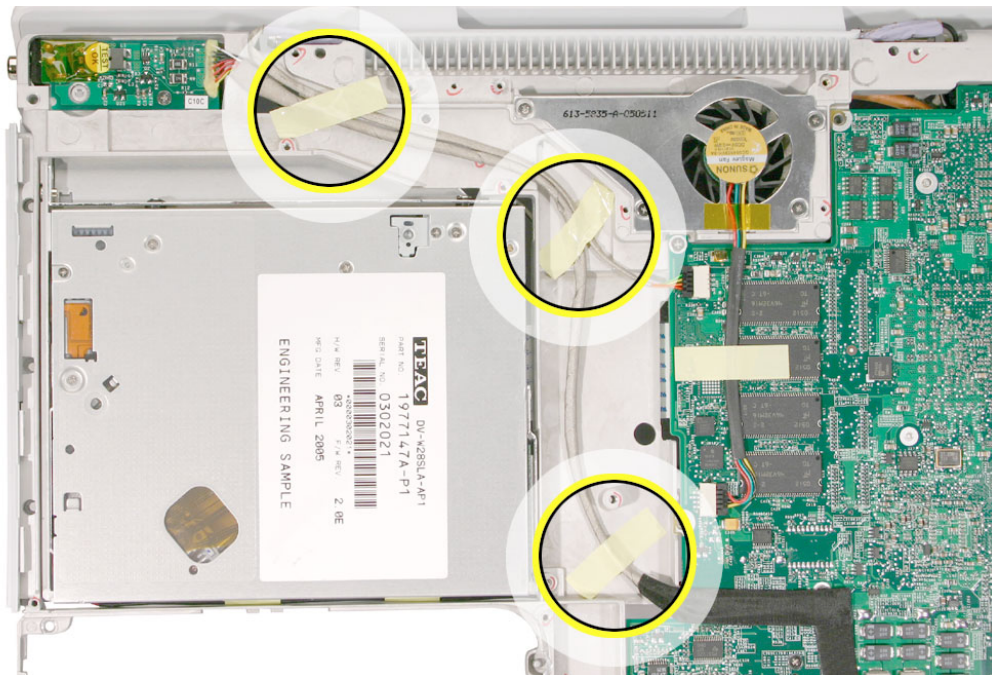

3. Remove the 3-mm long screw from the DC-in board.

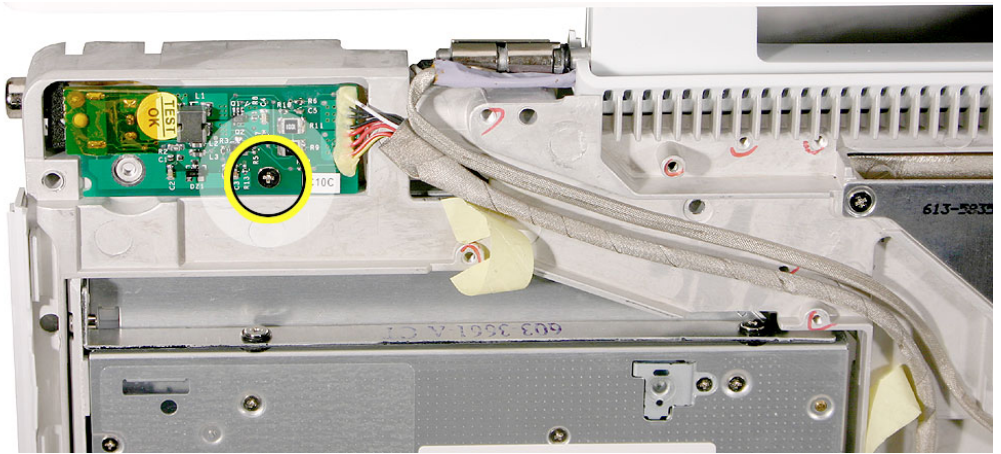

4. Tilt the DC-in board, and pivot it out of the frame.

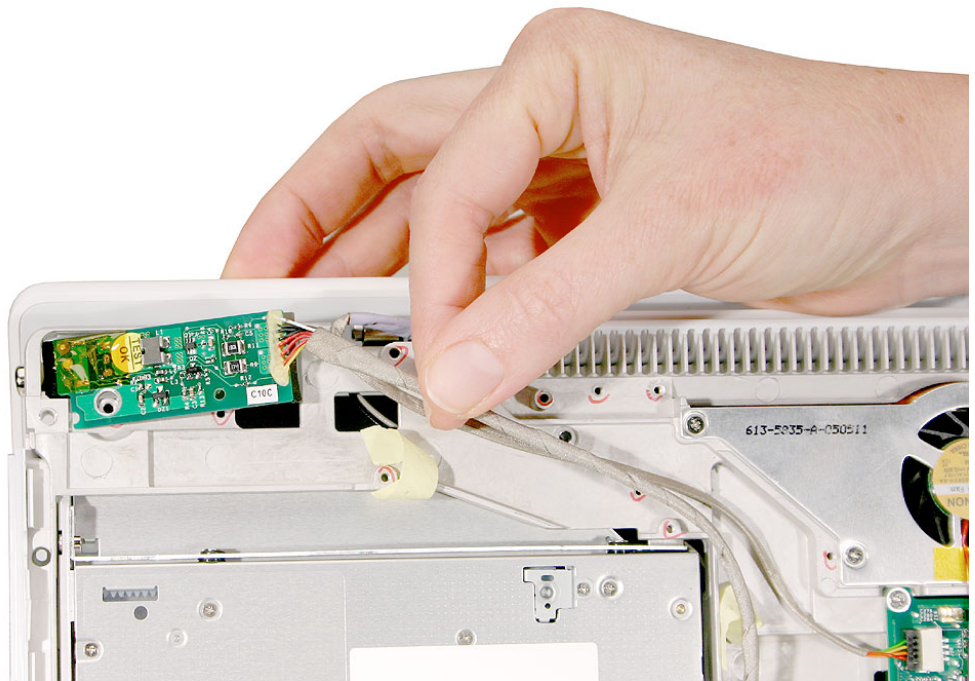

5. Carefully peel up the DC-in cable from where it adheres to the bottom of the logic board.

Caution: Do not forcefully pull or strain the cable.

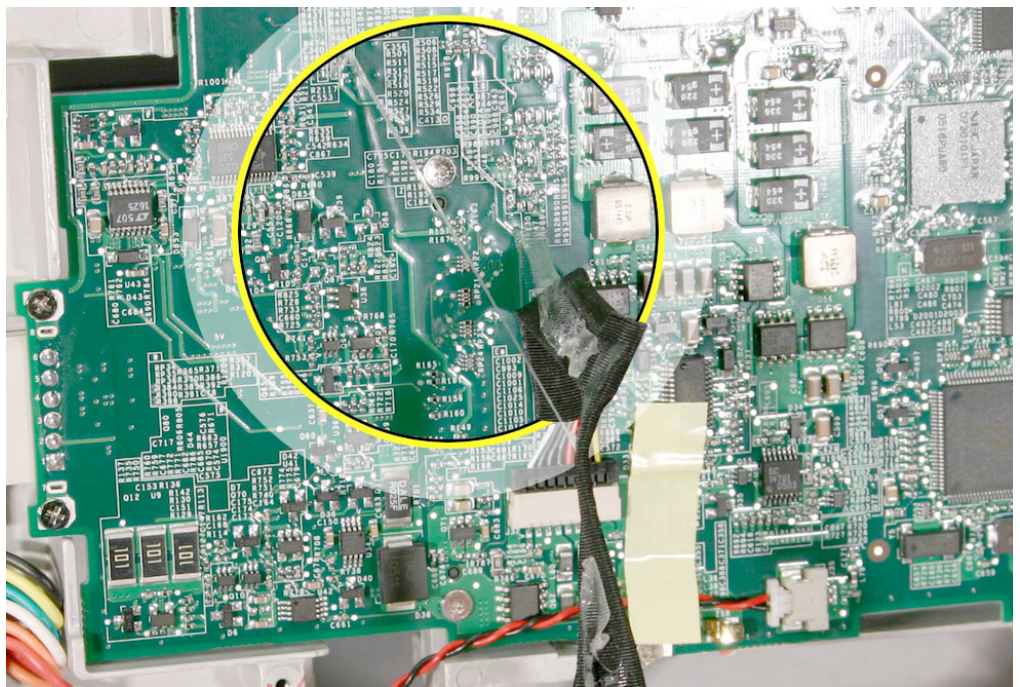
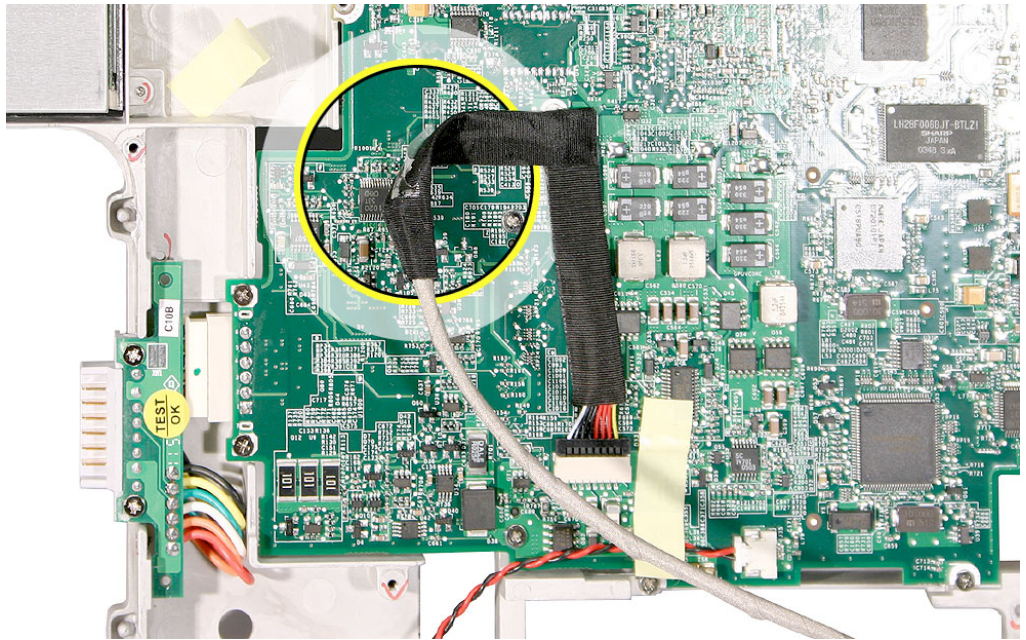

6. Disconnect the DC-in cable from the underside of the logic board.

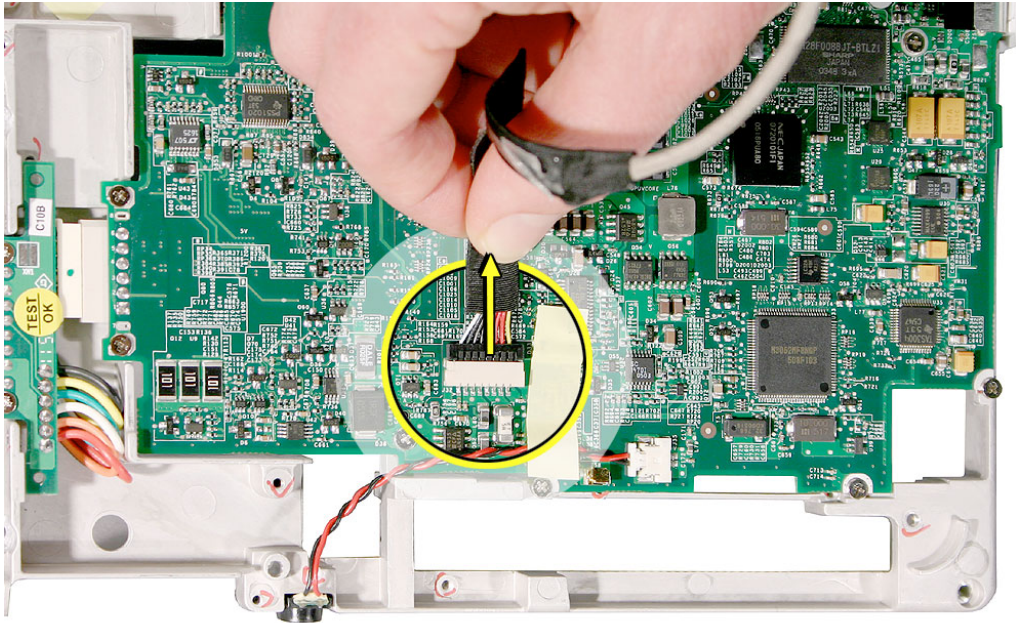

7. Remove the DC-in board from the computer assembly.
8. Install the replacement DC-in board, and reassemble and test the computer.

Important: When routing the DC-in cable, make sure you route it to the left of the frame standoff, as shown.

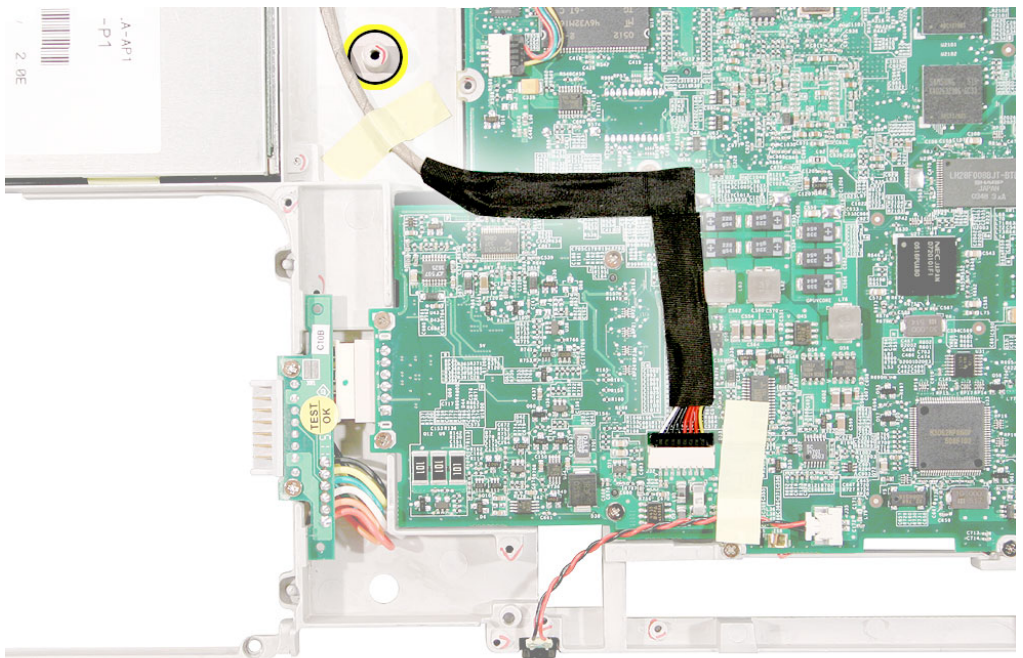



Battery Transfer Board

Tools

- Soft cloth
- #0 Phillips screwdriver
- Black stick (or other nonconductive nylon or plastic tool)

Part Location

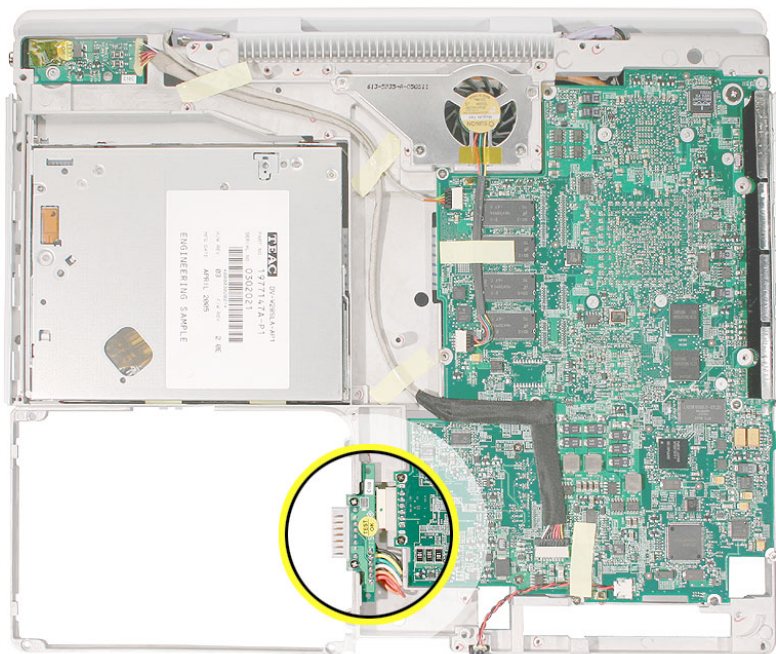

Preliminary Steps

Before you begin, remove the following:

- Battery
- Bottom case
- Bottom shield

Procedure

1. With the computer on a soft cloth, remove the two 7.5-mm long screws that secure the battery connector board to the computer frame.

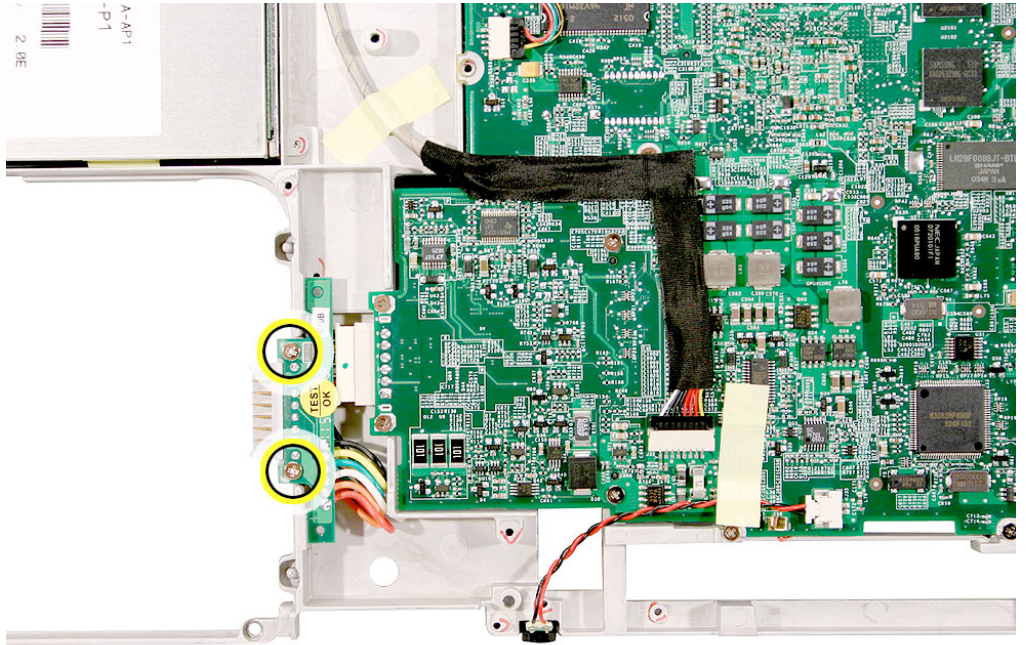

2. Disconnect the battery transfer board from the logic board.

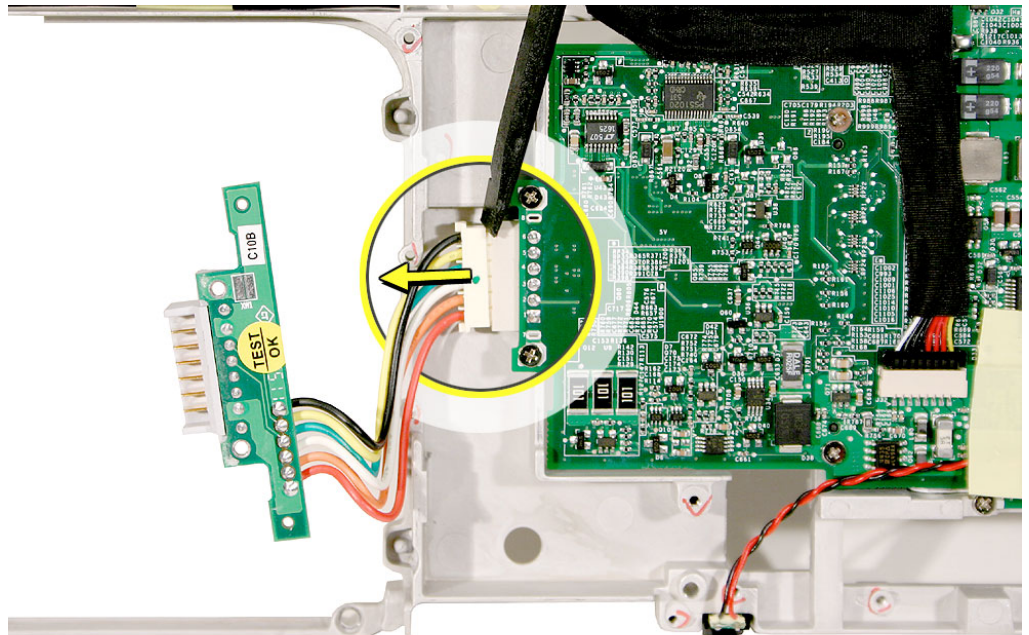

3. Install the replacement battery transfer board, and reassemble and test the computer.



Fan

Tools

- Soft cloth
- #0 Phillips screwdriver

Part Location

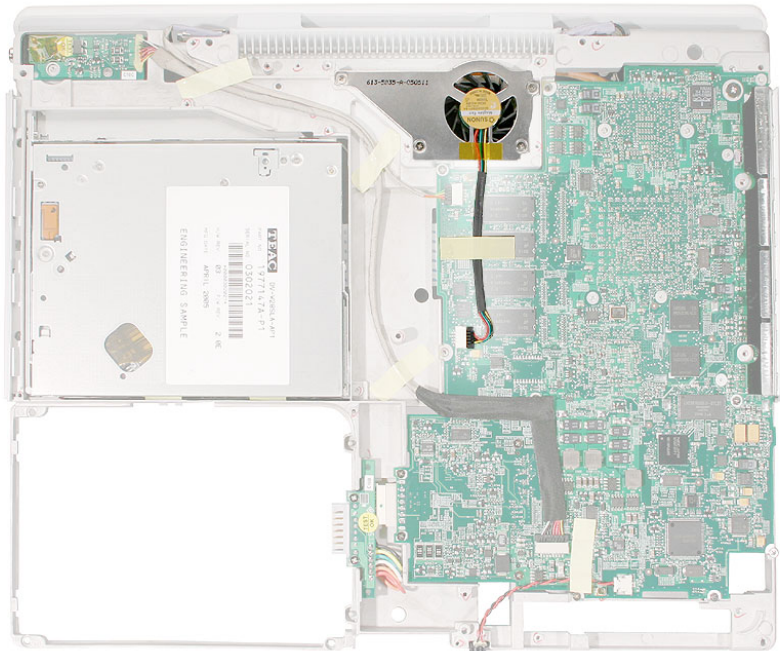

Preliminary Steps

Before you begin, remove the following:

- Battery
- Bottom case
- Bottom shield

Procedure

1. With the computer on a soft cloth, remove the four identical 3.5-mm long screws that secure the fan to the computer frame.

Replacement Note: When replacing the fan, install the four screws in a sequence that secures the opposite corners of the fan, such as: upper right (1), lower left (2), lower right (3), upper left (4).

2. Disconnect the fan cable from the logic board.
3. Peel up any tape over the fan bracket or cable.

Replacement Note: When reassembling the computer, the replacement fan might include a piece of tape that secures the cable to the body of the fan. Make sure the tape is not blocking the fan blade movement.

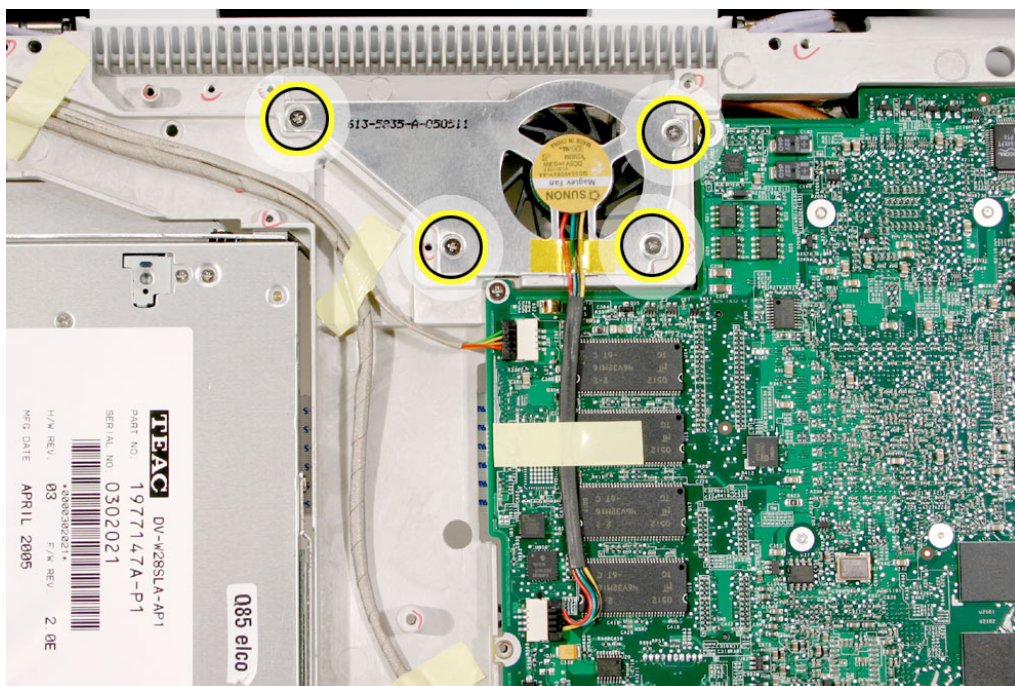

4. Lift up the fan from the computer.



5. Install the replacement fan, and reassemble and test the computer.



Top Case

Tools

This procedure requires the following tools:

- Soft cloth
- Small flat-blade screwdriver
- #0 Phillips screwdriver (magnetized recommended for optical drive screws)
- Black stick (or other nonconductive nylon or plastic tool)

Note: To organize the screws you remove from the computer, use a tray with divided compartments (such as a plastic ice cube tray).

Part Location



Preliminary Steps

Before you begin, remove the following:

- Battery
- Keyboard and RAM shield
- Memory

- Bottom case
- Bottom shield
- DC-in board

Procedure

1. With the computer on a soft cloth, remove the following screws:
 - Three 4.5-mm long screws with beveled heads at optical drive slot-load area
 - Three 3.5-mm long screws
 - Four 14.5-mm long screws
 - One 12-mm long screw

Replacement Note: When replacing the screws, install them in the order shown.

Note: Although the model pictured in this section is not identical to the subject model, the steps are the same.

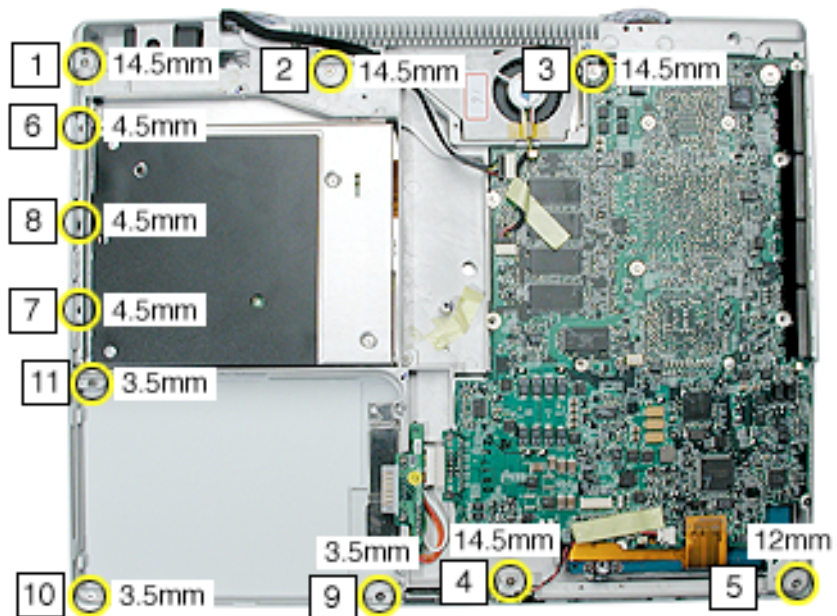

2. Turn over the computer. Using a black stick, pry up the sides of the trackpad cable connector to release the trackpad cable.
3. Remove the three screws from the keyboard well:
 - Two identical 4.5-mm long Phillips screws
 - One 3.5-mm long Phillips screw at lower left corner

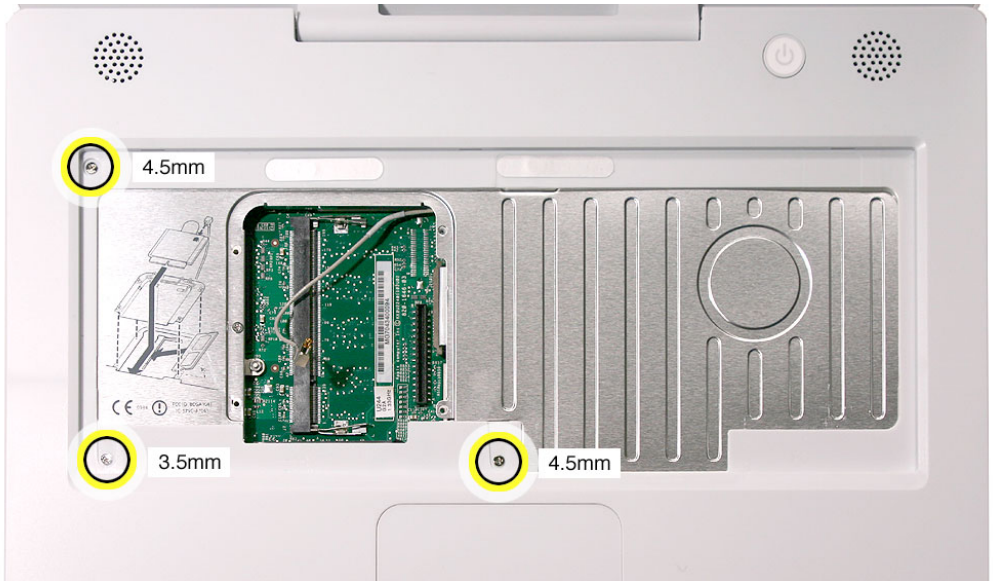

Replacement Caution: When replacing the screws in the keyboard well, make sure the shortest screw is installed in the lower left corner. Using a longer screw could damage the AirPort Extreme/Bluetooth card.



4. Use a soft cloth to protect the computer.
5. Using a black stick, begin to carefully separate the top case from the computer assembly. Reposition the computer as you work around the top case to open up the seam that joins the top case and bottom case.
6. While continuing to loosen the top case, use caution around the battery bay. If necessary, flex the inner frame to release that corner of the top case.

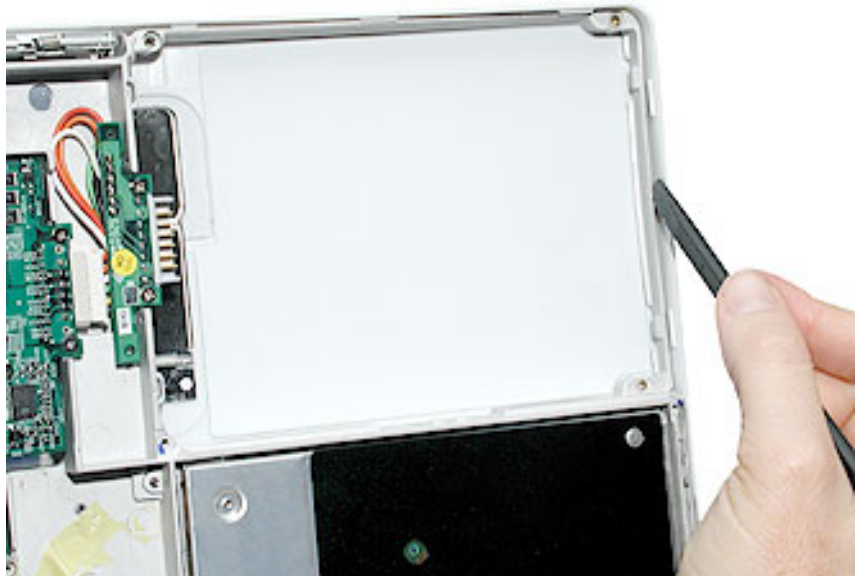

7. **Warning: The top case is connected to the computer assembly with delicate cables. Do not remove the top case until the cables are disconnected (see the next steps).**

With most of the top case loosened, place the top case off center so you can access the trackpad cable. Use a black stick to disconnect the trackpad cable.

Warning: When performing this step, make sure the speaker cable and shorter power switch cable are not strained.

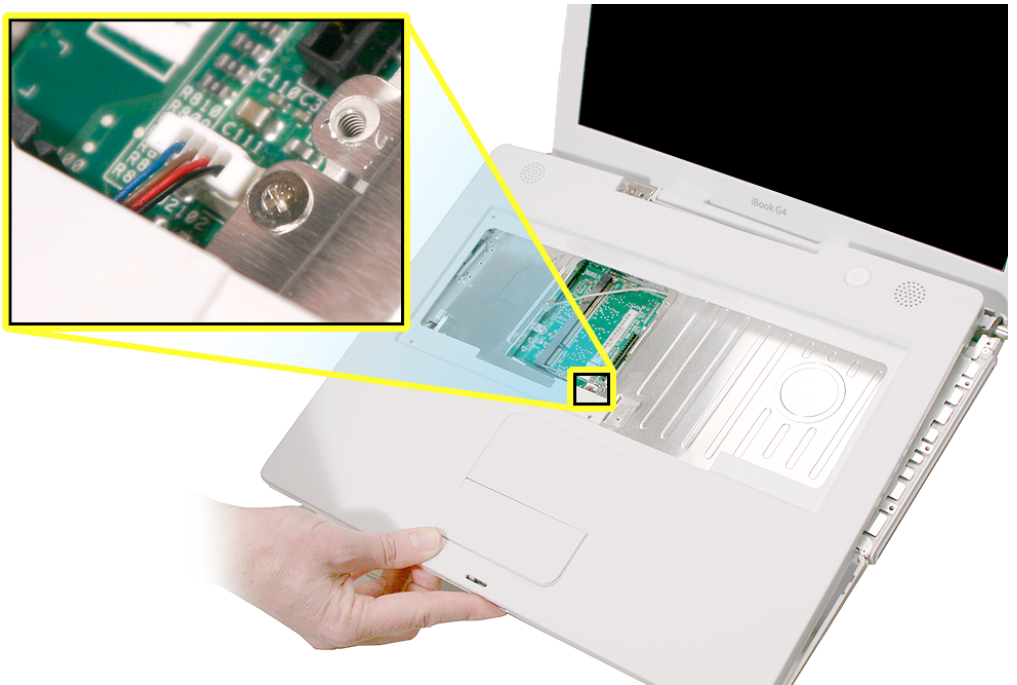

8. With the speaker cable and power cable still attached, carefully reposition the top case so you can access the two remaining cables.
9. Use a black stick to carefully disconnect the cables from the logic board.
10. Remove the top case from the computer.

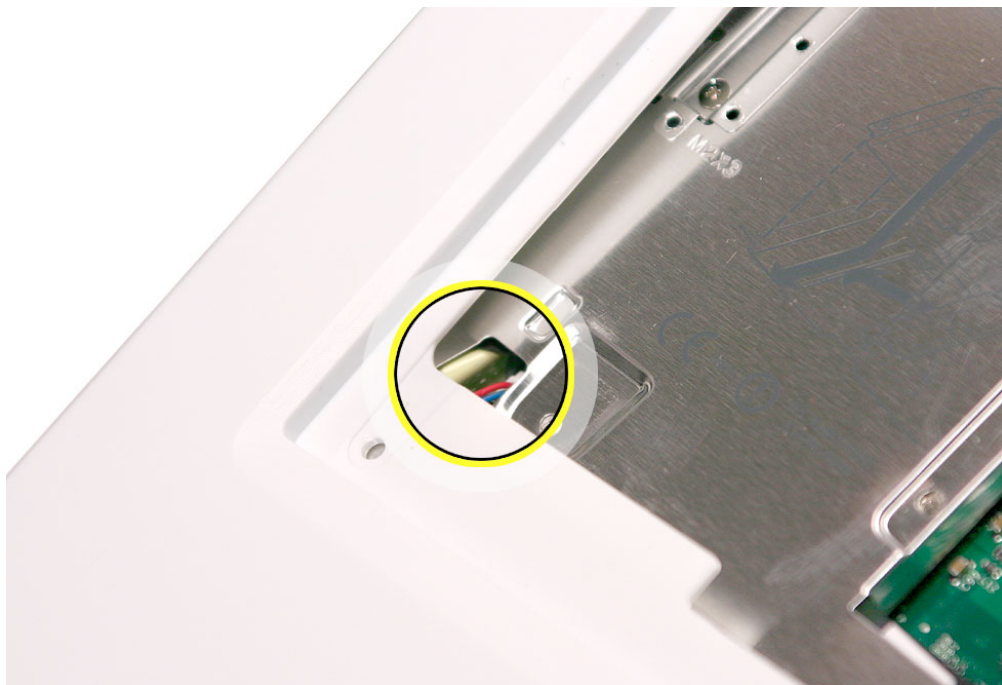
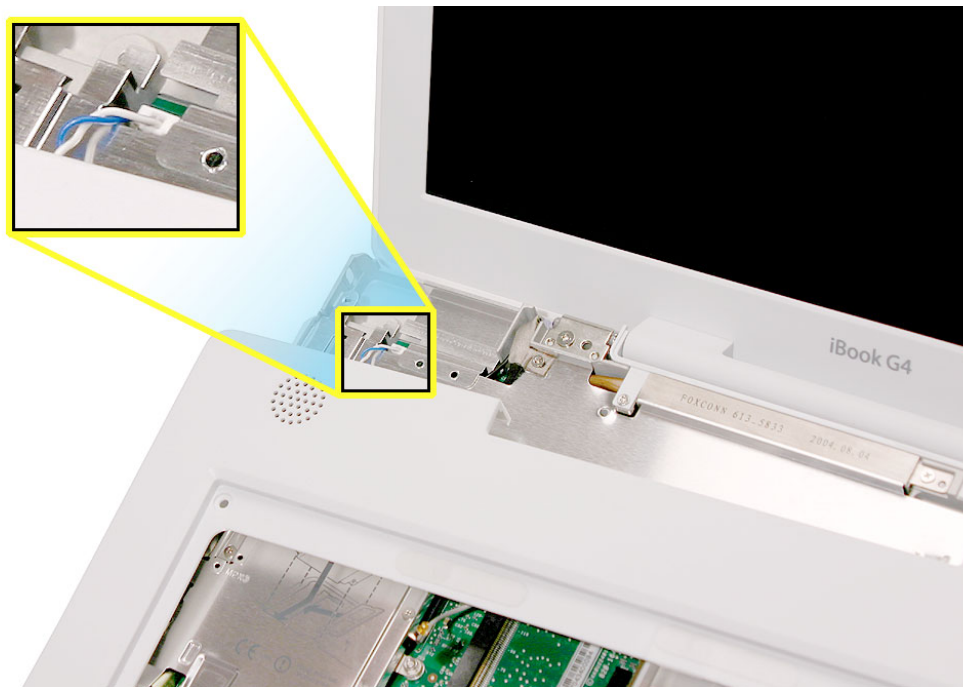

11. Before installing the replacement top case, make sure it includes the following:
 - Speaker set
 - Power button and board (under left speaker)
 - Speaker cable and power switch cable
 - Trackpad assembly with board and cable
 - Display latch
12. **Important:** Make sure you transfer the original serial number label and Ethernet label from the old top case to the replacement top case. You can use a black stick to carefully peel up a corner of the label. Then peel off the label completely and apply it to the replacement top case. Make sure that the labels lie completely flat so they do not interfere with the battery compartment.

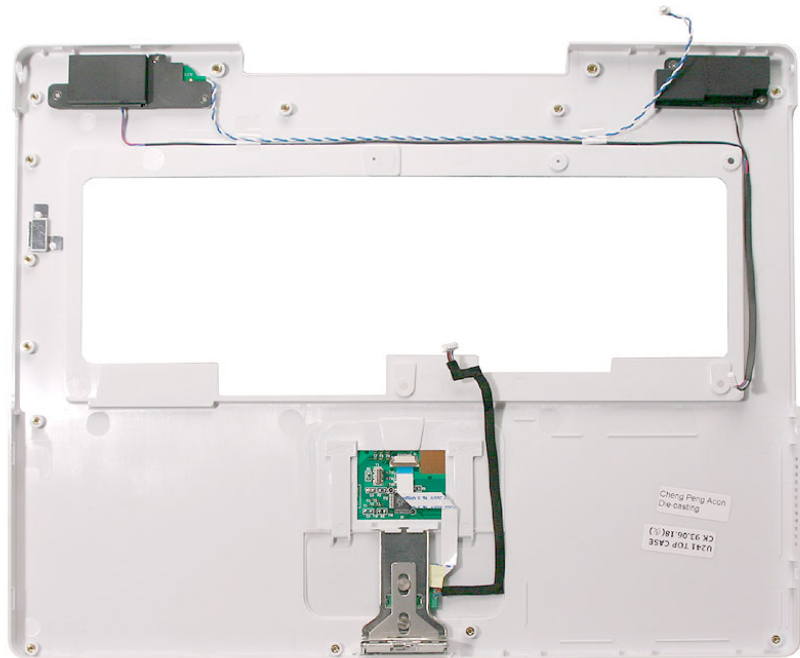

-
13. Install the replacement top case, and reassemble and test the computer.

Note: When installing the replacement top case, connect the power switch cable connector (the shorter cable) first. Then connect the speaker cable connector. Do not strain the cables.

Warning: When reassembling the computer, be careful not to pinch any cables as you press the top case back onto the computer. Check that the top case shows no raised surfaces and is fully snapped into place before installing the remaining screws.



Sleep Light Board

Tools

- Soft cloth
- #0 Phillips screwdriver
- Black stick (or other nonconductive nylon or plastic tool)

Part Location

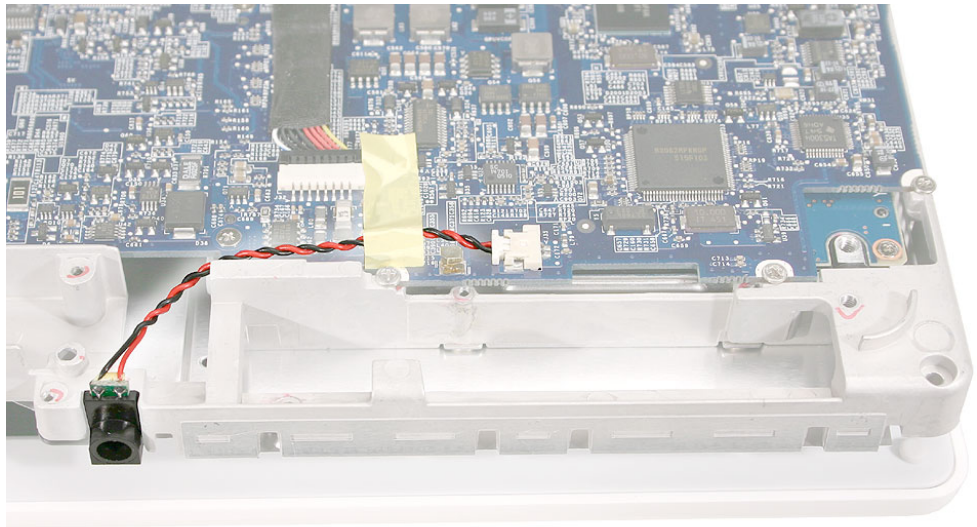

Preliminary Steps

Before you begin, remove the following:

- Battery
- Keyboard and RAM shield
- Memory card
- Bottom case
- Bottom shield
- DC-in board
- Top case

Procedure

1. With the computer on a soft cloth, note the location of the sleep light board connector on the logic board.

Note: When reassembling the computer, make sure the sleep light board is positioned as shown and does not get caught between the top and bottom case.

2. Peel up any tape that may hold the cable in place.
3. Disconnect the cable that attaches the sleep light board to the logic board.

Caution: Be careful not to bend the spring clip next to the connector.

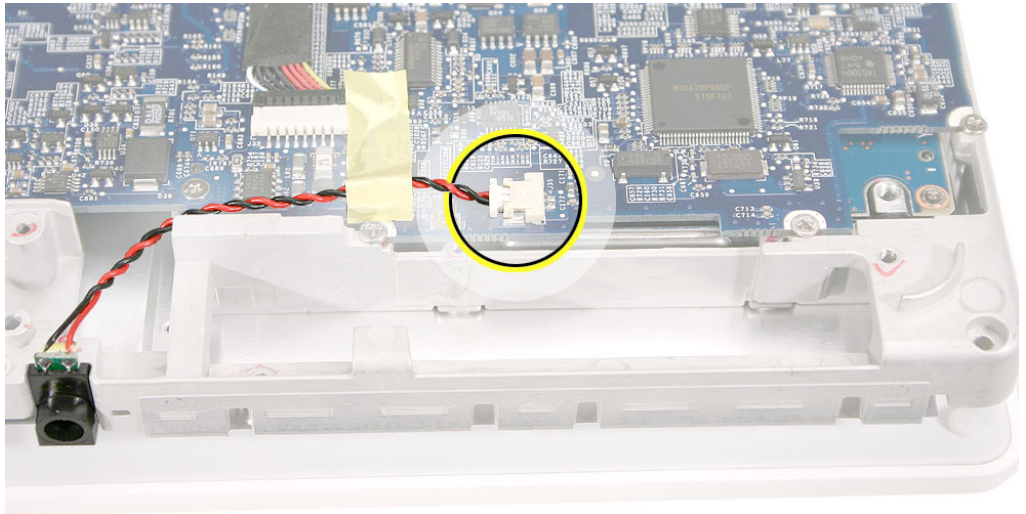

4. Turn over the computer and remove the 4.5-mm long screw from the sleep light holder and frame.

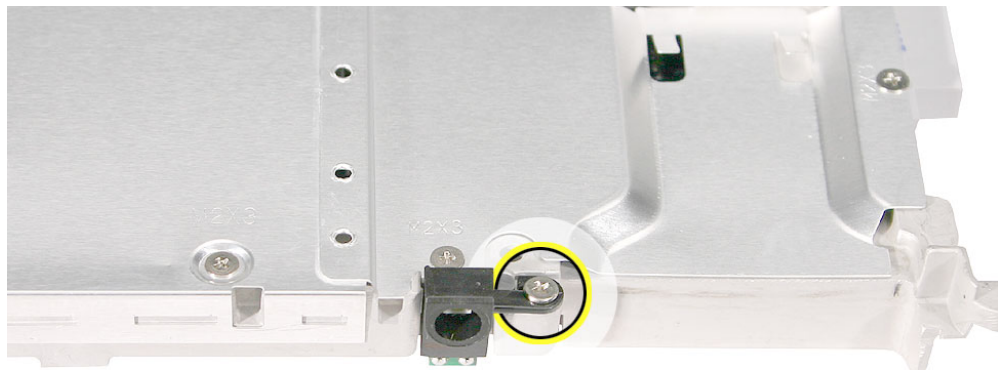

5. Remove the sleep light board and holder from the frame.

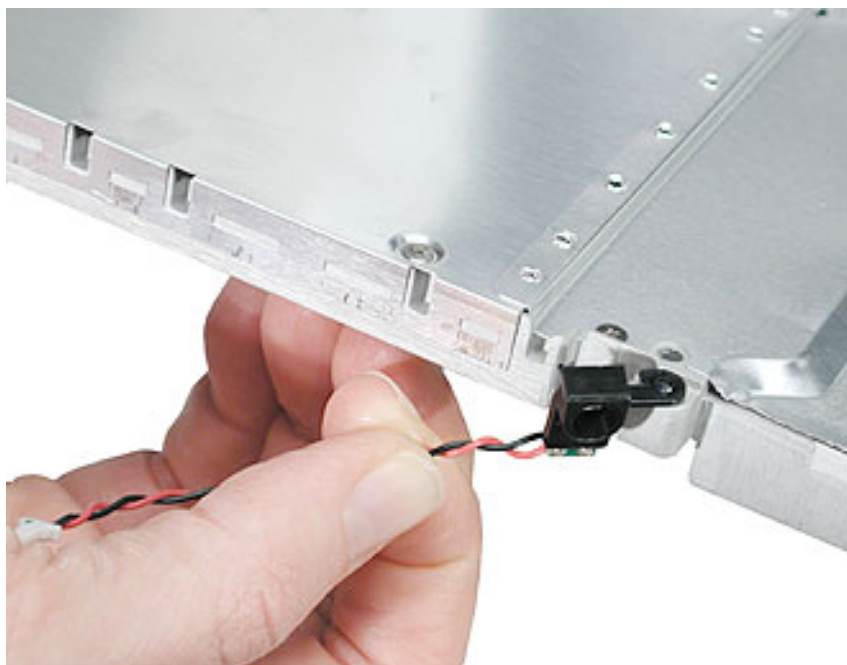

6. Install the replacement sleep light board, and reassemble and test the computer.



Display Latch

Tools

This procedure requires the following tools:

- Soft cloth
- Black stick (or other nonconductive nylon or plastic tool)

Part Location

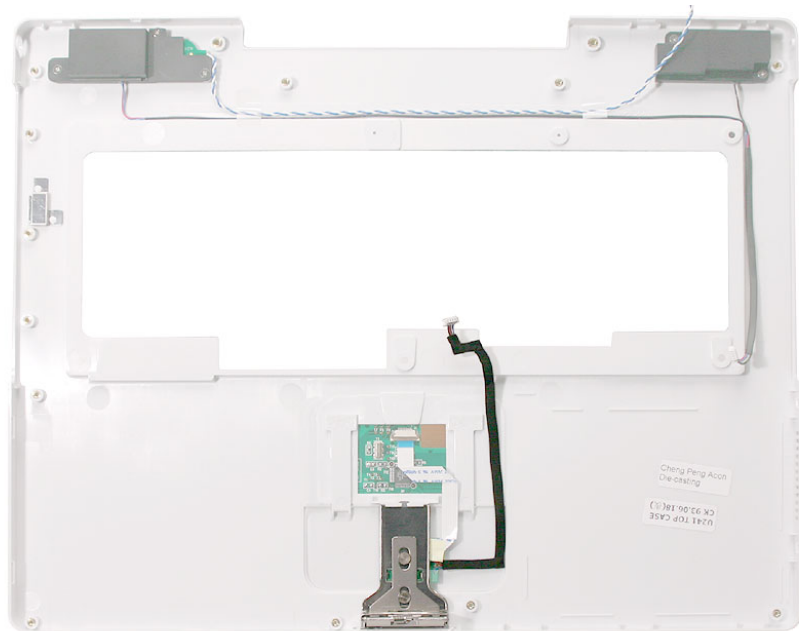

Preliminary Steps

Before you begin, remove the following:

- Battery
- Keyboard and RAM shield
- Memory card
- Bottom case
- Bottom shield

- DC-in board
- Top case

Procedure

1. With the top case on a soft cloth, note the routing of the trackpad flex cable to the trackpad board.

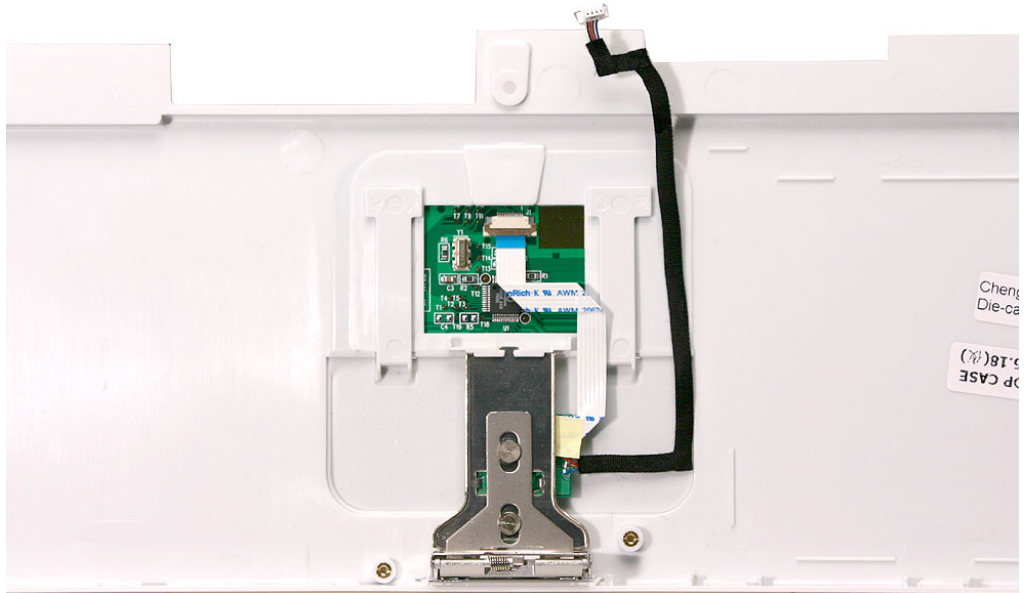

2. Using your fingernail or a black stick, tilt up the brown hinged locking connector.

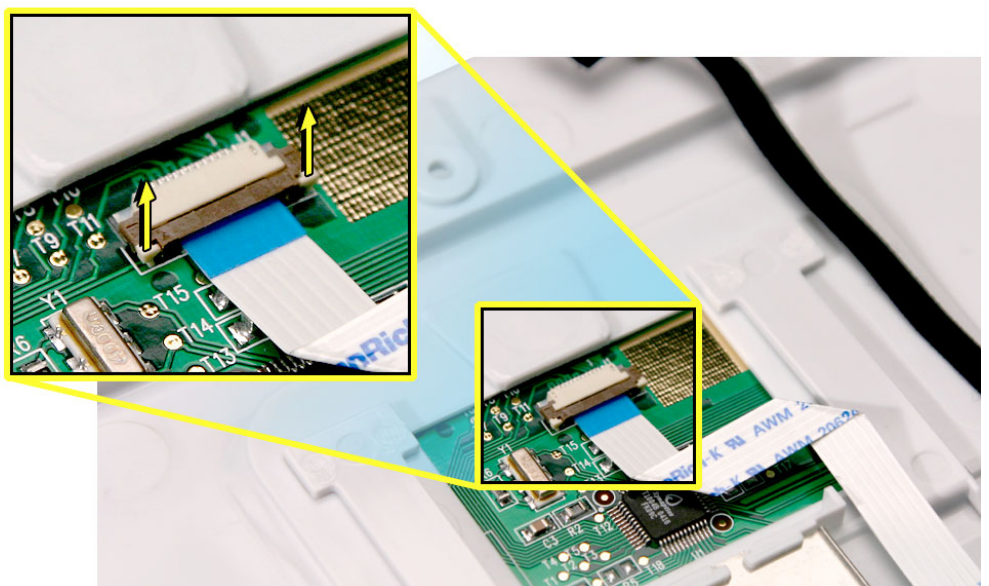

3. With the locking connector tilted up, slide out the trackpad cable.

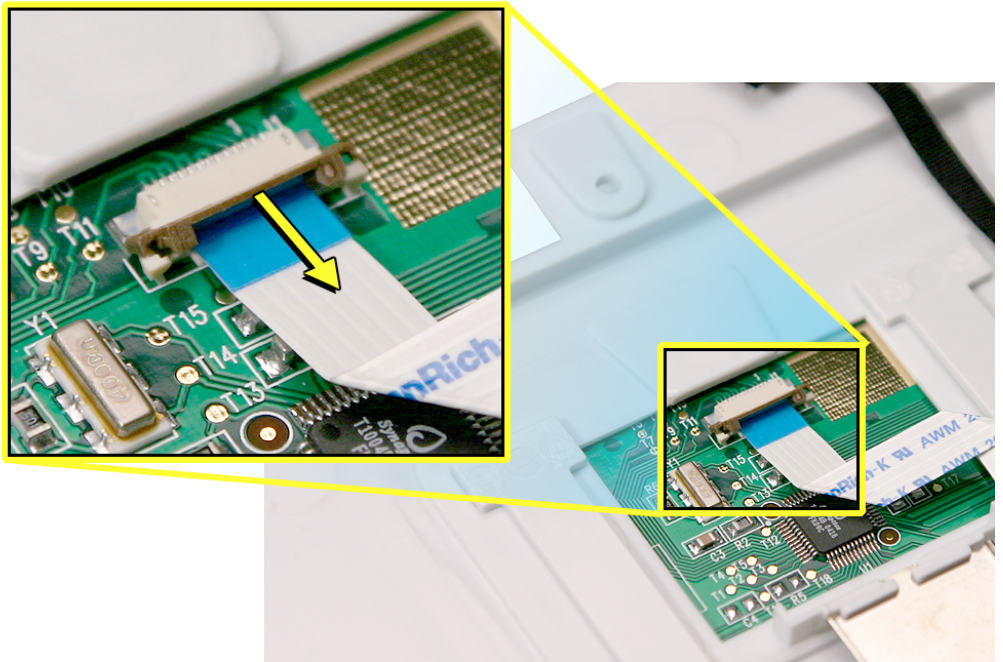

4. Holding the top case steady, press the latch button in and under the lip of the top case. You might need to flex the latch opening somewhat to remove it from the top case.

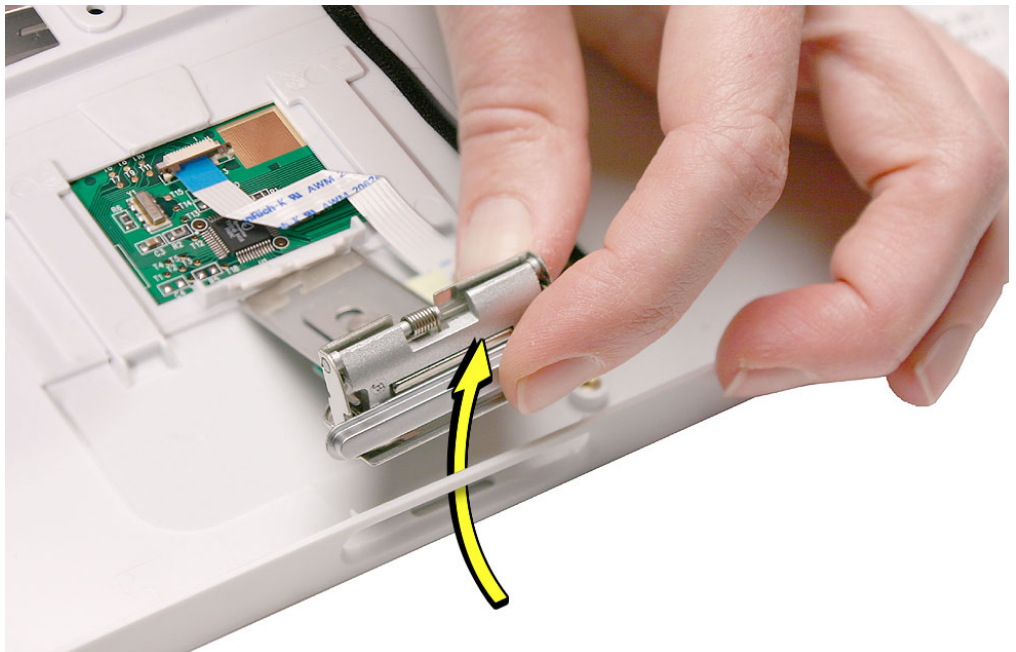

5. Carefully peel up the trackpad cable from the top case.

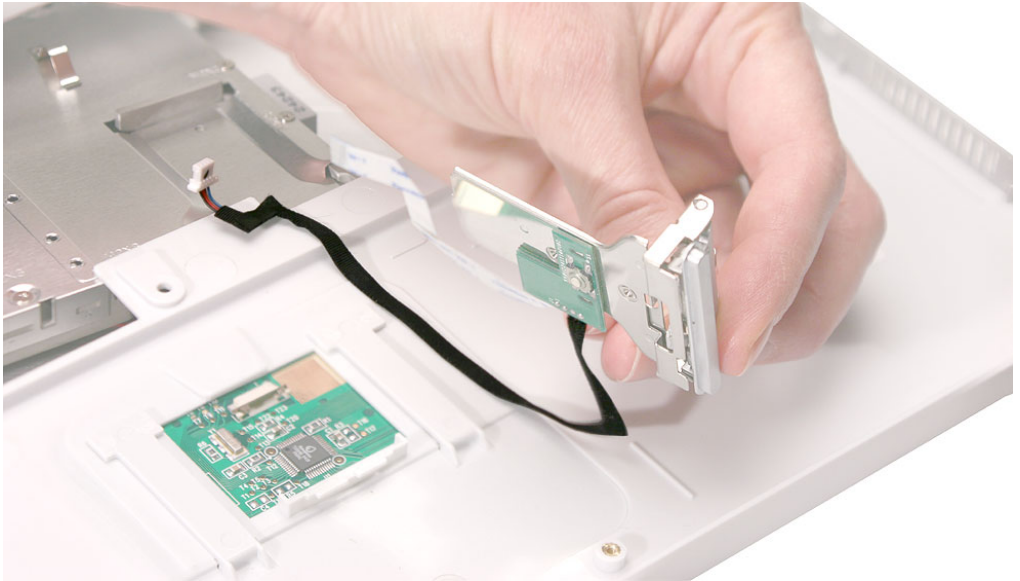

6. Install the replacement display latch by tilting it onto the trackpad assembly, pressing the latch button, and feeding the latch into the latch opening in the top case. Test that the latch button works easily.
7. Reassemble and test the computer.

Warning: When reassembling the computer, be careful not to pinch any cables as you press the top case back onto the computer. Check that the top case shows no raised surfaces and is fully snapped into place before installing the remaining screws.

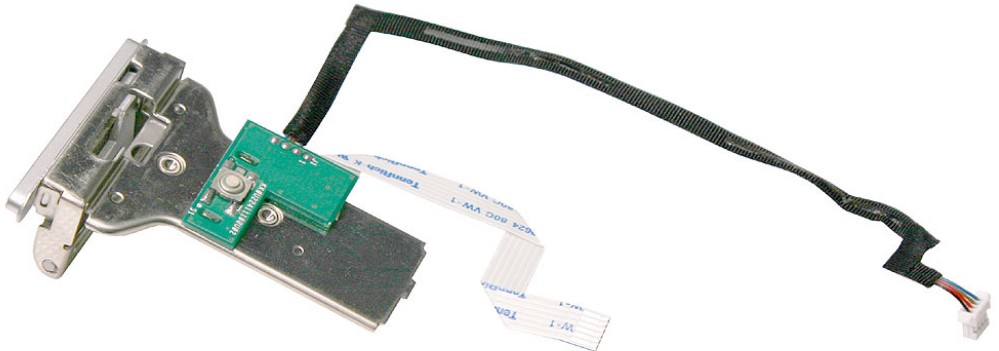



Top Shield

Tools

- Soft cloth
- #0 Phillips screwdriver
- #1 Phillips screwdriver
- Black stick (or other nonconductive nylon or plastic tool)

Note: To organize the screws you remove from the computer, use a tray with divided compartments (such as a plastic ice cube tray).

Part Location

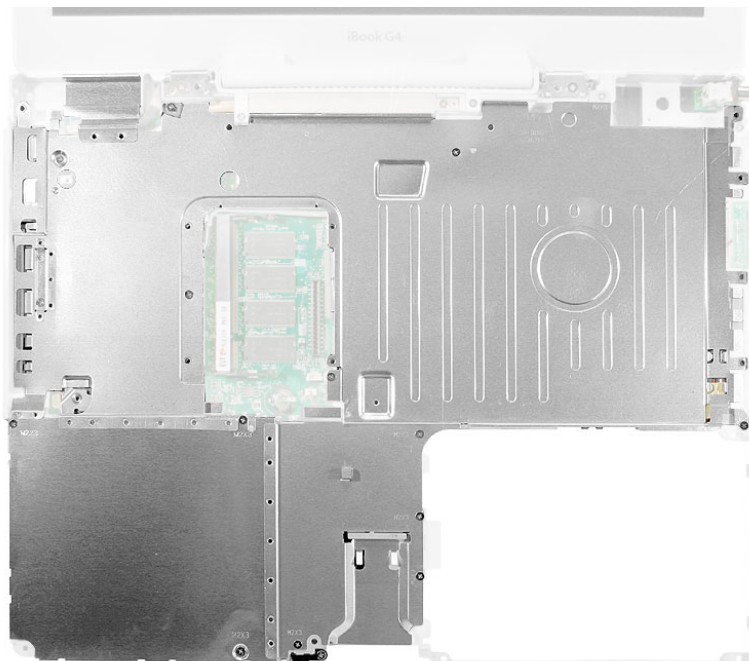

Preliminary Steps

Before you begin, remove the following:

- Battery
- Keyboard and RAM shield

- Memory card
- Bottom case
- Bottom shield
- DC-in board
- Top case

Procedure

1. With the computer on a soft cloth, remove the following Phillips screws:
 - Two 4.5-mm long screw
 - Fourteen 3-mm long screws

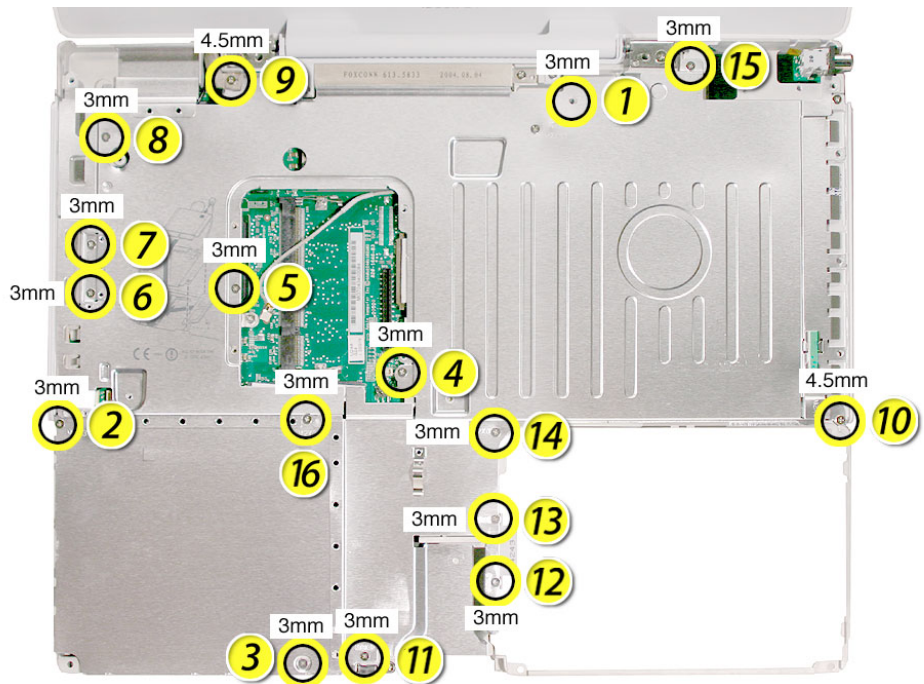

Replacement Note: The longest screw at the top shield secures the LVDS cable to the shield and frame.

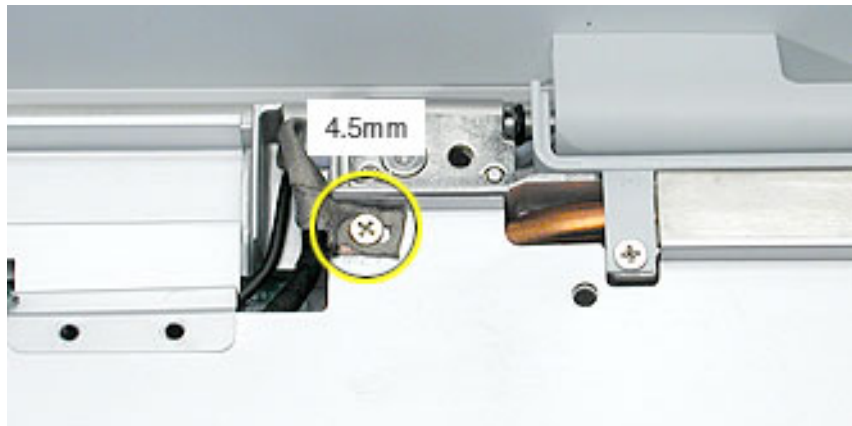

2. Using a black stick, carefully peel up, but do not remove, any pieces of tape.

Note: When reassembling the computer, reuse the tape to secure the replacement top shield.

Replacement Note: When reinstalling the top shield, make sure the AirPort antenna cable at the display hinge is routed neatly underneath the shield.

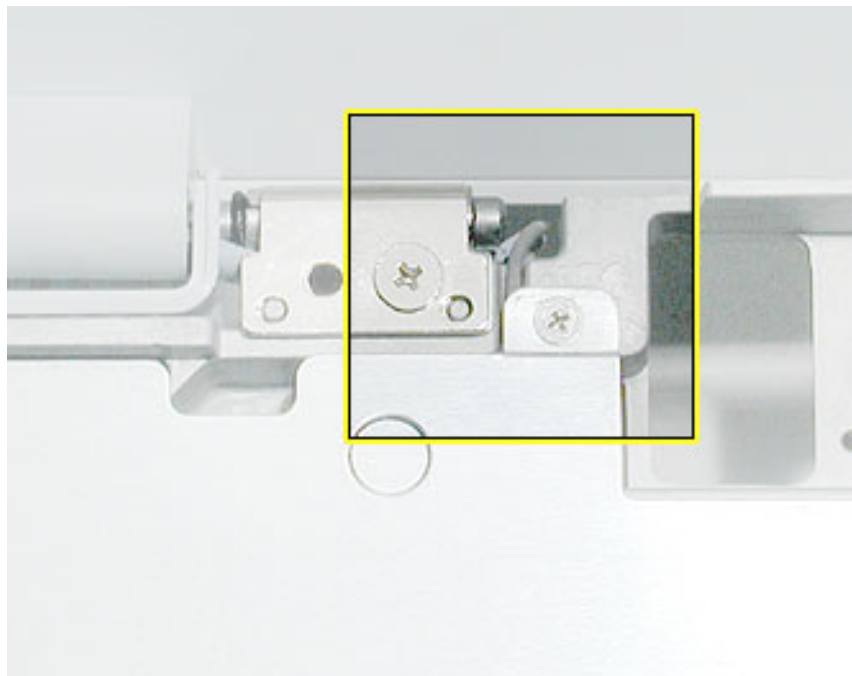

3. **Warning: Do not bend the top shield.**

Lift the top shield off the computer, being careful where it might catch on the computer assembly.



4. Install the replacement top shield, and reassemble and test the computer.

Replacement Note: Before securing the top shield, check that the long mesh strip is attached to the replacement top shield, as shown.

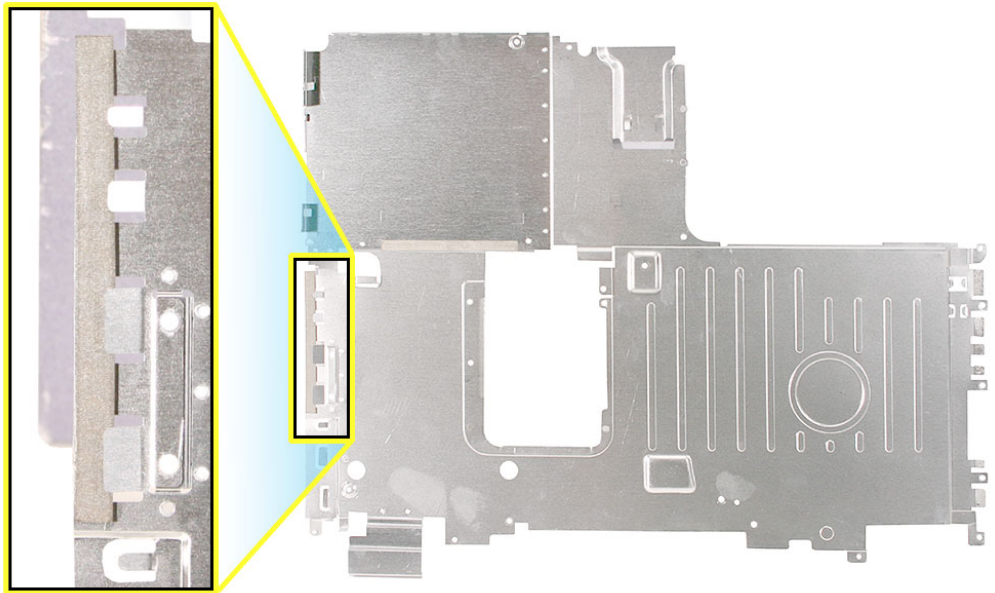

Replacement Note: Compare the computer assembly to the image shown below. Make sure the cables are connected, and routed as shown.

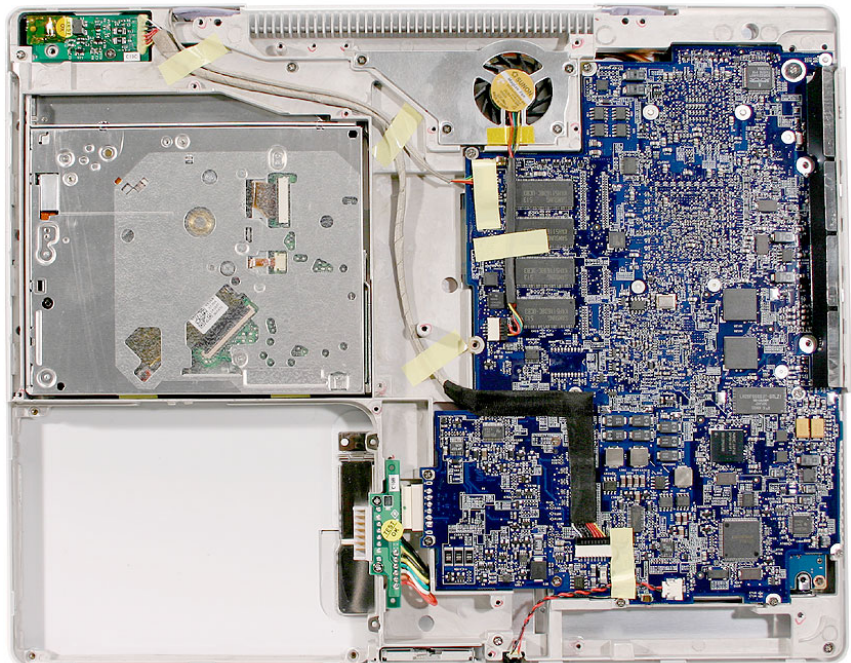
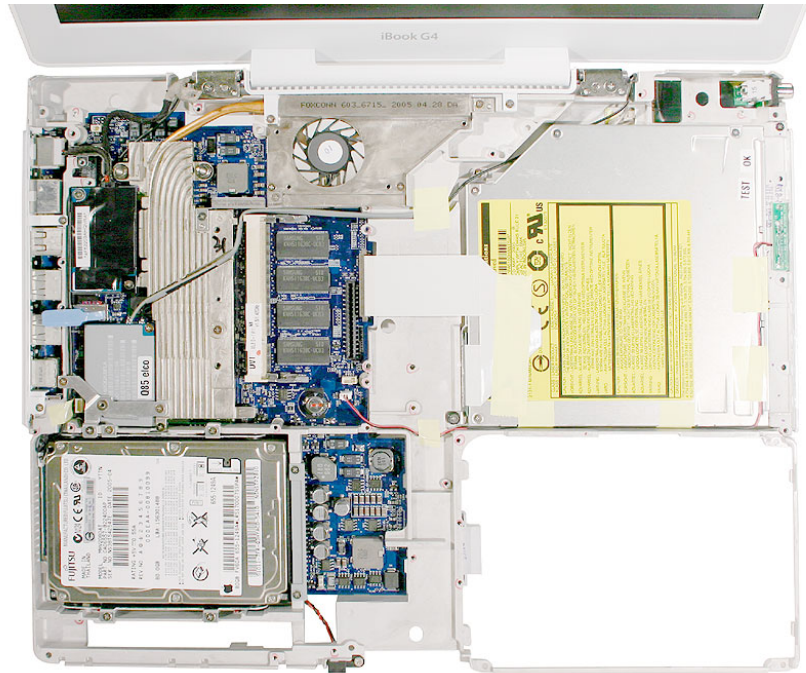



I/O Bezel

Tools

- Soft cloth
- #0 Phillips screwdriver
- Black stick (or other nonconductive nylon or plastic tool)

Part Location

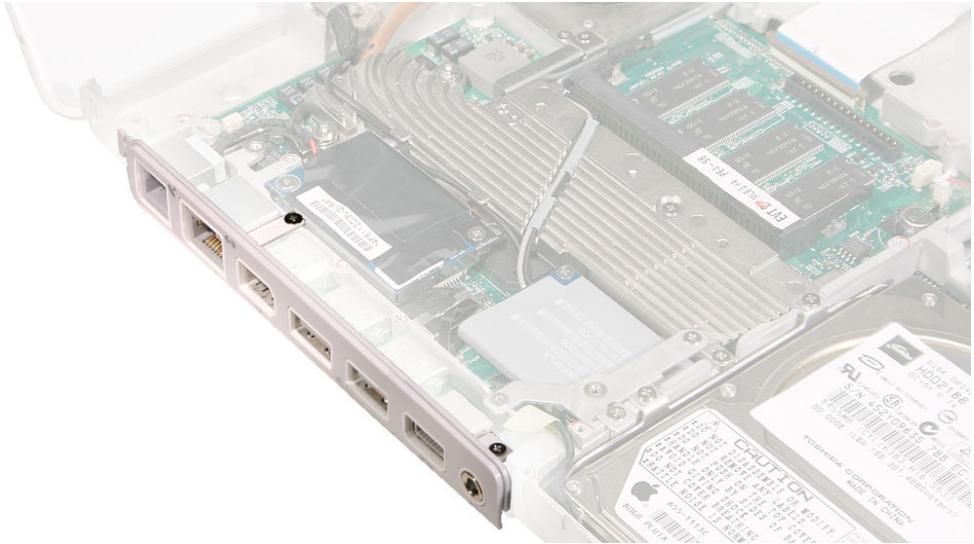

Preliminary Steps

Before you begin, remove the following:

- Battery
- Keyboard and RAM shield
- Memory card
- Bottom case
- Bottom shield
- DC-in board
- Top case
- Top shield

Procedure

1. With the computer on a soft cloth, remove the two screws from the I/O bezel:
 - 3-mm long screw at longer tab
 - 2-mm long screw at shorter tab

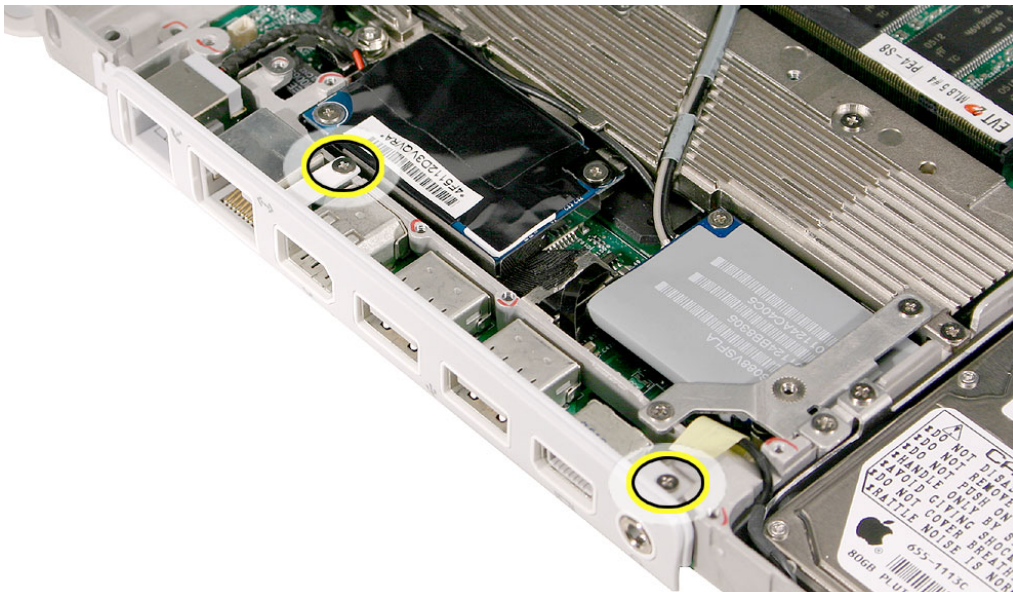

2. Remove the I/O bezel from the computer frame.

Note: When reassembling the computer, make sure that the I/O bezel is level and fits over all ports.

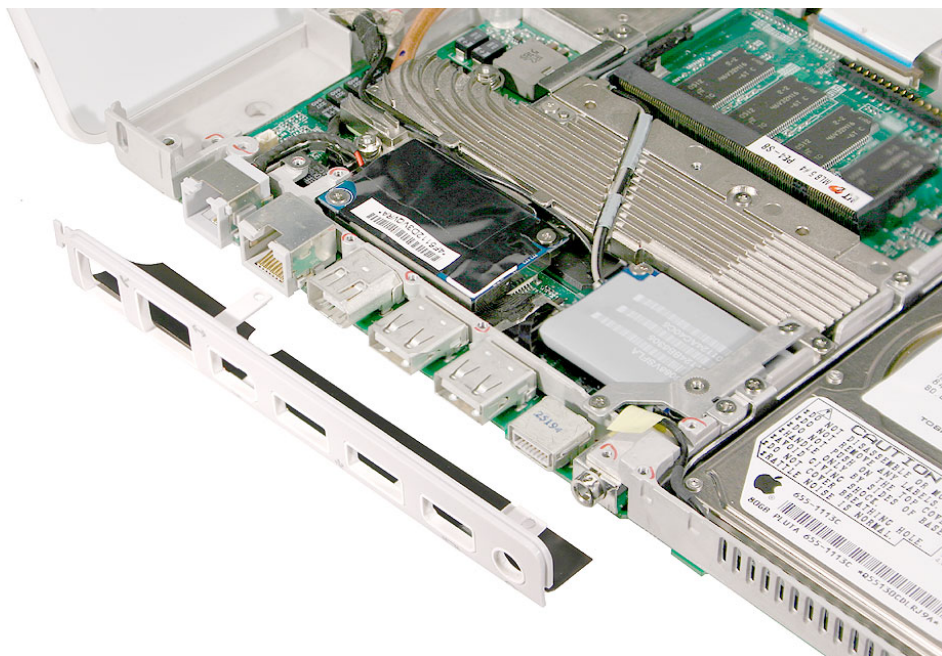

3. Install the replacement I/O bezel, and reassemble and test the computer.

Note: When installing the replacement I/O bezel, make sure the bezel shield and the mylar panel fits over the underside of the logic board, as shown below.

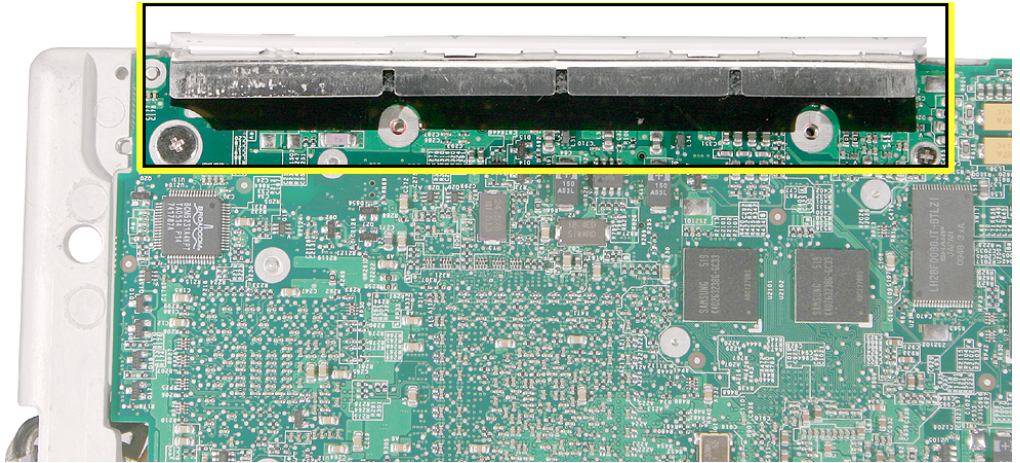



RJ11 Modem Cable

Tools

- Soft cloth
- Black stick (or other nonconductive nylon or plastic tool)

Part Location

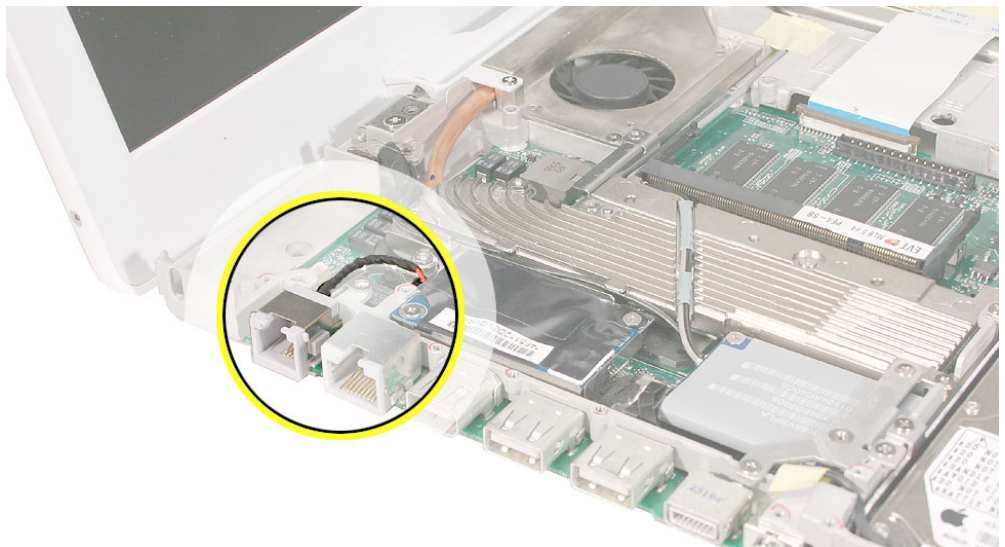

Preliminary Steps

Before you begin, remove the following:

- Battery
- Keyboard and RAM shield
- Memory card
- Bottom case
- Bottom shield
- DC-in board
- Top case
- Top shield
- I/O bezel

Procedure

1. With the computer on a soft cloth, lift up the modem sleeve and disconnect the RJ11 modem cable from the modem board.

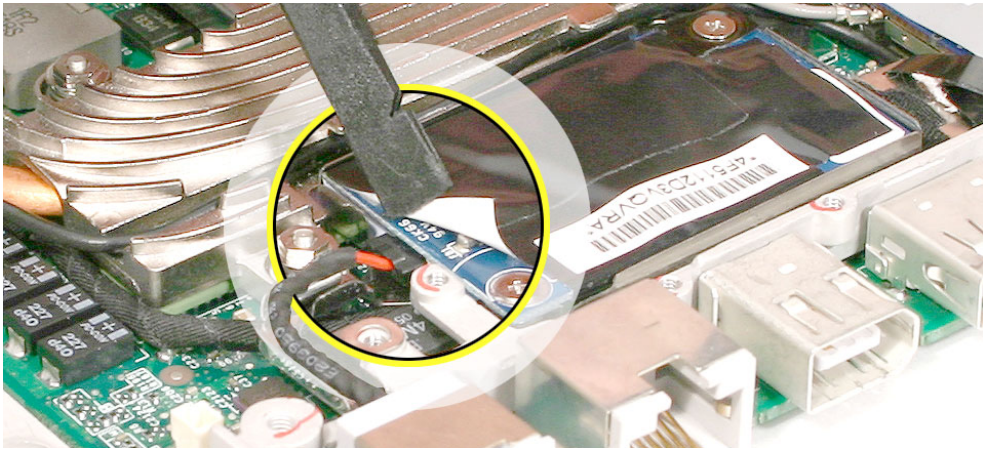

2. Guide the cable up through the metal channel.
3. While supporting the computer assembly, slide the modem port forward and off of the logic board.

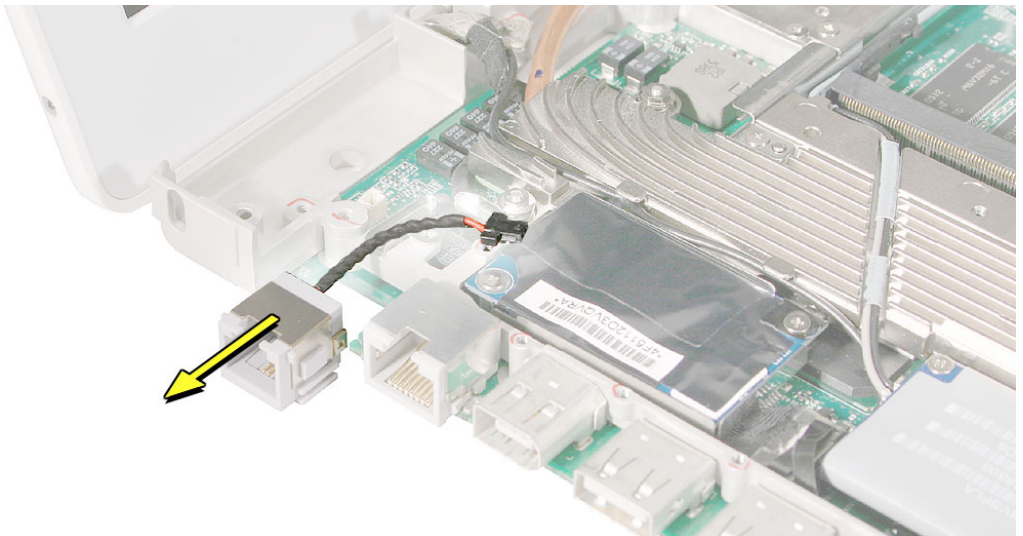

4. Install the replacement RJ11 modem cable, and reassemble and test the computer.



Hard Drive

Tools

- Soft cloth
- #0 Phillips screwdriver
- Black stick (or other nonconductive nylon or plastic tool)
- Torx T8 screwdriver

Note: To organize the screws you remove from the computer, use a tray with divided compartments (such as a plastic ice cube tray).

Part Location

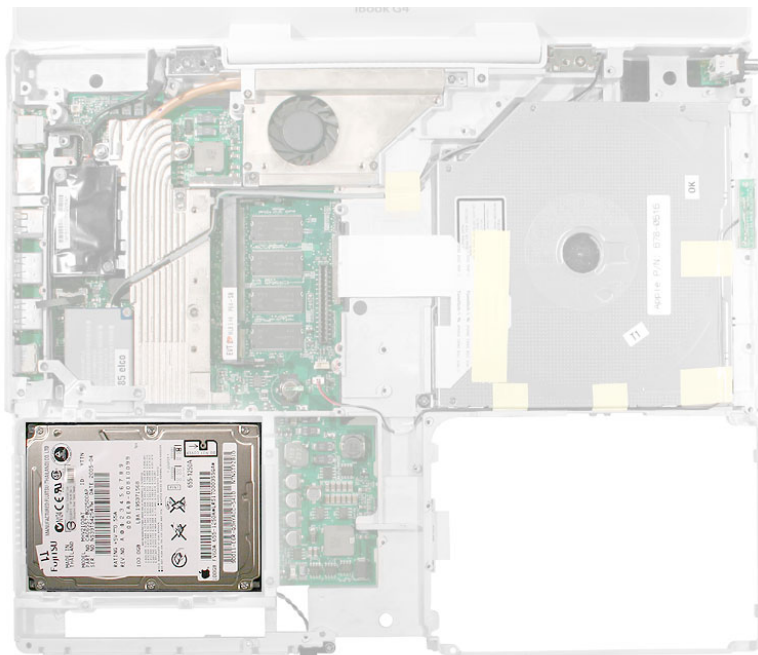

Preliminary Steps

Before you begin, remove the following:

- Battery
- Keyboard and RAM shield

- Memory card
- Bottom case
- Bottom shield
- DC-in board
- Top case
- Top shield

Procedure

1. Remove the six identical 4.5-mm long screws:
 - four from the hard drive brackets
 - two from the holder over the hard drive connector

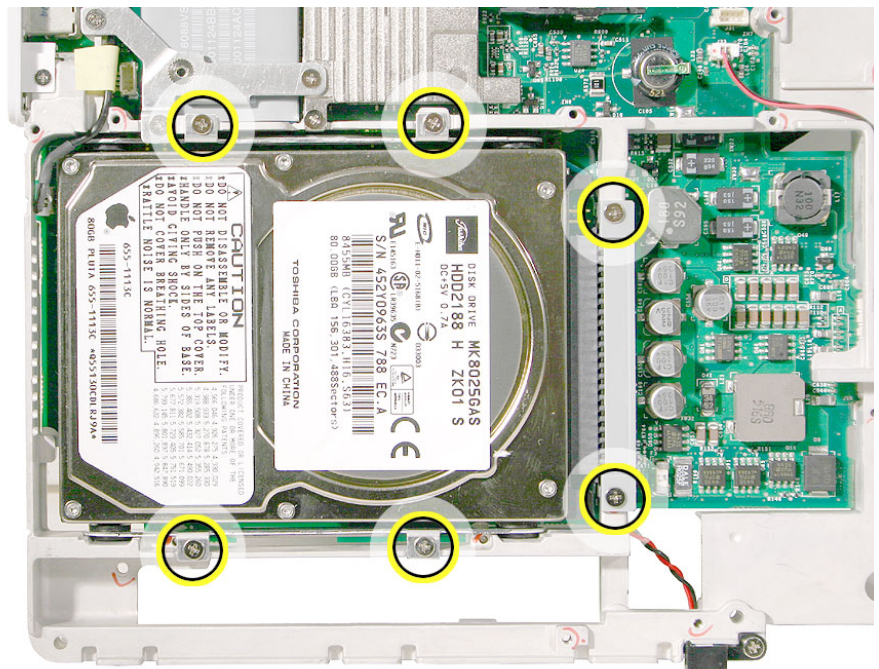

- Lift off the holder from the hard drive connector.

Replacement Note: Be sure to reinstall the connector holder when replacing the hard drive.

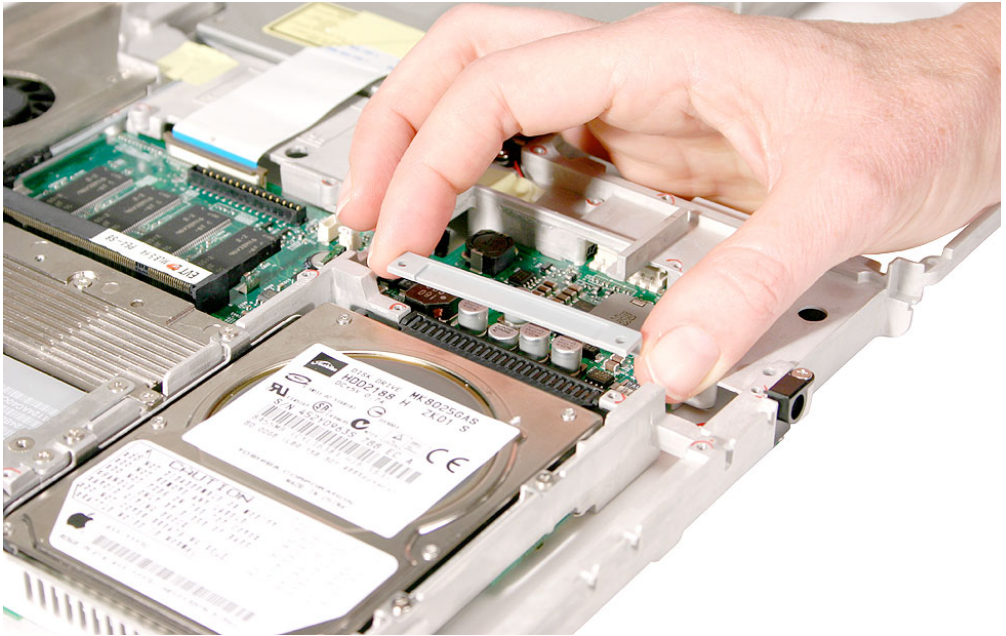

- Check the position of the microphone cable at the upper left corner of the drive.

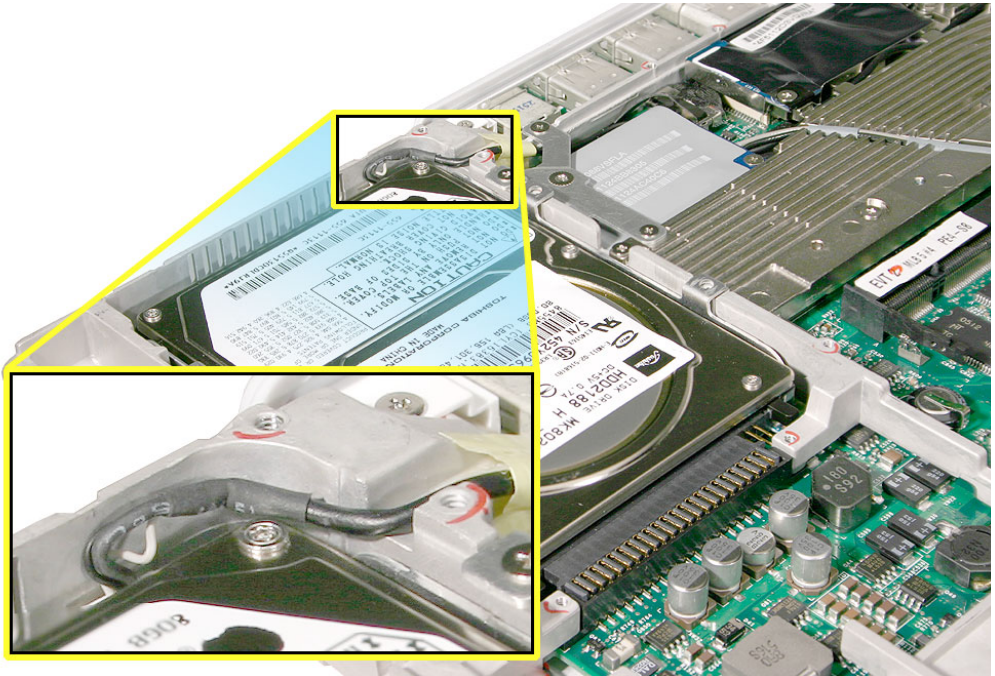

4. If the microphone cable is blocking the corner of the drive, use a black stick to carefully move it aside.

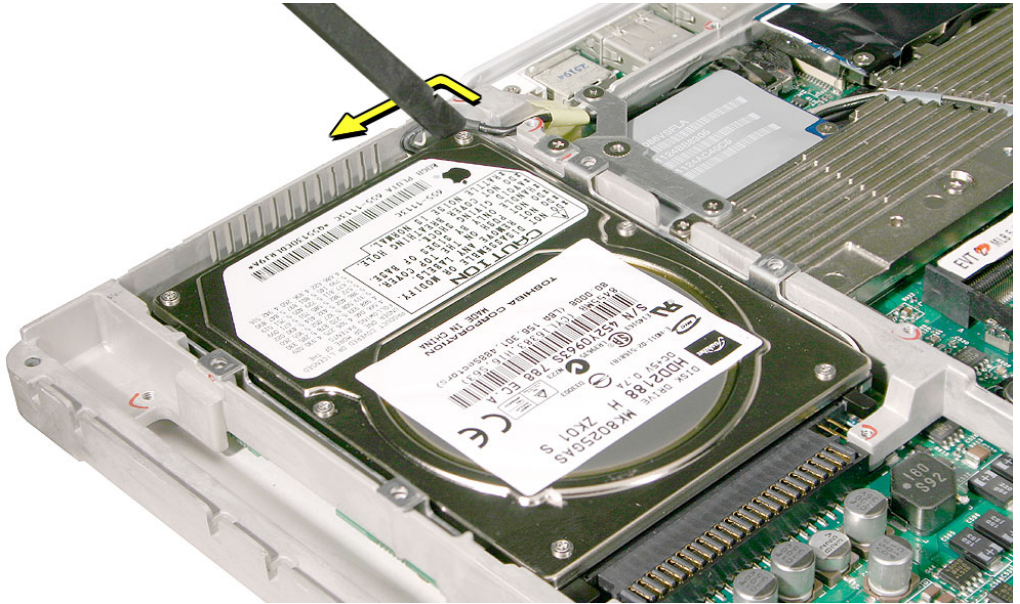

5. Press in on the upper bracket to clear it from the frame. While pressing on the bracket, use a black stick to begin to lift up the end of the hard drive.

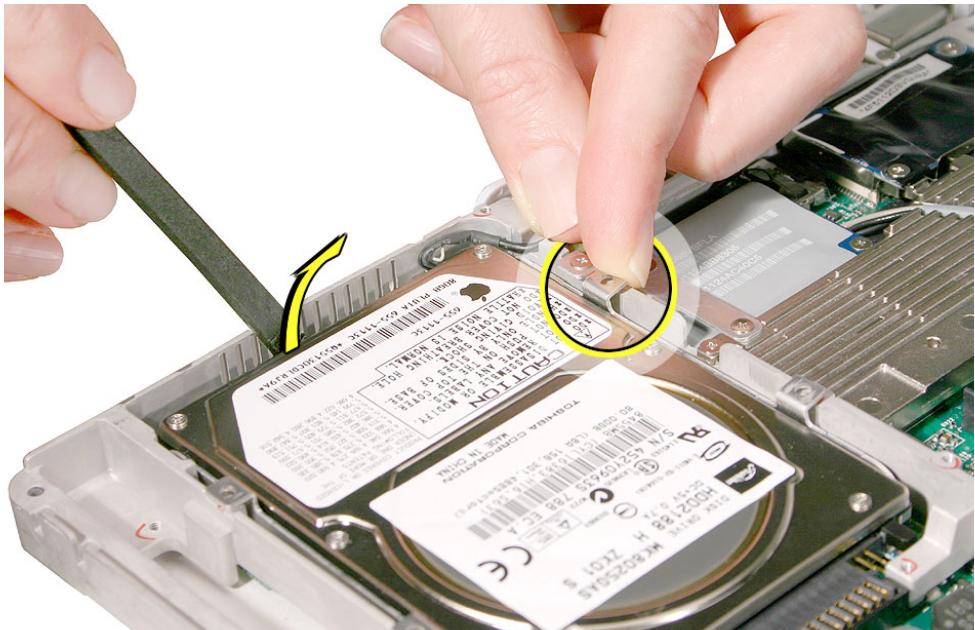

6. Lift up the end of the drive until you can grasp its sides.

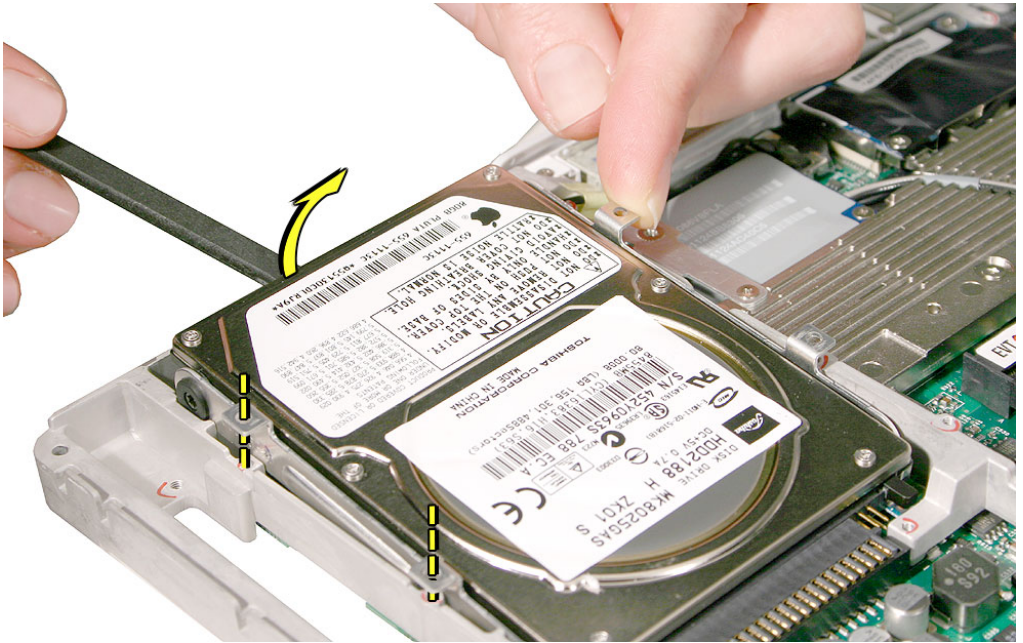

7. **Warning: Handle the hard drive at the sides only. Do not touch or press anywhere else on the drive.**

Lift up the drive just slightly to loosen the hard drive connector.

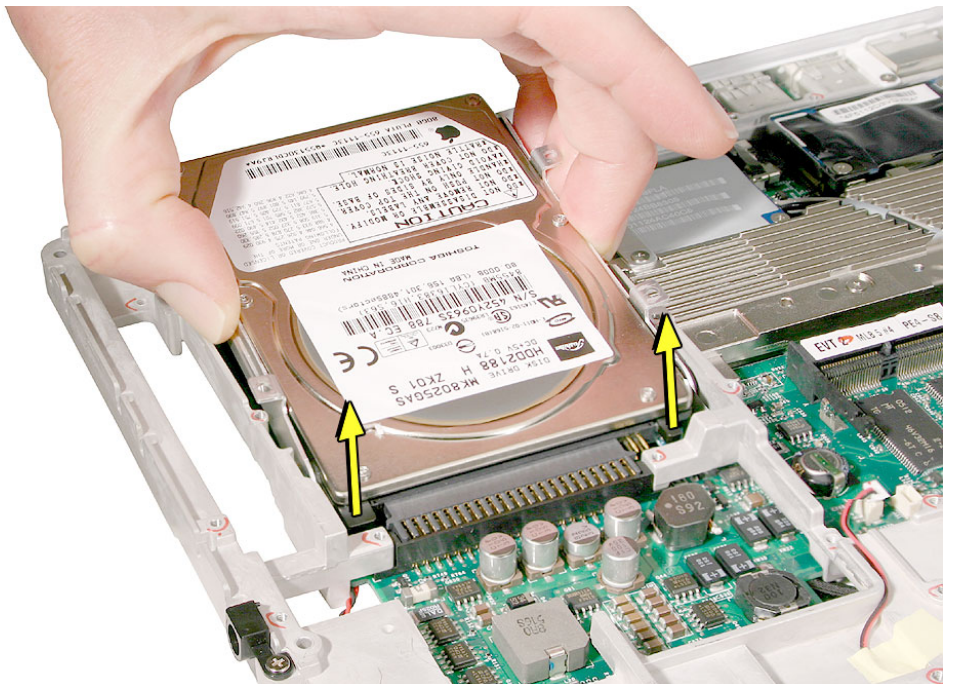

- From the end of the drive that is closest to the corner of the frame, tilt up the hard drive, and loosen it from the connector on the logic board. Use a black stick to pry up the drive.

Important: Keep the drive as level as possible as you lift it straight up out of the computer assembly.

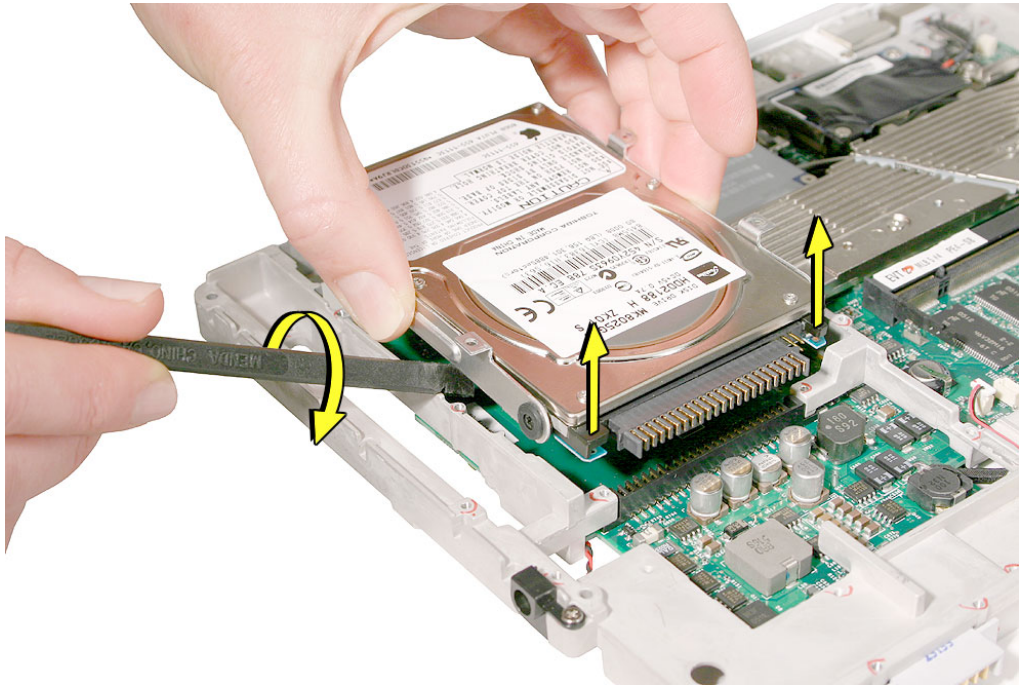

9. **Warning: If the connector is pulled off too quickly, some connector pins could become bent and damaged.**

Using gentle force, loosen one end of the connector just a bit, then loosen the other end. Carefully rock the connector in small, even increments to gradually disconnect it from the hard drive.

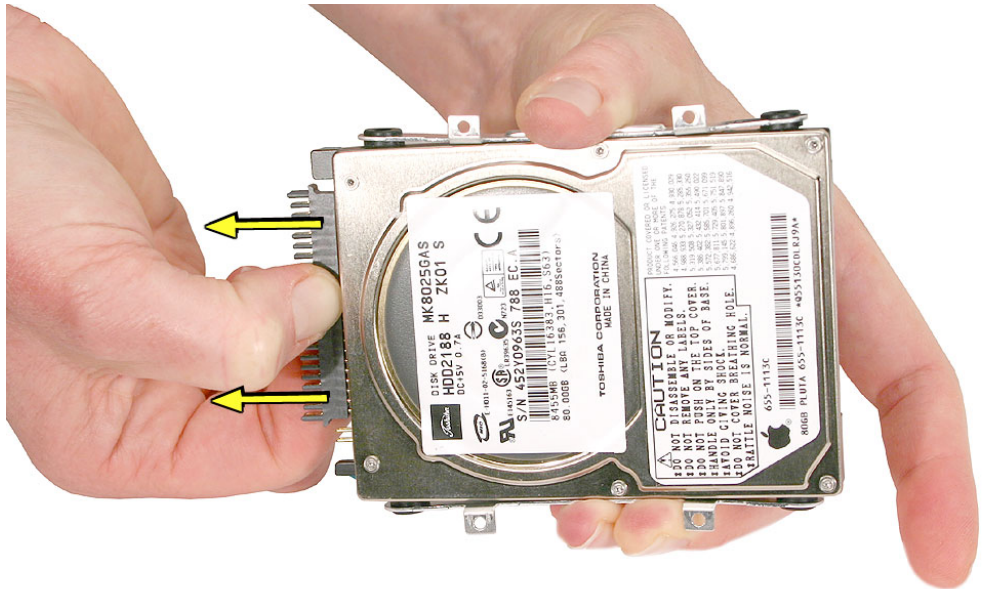

Important: If the hard drive pins become bent, use a black stick or jeweler's flat-blade screwdriver to carefully straighten the pins.

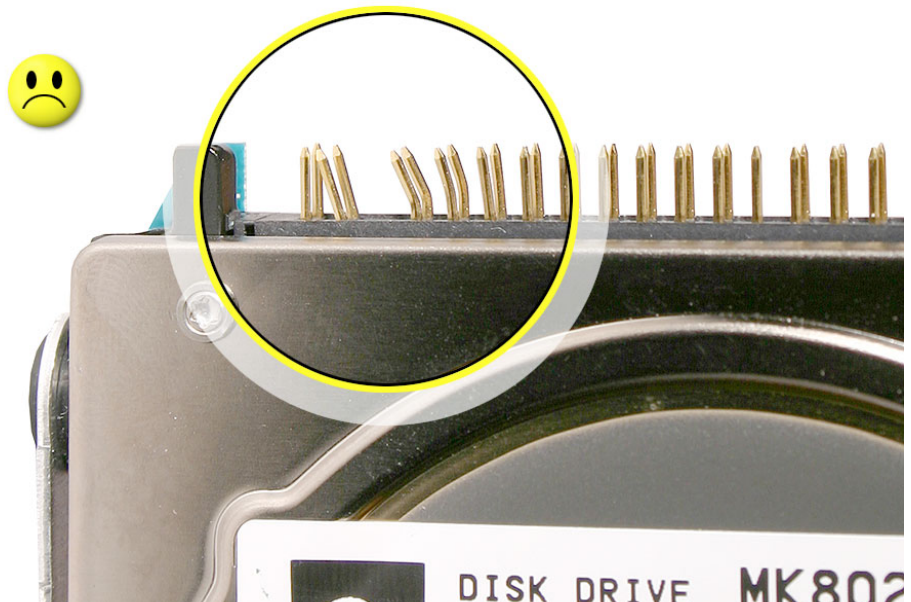

10. Remove the hard drive brackets (with grommets attached) by pulling them straight off the drive.

Note: When reassembling the computer, transfer both brackets (including the grommets) to the replacement hard drive so the grommets fit over the screw heads.

11. Using a Torx T8 screwdriver, remove the four identical, black, 7-mm long screws from the sides of the drive.

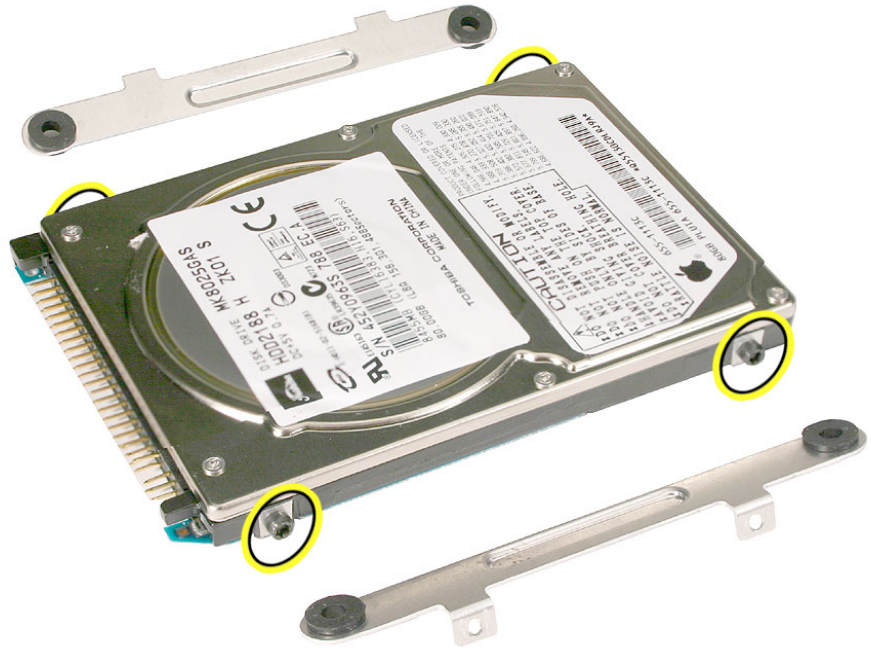

12. Install the replacement hard drive, and reassemble and test the computer. Follow these important replacement considerations:
 - **Important:** Before installing the hard drive direct-connect connector, find the open spaces on the drive and the connector. Make sure the "empty" space on the connector aligns with the "missing" pin on the hard drive.

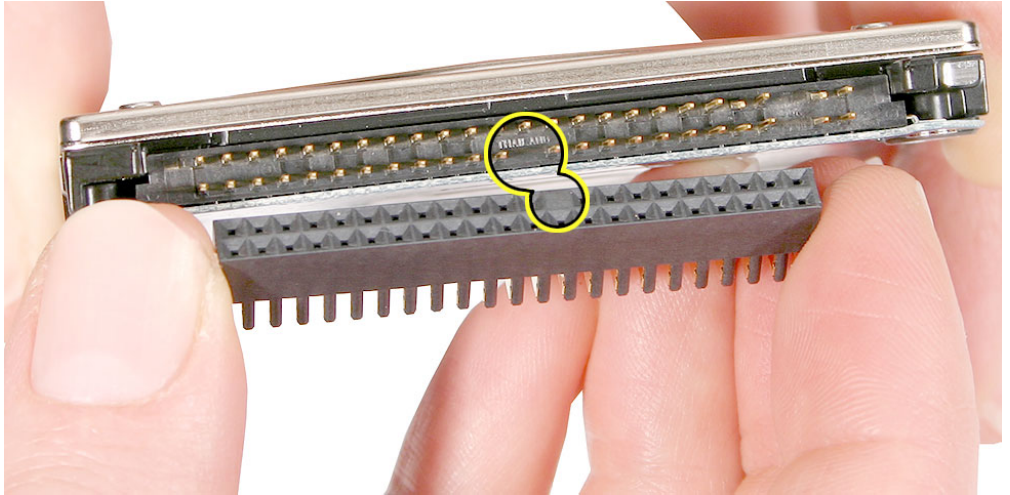

- With the direct-connect connector aligned correctly over the hard drive pins, carefully press down on one side of the connector.

Replacement Warning: To avoid bending the pins, do not force the connector onto the drive pins.

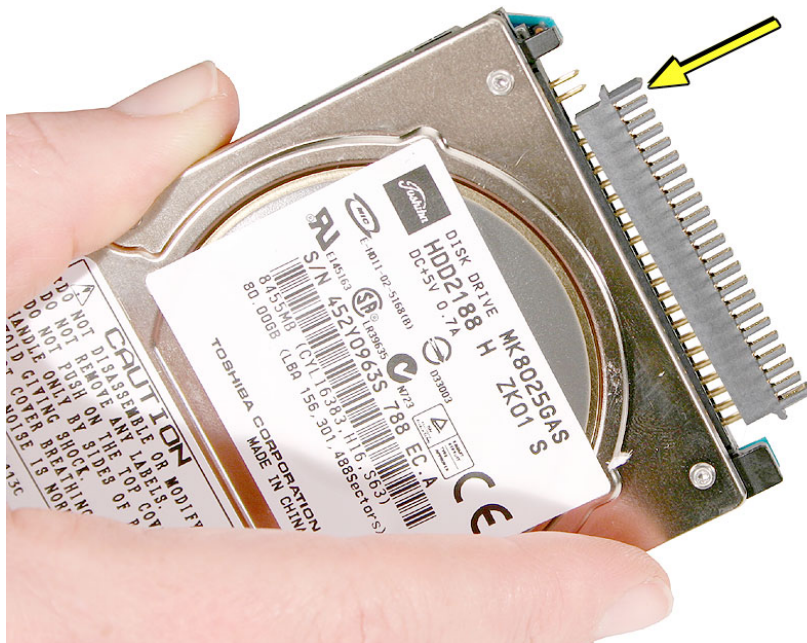

- Press the other end of the connector to slowly seat the connector all the way onto the drive.

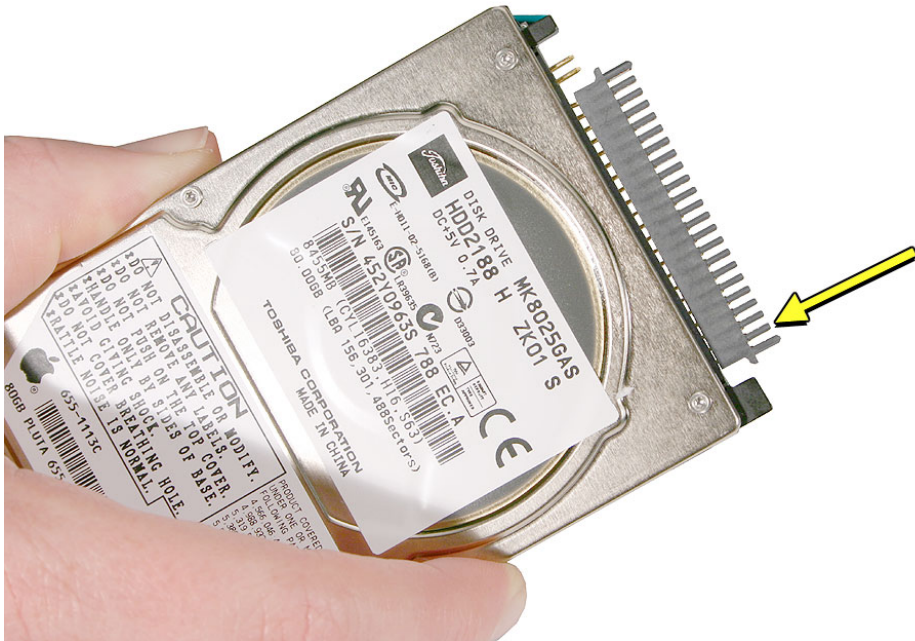

- **Important:** When setting the drive onto the logic board connector, tilt the drive slightly so that the connector slots align properly. Then level the drive, and make sure the brackets fit into the frame so that the grommets on the brackets match up with the holes in the frame. With the drive aligned properly, press on the connector to make sure it is fully engaged on the logic board.

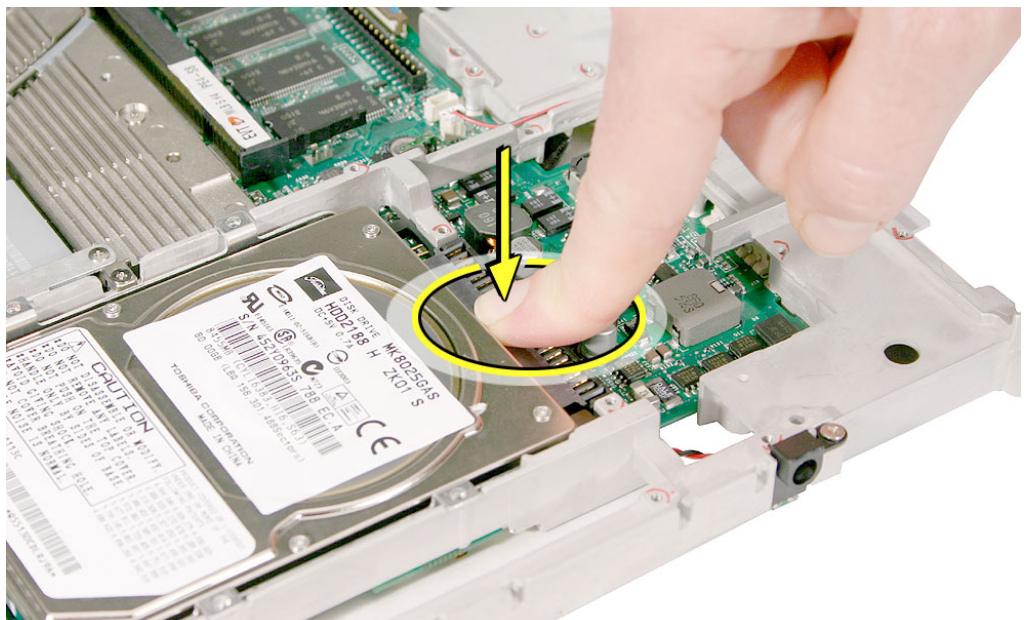

- Replace the hard drive brace, and install the two screws. Then install the four screws for the hard drive brackets.

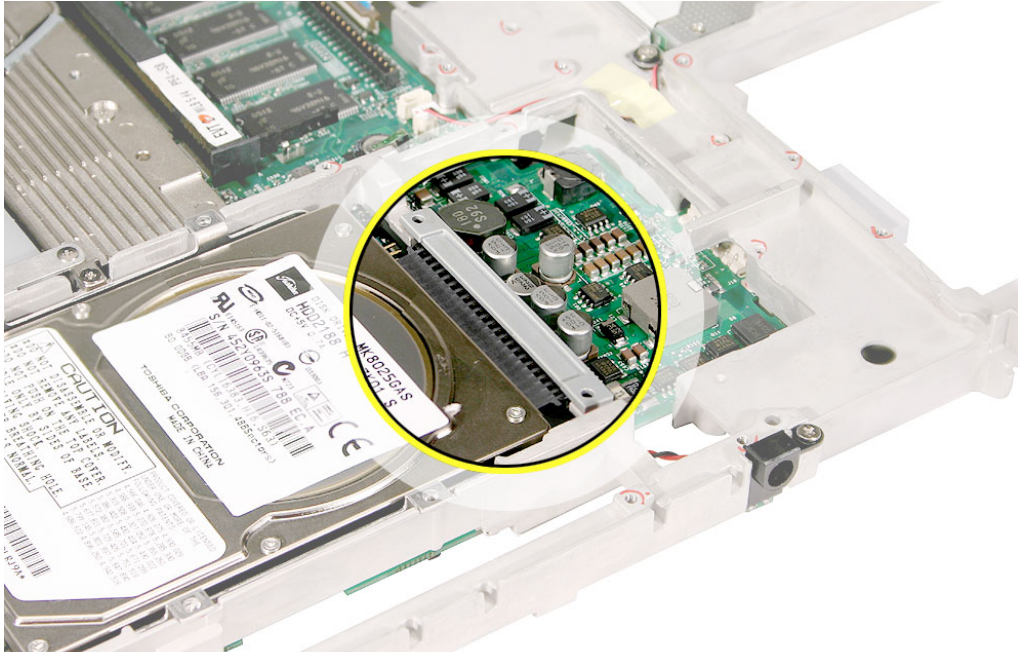



AirPort Extreme/Bluetooth Card

Tools

- Soft cloth
- #0 Phillips screwdriver
- Black stick (or other nonconductive nylon or plastic tool)

Part Location

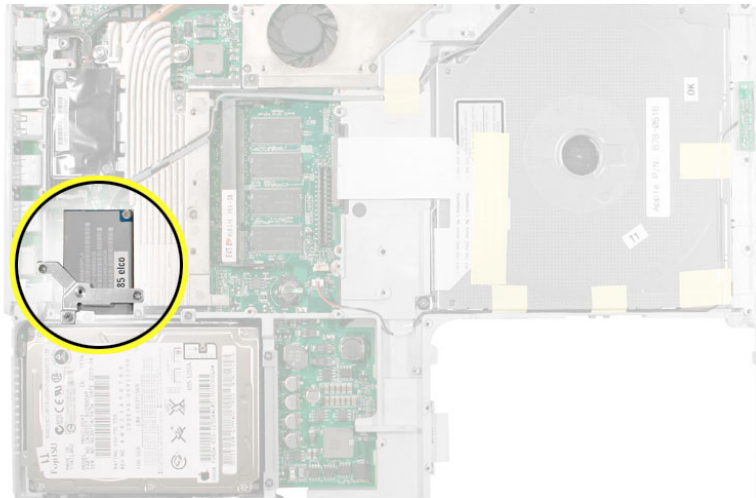

Preliminary Steps

Important: To avoid damaging the delicate connector on the AirPort Extreme/Bluetooth card, make sure you read and understand all of the instructions.

Before you begin, remove the following:

- Battery
- Keyboard and RAM shield
- Memory card
- Bottom case
- Bottom shield
- DC-in board
- Top case
- Top shield

Procedure

Important: Deviating from these steps could result in a damaged card. Make sure you read and understand all of the steps before removing or installing the card.

1. Remove the three identical 3-mm long screws from the Y-shaped bracket that fits over the AirPort Extreme/Bluetooth card.

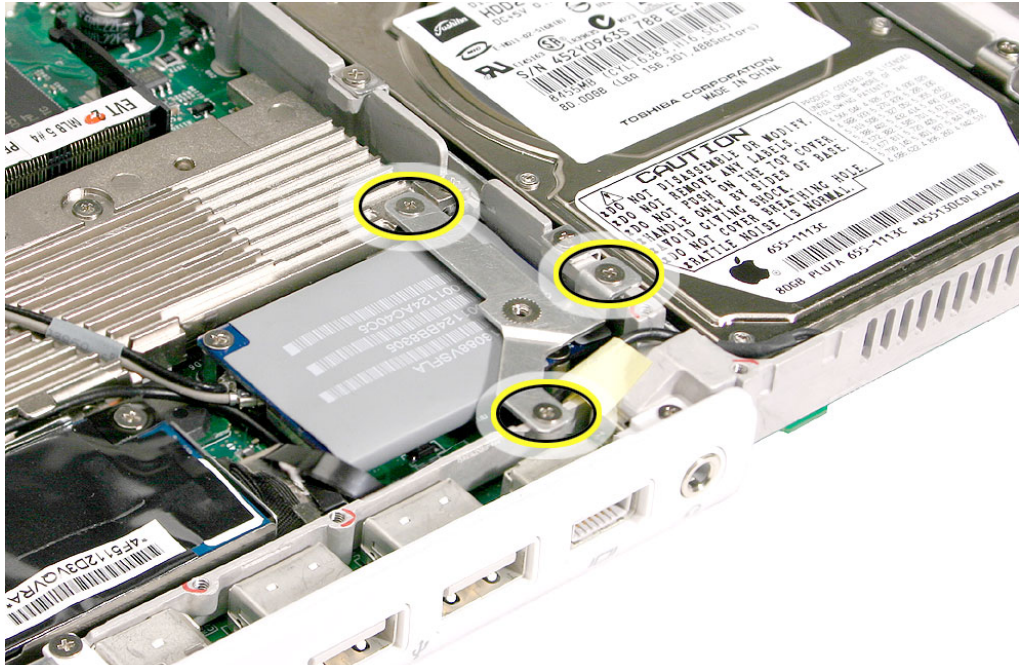

2. Lift off the Y-shaped bracket.

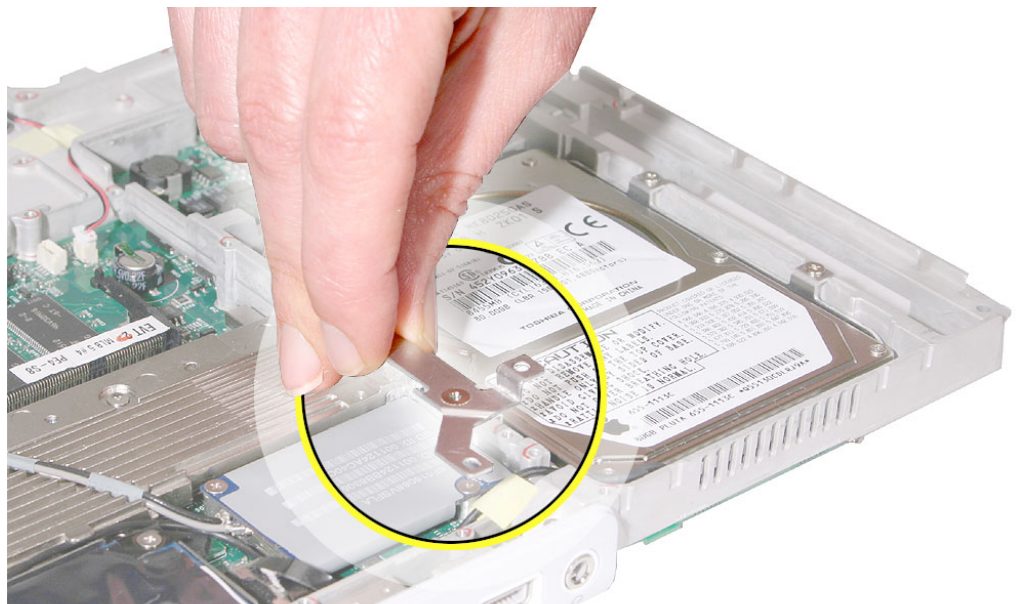

3. Remove the two identical 3-mm long screws from the AirPort Extreme/Bluetooth card.

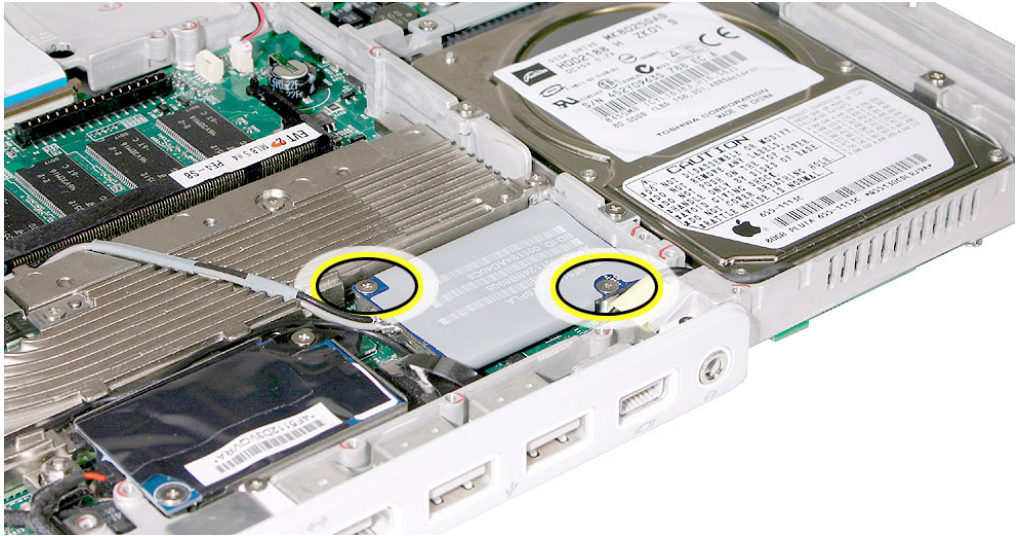

4. **Caution:** The connector that holds the card onto the logic board is delicate. Do not put pressure on the card, and do not deviate from these instructions.

Important: To disconnect the card, press on the corner of the card—only where shown—as you use a black stick at the side of the card, near the card connector, to slowly pop up the card. You should hear a soft "snap" when the card disengages from the logic board. To avoid damaging the card, hold it by its edges, and lift it straight up and off the connector on the logic board.



5. Peel up the tape, if present, that secures the antenna cables to the heatsink.

6. With the antenna cables still connected, turn over the card.
7. Note the location of the two cable connectors.

Replacement Caution: Although the cable connectors are identical, do not swap the cables. Make sure that when the card is oriented as shown, the black cable is positioned between the corner hole and the gray cable.

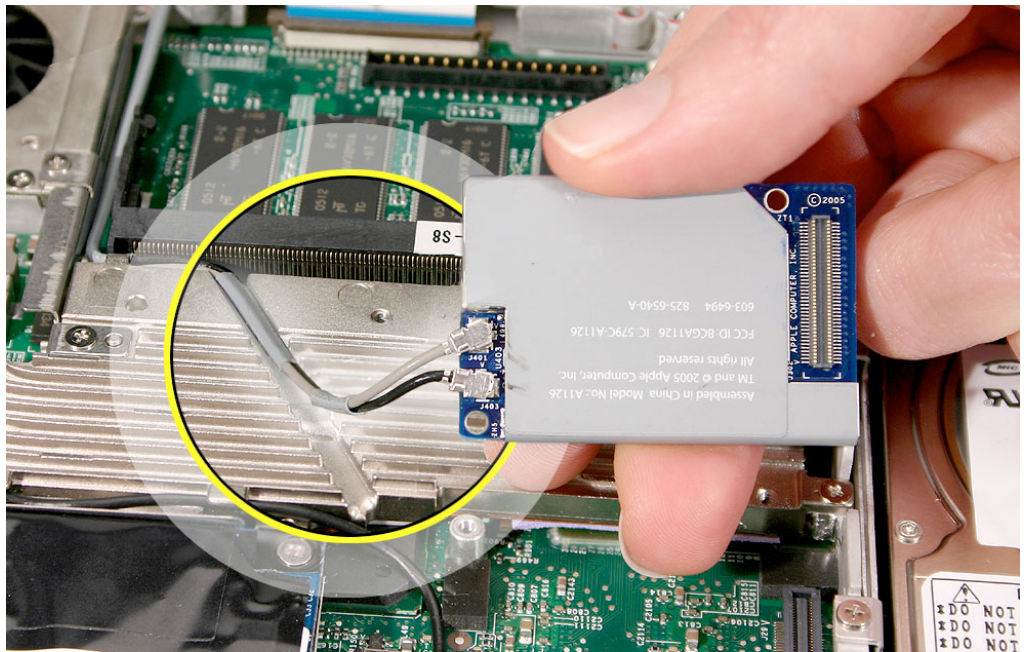
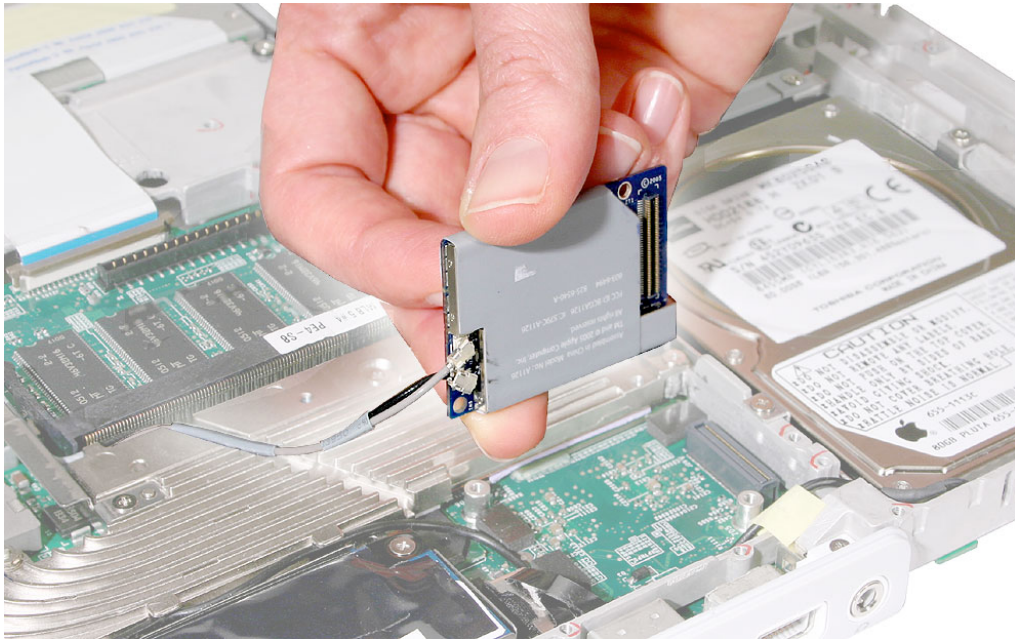

8. Disconnect the cables by pulling the connectors straight off the card. Remove the card from the computer assembly.

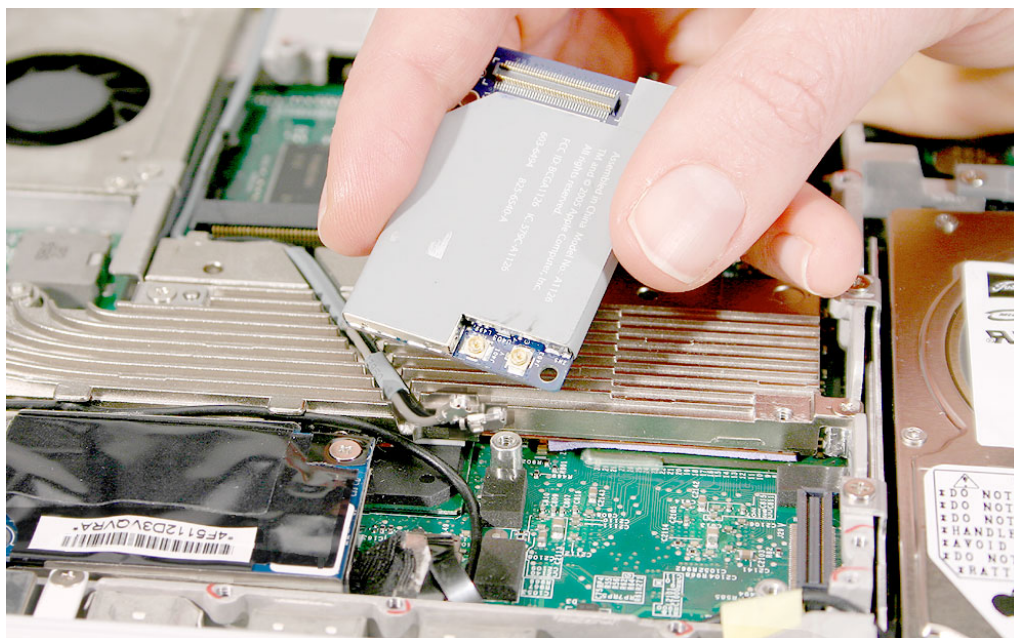
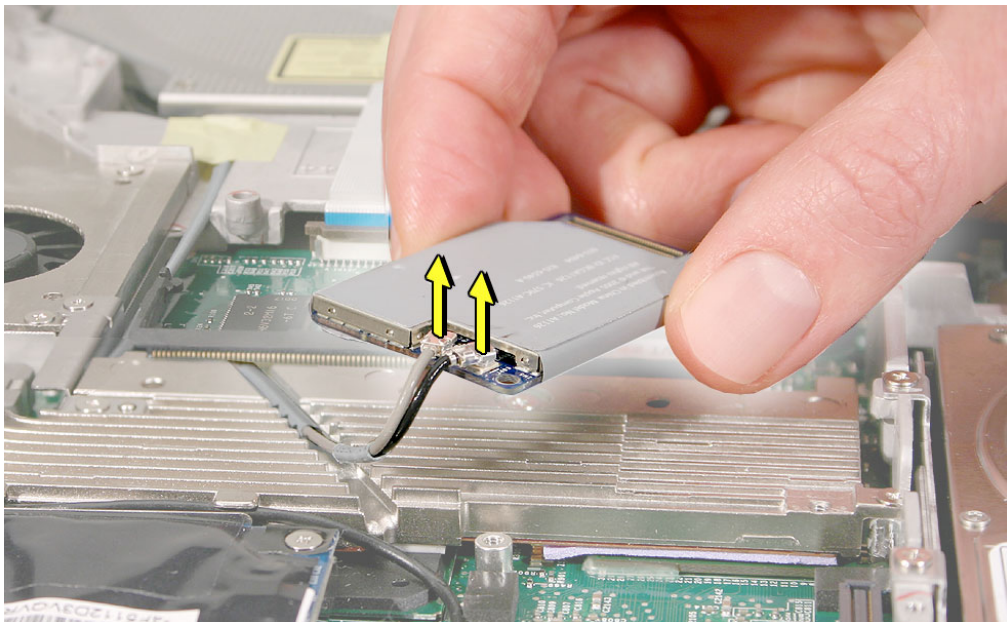

9. After connecting the antenna cables, install the replacement AirPort Extreme/Bluetooth card by aligning the card directly over the connector and pressing down on the board over the connector area only.

Important: A soft "snap" sound tells you that the card is connected to the logic board.

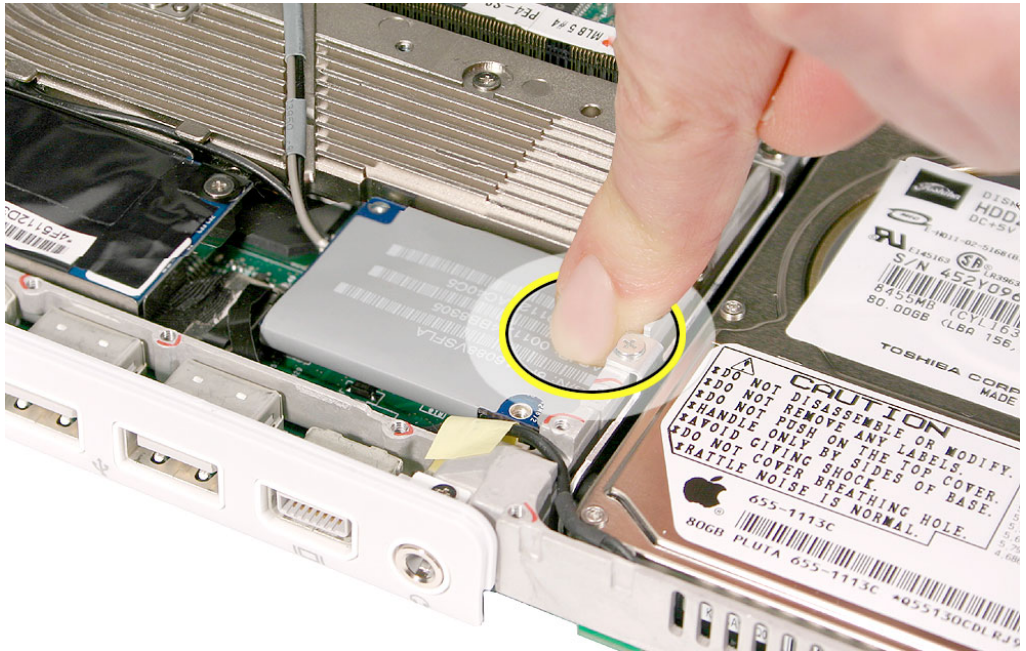

Make sure the antenna cables are routed over the heatsink, as shown. Then install the two card screws followed by the Y-shaped bracket and screws.

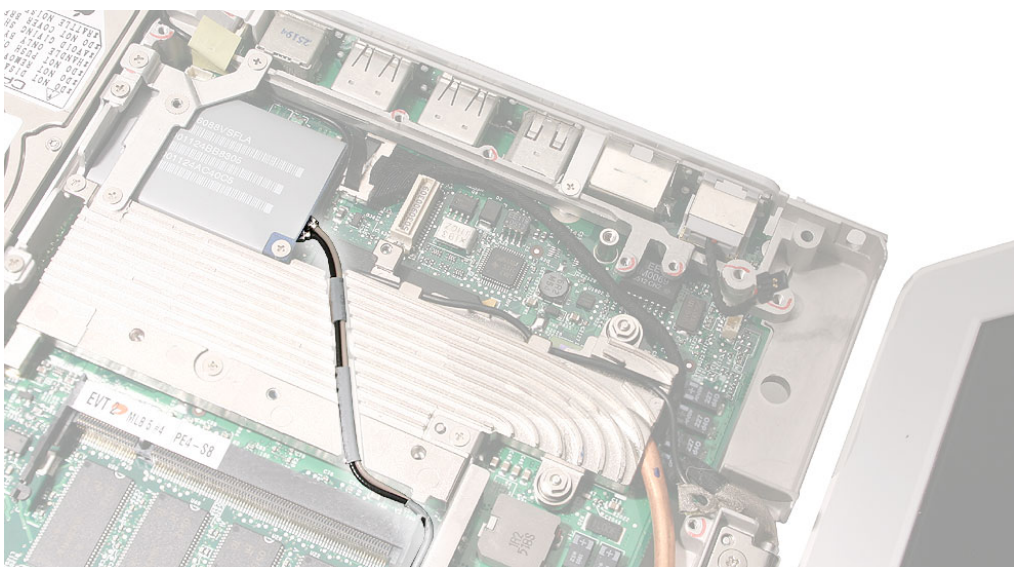

10. Reassemble and test the computer.



Modem

Tools

- Soft cloth
- #0 Phillips screwdriver
- Black stick (or other nonconductive nylon or plastic tool)

Part Location

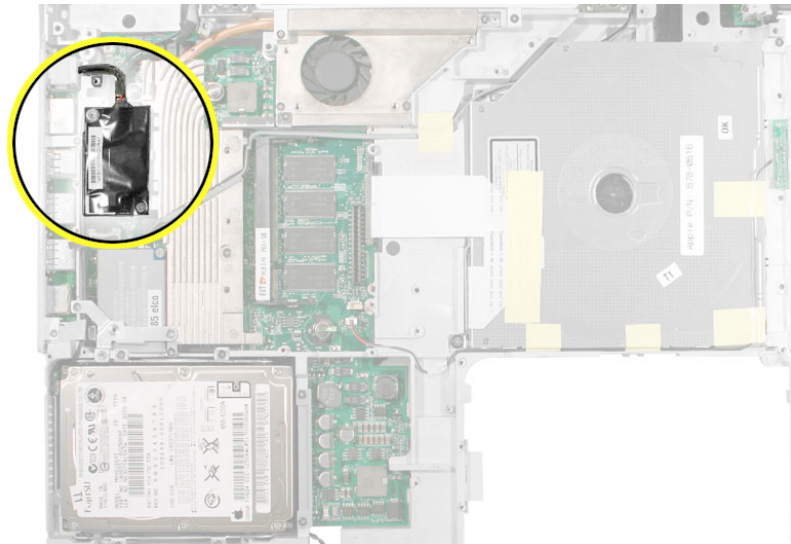

Preliminary Steps

Before you begin, remove the following:

- Battery
- Keyboard and RAM shield
- Memory card
- Bottom case
- Bottom shield
- DC-in board
- Top case
- Top shield

Procedure

1. **Warning:** When removing the modem, be careful not to strain the modem cable or shield. Read all of the procedure before removing and replacing the modem.
2. Peel up any strips of tape, if present, at the modem board.
3. Remove the two identical 3.5-mm long screws from the modem board.

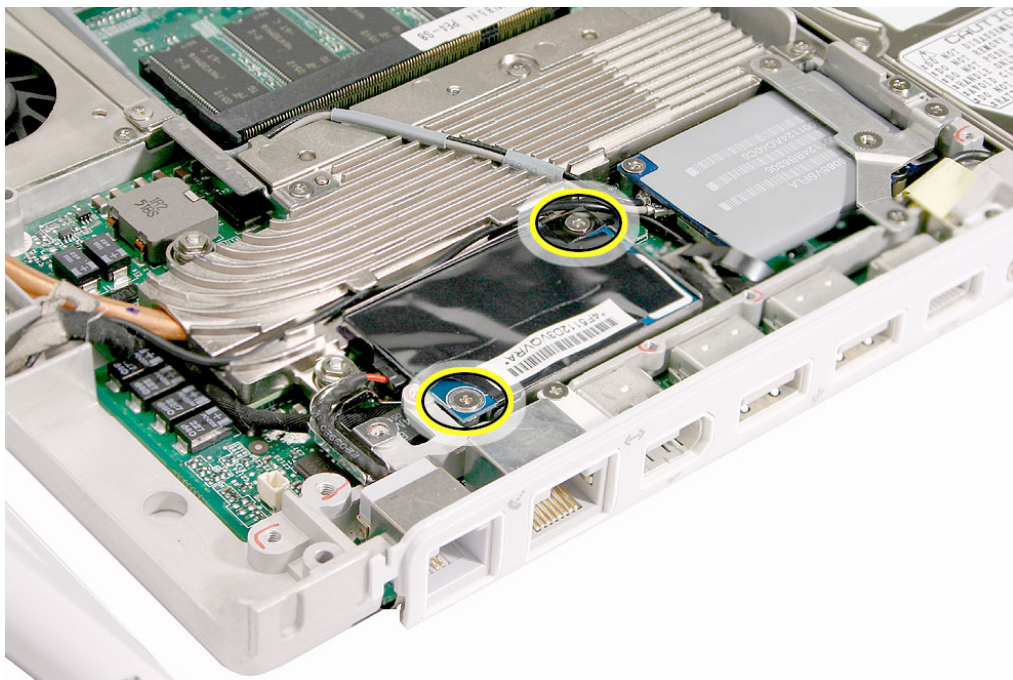

4. Use a black stick to lift up one end of the modem board. Grasp the edges of the modem to disconnect it from the computer.

Replacement Caution: Handle the modem by the edges only. When securing the modem to the logic board, press only on the area that is directly over the modem connector.

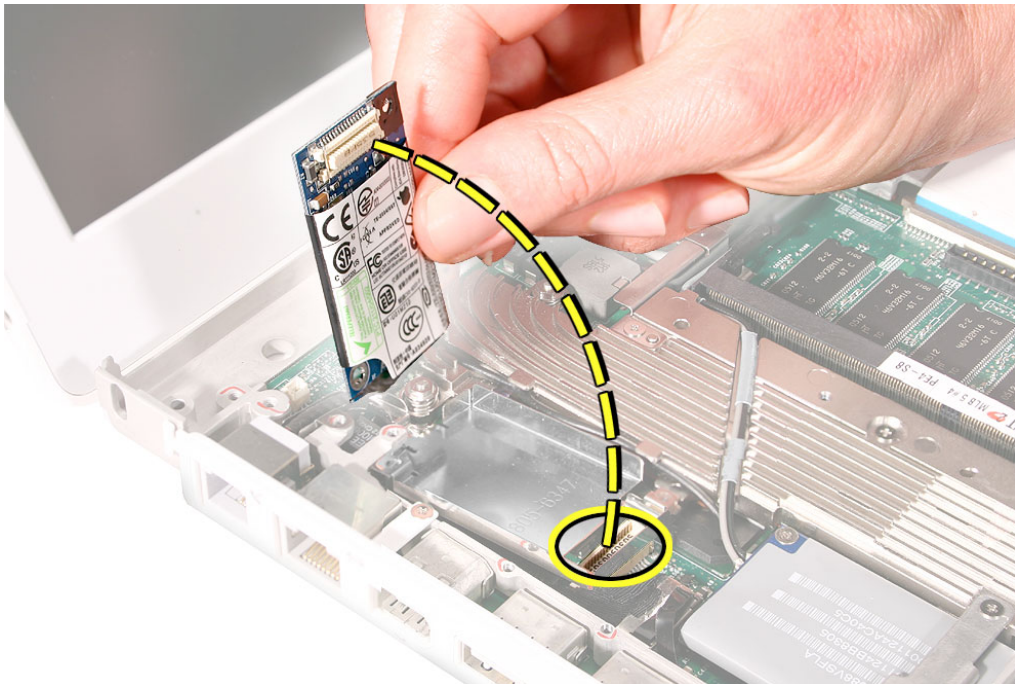
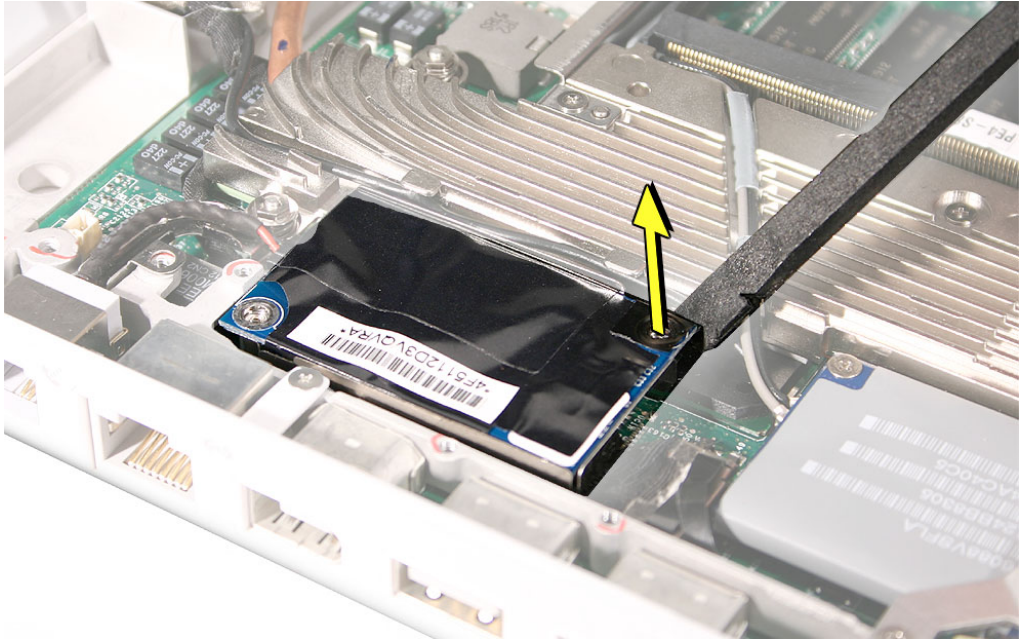

5. Disconnect the cable from the end of the modem board.

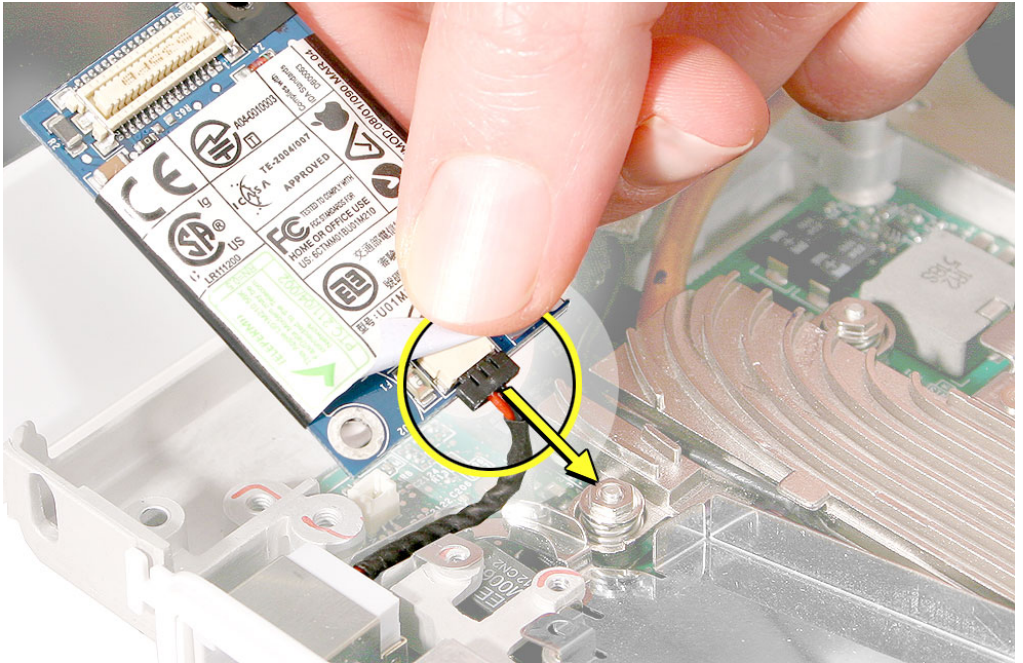

6. Remove the modem shield from the computer assembly.

Replacement Note: Before installing the replacement modem, make sure to fit it into the metal shield.

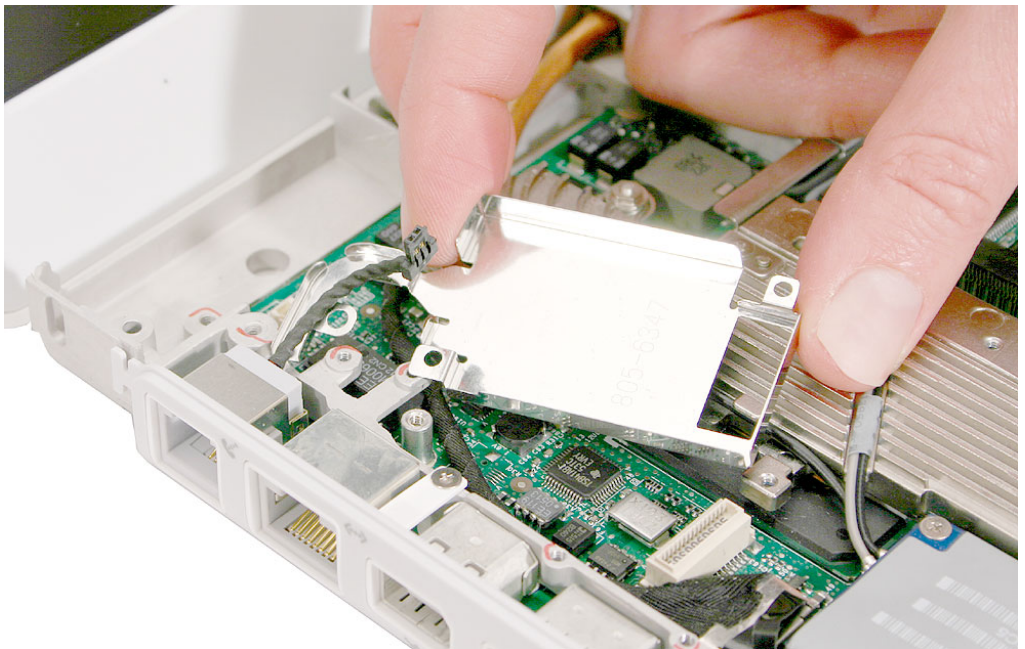

7. Install the replacement modem, and reassemble and test the computer.

Replacement Note: Before installing the replacement modem, make sure no cables are blocking the modem connector on the logic board.

Replacement Caution: With the modem connector centered over the connector on the logic board, press the modem onto the connector. Press only over the connector; do not press elsewhere on the modem.

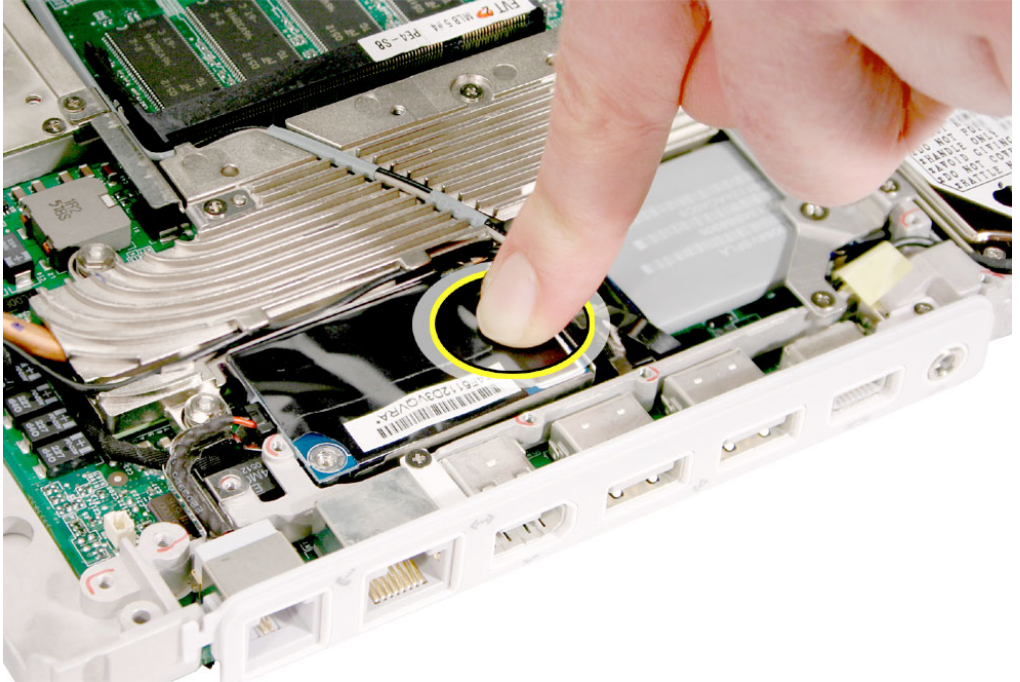



Reed Switch Board

Tools

- Soft cloth
- Black stick (or other nonconductive nylon or plastic tool)

Replacement Note: If the tape you remove from this assembly is worn and cannot be reused, use new Kapton tape (Apple part number 922-5025).

Part Location

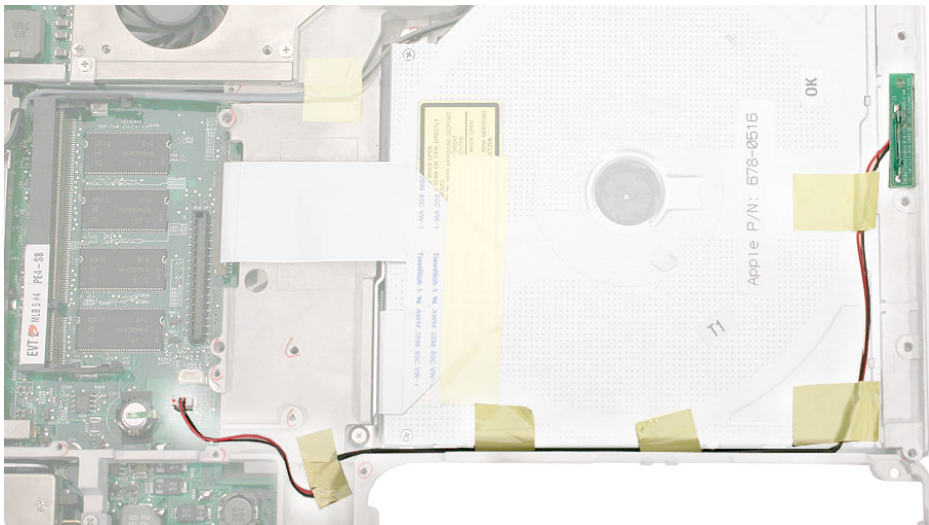

Preliminary Steps

Before you begin, remove the following:

- Battery
- Keyboard and RAM shield
- Memory card
- Bottom case
- Bottom shield
- DC-in board
- Top case
- Top shield

Procedure

1. Note how the reed switch cable is routed along the lower corner of the optical drive and connected to the logic board.

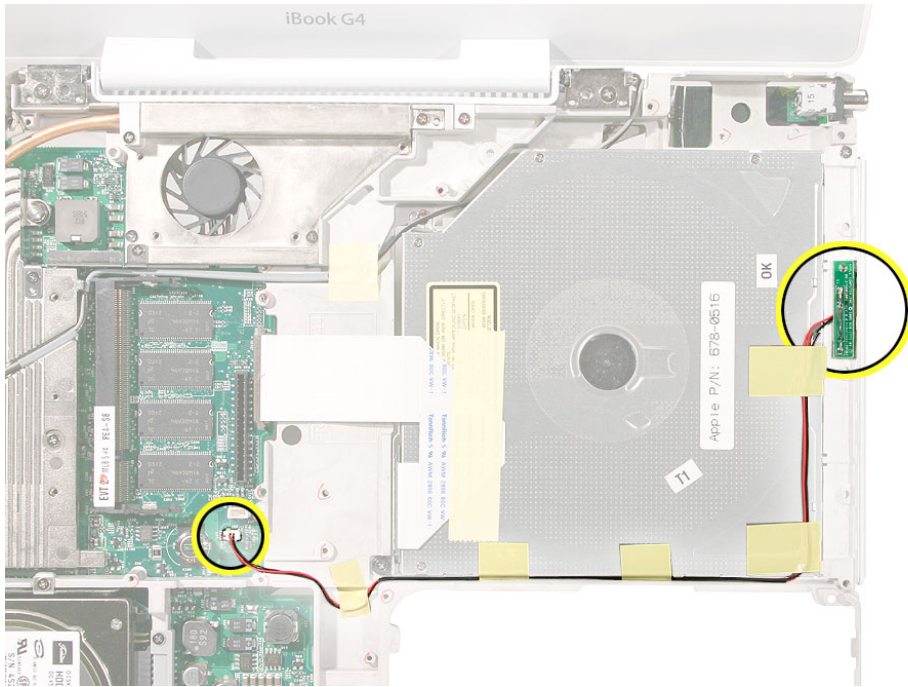

2. Disconnect the connector from the logic board.
3. Peel up or loosen the tape from the optical drive and frame.

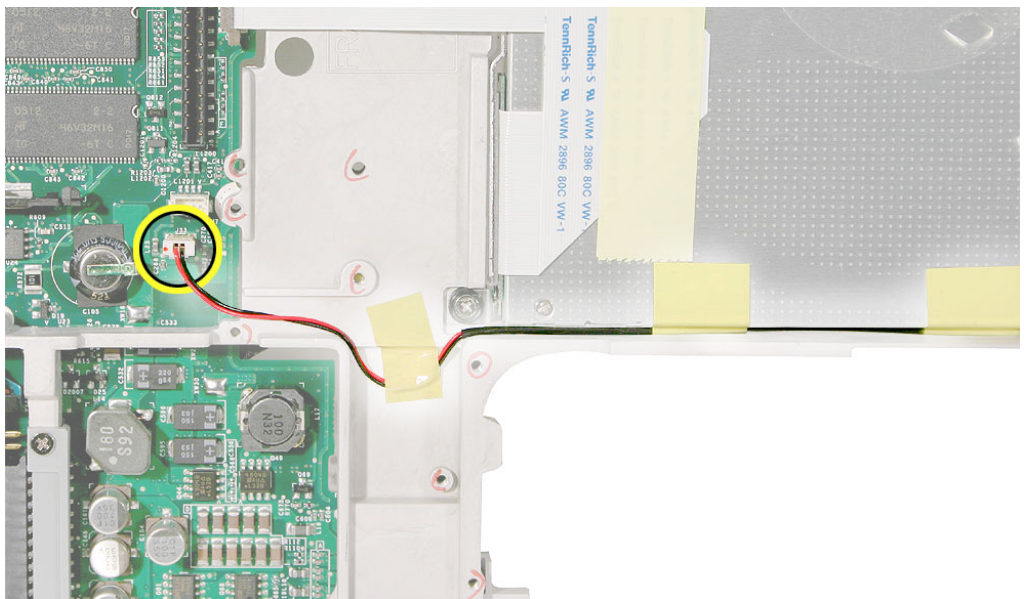

4. **Caution:** To avoid damaging the reed switch cable, slowly pull it up from the groove between the frame rib and the optical drive. Hold the tape aside as you guide the cable out of the groove.

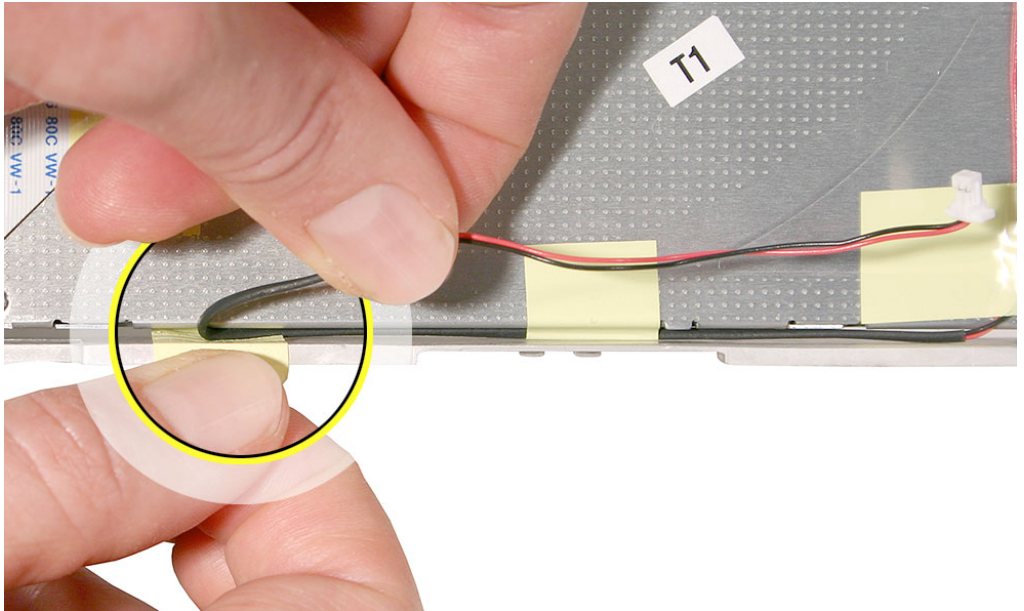

5. Use a black stick to pry up the reed switch board from the adhesive on the optical drive bezel.

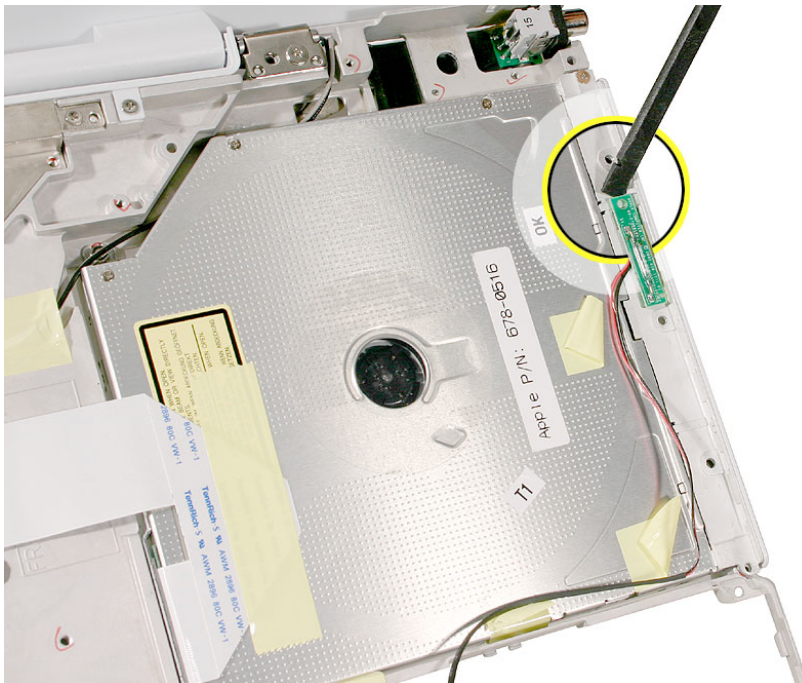

6. **Replacement Note:** When replacing the reed switch board, align the upper right corner with the raised L-shaped guide on the optical drive bezel.

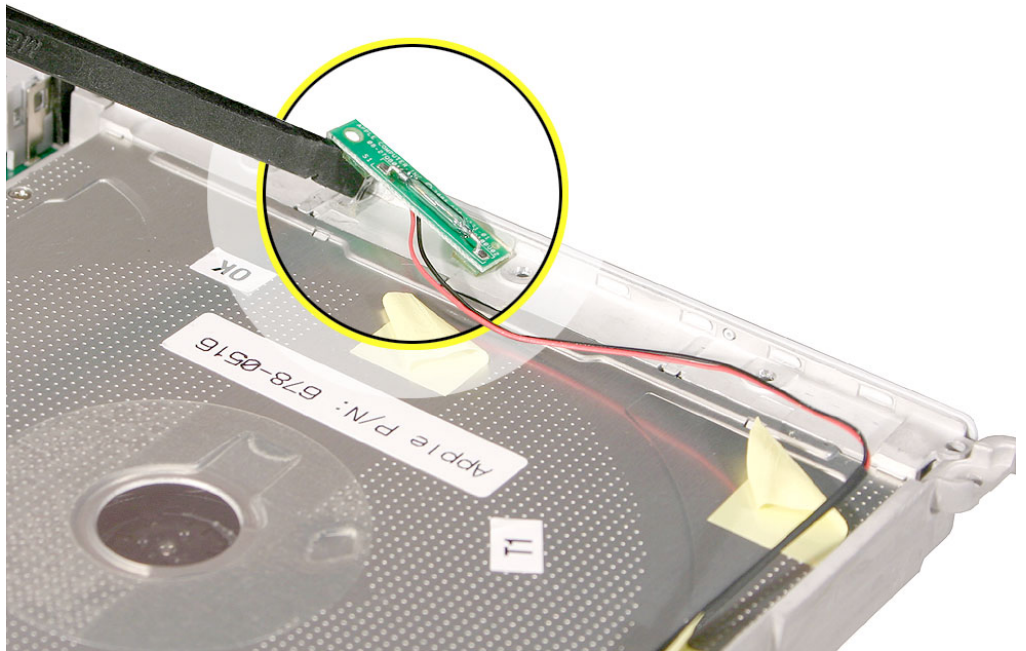

-
7. Remove the reed switch cable assembly.
 8. Install the replacement reed switch board and cable assembly, and reassemble and test the computer.

Be sure to tuck the cables into the groove at the lower edge of the optical drive.
Secure the cables with the tape provided.



Optical Drive

Tools

- Soft cloth
- #0 Phillips screwdriver
- Black stick (or other nonconductive nylon or plastic tool)

Note: To organize the screws you remove from the computer, use a tray with divided compartments (such as a plastic ice cube tray).

Part Location

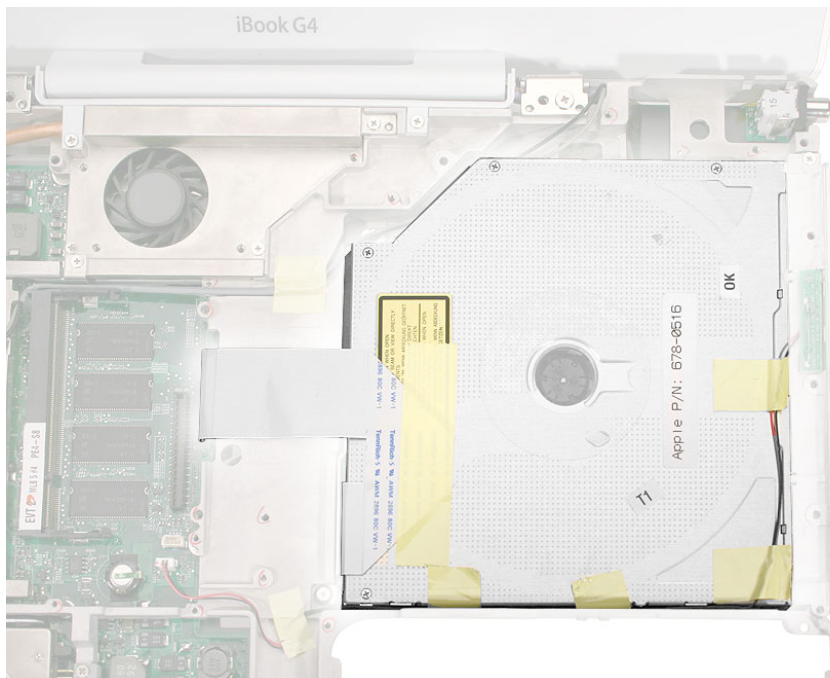

Preliminary Steps

Before you begin, remove the following:

- Battery
- Keyboard and RAM shield
- Memory

-
- Bottom case
 - Bottom shield
 - DC-in board
 - Top case
 - Top shield

Procedure

1. With the computer on a soft cloth, peel up any tape on top of the optical drive.
2. Remove the following from the optical drive:
 - 6-mm long screw at upper right corner of drive
 - 6-mm long screw at lower left corner of drive (this screw has an identifiable collar under the screw head)
 - 3-mm long screw at upper left corner of drive

Replacement Note: When replacing the optical drive, install the screws in the following sequence: lower left (1), upper right (2), upper left (3).

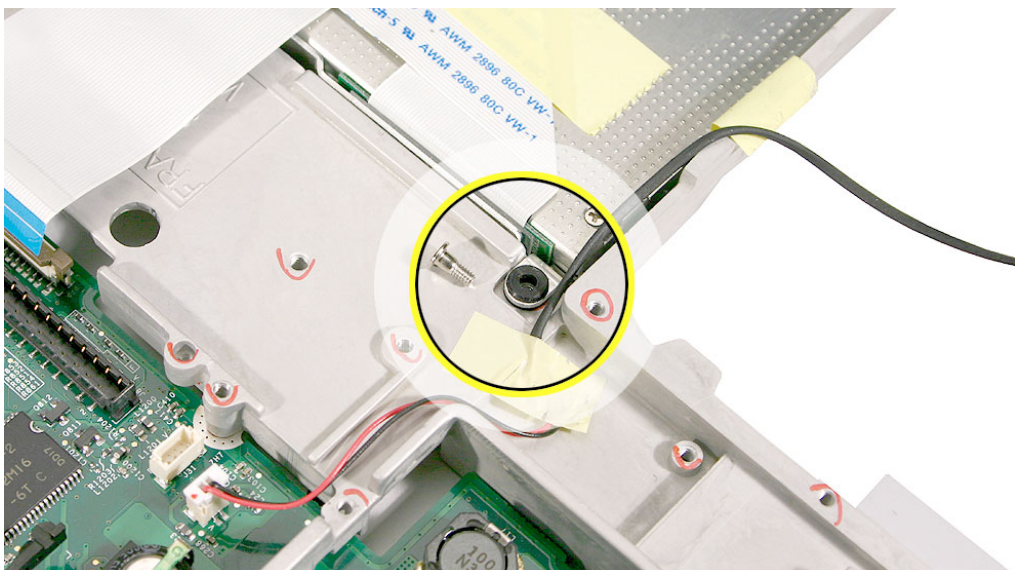
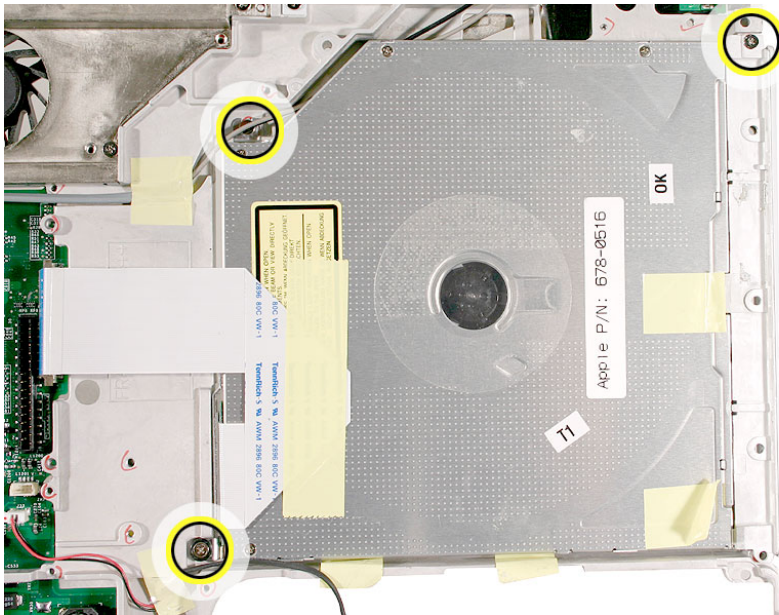

3. Move the reed switch cable aside.

Note: You do not need to completely remove the reed switch board and cable.

4. Disconnect the optical drive ribbon cable from the logic board.

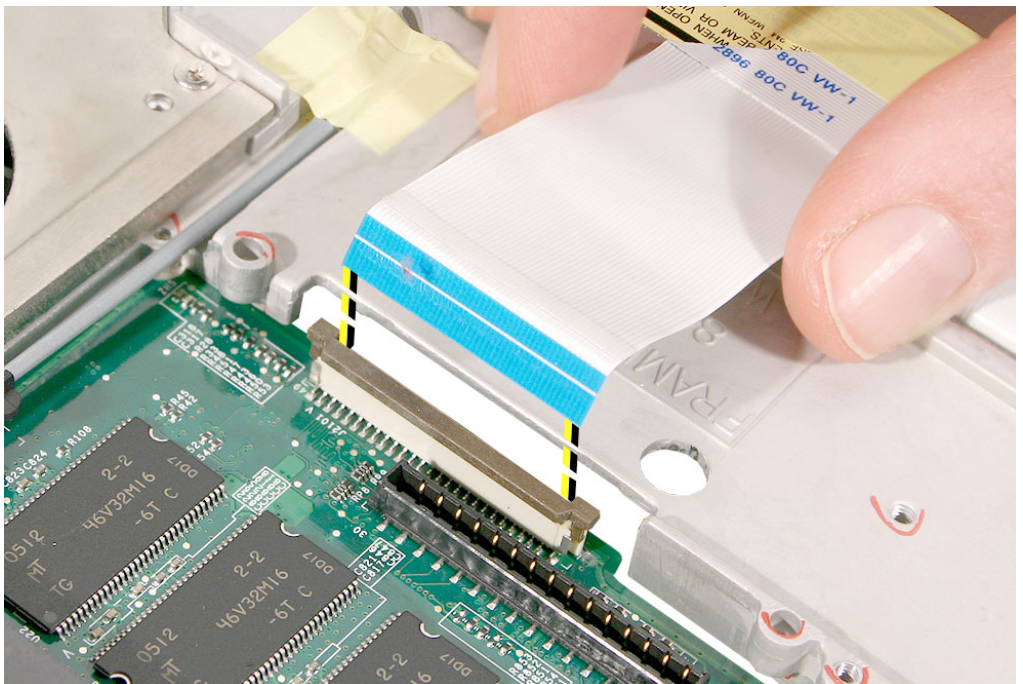
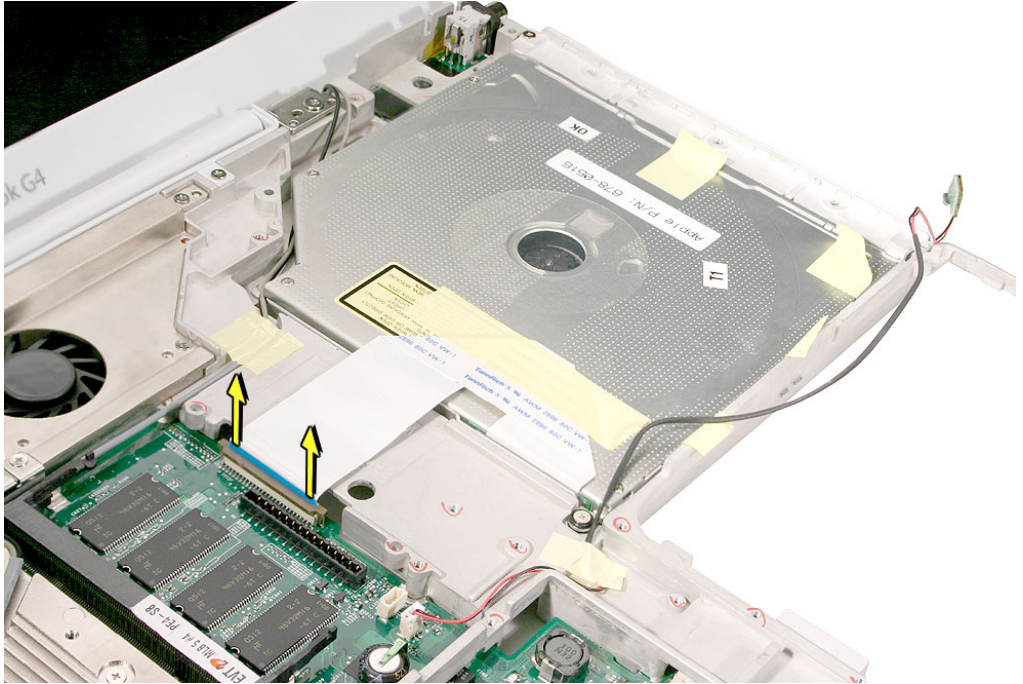

5. **Warning: Handle the optical drive at the sides only. Do not touch or press anywhere else on the drive.**

Without pinching any cables, tilt up the optical drive and lift it out the drive.

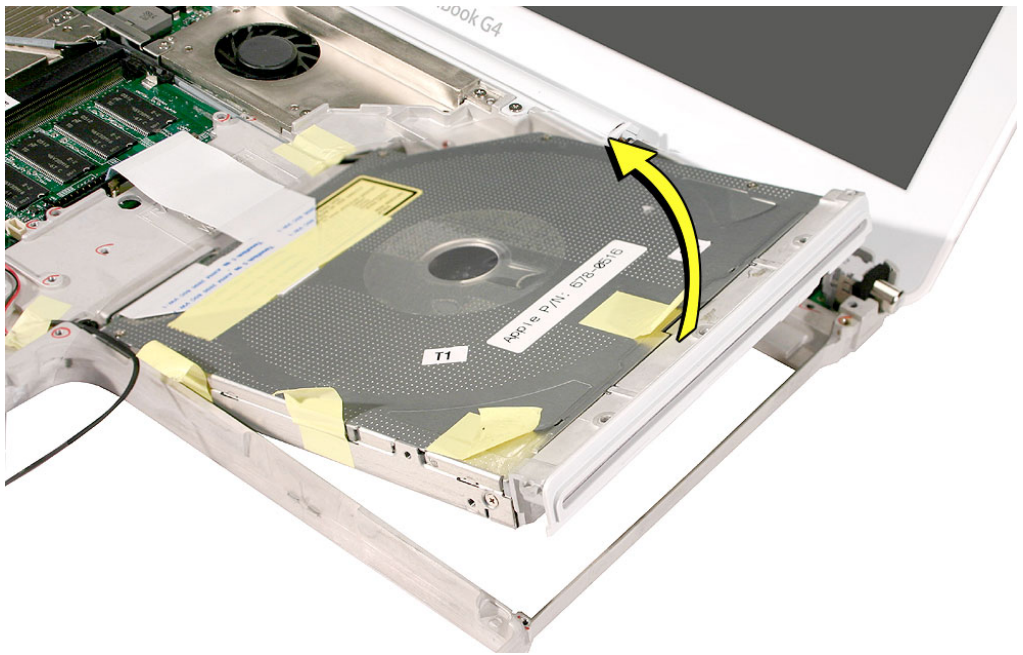

6. Remove the two identical 3-mm long screws that hold the bracket to the optical drive.
7. Remove the cable bracket.

Note: When reassembling the computer, transfer the cable bracket to the replacement drive.



8. Peel off the tape from the optical drive, and use a black stick to disconnect the ribbon cable.

Note: When reassembling the computer, transfer the ribbon cable to the replacement drive.

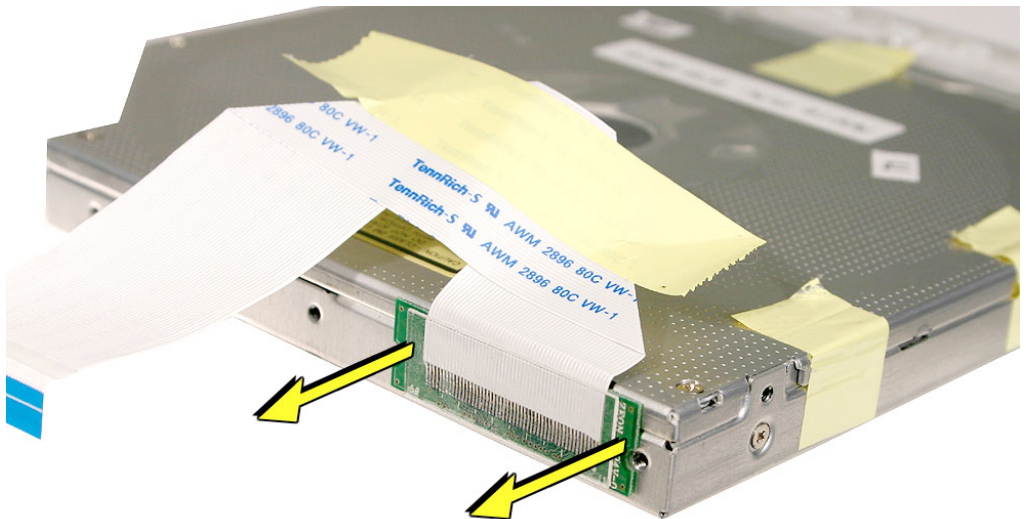

- Remove the 4.5-mm long screws that hold the mounting bracket to the optical drive. Although the three screws are the same length, the screw that secures the bracket to the bezel is a different shape (no collar), while the other two have collars.

Important: When reassembling the computer, transfer the mounting bracket to the replacement drive.

Replacement Warning: Make sure you use the collar-less screw to secure the mounting bracket to the bezel.



10. With the pointed end of a black stick, press lightly on the three tabs, and tilt the bezel up and off of the drive.

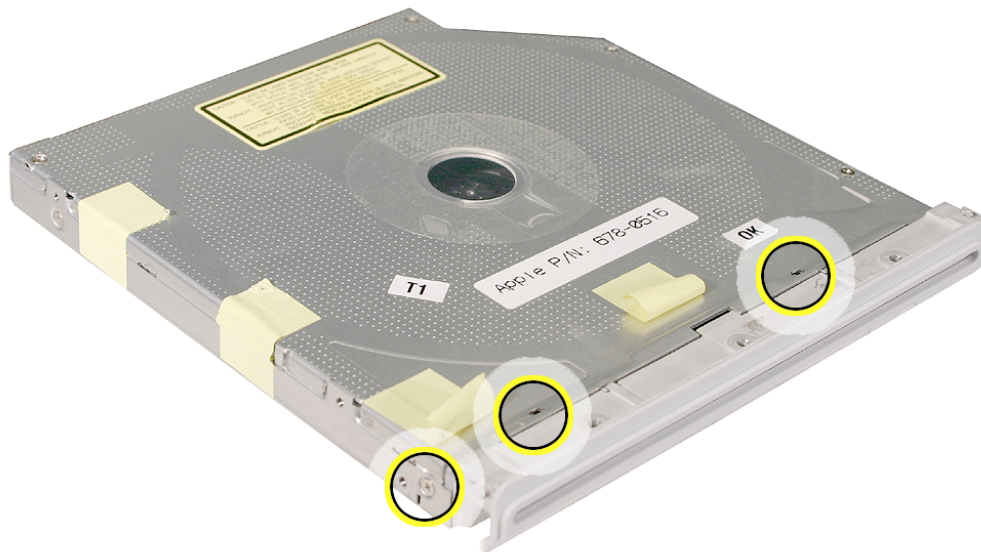

-
11. Install the replacement optical drive, and reassemble and test the computer.

Replacement Note: When installing the replacement optical drive, align the front of the drive bezel to the outer edge of the frame first. Make sure the screw holes align. Check that the felt at the slot opening is even and not mashed.





How to Remove a Stuck Disc from the Slot-Load Drive

The following instructions explain how to remove a disc that is stuck in the slot-load optical drive.

Important: When a disc becomes stuck in the slot-load optical drive, it makes the drive unusable. Make sure you have a replacement drive available.

Tools

This procedure requires the following tools:

- ESD wriststrap and mat
- #0 Phillips screwdriver
- Black stick (or other nonconductive nylon or plastic tool)

Preliminary Steps

Before you begin, remove the optical drive from the computer. If brackets, a cable, and a faceplate are attached to the drive, use a screwdriver and black stick to remove them.

Note: The following image shows a sample drive with brackets, cable, and faceplate attached. Your drive might have a different appearance.

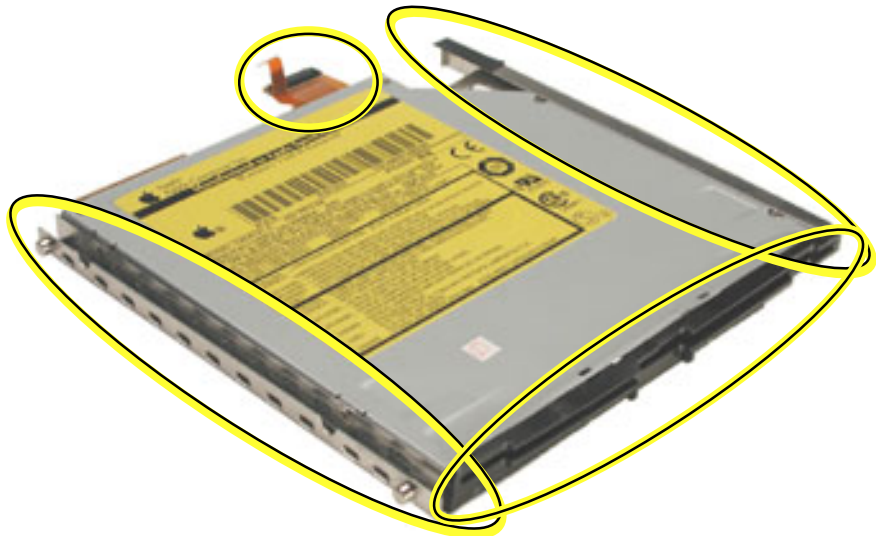

Procedure

1. Remove the four identical screws that hold the top cover to the drive.



2. Slide the top cover approximately 2 mm toward the back of the drive. Lift up the top cover to remove it.



3. Check the placement of the disc. It is either clamped to the turntable at the center of the disc, or it is wedged under one or more posts at the outer edge of the disc.
4. Holding the edge of the disc, press on the center clamp or hold the posts steady as you remove the disc from the drive.

Important: Do not touch any key components located near the disc.



5. Replace the top cover on the drive so that the small hooks on the top cover fit into the slots on the bottom cover. Then slide the top cover into place.



6. Replace the four screws. If applicable, install the brackets, cable, and faceplate back on the drive before returning the old drive.
7. Install the replacement drive, and reassemble and test the computer.



Display Module

Tools

- Soft cloth
- #0 Phillips screwdriver
- Black stick (or other nonconductive nylon or plastic tool)

Note: To organize the screws you remove from the computer, use a tray with divided compartments (such as a plastic ice cube tray).

Part Location



Preliminary Steps

Before you begin, remove the following:

- Battery
- Keyboard and RAM shield

- Memory card
- Bottom case
- Bottom shield
- DC-in board
- Top case
- Top shield
- Modem
- AirPort Extreme/Bluetooth card (or just the Y-shaped card holder)

Procedure

1. With the computer on a soft cloth, note the routing of the thin, black microphone cable and the LVDS (low voltage data signal) cable.
2. Disconnect the microphone cable from the logic board near the hard drive.
3. Pull up the flexible tab to disconnect the LVDS cable from the logic board.

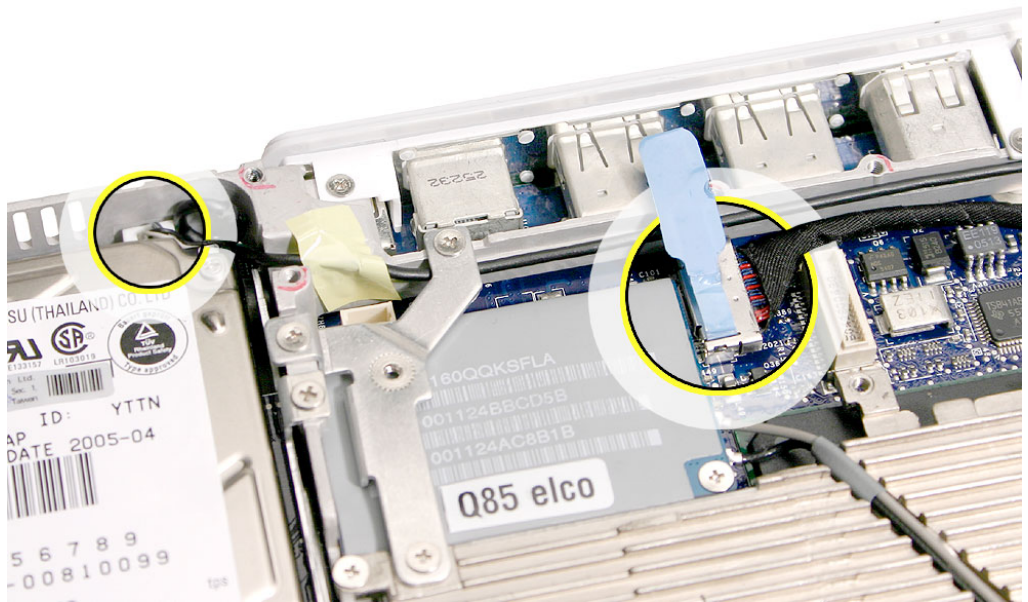

4. Starting at the LVDS cable connector, carefully pull up on the cable to remove it from the computer assembly.

- Starting at the microphone cable connector, carefully pull up on the cable to remove it from the computer assembly.

Note: The image below shows the correct cable routing with the AirPort Extreme/Bluetooth card in place. However, you need to remove the Y-shaped card holder to release the microphone cable.

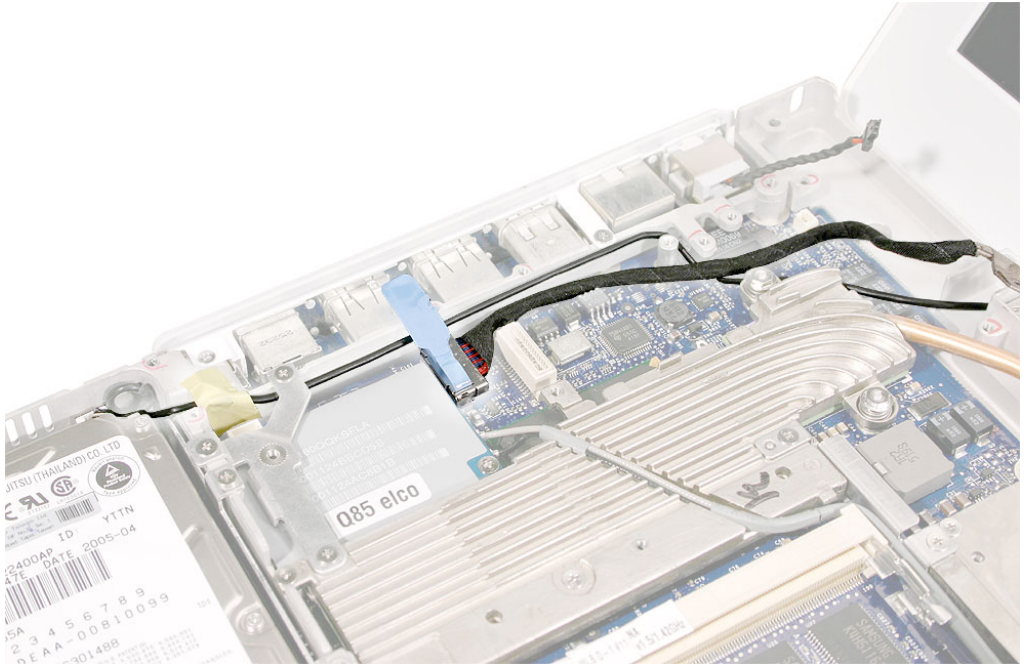

- Carefully route the AirPort antenna cable out from under the optical drive.

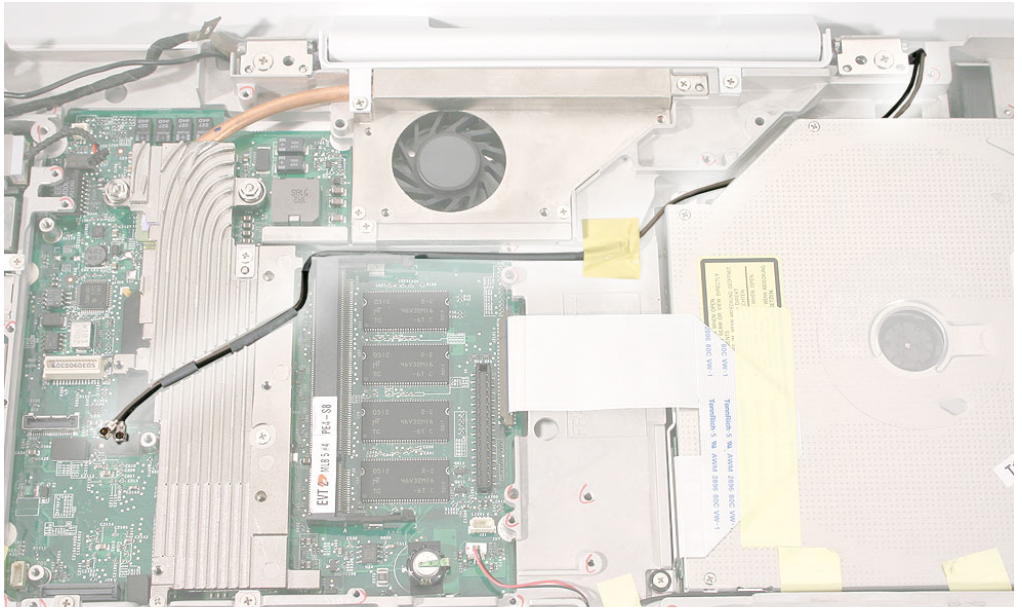

- Peel off any tape that holds the cables to the frame.
- Without straining the cables, lift them up from the logic board.
- While supporting the display, turn over the computer, and disconnect the inverter cable from the underside of the logic board.

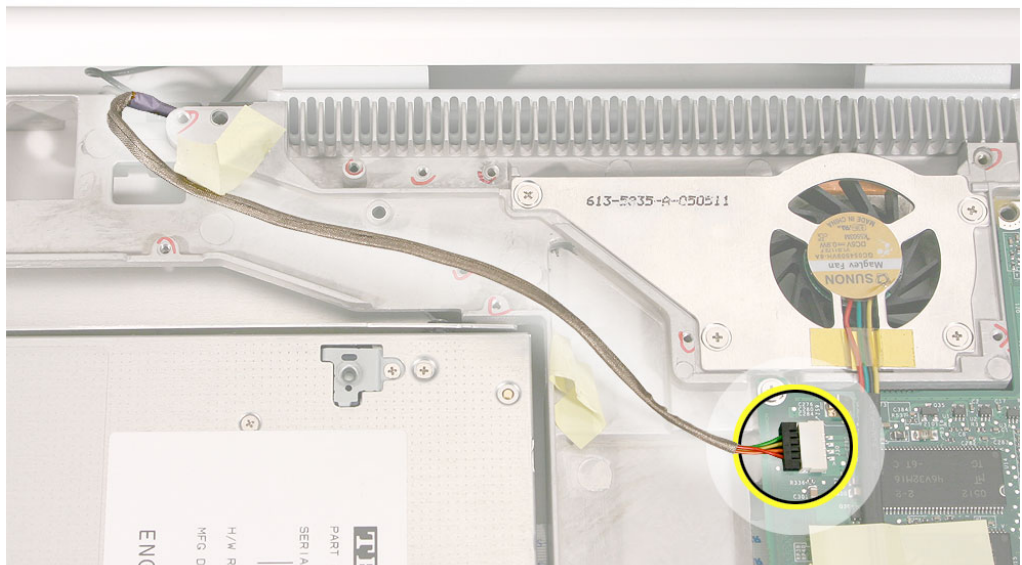

-
10. **Warning: To prevent damage, support the display while performing this step.**
Remove the screw at each display hinge.



11. **Warning: When lifting the display, be careful not to strain the cables.**
Remove the display from the computer chassis.
12. Install the display module, and reassemble and test the computer.

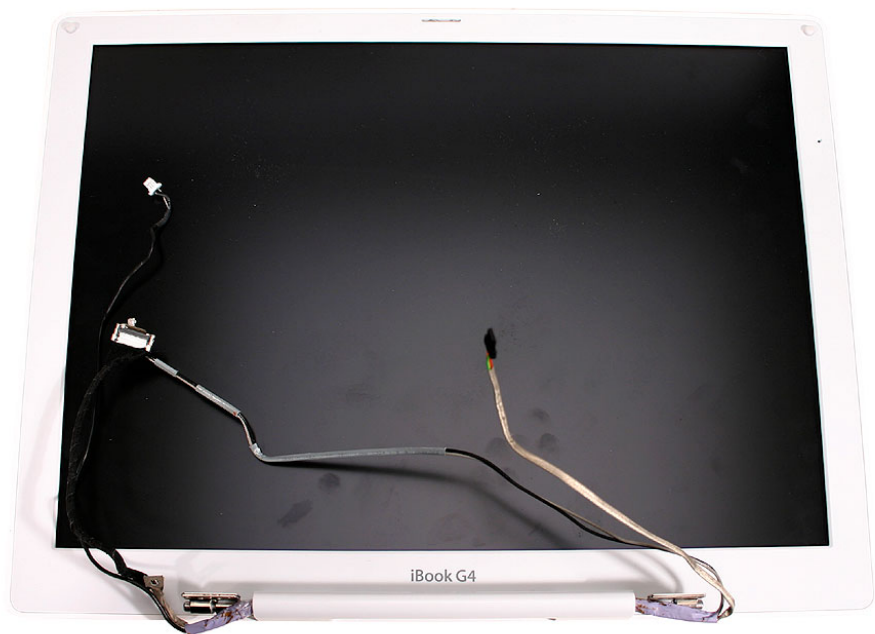

Replacement Note: As you reassemble the computer, make sure cables are secure, and the cables from the display are routed as shown.

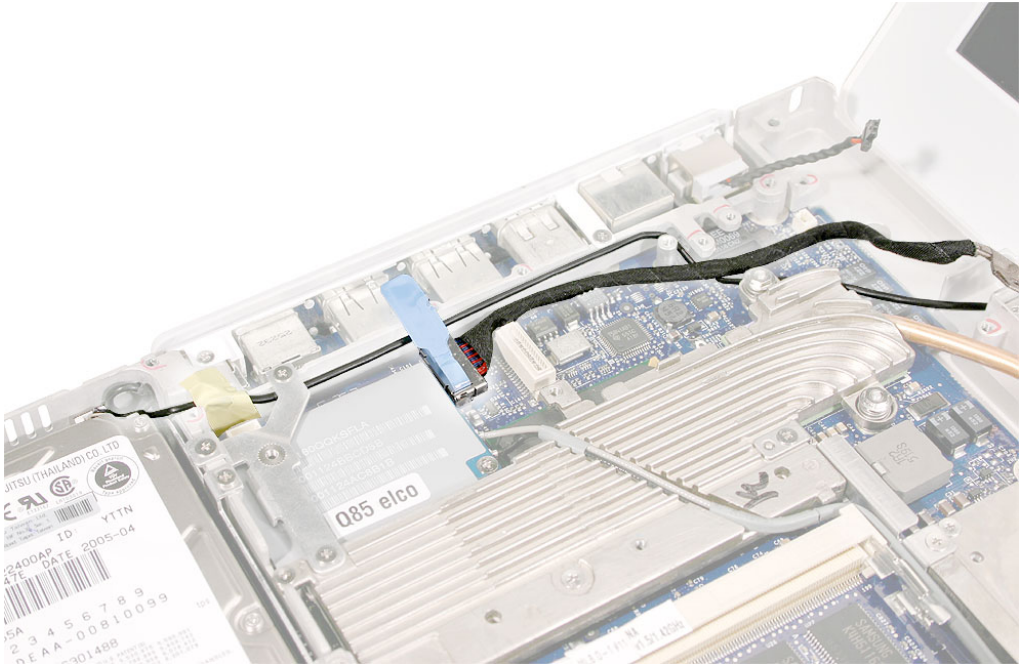



Vent Cover

Tools

- Soft cloth
- #0 Phillips screwdriver

Part Location

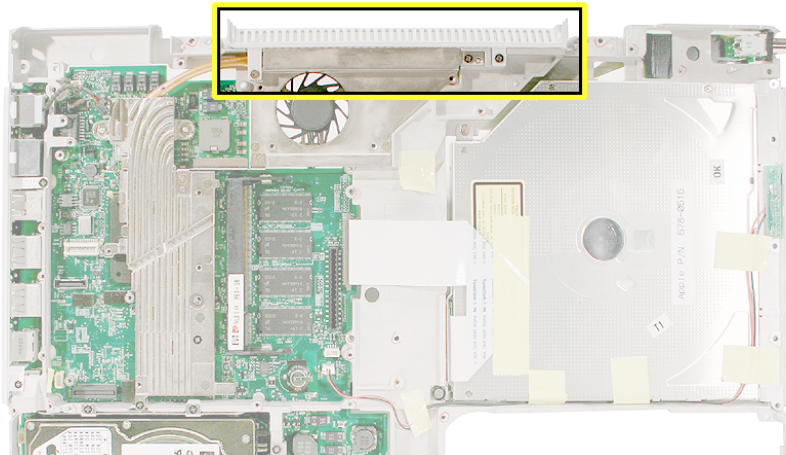

Preliminary Steps

Before you begin, remove the following:

- Battery
- Keyboard and RAM shield
- Memory card
- Bottom case
- Bottom shield
- DC-in board
- Top case
- Top shield
- Modem
- AirPort Extreme/Bluetooth card
- Display

Procedure

1. With the computer on a soft cloth, remove the vent cover screws.

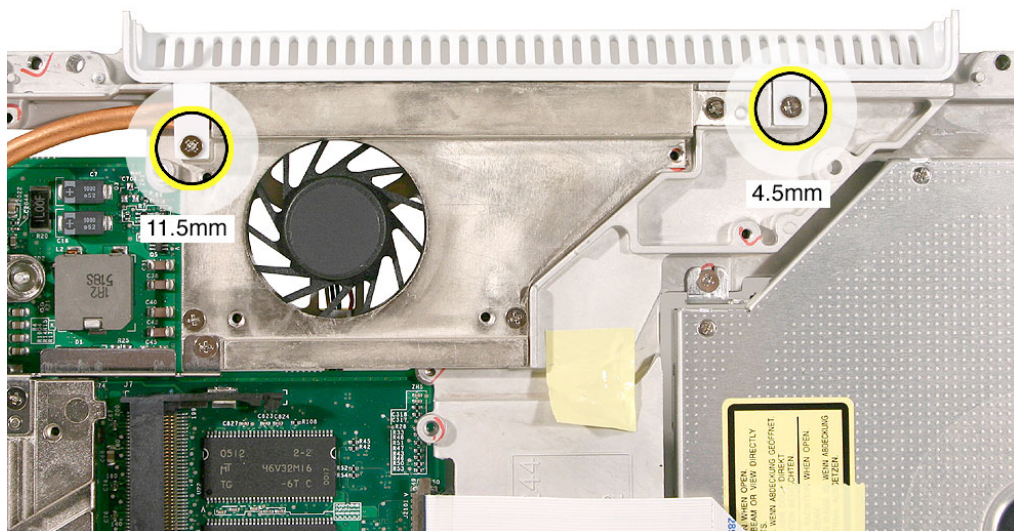

2. Remove the vent cover from the computer assembly.

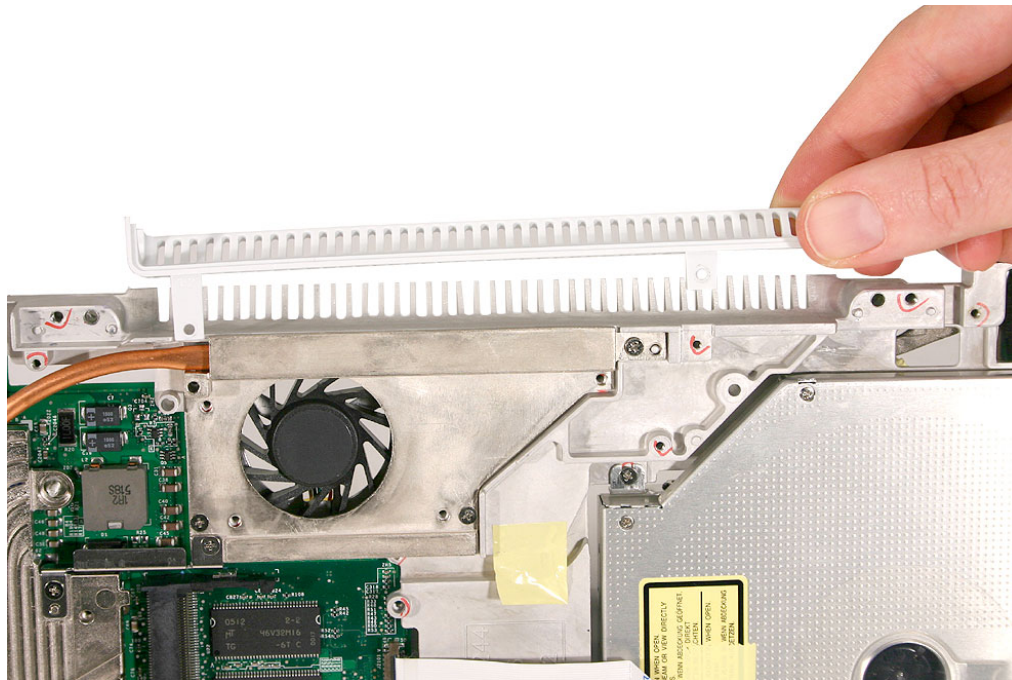

3. Install the replacement vent cover, and reassemble and test the computer.



Heatsink

Tools

- Soft cloth
- #0 Phillips screwdriver
- Black stick (or other nonconductive nylon or plastic tool)
- #4 hex nut driver or needlenose pliers

Part Location

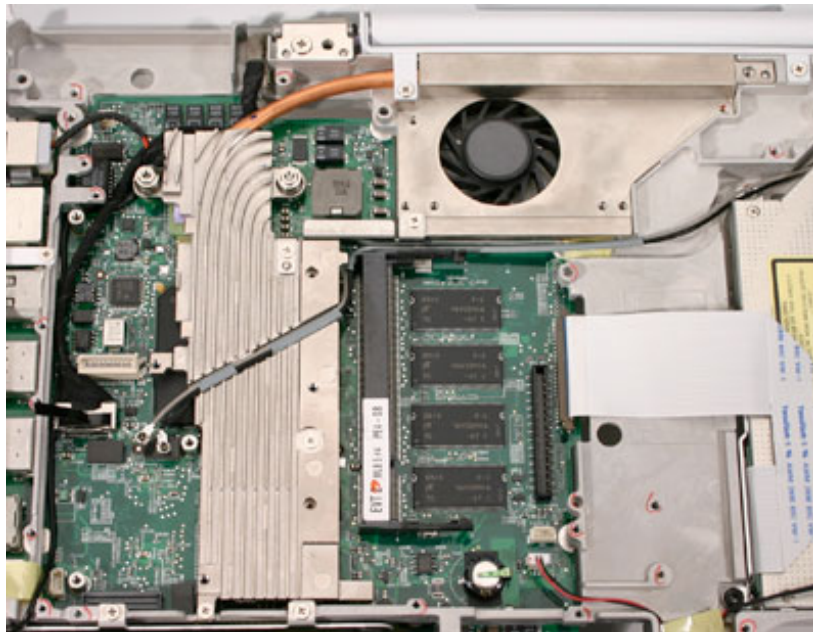

Preliminary Steps

Before you begin, remove the following:

- Battery
- Keyboard and RAM shield
- Memory card
- Bottom case
- Bottom shield

- DC-in board
- Top case
- Top shield
- Modem
- AirPort Extreme/Bluetooth card

Procedure

1. With the computer assembly on a soft cloth, remove the following from the heatsink:
 - Two 7-mm long hex nuts with captive springs
 - One 4.5-mm long Phillips screw
 - Three 3-mm long Phillips screws
 - Two 6-mm long Phillips screws

Important: When installing the two hex nuts with captive springs, install the left one half way, then install the right one completely. Finally, secure the left one completely.

Replacement Caution: When replacing the heatsink, install the hex nuts and screws in the order shown.

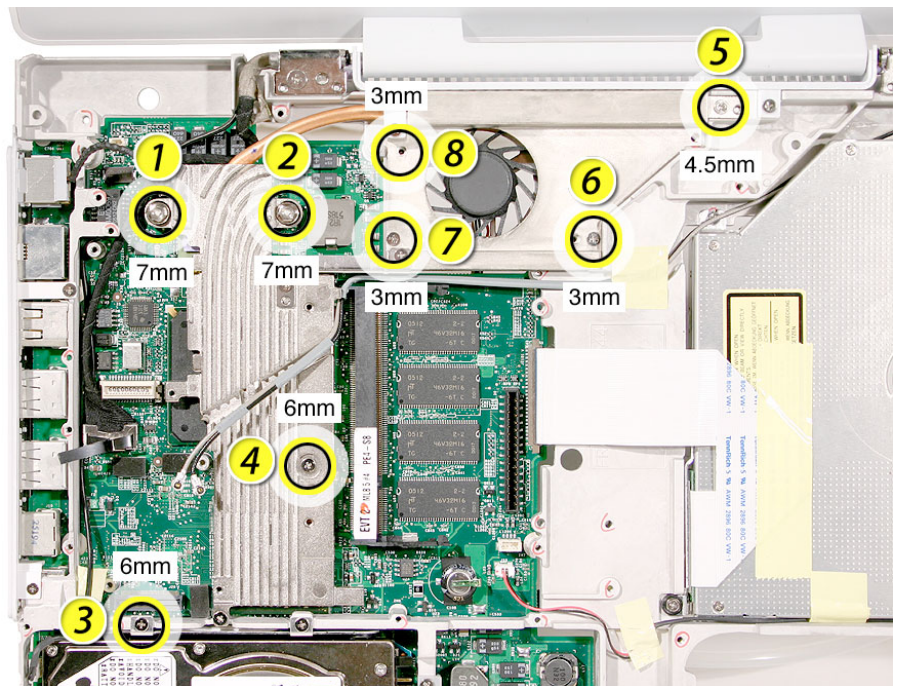

2. Remove the vent cover screws.

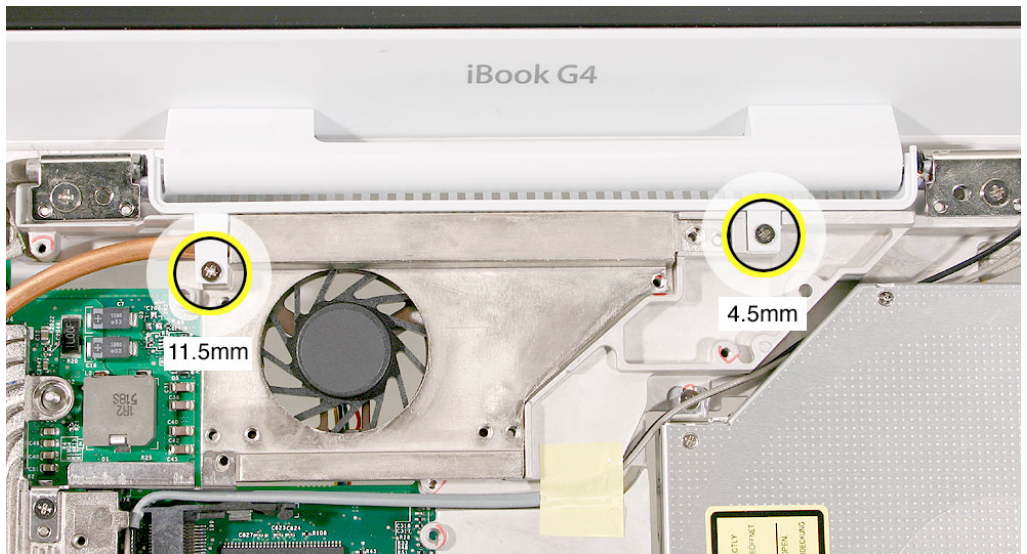

3. **Caution:** Carefully tilt up the vent cover only as far as it will go. Forcing the vent cover could crack it.

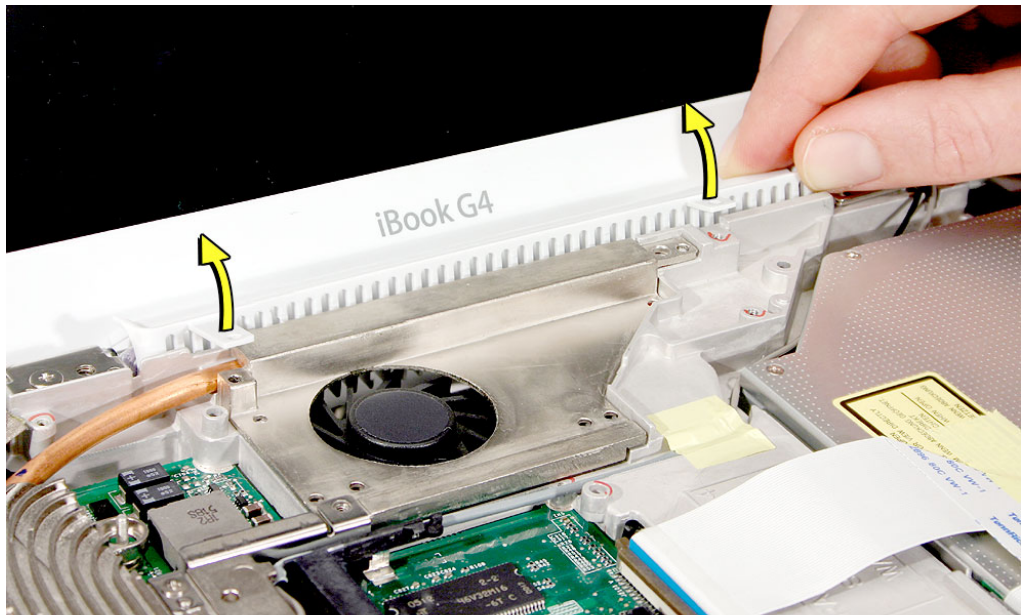

4. Before removing the heatsink, carefully pull up the AirPort Extreme/Bluetooth antenna cables from the corner of the thermal plate near the memory slot.

Caution: Skipping this step could damage the antenna cables.

5. Begin to lift up the heatsink, being careful where the copper pipe fits between the standoff and the vent cover.

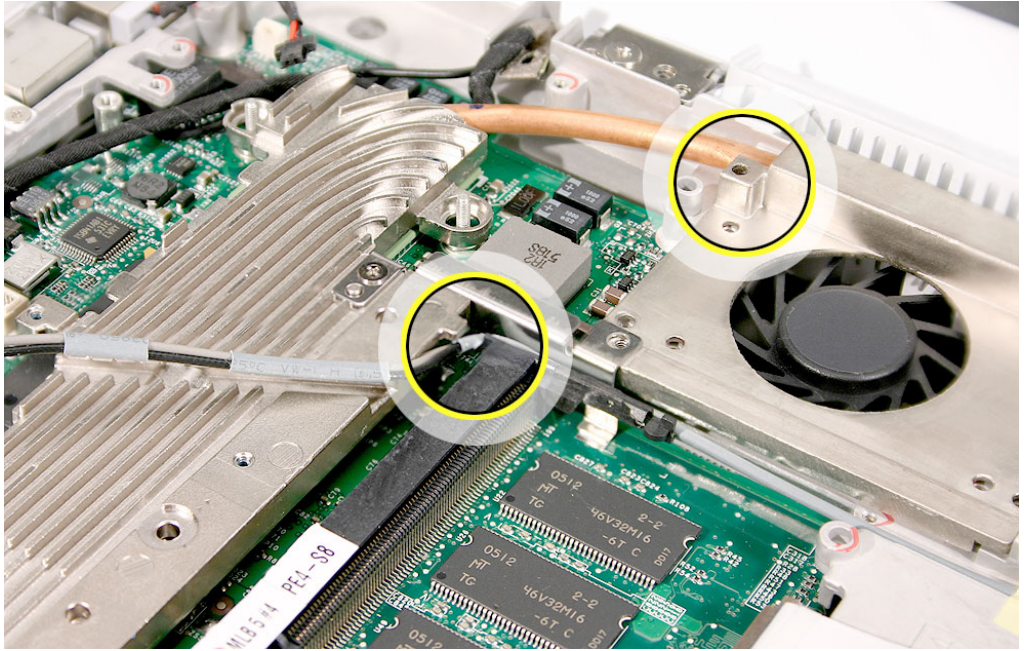

6. Use a black stick to tilt up the heatsink at the opposite corners.

Warning: The heatsink pipe can bend easily. Use caution when removing or replacing the heatsink.

Lift the heatsink out of the computer assembly.

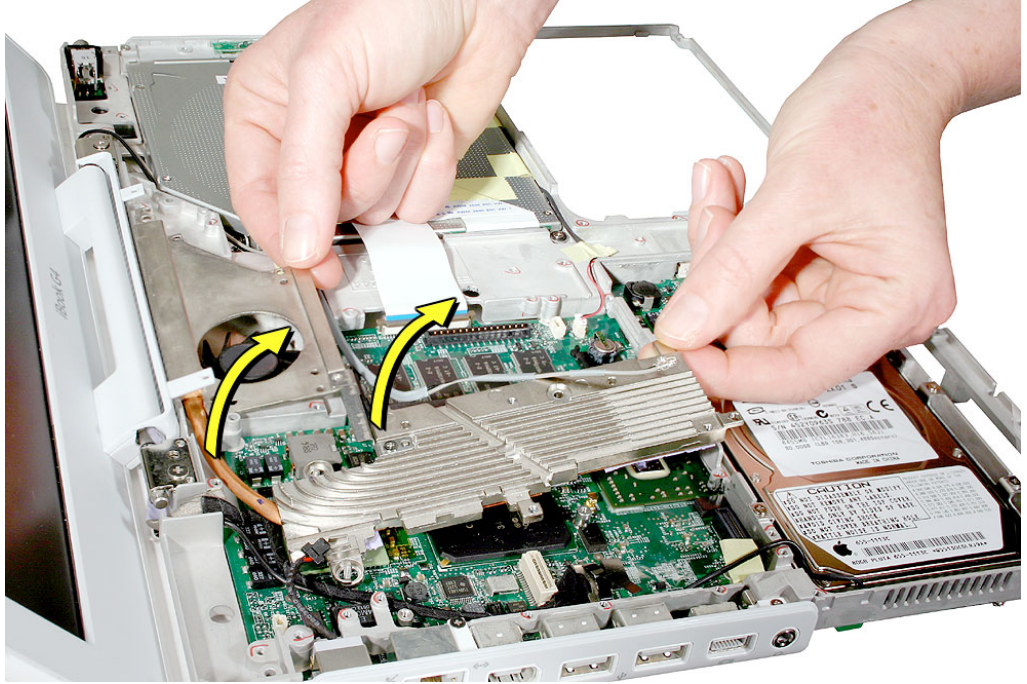

7. Turn over the heatsink and note the placement of the thermal pads.

Important: Any time the heatsink is removed or a replacement heatsink is to be installed, make sure new thermal pads are applied in the following orientation:

- Small rectangular pad at the upper end of the thermal plate
- Largest pad in the middle of the thermal plate
- Square, medium-sized pad at the lower end of the thermal plate

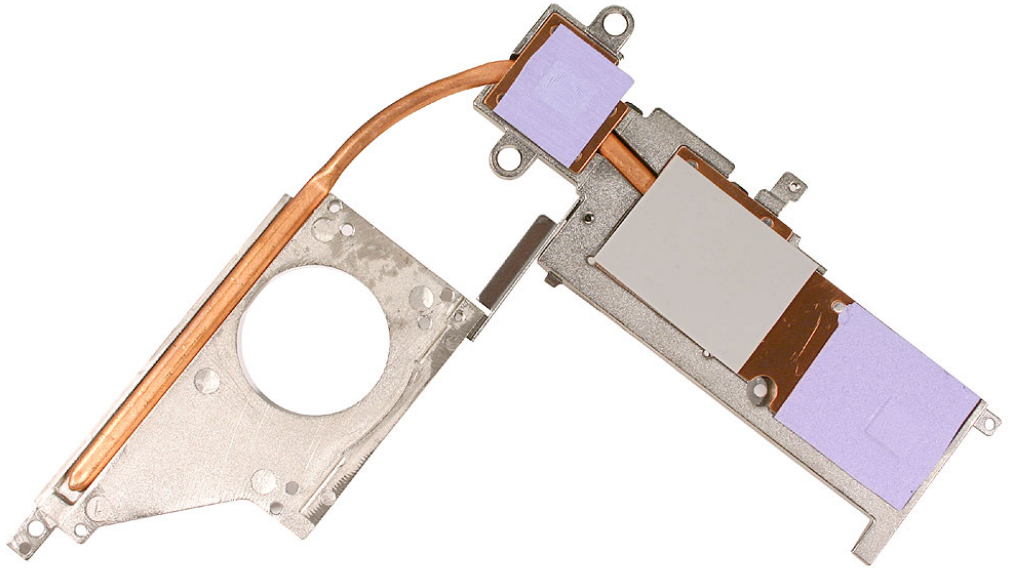

8. Before installing the heatsink, make sure it includes the thermal bridge.

Important: The thermal bridge is a bracket that connects both heatsink plates. If you are replacing the heatsink, transfer the bracket from the old heatsink to the new one.

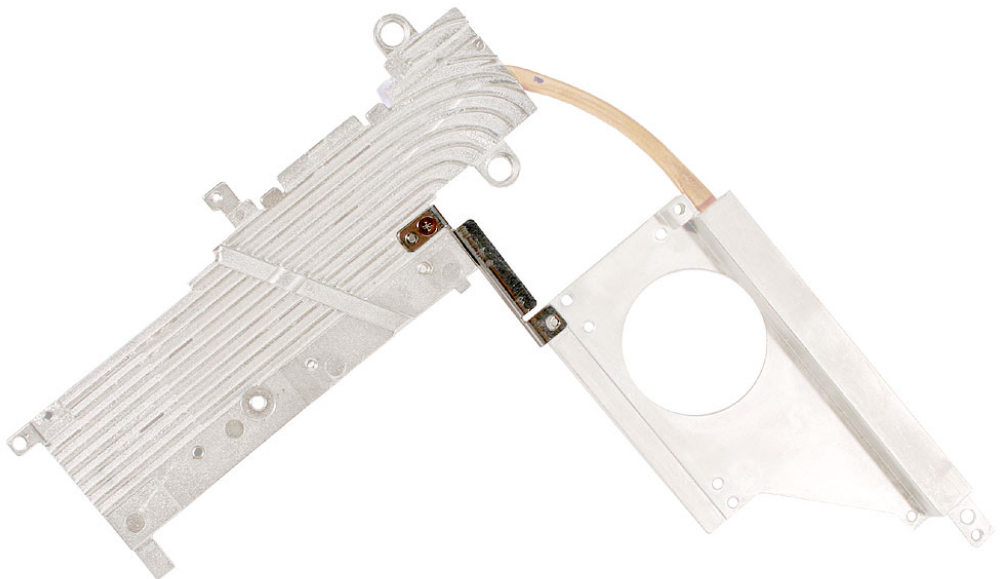

Replacement Note: Check for any thermal pad residue remaining on the logic board. If any residue remains, carefully remove it with a black stick.

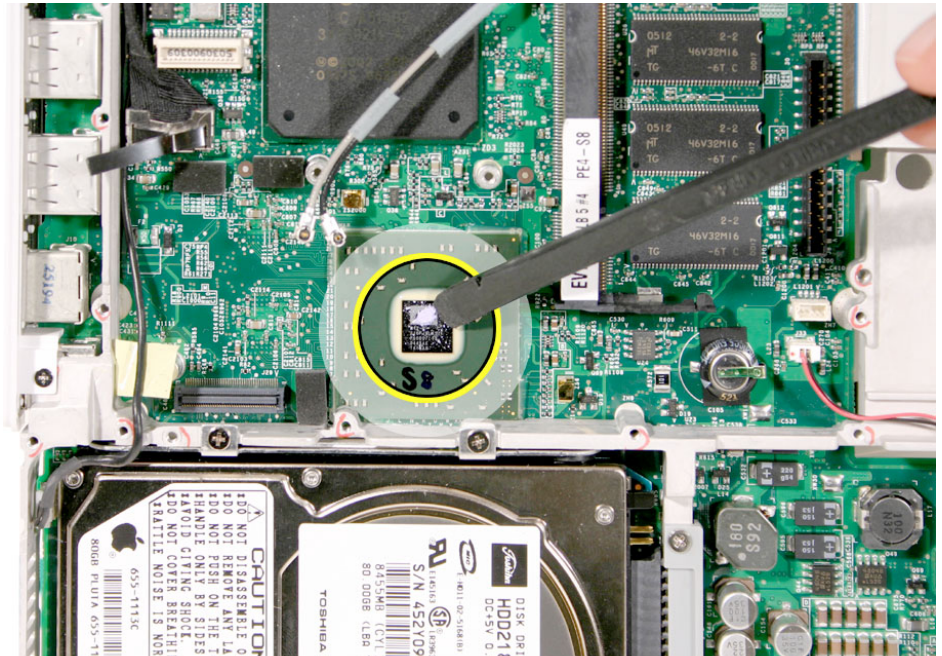

9. Install the replacement heatsink, and reassemble and test the computer.



Logic Board

Tools

- Soft cloth
- #0 Phillips screwdriver
- Black stick (or other nonconductive nylon or plastic tool)

Note: To organize the screws you remove from the computer, use a tray with divided compartments (such as a plastic ice cube tray).

Part Location

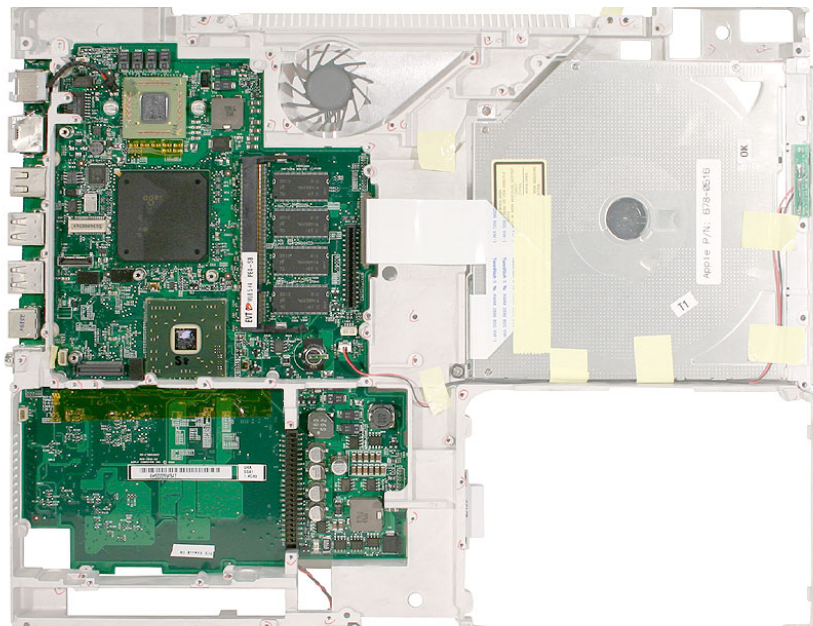

Preliminary Steps

Before you begin, remove the following:

- Battery
- Keyboard and RAM shield
- Memory card
- Bottom case

- Bottom shield
- DC-in board
- Top case
- Top shield
- I/O Bezel
- RJ11 modem cable (if installing a replacement logic board)
- Modem
- AirPort Extreme/Bluetooth card
- Heatsink

Procedure

Warning: Flexing the logic board can break solder joints to components. To prevent damage, do not flex the board.

1. With the computer on a soft cloth, disconnect the following cables:
 - optical drive cable
 - reed switch cable

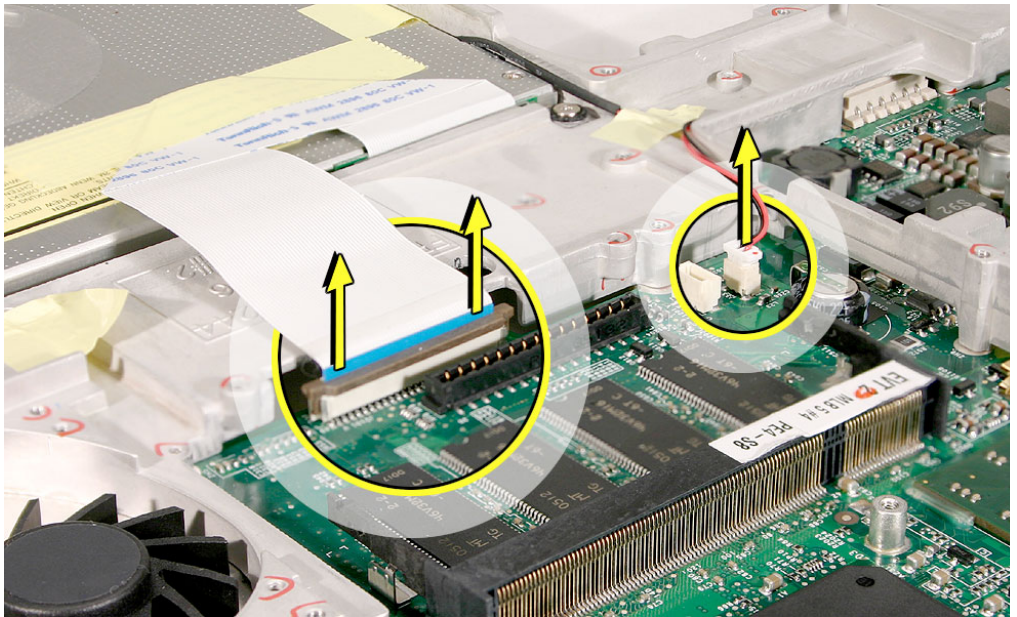

2. Turn over the frame, and peel up any tape that covers the logic board.
3. Disconnect the sleep light cable and the fan cable.

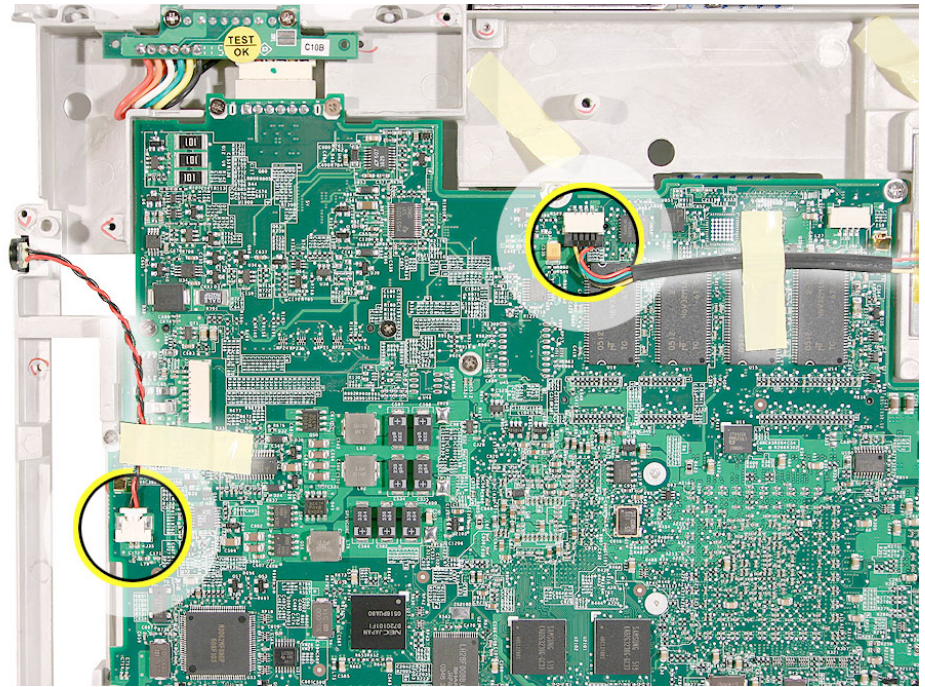

4. Turn over the frame, and remove the following from the logic board:
 - One 3.5-mm long screw
 - Eight 4.5-mm long screws
 - Two 6-mm long screws

Replacement Note: When replacing the logic board, install the screws in the order shown. The wide head 3.5-mm long screw is located at position 5.

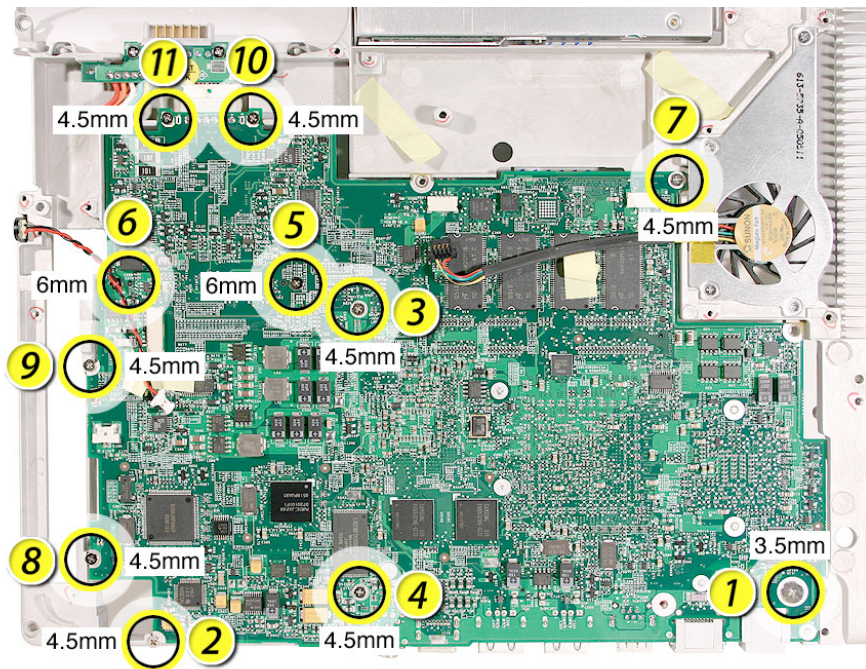

Note: When reassembling the computer, make sure that you transfer the following items from the original logic board to the top of the replacement logic board:

- Memory card
- RJ11 board

5. **Warning:** Flexing the logic board can break solder joints to components. To prevent damage, do not flex the board.

Lifting the logic board at the back ports, tilt up the logic board to remove it from the frame.

6. Disconnect the logic board from the battery transfer board connector.

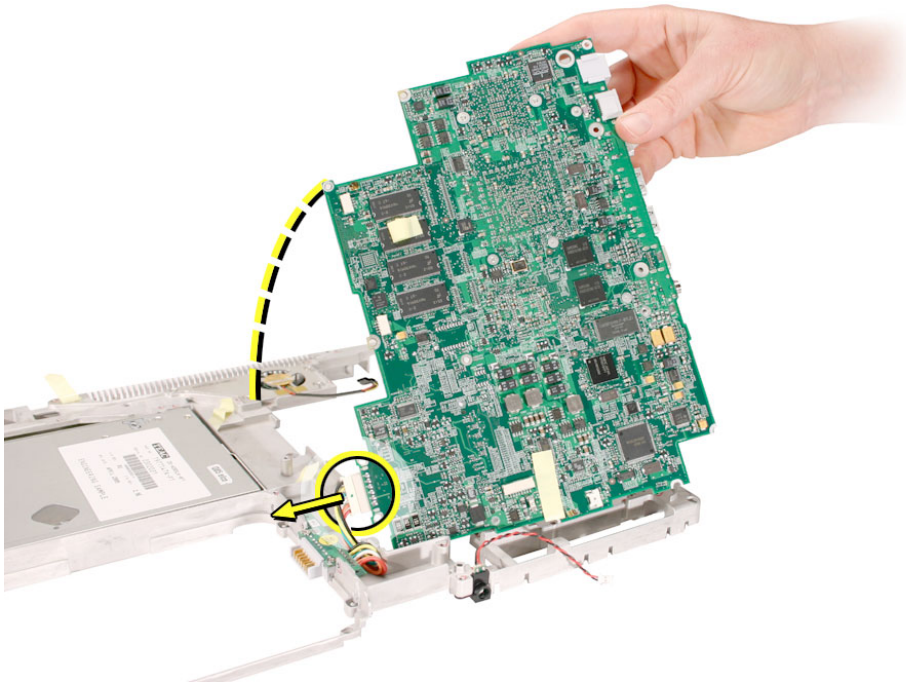

7. Install the replacement logic board, and reassemble and test the computer.

Important: Make sure the replacement logic board includes the following:

- Kapton tape where shown
- Three sponge pads, highlighted below, in the area where the AirPort Extreme/Bluetooth card is to be installed

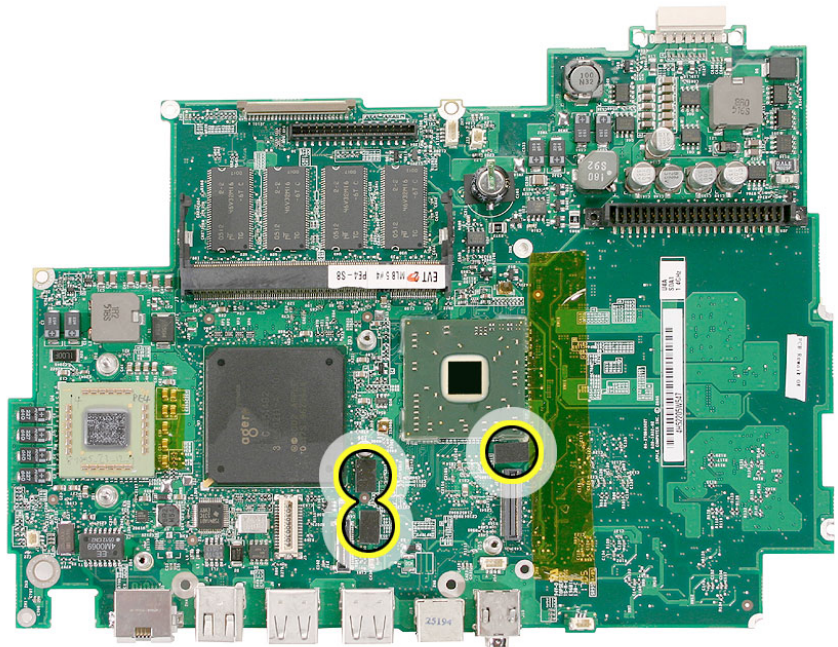
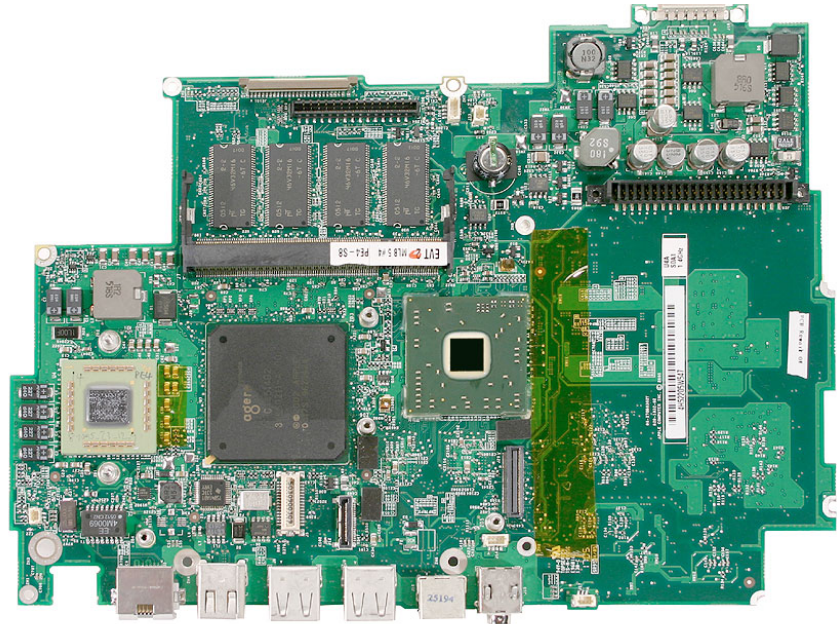

Replacement Note: Check the underside of the logic board to make sure the following cables are connected and secure:

- Sleep light cable
- Fan cable
- Battery transfer board cable

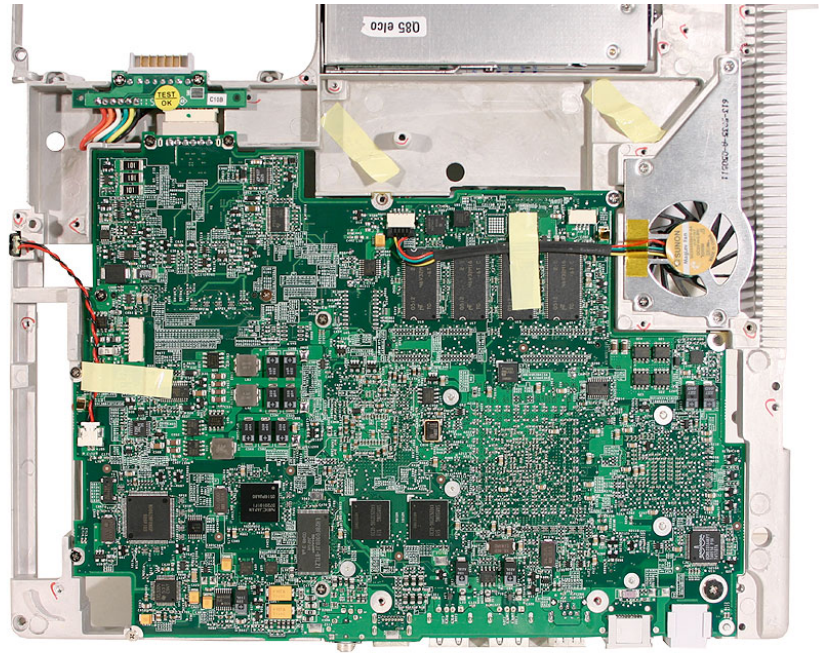



Frame

Tools

No tools are required for this procedure.

Part Location

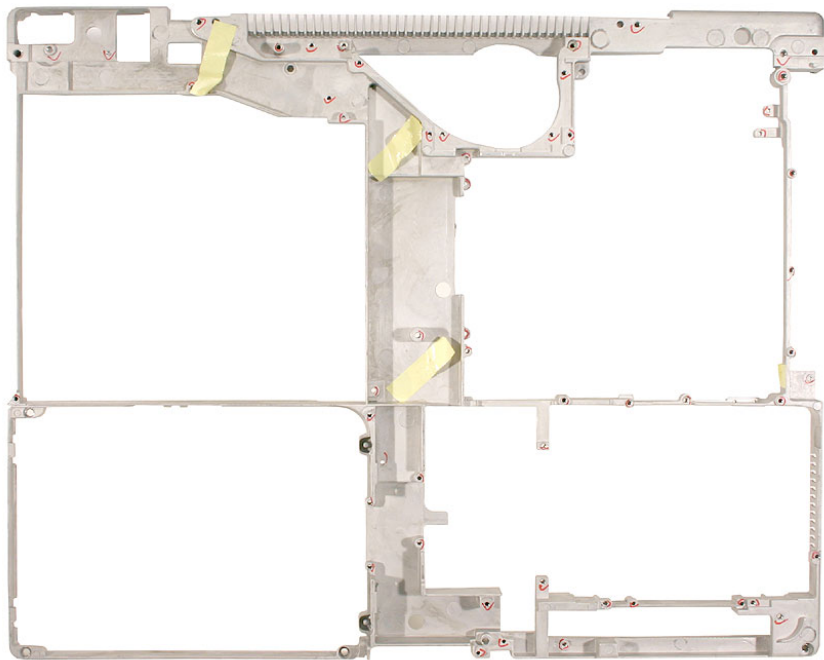

Preliminary Steps

Before you begin, remove the following:

- Battery
- Keyboard and RAM shield
- Memory card
- Bottom case
- Bottom shield
- DC-in board
- Battery transfer board

- Fan
- Top case
- Sleep light board
- Top shield
- Display module
- I/O Bezel
- RJ11 modem cable
- Hard drive
- Modem
- AirPort Extreme/Bluetooth card
- Optical drive
- Heatsink
- Vent cover
- Logic board

Procedure

With all preliminary steps completed, the frame is the remaining part.

1. Remove any remaining tape from the frame.

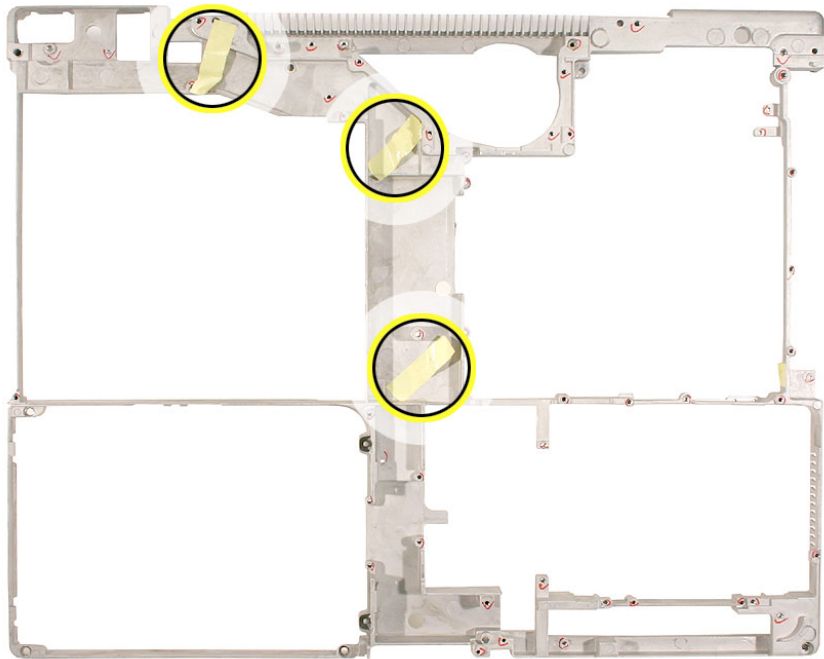

- Turn over the frame and remove the tape from the other side.

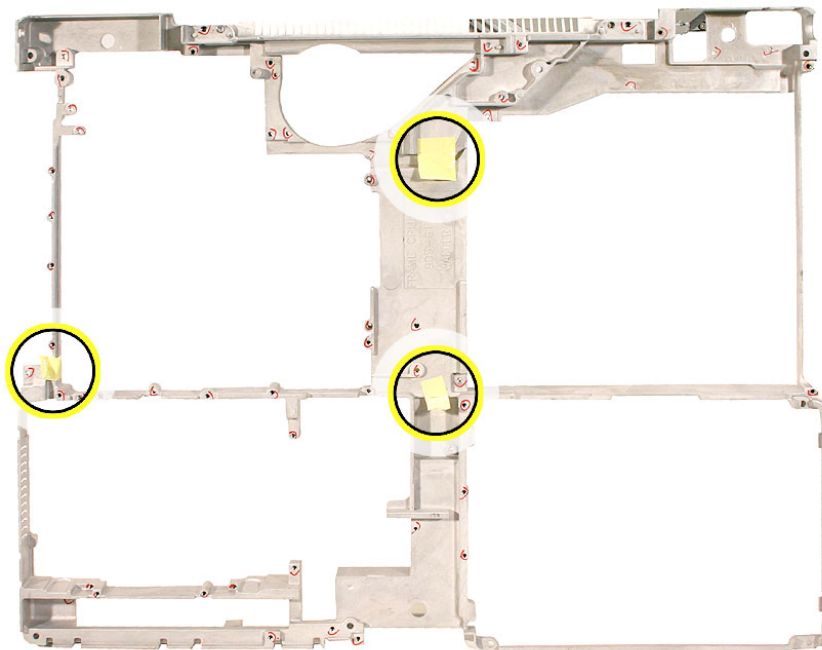

- Reassemble and test the computer.

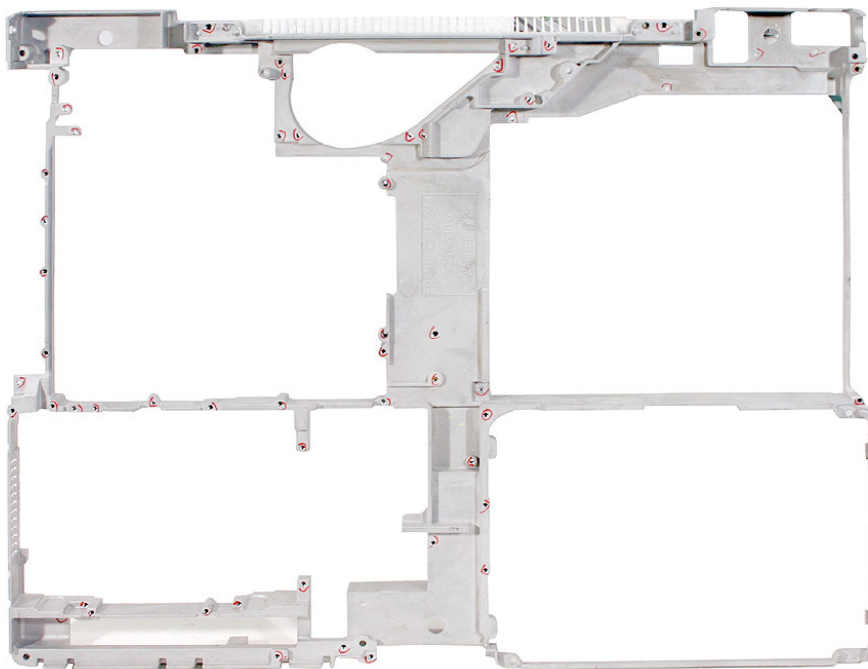



Display Rear Housing

Tools

- Soft cloth
- Torx T6 screwdriver or 5/32 hex driver
- Black stick (or other nonconductive nylon or plastic tool)

Note: To organize the screws you remove from the display assembly, use a tray with divided compartments (such as a plastic ice cube tray).

Replacement Note: If the tape you remove from this assembly is worn and cannot be reused, use new Kapton tape (Apple part number 922-5025).

Part Location



Preliminary Steps

Before you begin, remove the following:

- Battery
- Keyboard and RAM shield
- Memory card
- Bottom case
- Bottom shield
- DC-in board
- Top case
- Top shield
- Modem
- AirPort Extreme/Bluetooth card
- Display module

Procedure

1. With the display face down on a soft cloth, remove the four 7-mm long hex screws (two from each side) from the display module.



2. Starting at a corner of the display, use a black stick to pry up the bezel from the display housing. Carefully work the black stick around the outer perimeter and corners of the bezel.



3. Lift off the display assembly from the display housing.



-
4. Install the replacement display rear housing, and reassemble and test the computer.

Replacement Note: Make sure the replacement housing is clean and free of dust. Make sure that no cables can be pinched as you place the LCD panel assembly into the housing. Verify that the screw holes are aligned before installing the screws.





Display Clutch Cover

Tools

- Soft cloth
- #0 Phillips screwdriver
- Black stick (or other nonconductive nylon or plastic tool)

Note: To organize the screws you remove from the display assembly, use a tray with divided compartments (such as a plastic ice cube tray).

Part Location



Preliminary Steps

Before you begin, remove the following:

- Battery
- Keyboard and RAM shield
- Memory card
- Bottom case
- Bottom shield
- DC-in board
- Top case
- Top shield
- Modem
- AirPort Extreme/Bluetooth card
- Display module
- Display rear housing

Procedure

1. Note the placement of tape on the display shield.



2. Peel up the long strip of white tape where it covers the clutch cover screw on the right.

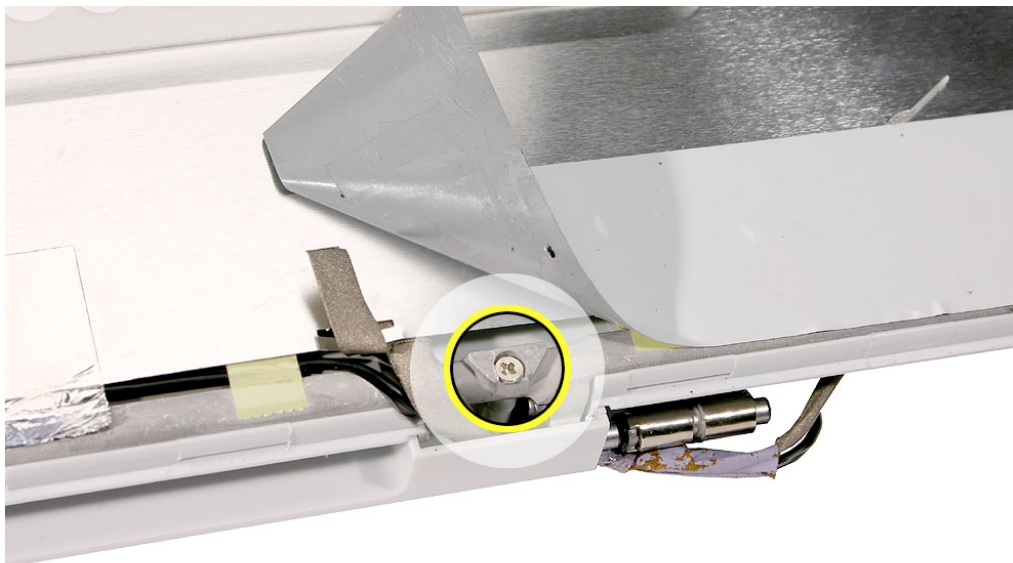

3. Near the right and left sides of the clutch, remove the two 12-mm long screws that secure the clutch cover to the hinge assembly.

Replacement Note: Note that one of the screws (left side of the clutch when the display is oriented as shown) also has a washer. Be sure to reinstall it before installing the clutch cover screw.

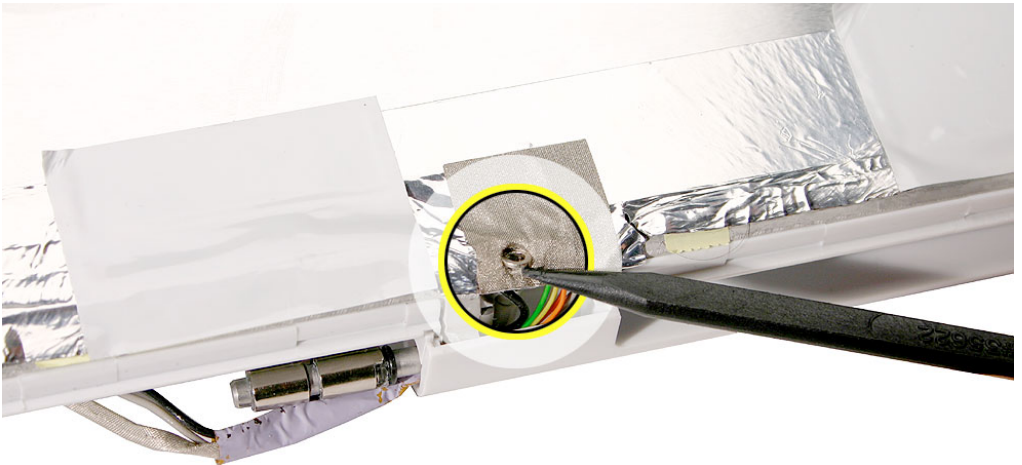
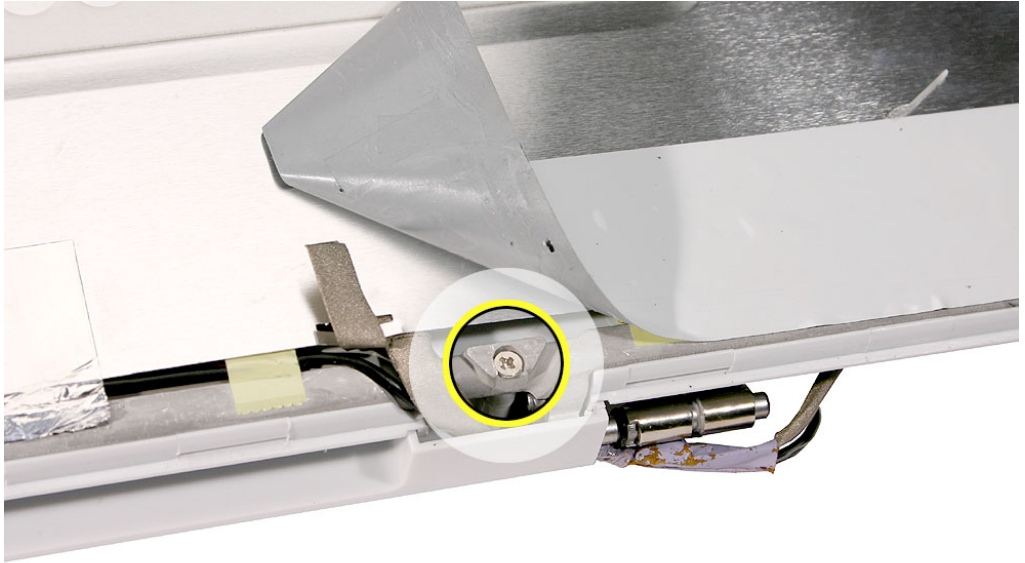

4. Tilt up the display assembly and pull straight down on the display clutch cover to remove the clutch cover from the display assembly.

Note: There are two thin, small, plastic clutch caps that fit into the ends of the clutch cover. The clutch caps might fall off as you remove the clutch cover. Be careful not to lose the clutch caps.

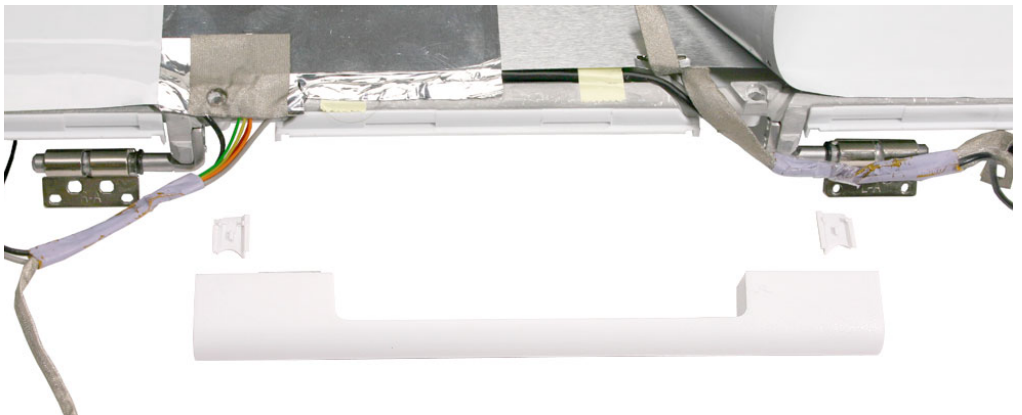

5. Note the proper placement of the left and right clutch caps. The caps are unique for each side and are not interchangeable. A molded marking on the inner side of the clutch caps helps identify their intended location in the display assembly. For instance,
 - A marking of "R1" indicates it is the right clutch cap (right side of clutch when display is viewed from the front).
 - A marking of "L2" indicates it is the left clutch cap (left side of clutch when display is viewed from the front).

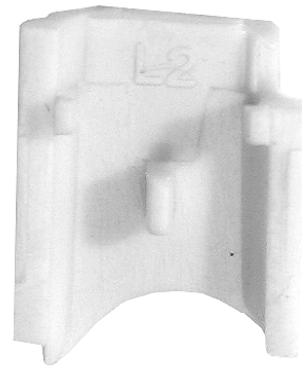
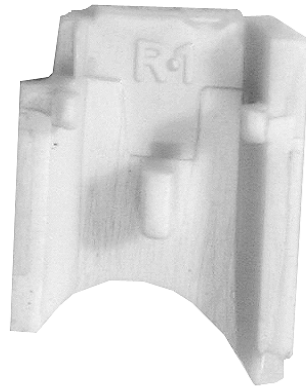
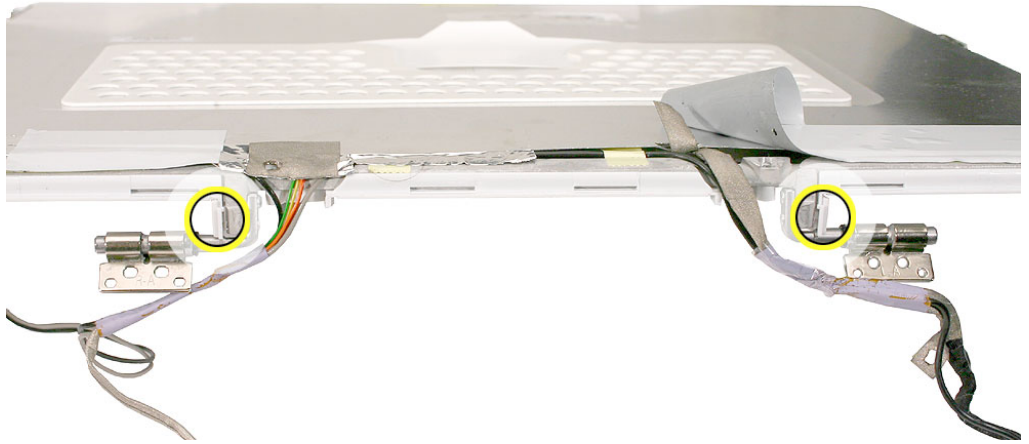

6. Install the replacement display clutch cover, and reassemble and test the computer.

Warning: When installing the replacement clutch cover, be careful not to strain or pinch the cables. Make sure they fit easily into the recessed area on both ends of the clutch cover.

Note: The bundled cables on your display might look somewhat different than shown here.



Replacement Note: When installing the replacement clutch cover, hold the cables and clutch caps in place as you slide the clutch cover over them.





Display Shield

Tools

- Soft cloth
- #0 Phillips screwdriver
- Black stick (or other nonconductive nylon or plastic tool)

Note: To organize the screws you remove from the display assembly, use a tray with divided compartments (such as a plastic ice cube tray).

Replacement Note: If the tape you remove from this assembly is worn and cannot be reused, use new Kapton tape (Apple part number 922-5025).

Part Location

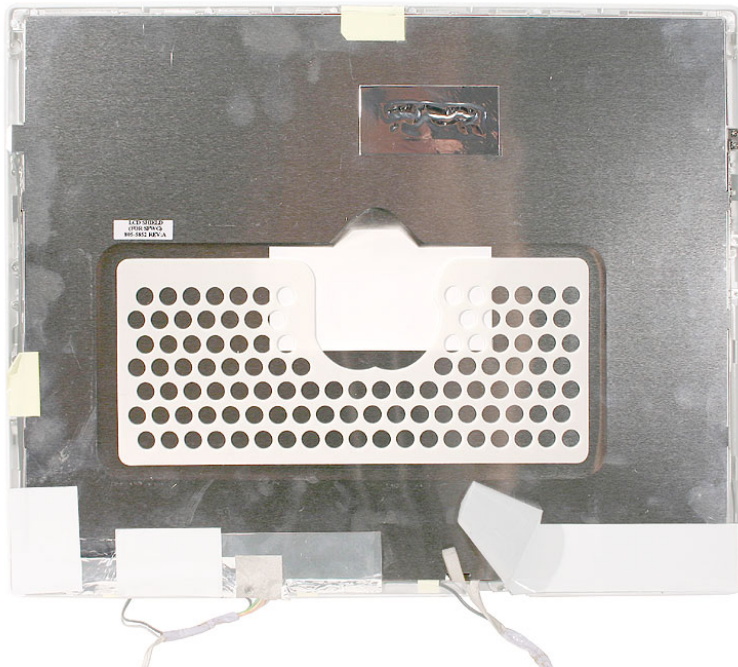

Preliminary Steps

Before you begin, remove the following:

- Battery
- Keyboard and RAM shield
- Memory card
- Bottom case
- Bottom shield
- DC-in board
- Top case
- Top shield
- Modem
- AirPort Extreme/Bluetooth card
- Display module
- Display rear housing
- Display clutch cover (and clutch caps)

Procedure

1. Note the placement of tape on the shield.

Replacement Note: When reassembling the display, re-use or apply new tape in the places shown.

2. Peel up or the tape that secures the shield to the LCD panel.



3. Notice the U-shaped notches on the sides of the bezel.
4. Remove the four 3.5-mm long Phillips screws (two on each side) from the display shield. (Move aside any cables or tape that partially block access to the screws.)

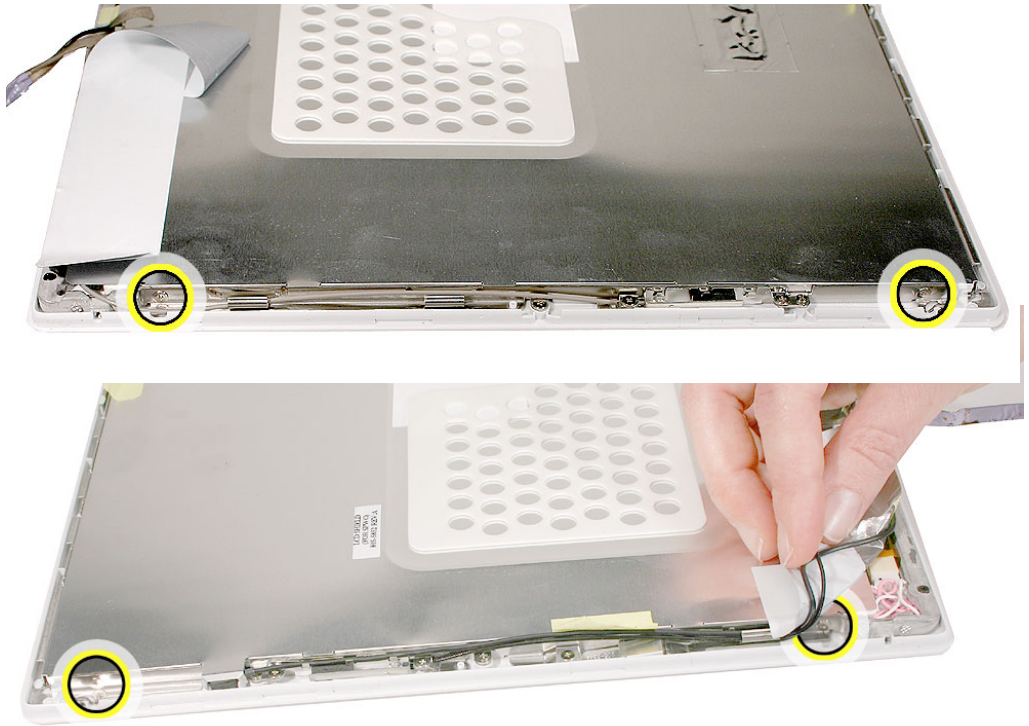

5. Peel up the foil tape that holds the LVDS cable to the LCD panel.
6. Peel up the tape that anchors the folded mesh strip of the LCD cable to the shield.

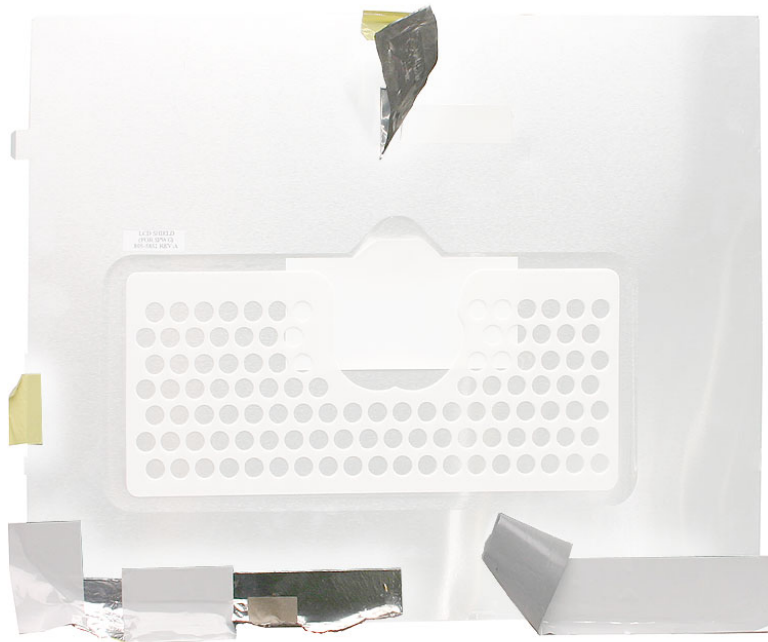

7. Peel up the tape at the top of the shield.
8. Lift up the shield, being careful not to bend it.

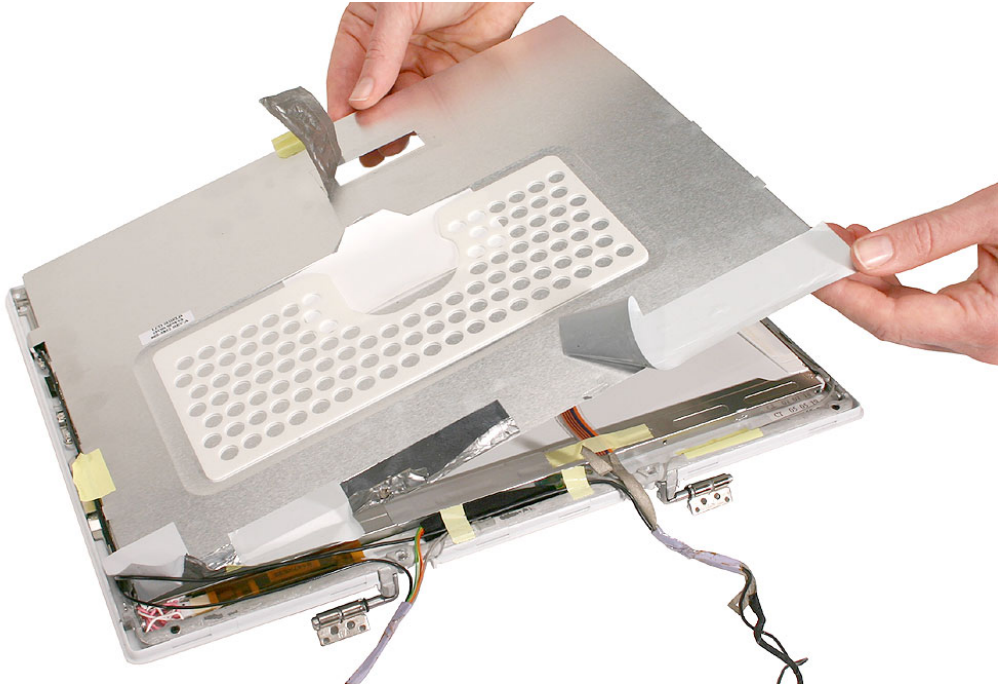

9. Install the replacement display shield, and reassemble and test the computer.

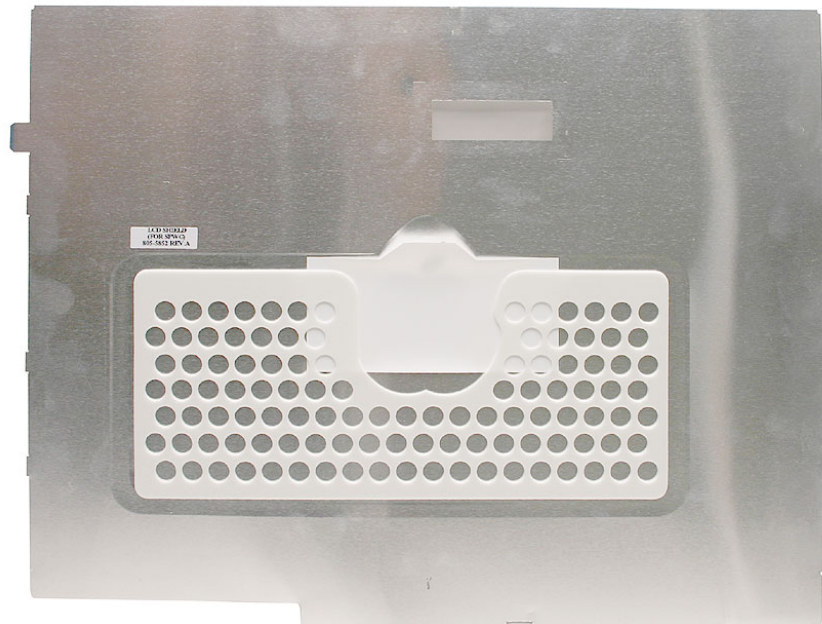



LCD Panel

Tools

- Soft cloth
- Black stick (or other nonconductive nylon or plastic tool)

Part Location



Preliminary Steps

Before you begin, remove the following:

- Battery
- Keyboard and RAM shield
- Memory card
- Bottom case
- Bottom shield
- DC-in board

- Top case
- Top shield
- Modem
- AirPort Extreme/Bluetooth card
- Display module
- Display rear housing
- Display clutch cover
- Display shield

Procedure

Important: Although the display pictured in this section may appear different from the display you are working on, the steps are the same.

1. Place the display assembly face down on a soft cloth.
2. On the back of the LCD panel, grasp both sides of the LVDS connector, and gently rock and pull the connector to disconnect the LVDS cable from the LCD panel.



3. At the other end of the LVDS cable, remove the tape from the bottom edge of the LCD panel.

Important: Note that the mesh tab near the middle of the LVDS cable is not covered by the tape. Rather, it lays flat when taped over the LCD shield.

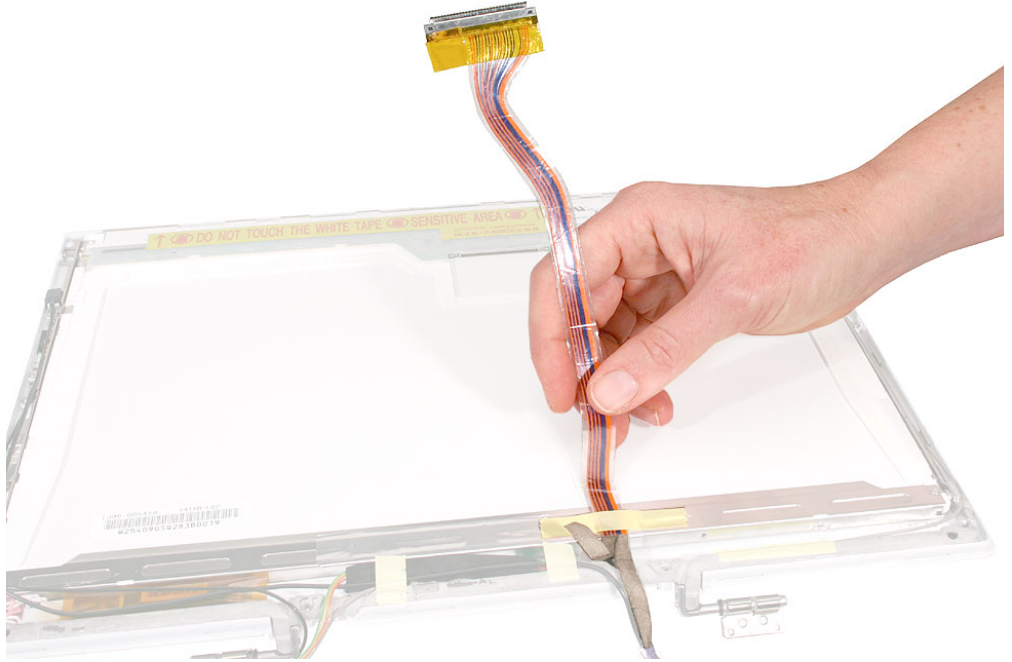

4. **Warning: When lifting the LCD panel, be careful not to strain the inverter cable.**
Carefully lift up the LCD panel, pivoting it where it is still connected to the inverter by the 2-pin LCD connector.
5. Disconnect the 2-pin LCD cable from the inverter board, and remove the LCD panel.

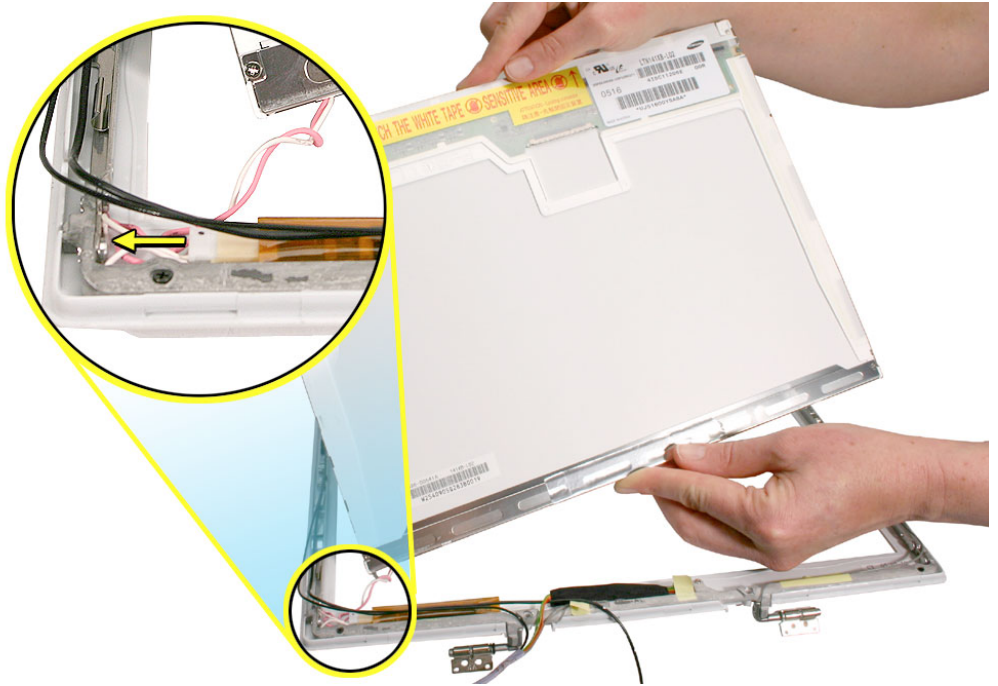

6. Install the replacement LCD panel, and reassemble and test the computer.

Replacement Note: When servicing the display, you may encounter more than one version of the LCD panel. The replacement instructions, however, are the same for all versions of the display.





Microphone Cable

Tools

- Soft cloth
- Black stick (or other nonconductive nylon or plastic tool)

Note: To organize the screws you remove from the display assembly, use a tray with divided compartments (such as a plastic ice cube tray).

Part Location

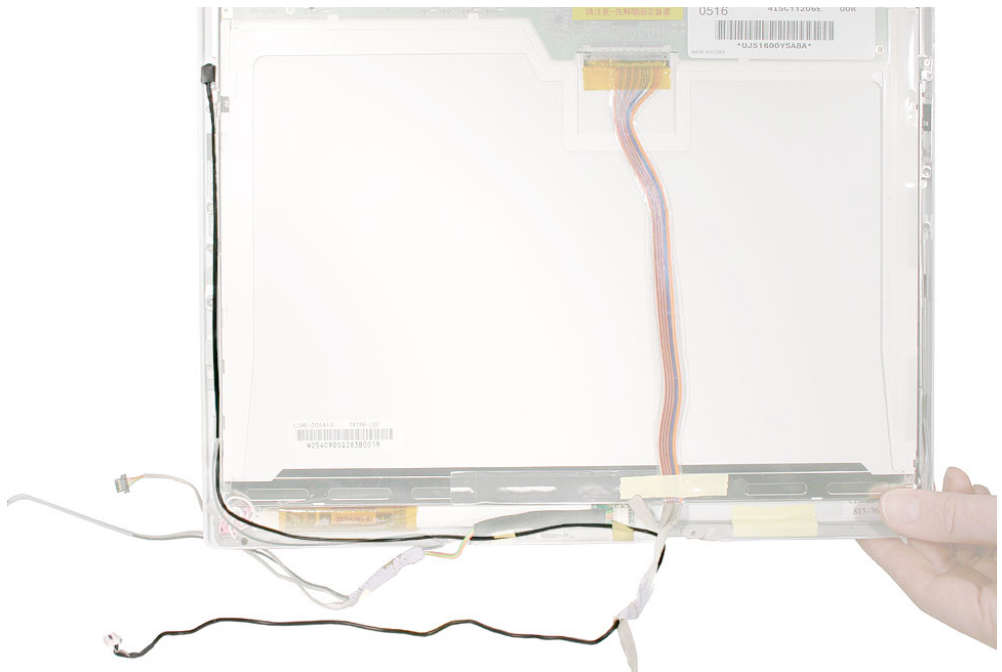

Preliminary Steps

Before you begin, remove the following:

- Battery
- Keyboard and RAM shield
- Memory card
- Bottom case

- Bottom shield
- DC-in board
- Top case
- Top shield
- Modem
- AirPort Extreme/Bluetooth card
- Display module
- Display rear housing
- Display clutch cover
- Display shield

Procedure

1. Remove the tape from the microphone cable where it exits the bezel on the lower right edge of the bezel brace.

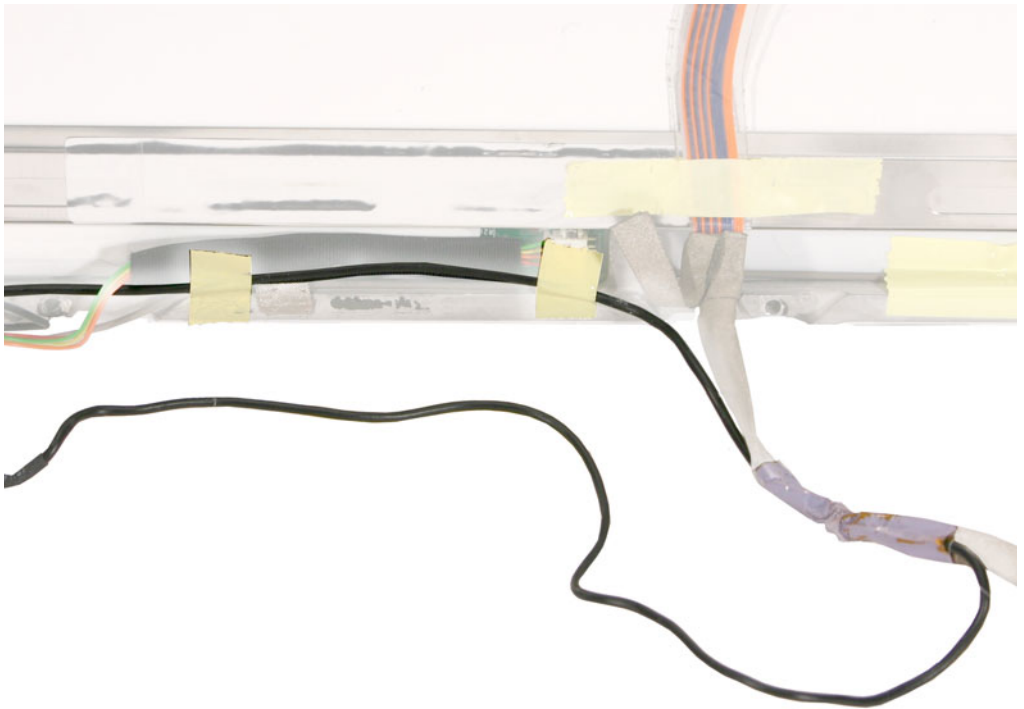

2. Thread the loose end of the microphone cable between the gray antenna cable and the inverter cable.

Note: Note that the black microphone cable is thicker than the black antenna cable.

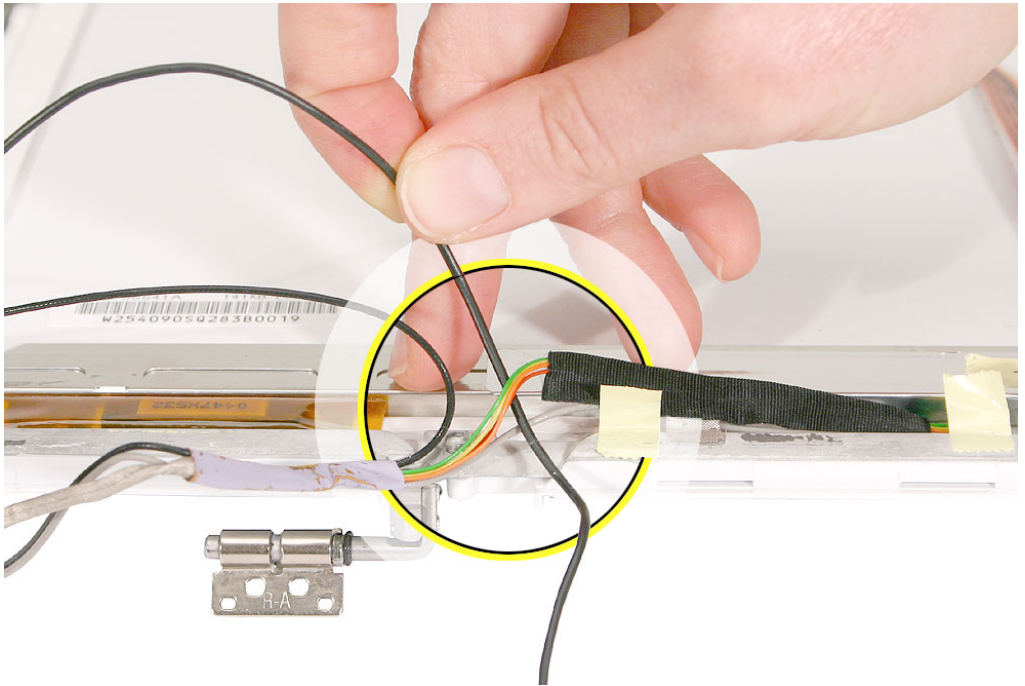

3. Pivot the left side of the display assembly toward you, and guide the microphone cable out of the tabs that hold it along the left side of the bezel.



4. Use a black stick to pry up the microphone from its holder.

Replacement Note: When installing the replacement microphone, note that the square padded side of the microphone faces up.

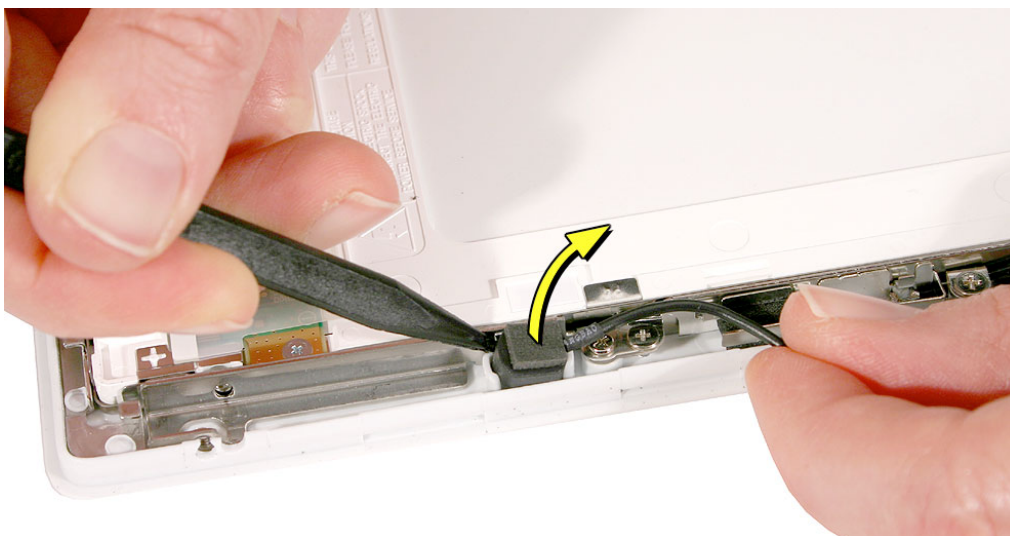

5. Before reinstalling the microphone cable, ensure that the rectangular, black pad is adhered to the back of the microphone.

Important: If you are installing a replacement microphone cable, peel up the black pad from the original microphone, and stick it on the new microphone.



-
6. Install the replacement microphone cable, and reassemble and test the computer.
- Important:** Make sure it is positioned with the black pad up before installing it in the recessed area of the bezel brace.

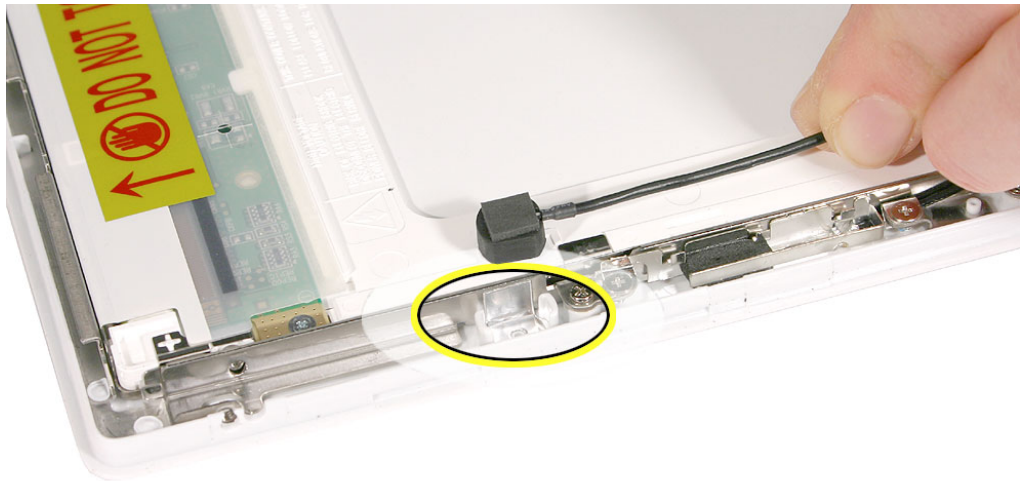



LVDS Cable

Tools

- Soft cloth
- Black stick (or other nonconductive nylon or plastic tool)

Part Location

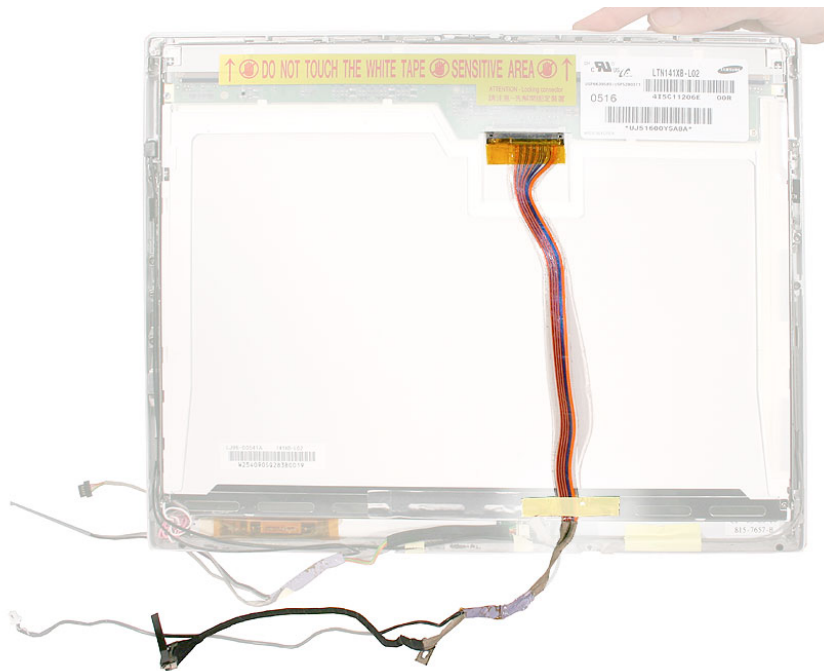

Preliminary Steps

Before you begin, remove the following:

- Battery
- Keyboard and RAM shield
- Memory card
- Bottom case
- Bottom shield
- DC-in board

- Top case
- Top shield
- Modem
- AirPort Extreme/Bluetooth card
- Display module
- Display rear housing
- Display clutch cover
- Display shield

Procedure

1. On the back of the LCD panel, grasp both sides of the LVDS connector, and gently rock and pull the connector to disconnect the LVDS cable from the LCD panel.



2. Near the middle of the LVDS cable, peel the tape from the LVDS cable, and free it from the microphone cable.

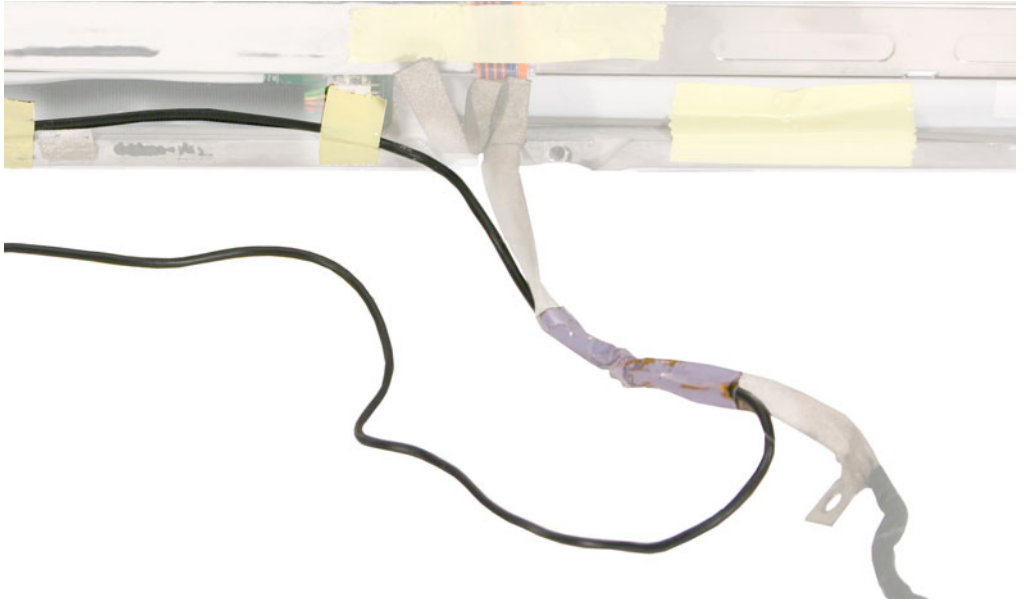

3. Remove the tape from the bottom edge of the LCD panel.

Important: Note that the mesh tab is not covered by the tape. Rather, it lays flat when taped over the LCD shield.

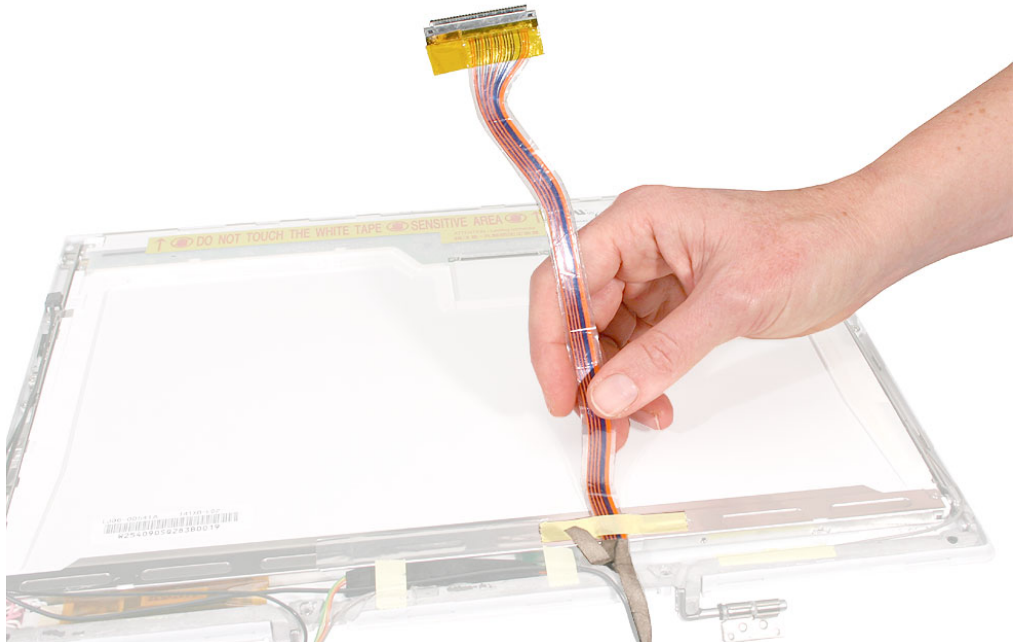

-
4. Remove the LVDS cable from the bezel assembly.

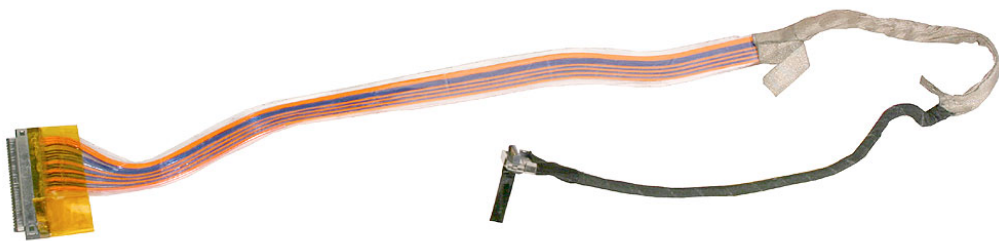

5. Install the replacement LVDS cable, and reassemble and test the computer.



AirPort Extreme/Bluetooth Antenna Cables

Tools

- Soft cloth
- #0 Phillips screwdriver
- Black stick (or other nonconductive nylon or plastic tool)

Note: To organize the screws you remove from the display assembly, use a tray with divided compartments (such as a plastic ice cube tray).

Part Location

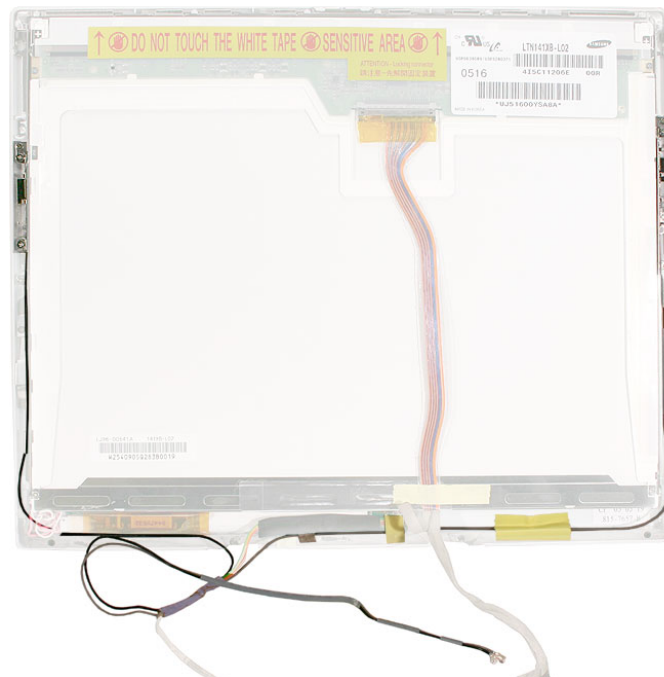

Preliminary Steps

Before you begin, remove the following:

- Battery

- Keyboard and RAM shield
- Memory card
- Bottom case
- Bottom shield
- DC-in board
- Top case
- Top shield
- Modem
- AirPort Extreme/Bluetooth card
- Display module
- Display rear housing
- Display clutch cover
- Display shield
- Display LCD panel
- Microphone cable

Procedure

1. From the bottom of the bezel brace, note the routing of the black and gray antenna cables.

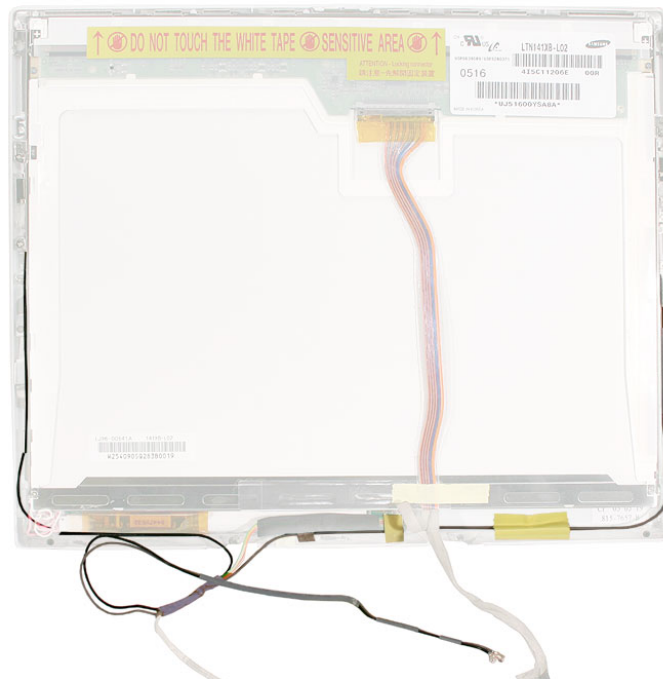

2. Peel away the tape that bundles the antenna cables to the inverter cable. Remove the antenna cables from the tape.

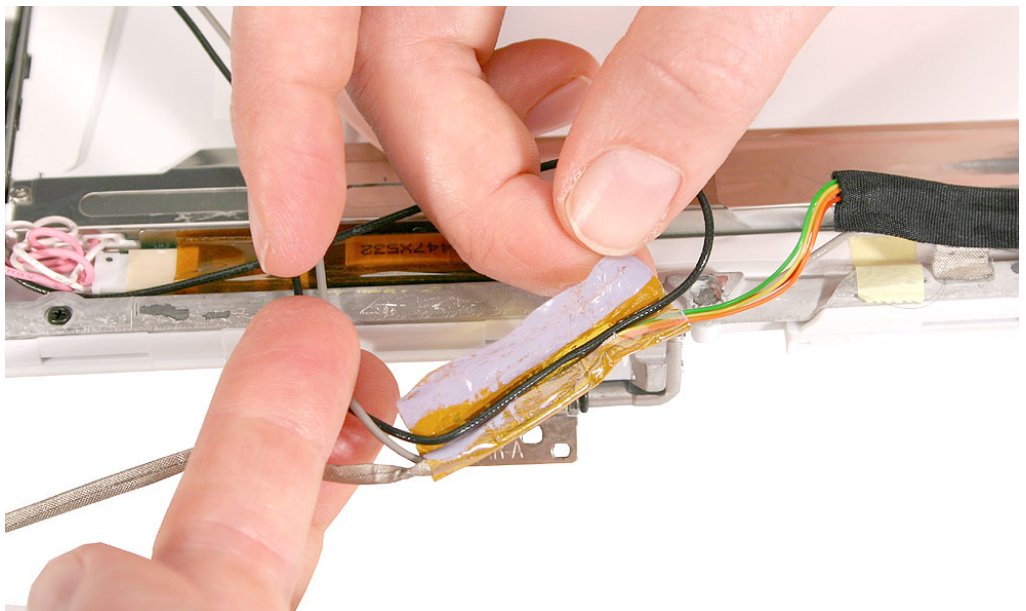
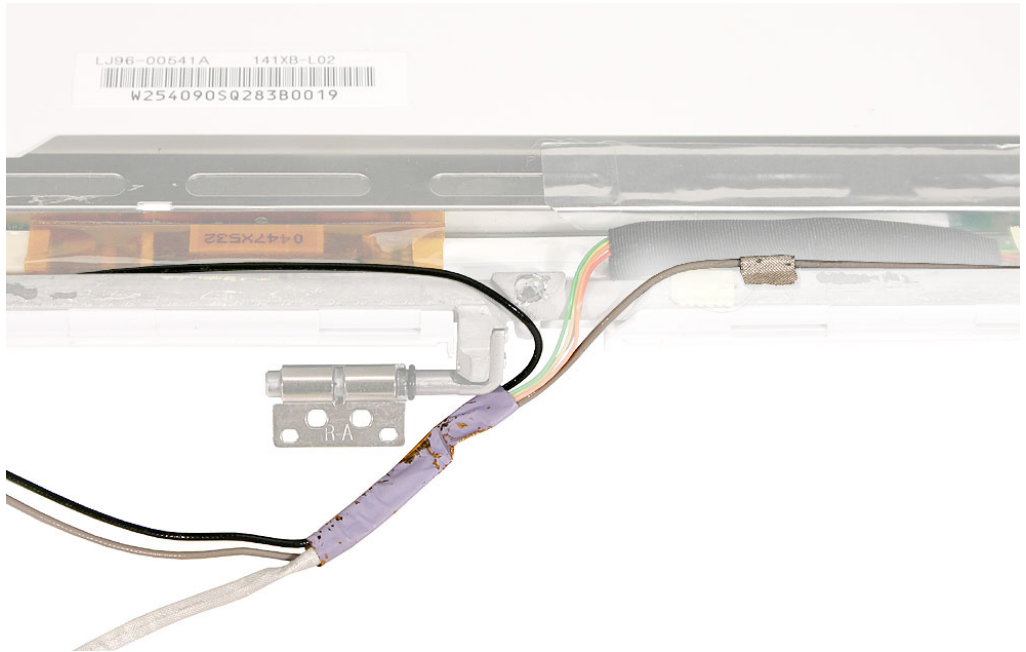

3. Carefully lift up the black antenna cable from the guides along the left corner and left side of the bezel brace. Do not strain any cables.



4. Remove the two 3-mm long screws that secure the antenna receptor—with black cable attached.

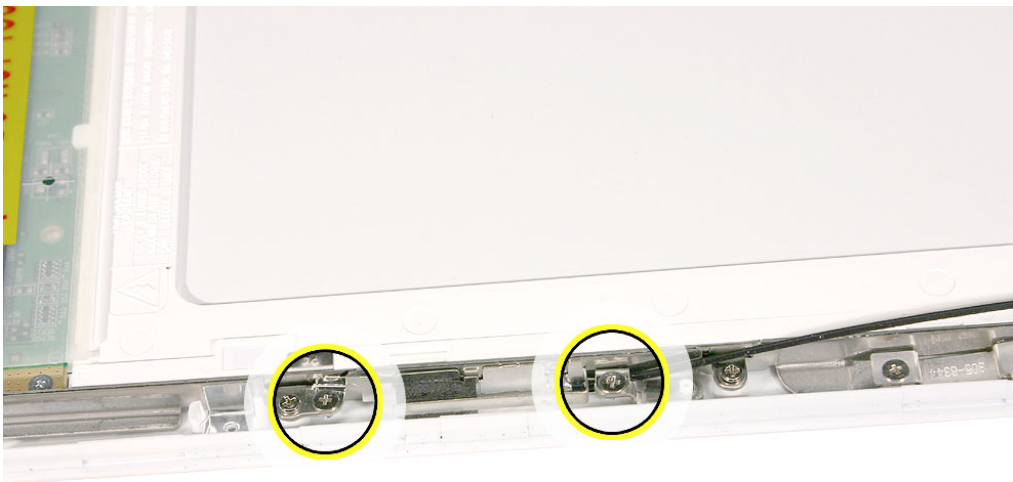

5. From the left side of the bezel, slide the antenna receptor toward the top of the bezel to release it from the bezel assembly.

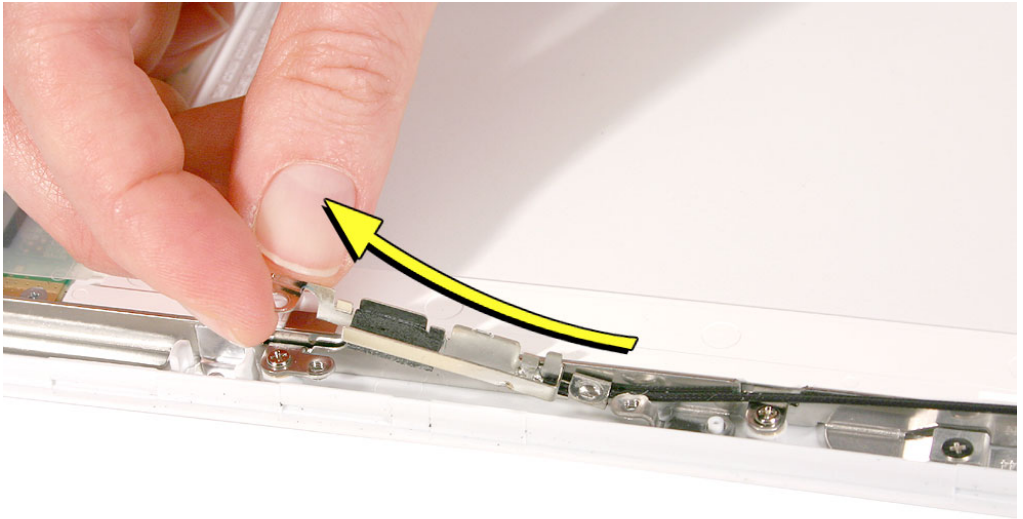

6. From the bottom of the bezel, lift up the inverter cable where the mesh tab anchors the gray antenna cable between the bezel brace and the inverter board.

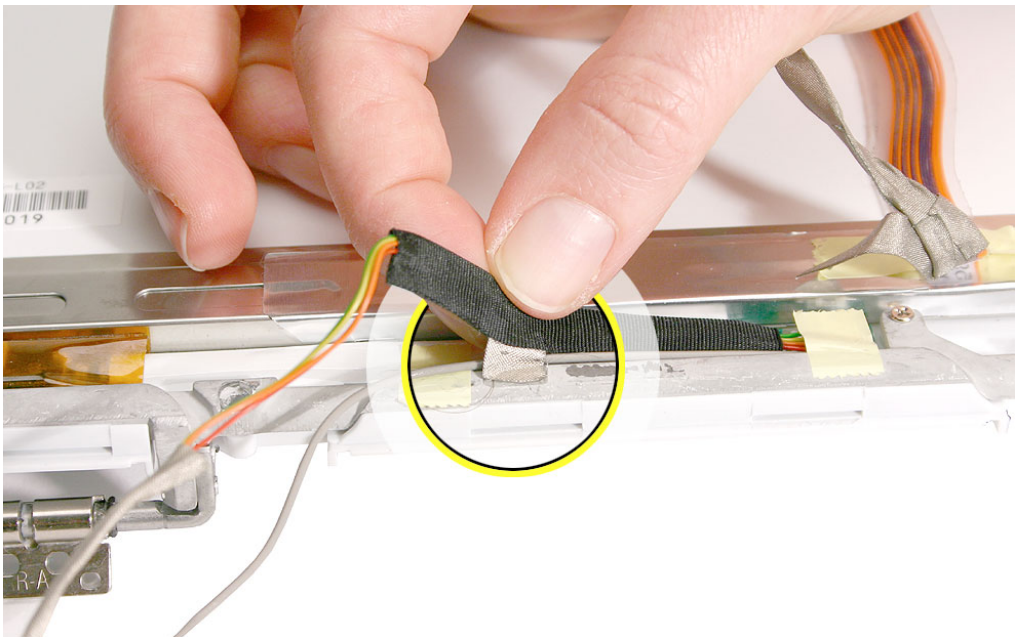

7. Note how the gray cable is routed along the bottom of the inverter board, under the bezel brace, and around the corner by the corner tab.
8. Remove the two strips of tape and the 4.5-mm long screw from the bottom of the bezel brace.

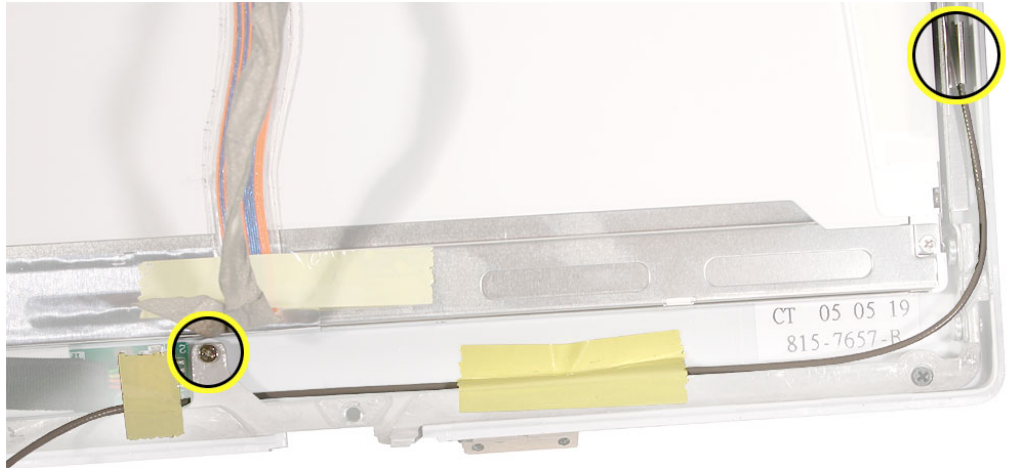

9. To route the cable under the screw tab, press down on the bezel as you raise up the bezel brace. Then slip the gray cable under the tab.

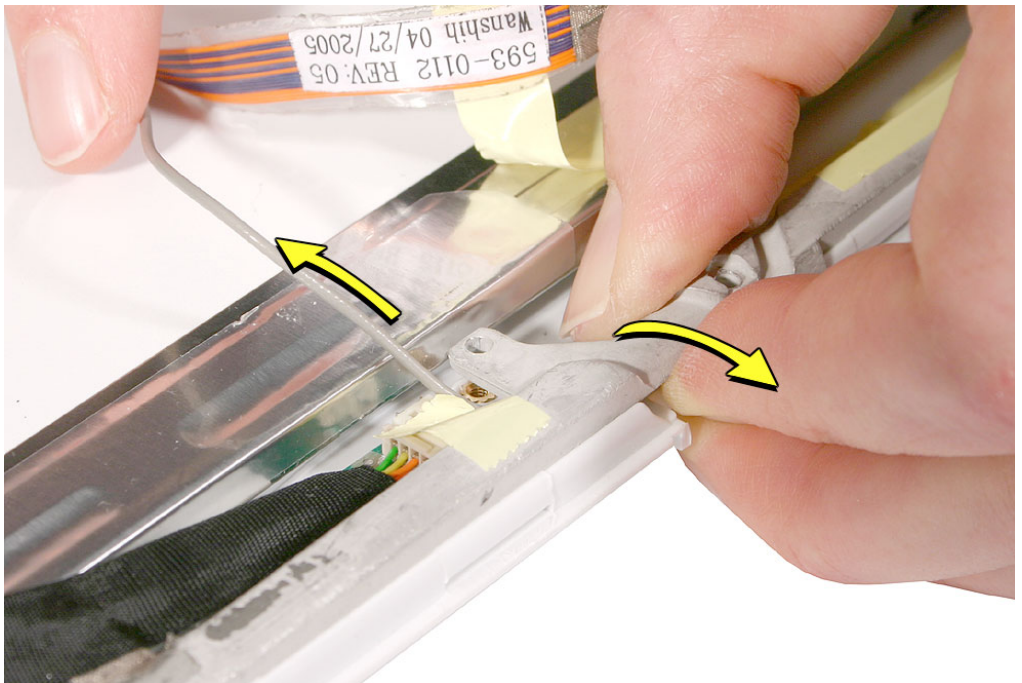

10. Loosen the gray cable from the cable guides at the right lower corner and up the right side of the bezel brace.

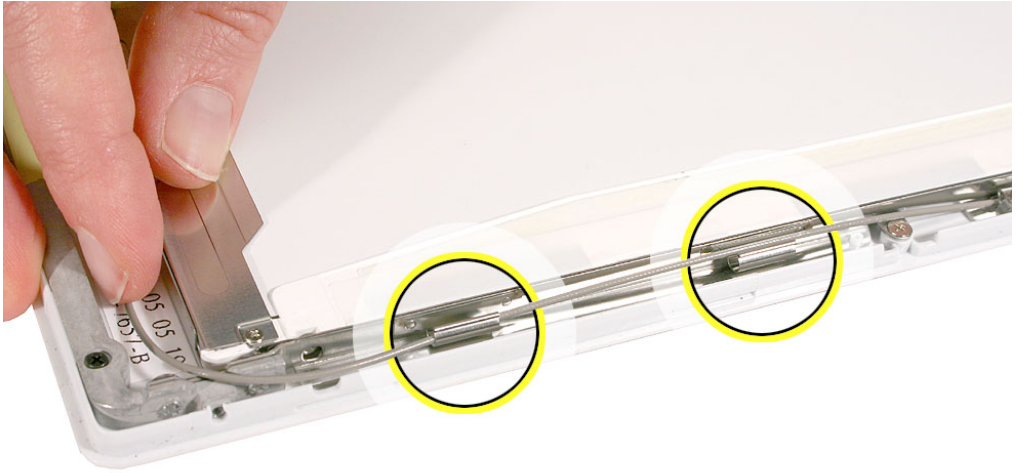

11. From the right side of the bezel brace, remove the two 3-mm long screws that secure the antenna receptor — with gray cable attached.

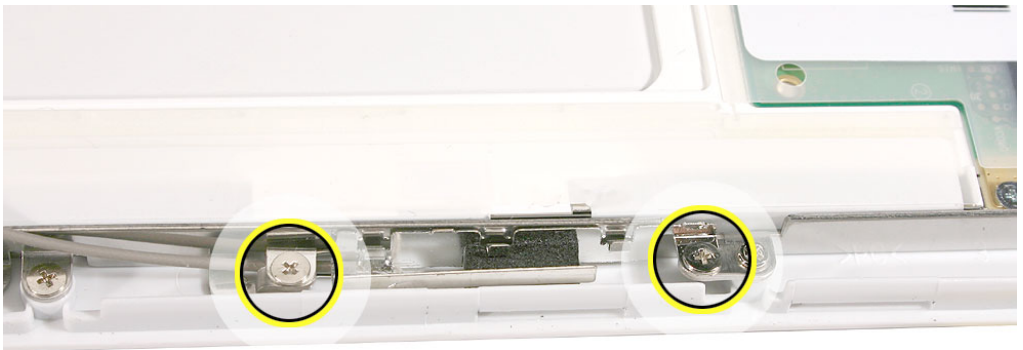

- Slide the antenna receptor toward the top of the bezel to release it from the bezel assembly.

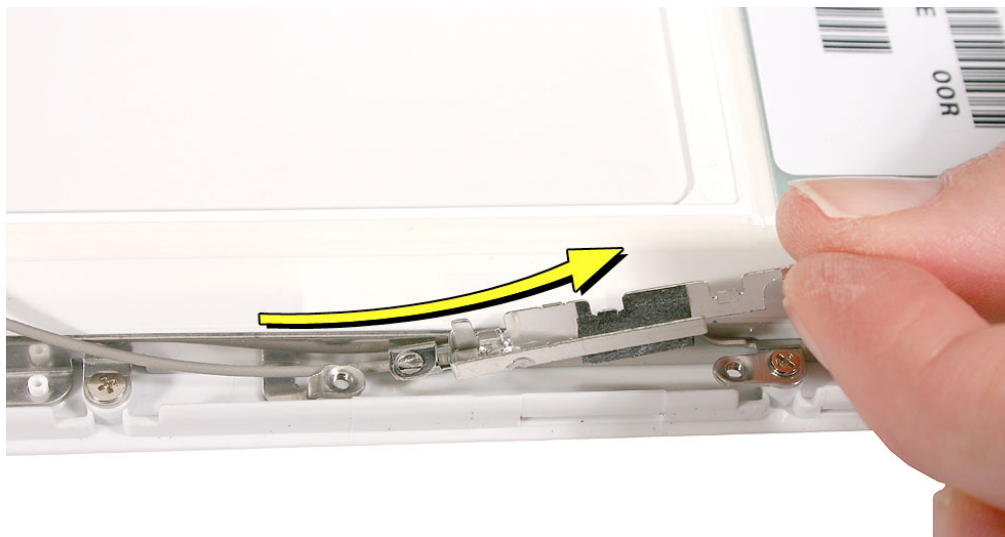

- Install the replacement AirPort Extreme/Bluetooth antenna cable assembly, and reassemble and test the computer.

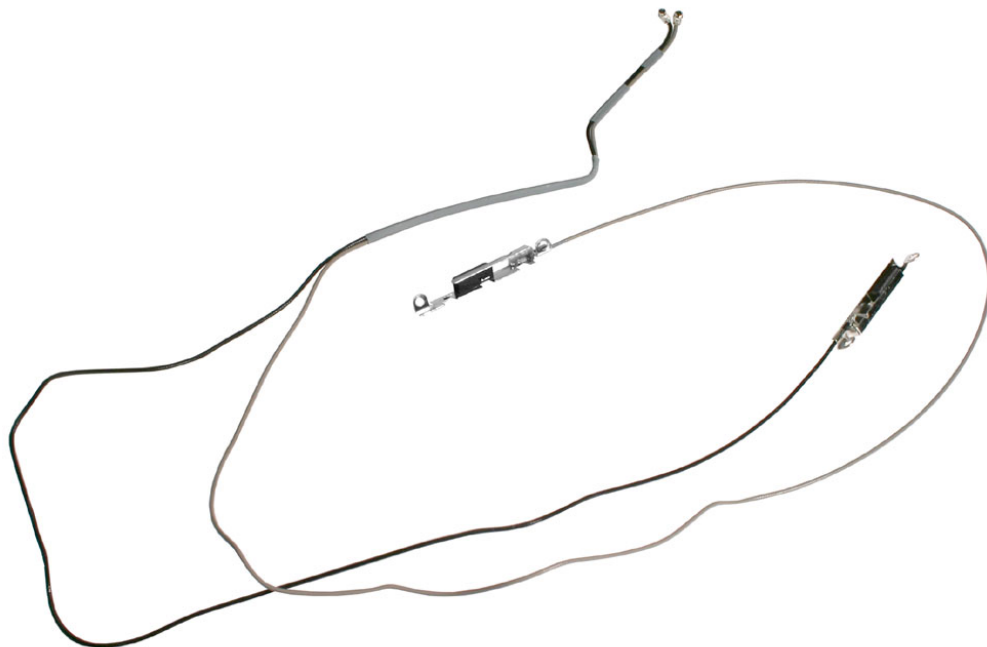



Inverter Cable

Tools

- Soft cloth
- Black stick (or other nonconductive nylon or plastic tool)

Note: To organize the screws you remove from the display assembly, use a tray with divided compartments (such as a plastic ice cube tray).

Part Location



Preliminary Steps

Before you begin, remove the following:

- Battery
- Keyboard and RAM shield
- Memory card
- Bottom case
- Bottom shield
- DC-in board

- Top case
- Top shield
- Modem
- AirPort Extreme/Bluetooth card
- Display module
- Display rear housing
- Display clutch cover
- Display shield
- Display LCD panel
- LVDS cable (or just move it aside)
- AirPort Extreme/Bluetooth antenna cables (or just remove the tape that bundles the antenna cables with the inverter cable)

Procedure

1. If tape covers the inverter cable where it exits the bezel, remove the tape.
2. Use a black stick or flat-blade jeweler's screwdriver to disconnect the inverter cable from the inverter board.

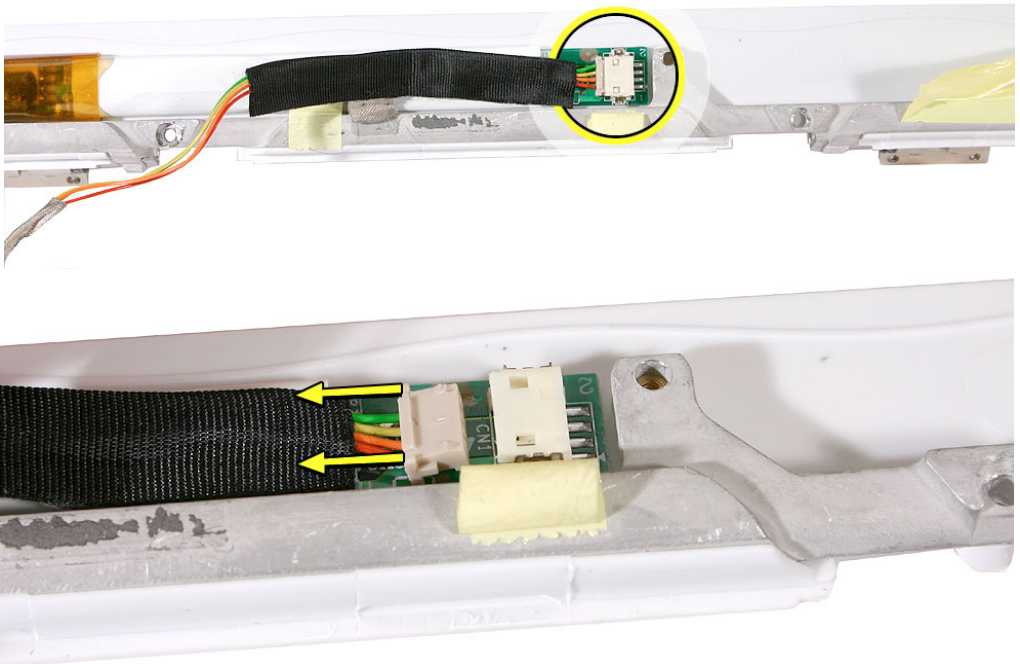

3. Install the replacement inverter cable and tape, and reassemble and test the computer.



Inverter Board

Tools

- Soft cloth
- Black stick (or other nonconductive nylon or plastic tool)

Note: To organize the screws you remove from the display assembly, use a tray with divided compartments (such as a plastic ice cube tray).

Part Location



Preliminary Steps

Before you begin, remove the following:

- Battery
- Keyboard and RAM shield
- Memory card
- Bottom case
- Bottom shield
- DC-in board
- Top case
- Top shield
- Modem
- AirPort Extreme/Bluetooth card
- Display module

- Display rear housing
- Display clutch cover
- Display shield
- Display LCD panel
- Microphone cable
- LVDS cable
- AirPort Extreme/Bluetooth antenna cable
- Inverter cable

Procedure

1. Remove the strip of tape from the inverter board, and note that the ends of the board stick to the bezel with adhesive.



2. Starting at one end of the inverter board, use a black stick to remove the inverter board from its place in the bezel.



3. Install the replacement inverter board and cable, and reassemble and test the computer.

Important: The inverter board is wrapped, as shown, with mylar and/or tape. Do not unwrap the board.

Replacement Note: Make sure the underside of the board has sufficient adhesive on both ends.



Important: On the inner side of the bezel, near the lower left corner, notice the inverted "L" that is molded into the bezel. When installing the replacement inverter board, make sure you align the upper left corner of the board with the molded marking.





Bezel Brace with Clutch Assembly

Tools

- Soft cloth
- #0 Phillips screwdriver

Replacement Note: If the tape you remove from this assembly is worn and cannot be reused, use new Kapton tape (Apple part number 922-5025).

Part Location



Preliminary Steps

Before you begin, remove the following:

- Battery
- Keyboard and RAM shield
- Memory card
- Bottom case

-
- Bottom shield
 - DC-in board
 - Top case
 - Top shield
 - Modem
 - AirPort Extreme/Bluetooth card
 - Display module
 - Display rear housing
 - Display clutch cover
 - Display shield
 - Display LCD panel
 - Microphone cable
 - LVDS cable
 - AirPort Extreme/Bluetooth antenna cables
 - Inverter cable
 - Inverter board

Procedure

Note: Although your bezel assembly might appear somewhat different than shown, the steps to follow are the same.

1. With the bezel assembly lying on a soft cloth, remove any pieces of tape.
2. From the bezel brace, remove the following Phillips screws as shown in the images that follow:
 - 6-mm long black screw at the corner of the brace (1 and 2)
 - 5-mm long screw at the upper right side of the brace and two at the left side of the brace (3, 4, and 5)
 - 3-mm long screw at the right side of the brace (6)

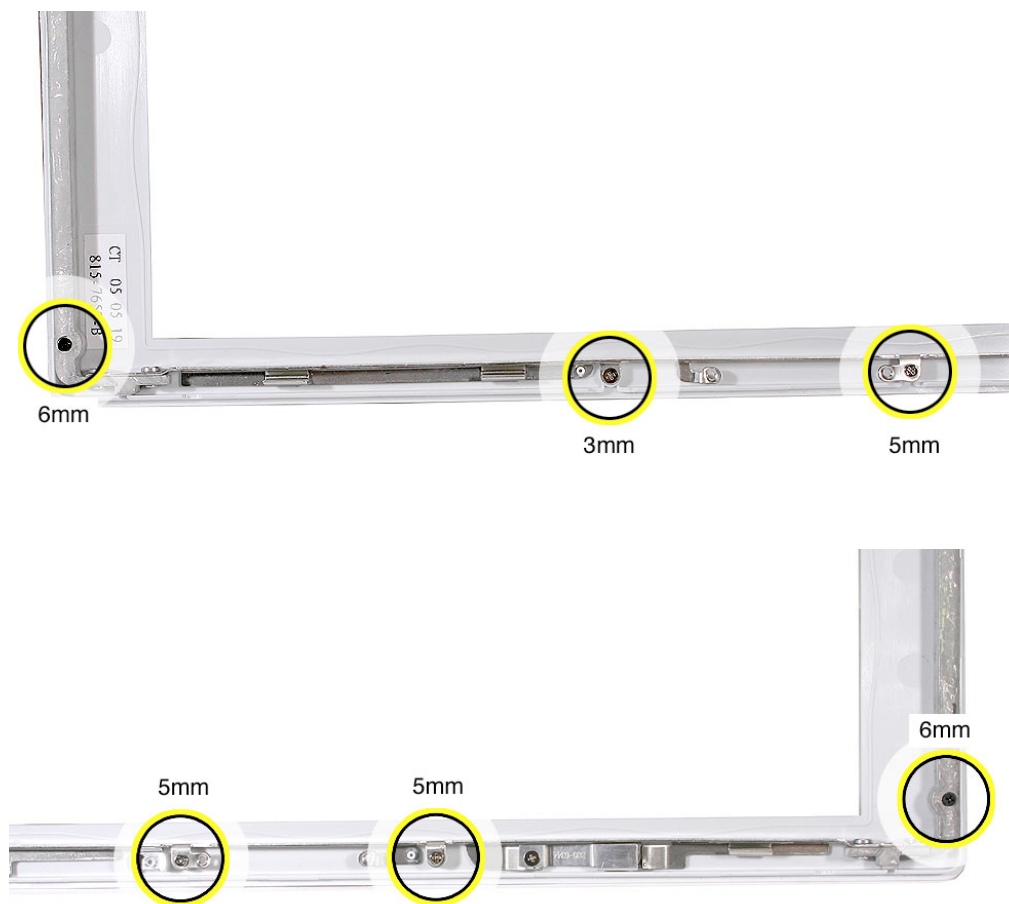

Replacement Note: Install screws in the order shown:

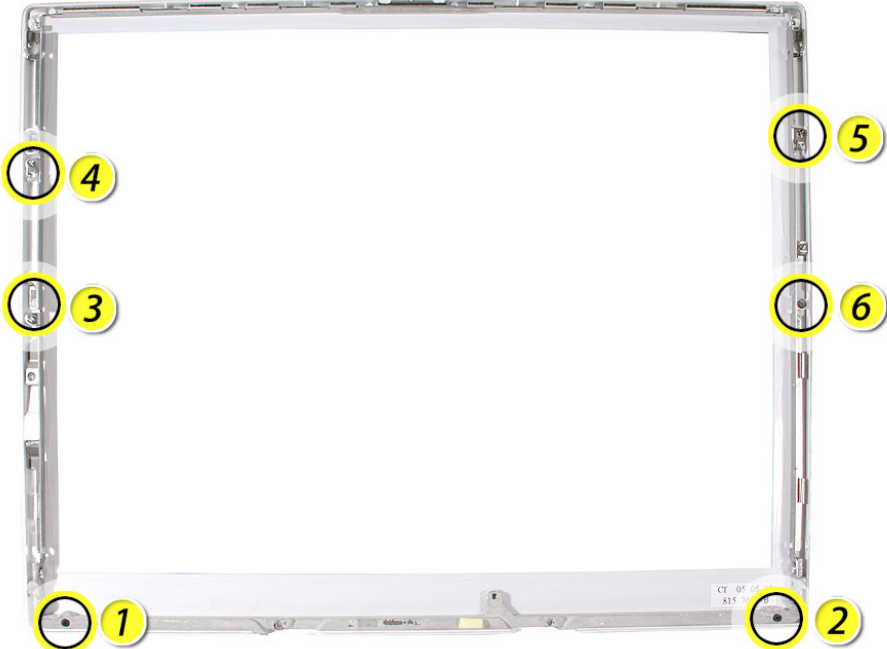

-
3. **Caution:** When removing the bezel brace, it can catch on the shielded area where the microphone was located—at the upper left side of the bezel brace. Use caution during removal and replacement so the microphone shield does not become damaged.

Carefully lift the 3-sided bezel brace with clutch assembly off of the bezel.

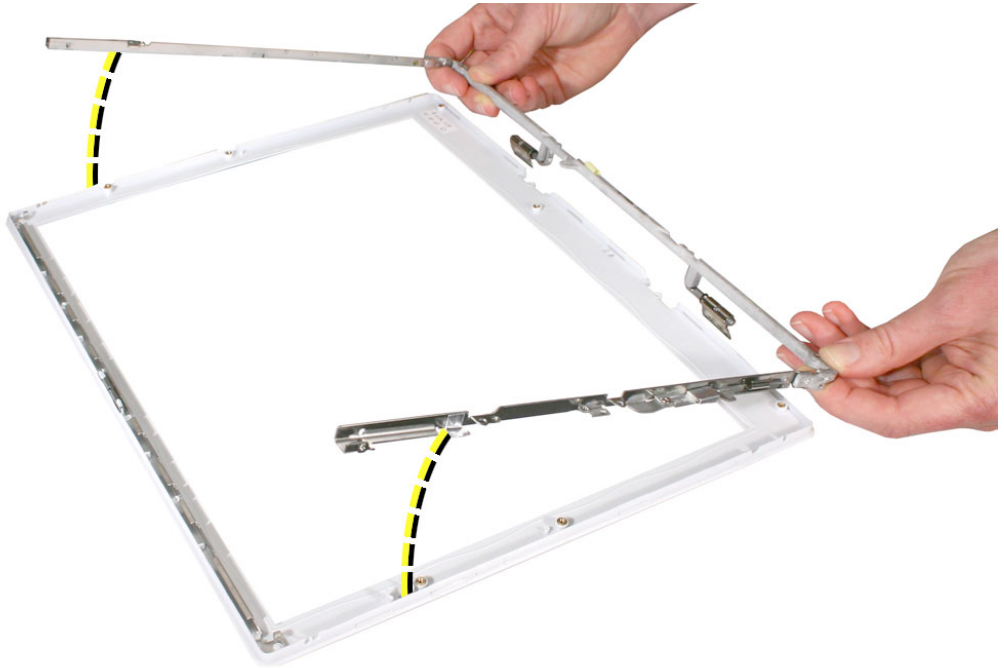

4. Install the replacement bezel brace with clutch assembly, and reassemble and test the computer.

Important: Before installing the screws in the replacement bezel brace, verify that there is a rectangular magnet on the lower left corner of the bezel brace. The magnet should be secure and flush within the small shield on the bezel brace, as shown.

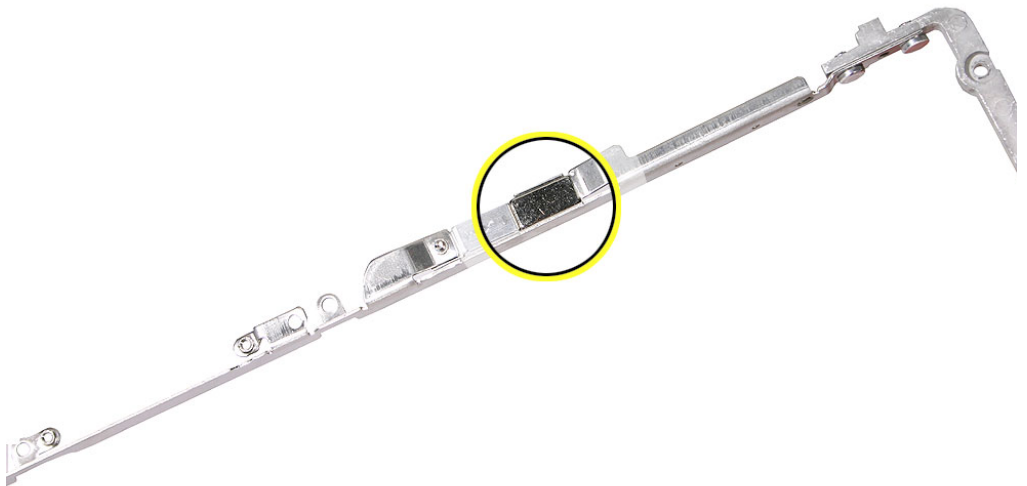
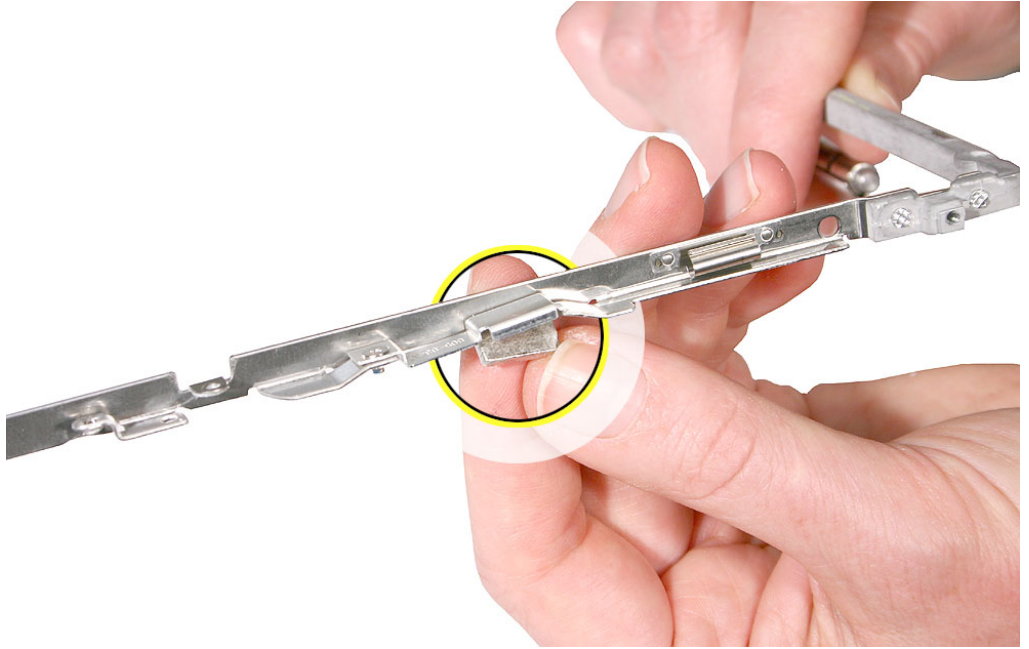



Display Bezel

Tools

With all preliminary steps performed, the only tool is a soft cloth.

Part Location



Preliminary Steps

Before you begin, remove the following:

- Battery
- Keyboard and RAM shield
- Memory card
- Bottom case
- Bottom shield
- DC-in board
- Top case
- Top shield
- Modem

-
- AirPort Extreme/Bluetooth card
 - Display module
 - Display rear housing
 - Display clutch cover
 - Display shield
 - Display LCD panel
 - Microphone cable
 - LVDS cable
 - AirPort Extreme/Bluetooth antenna cables
 - Inverter cable
 - Inverter board
 - Bezel brace with clutch assembly

Procedure

With all preliminary steps performed, the bezel is the remaining part.

1. Make sure the replacement bezel is free of dust or debris.
2. Install the replacement display bezel, and reassemble and test the computer.





Troubleshooting
iBook G4 (14-inch Mid 2005)



Symptom Charts

How to Use the Symptom Charts

The Symptom Charts included in this chapter will help you diagnose specific symptoms related to the product.

The steps to solve a symptom are listed sequentially. You might not need to perform every step before the symptom is solved. Start with the first step, and then test for the symptom. If the symptom persists, replace any modules you removed, go to the next step, and test again. Continue down the list until the symptom is solved.

AirPort Extreme/Bluetooth Card

AirPort Extreme Card not recognized

1. Use Software Update in Mac OS X system preferences or see the Apple Software Updates web page to make sure the latest version of AirPort software is installed.
2. Check Network pane in System Preferences to verify AirPort port is selected.
3. **Important:** The AirPort Extreme/Bluetooth card has specific handling precautions. Make sure you review the section "AirPort Extreme/Bluetooth Card" in the Take Apart chapter before continuing.

Reseat AirPort Extreme/Bluetooth card and make sure AirPort antenna cable is fully connected.

4. Remove and reinstall the AirPort software.
5. Replace with known-good AirPort Extreme/Bluetooth card.
6. Replace logic board.

AirPort Extreme/Bluetooth card installed and received a -3278 error

1. Check to make sure using the latest version of AirPort software.
2. **Important:** The AirPort Extreme/Bluetooth card has specific handling precautions. Make sure you review the section "AirPort Extreme/Bluetooth Card" in the Take Apart chapter before continuing.

Reseat AirPort Extreme/Bluetooth card.

3. Remove and reinstall the AirPort software.

-
4. Replace with known-good AirPort Extreme/Bluetooth card.
 5. Replace logic board.

Poor AirPort reception

1. Refer to Knowledge Base article 88258: PowerBook G4: How to Optimize AirPort reception.
2. **Important:** The AirPort Extreme/Bluetooth card has specific handling precautions. Make sure you review the section "AirPort Extreme/Bluetooth Card" in the Take Apart chapter before continuing.

Reseat AirPort Extreme/Bluetooth antenna cables on card.

3. Check AirPort Extreme/Bluetooth antenna cables for damage.
4. Replace with known-good AirPort Extreme/Bluetooth card.
5. Replace AirPort Extreme/Bluetooth antenna cables.

Battery

The battery won't charge

1. Remove any connected peripherals.
2. Try known-good power outlet.
3. Try known-good power adapter and power cord.

Note: Verify that power adapter connector glows amber or green. If the power adapter light is green, turn over the computer and press the battery button. The battery lights should glow green and stay on if the power adapter is operating correctly.

4. Try known-good battery.
5. Reset the power manager by pressing the key combination Control-Option-Shift-power.

Warning: Make sure you do not hold down the "fn" key when resetting the power manager.

Warning: Resetting the power manager means you will also need to reset the date and time (using the Date & Time control panel).

6. Try known-good DC-in board and cable assembly.
7. Replace battery transfer board.
8. Replace logic board.

Short battery life

Refer to Knowledge Base article 114154: SOP: Battery Screening Process--Worldwide.

Error Beeps

The computer automatically performs a power-on self test when it is turned on after being fully shut down (not a restart). This section describes what to do if beeps are heard during the startup.

Note: The computer has a memory expansion slot that accepts a 1.25-inch (or shorter) PC-2700S or better, SO-DIMM memory card. Refer to the Memory Replacement instructions for removal and installation.

Computer beeps once at startup

1. One beep means that no RAM is detected.
2. If a RAM card is installed in the expansion slot, remove it and put in known-good and compatible RAM and restart.
 - If symptom does NOT repeat, replace RAM card.
 - If symptom repeats, replace logic board.
3. If no RAM card is installed, replace logic board.

Computer beeps twice at startup

1. Two beeps means that EDO memory is installed in the expansion slot. The iBook does not accept EDO memory.
2. Replace RAM card with known-good and compatible RAM and restart.
 - If symptom repeats, replace logic board.

Computer beeps three times at startup

1. Three beeps means that no RAM banks passed memory testing.
2. If a RAM card is installed in the expansion slot, remove it and put in known-good and compatible RAM and restart.
 - If symptom does NOT repeat, replace RAM card.
 - If symptom repeats, replace logic board.
3. If no RAM card is installed, replace logic board.

Computer beeps four times at startup

1. Four beeps indicates a bad checksum for the remainder of the boot ROM. The ROM (which is located on the logic board) is bad.
2. If a RAM card is installed in the expansion slot, remove it and put in known-good and compatible RAM and restart.

-
- If symptom does NOT repeat, replace RAM card.
 - If symptom repeats, replace logic board.
3. If no RAM card is installed, replace logic board.

Related articles:

58442: Power On Self-Test Beep Definition - Part 2

111772: iBook (Dual USB): Beeps Are Heard at Startup (one to four beeps)

Hard Drive

Hard drive will not initialize

1. Boot from iBook Software Install CD and see if the hard drive mounts on the desktop.
2. Boot from the Mac OS X software install CD. Under the File menu, select Disk Utilities and initialize the disk or run Disk First Aid.
3. If no hard drive is found in Drive Setup, verify the hard drive connections.
4. Try known-good hard drive with known-good OS X software installed.
5. Replace hard drive if test above passes.

Important: If the computer is under warranty and data recovery is required, refer to Article 31077: Hard Drive Data Recovery & Warranty Implications, for important information.

6. Replace logic board.

The internal hard drive does not spin

1. Disconnect any connected peripherals.
2. Try known-good power outlet. Ensure system has power.
3. Try known-good power adapter and power cord. Ensure system has power.
4. Boot from a Mac OS system CD.
5. Verify Drive Setup does not recognize the hard drive.
6. Verify connections and check hard drive connector for damage.
7. Try known-good hard drive with known-good OS X software installed.
8. Replace hard drive if test above passes.

Noisy hard drive

Some sounds such as ticking or a rotational noise are normal. Refer to Knowledge Base article 30593: PowerBook: Hard Drives and Noise.

Keyboard

No response from any key on keyboard

1. Remove any connected peripherals.
2. Visually verify that no keys are stuck in the down position.
3. Boot from a Mac OS system CD to verify that it is not a software problem.
4. Turn off the computer. Disconnect the keyboard connector and inspect connectors.
5. Replace keyboard.
6. Replace logic board.

The keyboard lock is damaged or won't lock

1. Verify that keyboard is installed properly so the lock lines up with the notch in the top case.
2. Replace keyboard.

Keycap pops off

1. If the keycap and scissors mechanism is not broken, it can probably be reinstalled. To replace the keycap, refer to Knowledge Base article 88106: PowerBook G4: Keycap Replacement.
2. Replace keyboard.

Modem

No modem dial tone

1. Check that the correct modem is selected. In Mac OS X, check Network Setup.
2. Verify known-good analog (not digital) telephone line.
3. Verify known-good RJ11 telephone cable.
4. Verify RJ11 cable is not plugged into Ethernet port.
5. Inspect RJ11 connector and modem port for pin damage.
6. Verify RJ11 telephone cable is firmly installed in the modem port.
7. If using Apple Remote Access, select Ignore Dial Tone in the Modem control panel. If the modem connects with this settings selected, try another phone line. If using a terminal or communications program, enter atx1 to disable tone detection. To reset the modem back to the factory settings, enter atz.
8. Verify modem 2-pin connector is plugged into modem correctly.
9. Replace the modem 2-pin connector cable.

-
10. Replace modem.

Related article:

106592: Mac OS X: How to Use Modem AT Commands

Cannot send fax

1. Check that Network connection in System Preferences is set to Internal Modem.
2. Refer to Knowledge Base article 25746: Mac OS X 10.3: Fax doesn't send.

Cannot receive fax

Check that "Receive faxes on this computer" is selected in the Print & Fax area of System Preferences.

Related articles:

25731: Mac OS X 10.3: Receiving faxes and connecting to the Internet

25596: Mac OS X 10.3: About Receiving Faxes

Modem drops connection

1. Try known-good phone line.
2. Refer to Knowledge Base article 106748: Mac OS X: Troubleshooting a dial-up/PPP Internet connection.

Optical Drive

The optical drive does not accept CD or DVD disc (mechanical failure)

1. Verify disc is not warped.
2. Verify drive slot has no foreign object in channel.
3. Verify disc is properly seated in the carrier.
4. Replace optical drive.

The disc icon does not show up on the desktop, or a dialog box appears to initialize disc

1. Verify the correct type of disc is being used.
2. Try cleaning the disc. It may not mount if dirty or scratched.
3. Verify media is positioned correctly: data side down.
4. Try a different disc.
5. Listen to verify that the disc spins.

-
6. Reseat optical drive cable.
 7. Verify the logic board connection by trying a known-good optical drive and disc.
 8. Replace optical drive cable.
 9. Replace optical drive.

The optical drive does not eject CD or DVD disc

1. Verify disc is not in use by quitting any applications that may be using the disc.
2. Press and hold Media Eject key at top right corner of keyboard. If that does not work, hold down Function (fn) key and Media Eject key.
3. Drag disc icon to trash or select it and press Command-E.
4. Choose Restart from Apple menu while holding down trackpad button.
5. Refer to Take Apart to remove the stuck disc and replace the optical drive.

Related article:

106752: Macintosh: How to Eject a Disc When Other Options Do Not Work

The combo drive does not write at maximum speed

Refer to Knowledge Base article 86186: PowerBook G4, iBook: Combo Drive Does Not Write CD-R Media at Maximum Speed.

Ports

The FireWire or USB port is not recognizing known devices

1. Completely shut down, then press the power button to start the computer.
2. Use Software Update in Mac OS X system preferences to verify that the latest software is installed.
3. Use Apple System Profiler to verify that the computer is recognizing the bus.
4. For USB, test ports with an Apple keyboard or mouse.
5. Verify USB port provides power to USB device.
6. For FireWire, test by connecting another computer in FireWire Target Disk Mode. Refer to article 58583: How to Use FireWire Target Disk Mode.
7. Verify that drivers are installed properly for third party, if needed.
8. Try other port if available.
9. Try a different cable.
10. Try known-good device.

-
11. If self-powered make sure that the power supply is connected and device's LED indicates that it is getting power.
 12. Replace logic board.

A USB device not recognized by computer

Note: If you are trying to use a serial device with a USB/Serial adapter, check with the manufacturer of the adapter for compatibility.

1. Completely shut down, then press the power button to start the computer.
2. Try known-good Apple USB keyboard or mouse to verify the port is working properly.
3. Verify current driver for the device is installed.
4. If a camera, turn on camera after initiating download with camera application.
5. Try the other USB port.
6. Try known-good cable.
7. Try different USB device on same port.
8. Eliminate chain by plugging in only one peripheral.
9. Replace logic board.

Sound

Distorted sound from speakers

1. Verify sound is correct with external speakers/headphones. If sound is correct, replace top case.
2. Verify speaker cables are inserted correctly, and check cables for damage.
3. Check balance in System Preferences: Sound: Output.
4. Compare same sound with two different units to make sure that sound is actually distorted.
5. Replace top case.
6. Replace logic board.

No sound from speaker(s)

1. Reset PRAM (Press the power button, then hold down the Option-Command-P-R keys until you hear the startup chime at least one additional time after the initial startup chime).
2. Verify that the speaker cable is connected properly to logic board, and check cable for damage.

-
3. Use the Software Update control panel to verify that the latest audio update has been installed.
 4. Press the F3 key (with the fn key pressed and not pressed) to verify that mute mode is not enabled.
 5. Press the F4 or F5 key (with the fn key pressed and not pressed) to check the volume setting.
 6. Verify no external speakers or headphones are plugged in.
 7. Shutdown computer and restart.
 8. Replace top case.
 9. Replace logic board

Related article:

58463: iBook: Sound Capabilities

Startup

The computer will not power on

1. Remove any connected peripherals.
2. Try known-good power outlet.
3. Try known-good power adapter and power cord.
4. Remove battery.
5. Press Caps Lock key to see if light on key comes on. If it does, hold power button down for six seconds to shut down the computer and restart.
6. Reset the power manager by pressing the key combination Control-Option-Shift-power.

Warning: Make sure you do not hold down the "fn" key when resetting the power manager.

Warning: Resetting the power manager means you will also need to reset the date and time (using the Date & Time control panel).

7. Reset PRAM (Press the power button, then hold down the Option-Command-P-R keys until you hear the startup chime at least one additional time after the initial startup chime).
8. Disconnect keyboard completely. Inspect connectors. Restart with keyboard disconnected.
9. Remove any additional RAM.
10. **Important:** The AirPort Extreme/Bluetooth card has specific handling precautions.

Make sure you review the section "AirPort Extreme/Bluetooth Card" in the Take Apart chapter before continuing.

Remove AirPort Extreme/Bluetooth card.

11. Try known-good DC board.
12. Verify cable connections and check cables for damage.
13. Verify power button is connected properly to logic board, if power button is not functioning correctly or damaged, replace the top case.
14. Replace logic board.

At startup, a dialog box comes up stating “kernel panic” in Mac OS X

1. If a RAM card is installed in the expansion slot, remove it and restart.
 - If symptom repeats, replace logic board.
 - If symptom does not repeat, replace RAM card with known-good RAM card and restart.
2. If no RAM card is installed, replace logic board.

Related article:

111772: iBook (Dual USB): Beeps Are Heard at Startup (one to four beeps)

Display

No display, or dim display, but computer appears to operate correctly (if dim, display shows startup icon and/or desktop)

1. Remove any connected peripherals.
2. Try known-good power outlet, power adapter and power cord.
3. Press F2 (with the fn key pressed and not pressed) to increase the screen brightness setting.
4. Reboot the computer—hold down the Control and Command keys and press the Power button, or press and hold the Power button for 5 to 10 seconds to shut down the computer, then press the Power button to restart.
5. Reset the power manager by pressing the key combination Control-Option-Shift-power.

Warning: Make sure you do not hold down the "fn" key when resetting the power manager.

Warning: Resetting the power manager means you will also need to reset the date and time (using the Date & Time control panel).

-
6. Reset PRAM (Press the power button, then hold down the Option-Command-P-R keys until you hear the startup chime at least one additional time after the initial startup chime).
 7. Connect an external display, and check for video on external display.
 - If video is fine on external display, troubleshoot LCD panel and verify cable connections to inverter and LCD.
 - If video symptom is same on external display, replace logic board.
 8. Verify backlight cable and LVDS cable connections are seated properly and that the cables are not damaged (refer to display assembly replacement instructions).
 9. Replace LCD panel.
 10. Verify cable connections and check cables around the hinges for damage.
 11. Replace logic board.

When displaying a single color over the screen area, the LCD panel shows one or more pixels that are not properly lit

Active-matrix LCD technology uses rows and columns of addressable locations (pixels) that render text and images on screen. Each pixel location has three separate subpixels (red, green, and blue) that allow the image to be rendered in full color. Each subpixel has a corresponding transistor responsible for turning the subpixel on or off.

There are typically millions of these subpixels on an LCD display. For example, the LCD panel used in the Apple Cinema HD display is made up of 2.3 million pixels and 6.9 million red, green, and blue subpixels. Occasionally, a transistor does not work perfectly, which may result in the affected subpixel being turned on (bright) or turned off (dark). With the millions of subpixels on a display, it is quite possible to have a low number of faulty transistors on an LCD. Therefore, a certain number of subpixel anomalies is considered acceptable. Rejecting all but perfect LCD panels would significantly increase the retail price for products using LCD displays. These factors apply to all manufacturers using LCD technology—not just Apple products.

To determine whether or not the display has an acceptable number of pixel anomalies, follow the steps below:

1. Set the display image to one of the following colors: all-white display, all-red display, all-green display, or all-blue display.
2. Using a jeweler's loupe, pocket microscope, or other magnifying device, identify and count each subpixel anomaly:
 - Bright subpixel anomaly = subpixel that is always on
 - Dark subpixel anomaly = subpixel that is always off

3. **Important:** Check the number of subpixel anomalies with the following chart:

LCD Size (inches)	Acceptable Number of Subpixel Anomalies			Replace the LCD Panel		
	Bright	Dark	Combination	Bright	Dark	Combination
12.1 to 15.2	up to 3	up to 5	up to 7	4 or more	6 or more	8 or more

4. If the number of subpixel anomalies exceeds the acceptable number listed in the chart, replace the LCD panel.
5. If the number of subpixel anomalies is acceptable, explain to the customer that the pixel anomalies are within specifications, and no repair is necessary.

Important: Do not release the specifications to customers. Instead, inform them that a certain number of subpixel anomalies is considered acceptable, and these factors apply to all manufacturers using LCD technology—not just Apple products.

Scrambled or distorted video

Check for video on external display.

- If video is fine on external display, replace LVDS cable.
- If video is scrambled or distorted on external display, replace LCD panel.

Video (S-Video and Composite adapter)

No video on an external device

1. Make sure you are using the S-Video and Composite adapter cable.
2. Verify TV or VCR is set up properly with correct source.
3. Try different TV or VCR. Check owner's manual for TV or VCR.
4. Replace adapter cable.
5. Replace logic board.

The display is rolling (PAL instead of NTSC)

1. Make sure you are not using Apple's A/V Video Cable.
2. Make sure you are using the S-Video and Composite adapter cable.
3. In Mac OS X, go to the Displays system preference to change the setting.
4. Try a different TV or VCR.
5. Try a different adapter cable.
6. Replace logic board.

Display shows ghosting (signal reflection)

1. Verify that cables are correctly installed and firmly seated. Check cables for damage.
2. Replace video adapter.

Video (VGA adapter)

No video on an external device

1. Verify monitor that is used in testing is known-good and is supported by this computer.
2. Try known-good VGA adapter.
3. Replace logic board.
4. Replace VGA adapter cable.
5. Replace logic board.

Display shows ghosting (signal reflection)

1. Verify that cables are correctly installed and firmly seated. Check cables for damage.
2. Replace video adapter.

Misc. Symptoms

The computer runs with battery, but not with the power adapter plugged into wall outlet

1. Try known-good power outlet.
2. Try known-good power adapter and power cord.

Note: Verify that power adapter connector glows amber or green. If the power adapter light is green, turn over the computer and press the battery button. The battery lights should glow green and stay on if the power adapter is operating correctly.

3. Reset the power manager by pressing the key combination Control-Option-Shift-power.

Warning: Make sure you do not hold down the "fn" key when resetting the power manager.

Warning: Resetting the power manager means you will also need to reset the date and time (using the Date & Time control panel).

4. Replace the DC-in board and verify connection to the logic board.
5. Replace logic board.

Related article: 88133: iBook (Dual USB): Using PowerBook G4 Adapter

The computer runs when plugged into a wall outlet but not on battery power

1. Reseat battery to verify battery is seated correctly with battery lock engaged.
2. Try known-good charged battery.
3. Reset the power manager by pressing the key combination Control-Option-Shift-power.

Warning: Make sure you do not hold down the "fn" key when resetting the power manager.

Warning: Resetting the power manager means you will also need to reset the date and time (using the Date & Time control panel).

4. Verify connection and cables on battery transfer board.
5. Replace battery transfer board.
6. Replace logic board.

The cursor does not move when you are using trackpad

1. Verify that no USB device is connected.
2. Boot from a Mac OS system CD to verify that it is not a software problem.
3. Reset the power manager by pressing the key combination Control-Option-Shift-power.

Warning: Make sure you do not hold down the "fn" key when resetting the power manager.

Warning: Resetting the power manager means you will also need to reset the date and time (using the Date & Time control panel).

4. Check trackpad cable and connection to the logic board (see separate Top Case replacement instructions for location under RAM shield).
5. Replace top case.
6. Replace logic board.

The cursor intermittently does not move or moves erratically

Note: User must touch with the surface of only one finger at a time and point directly down on the trackpad surface.

1. Clean trackpad surface (with computer off, using a non-static-inducing material).
2. Completely shut down, then press the power button to start the computer.

-
3. Reset the power manager by pressing the key combination Control-Option-Shift-power.

Warning: Make sure you do not hold down the "fn" key when resetting the power manager.

Warning: Resetting the power manager means you will also need to reset the date and time (using the Date & Time control panel).

4. Reset PRAM (Press the power button, then hold down the Option-Command-P-R keys until you hear the startup chime at least one additional time after the initial startup chime).
5. Remove and reseal memory card.
6. Try unit on battery power. If problem goes away, replace power adapter.
7. Place a Mac OS system CD in the optical disc drive, press the start button and hold down the "C" key. Check the cursor movement, to see if the problem is software.
8. Check trackpad cable and connection to the logic board (see separate Top Case replacement instructions for location under RAM shield).
9. Replace top case.
10. Reseat the heatsink if it is not properly secured.
11. Replace logic board.

The microphone is not working

1. Check the signal level and level meter and adjust the gain.
2. Reset PRAM (Press the power button, then hold down the Option-Command-P-R keys until you hear the startup chime at least one additional time after the initial startup chime).
3. Verify microphone cable connection to logic board, and check cable for damage.
4. Replace microphone cable.
5. Replace logic board.

The latching mechanism that holds the display closed is not working

Note: As the display closes against the top case, a hook in the top of the display housing should be magnetically pulled down into a slot in the top case, and secured. When the latch button is pushed, the hook should release and retract into the display housing, allowing the display to open.

1. Verify hook operation by exercising the latch mechanism.
2. If the hook does not operate properly, replace the display assembly.
3. If the latch or latch button does not operate properly, replace the top case assembly.

Fan fails

1. Check fan cable connection, and check cable for damage.
2. Check fan for loose parts stuck in fan blades.
3. Replace fan.
4. Replace logic board.

Trackpad works intermittently

The trackpad operation can be affected by hand lotion, humidity, dangling jewelry, and the use of more than one finger on the trackpad.

1. Check for environmental factors such as humidity, hand lotion, or jewelry.
2. Clean the trackpad with a clean, dry lint-free cloth.

Related articles:

17228: Portables: Jumpy or Erratic Trackpad Operation

58389: PowerBook and iBook: Trackpad Does Not Respond

Greasy substance in battery bay

A small amount of grease is used on the springs in the battery bay. Inform customers that the grease helps the springs operate correctly. The grease is not harmful and should not cause alarm. However, if it comes in contact with skin, wash it off with soap and water.

Refer to Knowledge Base article 88369: iBook: White Greasy Substance in Battery Bay.

Block Diagram

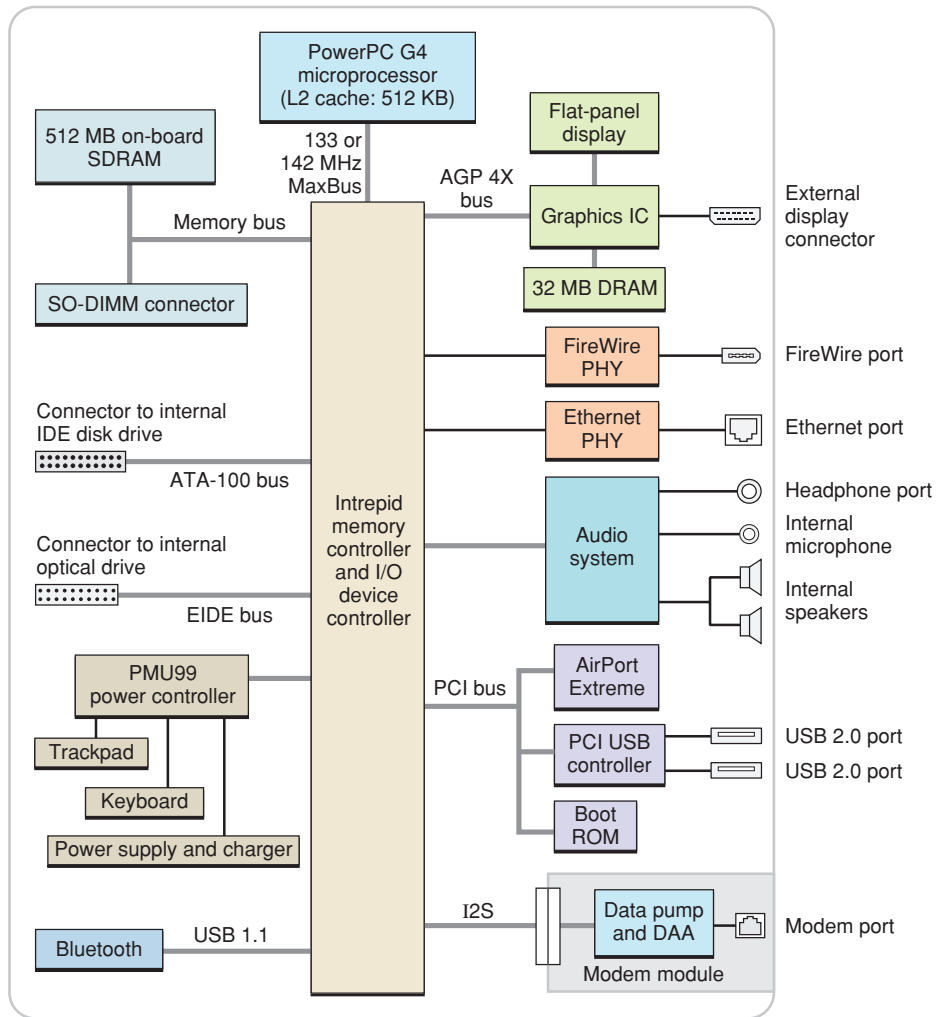

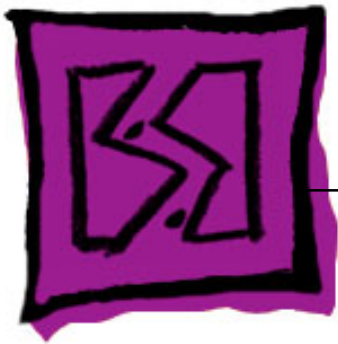

Views

iBook G4 (14-inch Mid 2005)

Slot-Load Optical Drive Side View



Ports Side View



Bottom Case View

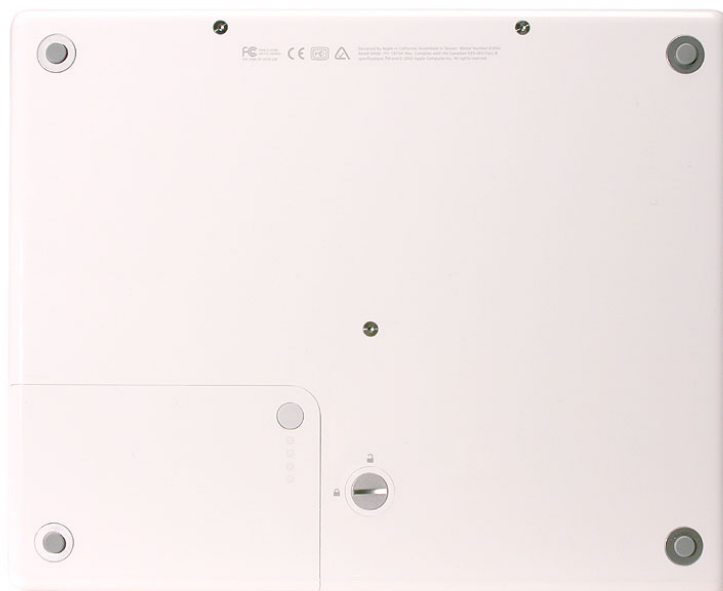

iBook G4 (14-inch Mid 2005): Main Exploded View

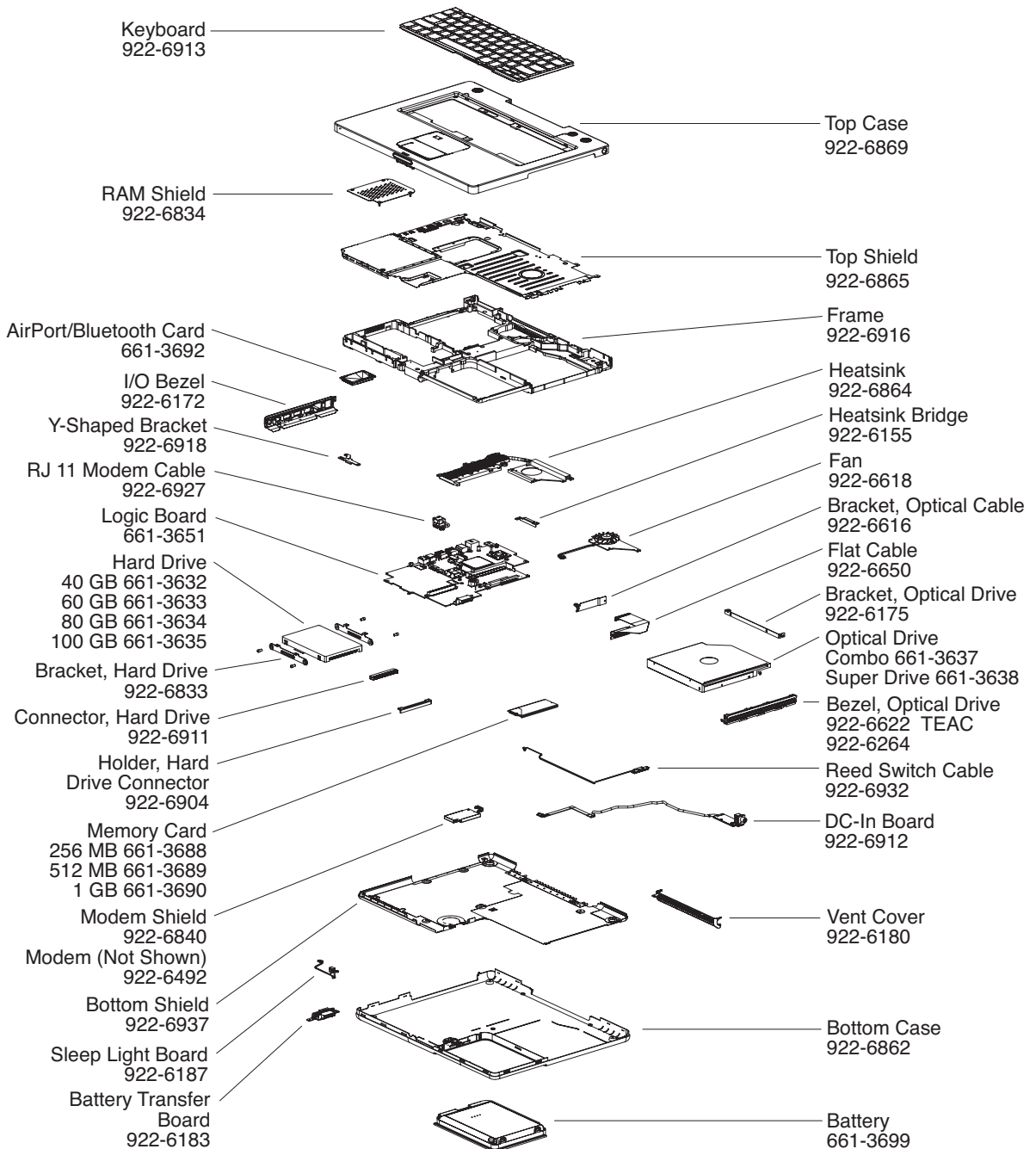

iBook G4 (14-inch Mid 2005): Display Exploded View

