



# Apple Multiple Scan 15 AV Display

---





## Basics

---

Apple Multiple Scan 15AV  
Display





## Overview



The Apple Multiple Scan 15AV Display is a 15-inch (13.75-inch viewable image size) color monitor that supports a variety of resolutions and that features a built-in amplifier and front-facing stereo speakers.





## Monitor Features

Features of the Apple Multiple Scan 15AV Display include the following:

- Antistatic, antiglare screen surface
- Multiple screen resolutions ranging from 640x480 to 1024x768
- Front-facing, CD-quality speakers
- Easy-access front headphone jack
- Support for Mac OS and Windows 95
- Compatible with Apple ColorSync software for the closest possible color match between what is seen on the monitor and what is printed or scanned





## Specifications

---

Apple Multiple Scan 15AV  
Display





## Characteristics

### Picture Tube

15-in. CRT (13.75-in. diagonal viewable image size)

Raster Size: 10.6 in. x 7.9 in. (270 mm x 200 mm)

Multiple scan

Antistatic, antiglare surface treatment

Dot Pitch: 0.28 mm

White Point: 9300° K

Shipping Brightness: 25 foot Lamberts ( $\pm 5$  fL)

### Phosphor

Aluminized P22 (red, green, blue)

Phosphor CIE Coordinates:

Red      $x = 0.610 \pm 0.020$       $y = 0.342 \pm 0.020$

Green    $x = 0.298 \pm 0.020$       $y = 0.588 \pm 0.020$

Blue     $x = 0.151 \pm 0.015$       $y = 0.064 \pm 0.015$





## Screen Resolution

### Macintosh

640x480 at 60 Hz in VGA mode

640x480 at 67 Hz in Macintosh mode

800x600 at 60 Hz in SVGA mode

800x600 at 72 Hz in SVGA mode

832x624 at 75 Hz in Macintosh mode

1024x768 at 60 Hz in Macintosh mode

1024x768 at 70 Hz in Macintosh mode

1024x768 at 75 Hz in Macintosh mode

### PC-Compatibles

640x480 at 60 Hz in VGA mode

800x600 at 60 Hz in SVGA mode

800x600 at 72 Hz in SVGA mode

1024x768 at 60 Hz in SVGA mode

1024x768 at 70 Hz in SVGA mode

1024x768 at 75 Hz in SVGA mode





**Cable Connector**

15-pin miniature D-type

**Input Signals**

Red, green, and blue signals; separate sync

**Audio**

Response: 50 Hz to 20,000 Hz

Output: 2 W

SPL: 82 db @ 1 kHz, 1 meter







## **System Requirements**

Power Macintosh, Macintosh Centris, Macintosh Quadra, some Macintosh Performas, or any NuBus compatible Macintosh with a Macintosh Display Card 24AC.

Macintosh II family, PowerBooks, Duo and Mini Dock, some Macintosh Performa, Macintosh LC, LC II, LC III, and Macintosh computers with Display Cards 4•8, 8•24, or 8•24GC installed work in 640x480 mode. Other modes possible with additional adapters.

System software version 7.1 or later





## Monitor Timings

640x480  
Resolution @ 60 Hz

Horizontal Timing  
Back Porch: 48 dots  
H SYNC: 96 dots  
Front Porch: 16 dots  
1 dot: 39.72 ns  
1 H: 31.77  $\mu$ s  
1/dot: 25.175 MHz

Vertical Timing  
Back Porch: 33 H  
V SYNC: 2 H  
Front Porch: 10 H  
1/H: 31.5 kHz  
1 V: 16.67 ms

640x480  
Resolution @ 67 Hz

Horizontal Timing  
Back Porch: 96 dots  
H SYNC: 64 dots  
Front Porch: 64 dots  
1 dot: 33.06878 ns  
1 H: 28.5714  $\mu$ s  
1/dot: 30.24 MHz

Vertical Timing  
Back Porch: 39 H  
V SYNC: 3 H  
Front Porch: 3 H  
1/H: 35.0 kHz  
1 V: 15.0 ms





## Monitor Timings

800x600  
Resolution @ 60 Hz

Horizontal Timing  
Back Porch: 88 dots  
H SYNC: 128 dots  
Front Porch: 40 dots  
1 dot: 25.0 ns  
1 H: 26.4  $\mu$ s  
1/dot: 40.0 MHz

Vertical Timing  
Back Porch: 23 H  
V SYNC: 4 H  
Front Porch: 1 H  
1 H: 37.879  $\mu$ s  
1/H: 16.58 kHz  
1 V: 16.58 ms

800x600  
Resolution @ 72 Hz

Horizontal Timing  
Back Porch: 64 dots  
H SYNC: 120 dots  
Front Porch: 56 dots  
1 dot: 20.0 ns  
1 H: 20.800  $\mu$ s  
1/dot: 50.0 MHz

Vertical Timing  
Back Porch: 23 H  
V SYNC: 6 H  
Front Porch: 37 H  
1/H: 48.077 kHz  
1 V: 13.853 ms





## Monitor Timings

832x624  
Resolution @ 75 Hz

Horizontal Timing  
1/H: 49.7 kHz  
Back Porch: 224 dots  
H SYNC: 64 dots  
Front Porch: 32 dots  
1 H: 20.1  $\mu$ s  
1/dot: 57.28 MHz

Vertical Timing  
Back Porch: 38 H  
V SYNC: 3 H  
Front Porch: 2 H  
1 V: 13.41 ms

1024x768  
Resolution @ 75 Hz

Horizontal Timing  
Back Porch: 160 dots  
H SYNC: 136 dots  
Front Porch: 24 dots  
1 dot: 15.385 ns  
1 H: 20.677  $\mu$ s  
1/dot: 65.0 MHz

Vertical Timing  
Back Porch: 29 H  
V SYNC: 6 H  
Front Porch: 3 H  
1/H: 48.363 kHz  
1 V: 16.667 ms





## Controls and Ports

### User Controls

Front Panel: power, select, up, down, recall, brightness, contrast, sound volume

Additional picture controls available using the select button: horizontal and vertical shift, horizontal and vertical size

Automatic degauss at power-on; manual degauss by turning power switch off, then on (capable of full degauss after monitor is turned off for 20 minutes or more)

### I/O Ports

Headphone/Speaker: one input port and one pass-through output port





## Physical and Electrical

### Power Supply

Voltage: 100–240 VAC

Frequency: 50–60 Hz

Power: 75 W maximum; 8 W sleep mode

### Input Frequency Range

Horizontal: 30 kHz to 60.2 kHz

Vertical: 56 Hz to 75 Hz

### Size and Weight

Height: 14.93 in. (383 mm  $\pm$  5 mm)

Width: 17.3 in. (443 mm  $\pm$  5 mm)

Depth: 15.4 in. (395 mm  $\pm$  5 mm)

Weight: 31 lb. (14 kg)

### Monitor Stand

Removable tilt-and-swivel stand





## Environmental

### **Temperature**

Operating: 50°F to 104°F (10°C to 40°C)

Shipping: -4°F to +151°F (-40°C to +65°C)

Storage: 32°F to 140°F (0°C to 60°C)

### **Humidity**

20% to 95% (noncondensing) over the range of 77°F to 104°F  
(25°C to 40°C)

### **Altitude**

Operating: 0 to 10,000 ft. (0 to 3,048 m)

Transit: 0 to 15,000 ft. (0 to 4,500 m)

### **Power Saving Feature**

Conforms to the Energy Star Program of the United States  
Environmental Protection Agency





## Troubleshooting

Apple Multiple Scan 15AV  
Display







## General

The Symptom Charts included in this chapter will help you diagnose specific symptoms related to your product. Because cures are listed on the charts in the order of most likely solution, try the first cure first. Verify whether or not the product continues to exhibit the symptom. If the symptom persists, try the next cure. (**Note:** If you have replaced a module, reinstall the original module before you proceed to the next cure.)

For additional assistance, contact Apple Technical Support.





## First Checklist

**Important:** Many Apple Multiple Scan 15AV display modules returned for repair are found to be fully operational. Read this checklist before you return a module, and prevent needless module replacement and unnecessary time delays.

 **The Apple Multiple Scan 15AV Display is not compatible with all computers.**

This display works with both Macintosh and IBM PC-compatible computers. A video card may need to be installed to use this display with some computers. For more information, see the computer manual.

For more information on what computers or video cards are compatible with the display, see the Specifications chapter.

 **The CRT raster will not always resemble a perfect rectangle.**

CRT tolerances allow for some distortion. Additional distortion can be caused by magnetized metal objects (such as desks or file cabinets). Move the unit to a different location if you notice raster bowing or bent raster edges.

 **Jitter, faint lines, or screen movement can be caused by external interference such as electronic devices and fluorescent lights.**

Fluorescent lights, other monitors, or electronic appliances (such as coffee makers and copy machines) can cause raster distortion. Move the unit to another room or building to help determine if external interference is the source of the problem.

**Note:** If the raster has shifted up/down or right/left only, adjust it using the user controls. However, keep in mind that, if you then move the monitor, you may need to readjust the centering controls.

If the display changes (for better or worse) when you move it to another location, the environment is the source of the problem. Relocate the monitor or move the distortion-causing object.





- ✓ **A maladjusted screen can mimic the symptoms of main deflection board or CRT failures.**

By performing the adjustment procedures, you might determine if one or more of the adjustments is the cause of the problem.

- ✓ **CRTs rarely fail.**

Needless CRT replacement can be prevented by checking display adjustments, checking the possibility of other defective modules, and accepting small imperfections in screen display.

If you have any doubts about whether a CRT is defective, contact Apple Technical Support.





## Symptom Charts

### No Raster

No raster (screen is black); power indicator light on

- 1 Ensure that the display is connected to a known-good video source.
- 2 Adjust the front panel brightness and contrast controls.
- 3 Check the monitor's video cable for breakage or damage. Perform a continuity check to ensure that the video cable is not at fault.
- 4 Slowly adjust the screen control on the flyback transformer to see if the raster appears. If it reappears, perform the "Cutoff and White Balance" procedure in the Adjustments chapter.
- 5 Replace the main deflection board.

No raster; power indicator light off

- 1 Ensure that the display is plugged in and that the power cord is not damaged.
- 2 Replace the main deflection board.

### Video

Display has one predominant color

- 1 Verify that the CRT/video board is connected securely to the CRT socket.
- 2 Inspect the video cable connector (at P301) on the CRT/video board for breakage/continuity. This cable carries the Red, Green, and Blue signals from the main deflection board to the CRT/video board.

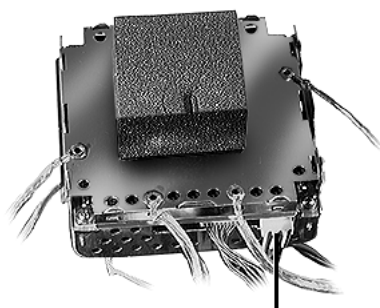

P301

- 3 Perform the "Cutoff and White Balance" procedure in the Adjustments chapter.
- 4 Replace the CRT/video board.
- 5 If you suspect a defective CRT, contact Apple Technical Support.





## Video (Continued)

Areas of the screen  
have blotches of color

- 1 Since this type of problem (purity) is often caused by magnetic fields in the area, place unit in another location to see if symptom disappears, changes in its intensity, or changes location on the screen.
- 2 Turn off the monitor power switch, wait five minutes, then turn it back on. This enables the monitor's internal degaussing coil.
- 3 Severe magnetic field problems require the use of an external degaussing coil. (Degaussing coils can be purchased at most larger electronic parts stores.)

Screen is too bright;  
adjusting Brightness  
control does not  
lower intensity

- 1 Perform the "Cutoff and White Balance" procedure in the Adjustments chapter.
- 2 Replace the CRT/video board.
- 3 Replace the main deflection board.
- 4 If you suspect a defective CRT, contact Apple Technical Support.





## Geometry

- |   |  |
|---|--|
| Raster not centered   | <ol style="list-style-type: none"><li>1 Adjust either or both horizontal center and vertical center controls. See “Geometry” in the Adjustments chapter.</li><li>2 Adjust the horizontal center switch (SW701 on version G only). See “Horizontal Centering” in the Adjustments chapter.</li></ol>   |
| Size of the horizontal and/or vertical raster is incorrect              | <p>Use the appropriate size controls to set the vertical height to 200 mm (7.9 inches) and the horizontal width to 270 mm (10.6 inches). Refer to “Geometry” in the Adjustments chapter.</p>   |
| One or both sides of the raster is bowed                                | <ol style="list-style-type: none"><li>1 To minimize the bowing, perform the “Pincushion” procedure in the Geometry section of the Adjustments chapter. Keep in mind that there is some allowed tolerance and the setting will NOT always be perfect.</li><li>2 <b>Important:</b> As mentioned in step one, some degree of bowing is still considered to be within tolerance. If you have any doubts, contact Apple Technical Support before replacing a board that may not fix the problem.</li><li>3 Replace the main deflection board.</li></ol>   |
| Raster is narrower or wider at the top of the screen than at the bottom | <ol style="list-style-type: none"><li>1 To set the keystone control for optimum screen performance, perform the “Keystone” procedure in the Geometry section of the Adjustments chapter. Keep in mind that there is some allowed tolerance and the setting will NOT always be perfect.</li><li>2 <b>Important:</b> As mentioned in step one, some trapezoidal imperfection is still considered to be within tolerance. If you have any doubts, contact Apple Technical Support before replacing a board that may not fix the problem.</li><li>3 Replace the main deflection board.</li></ol> |





## Sound Problems

Distorted or no sound coming through one speaker

Disconnect the wires to both speakers. Using jumper cables, connect the right speaker wire to the left speaker and the left speaker wire to the right speaker. This will isolate the problem to a defective speaker or a defective main deflection board.

Distorted or no sound in both speakers

- 1 Try another sound source to ensure that you are not using a defective CD or other sound device.
- 2 Replace the main deflection board.

On a Performa 6400, sound comes through Performa subwoofer even though headphones are plugged into headphone jack on front of display

To mute the subwoofer, do any one of the following:

- Keep headphones plugged into headphone jack on front of display, but mute subwoofer using Sound and Displays Control Panel.
- Keep headphones plugged into headphone jack on front of display, but lower volume of subwoofer by turning balance control knob at rear of Performa 6400 fully counterclockwise.
- Plug headphones into headphone jack on front of Performa 6400.
- Plug headphones into headphone jack at rear of Performa 6400.





Take Apart

---

Apple Multiple Scan 15AV  
Display







## Safety Guidelines for Taking Apart the Apple Multiple Scan 15AV Display

**⚠ Warning:** This product contains high voltage and a high-vacuum picture tube. To prevent serious injury, review CRT safety in Bulletins/Safety.

**⚠ Warning:** Never use a grounding wriststrap until after discharging the CRT and setting up an ongoing ground connection.

**Important:** Whenever the housing of the monitor is removed and before replacing a module, you must

- 1 Discharge the CRT and remove the anode cap.
- 2 Establish an ongoing ground by using a cable with alligator clips at both ends. Connect one end to the anode aperture, and connect the other end to the braided ground strap that wraps around the CRT.
- 3 With the CRT discharged and the ongoing ground in place, wear a grounding wriststrap to prevent equipment damage from static electricity.

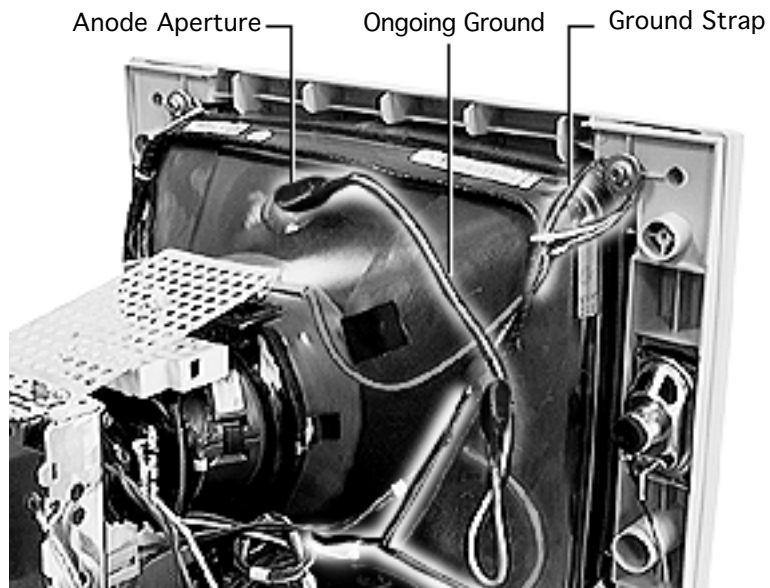
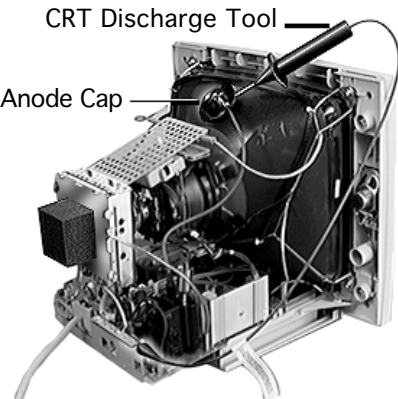



Control Panel Door

## Control Panel Door

No preliminary steps are required before you begin this procedure.





- 1 Position the monitor close to the edge of a table and so that the screen faces you.
- 2 Press down on the center of the door so it flips open.





Control Panel Door

- 3 Grasp each side of the door and pull the door down to release it from its hinges.

**Replacement Note:** Position the door under the bezel so the hinges line up with the bezel contacts. Push the door onto the bezel until it snaps into place.





## Tilt-Swivel Stand

Before you begin, remove the control panel door.

**Note:** Because this procedure requires you to place the monitor face down, you need to remove the control panel door to prevent damaging it.



— Tilt-Swivel Stand



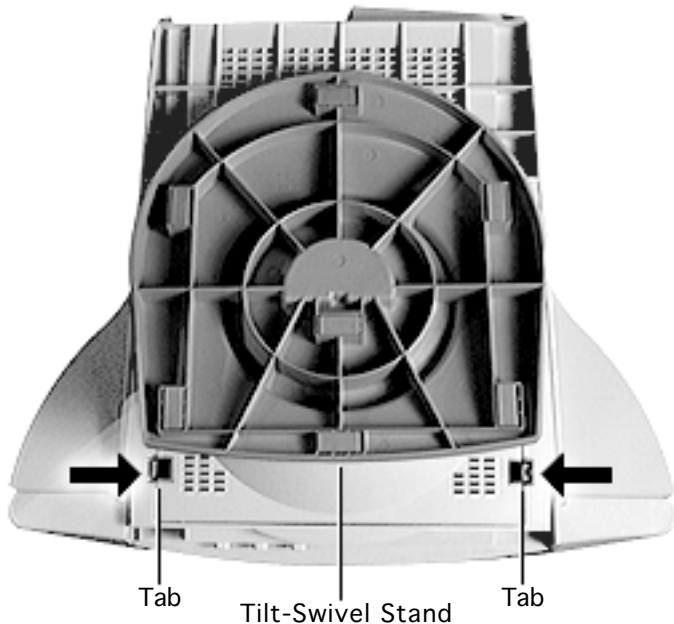

- 1 Place the monitor face-down on a padded surface with the bottom of the stand facing you.
- 2 Press inward on both tabs on the sides of the stand.





Hook      Tilt-Swivel Stand      Hook

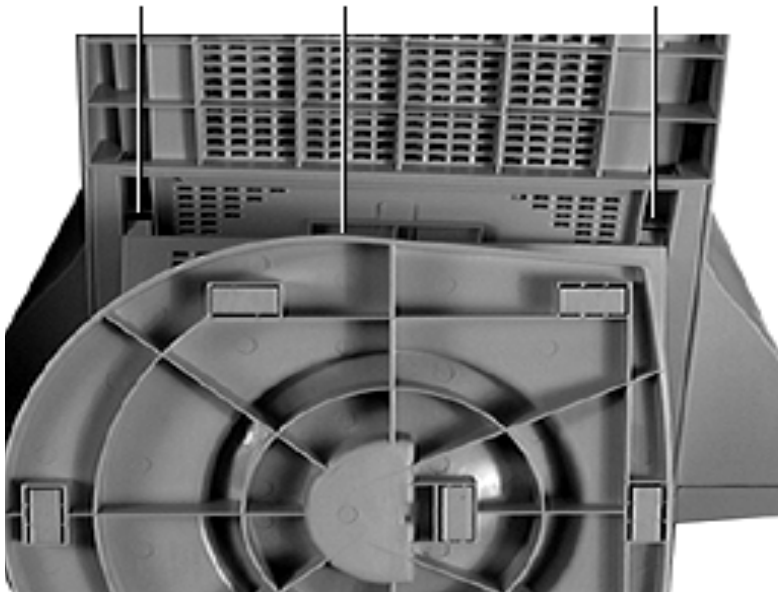

- 3 Tilt the stand upward and off the bottom housing.

**Replacement Note:** With the monitor face down, insert the two hooks on the back of the tilt-swivel stand into the two slots on the bottom housing. Push the stand onto the housing until its tabs snap into place.





## Rear Housing

Before you begin, remove

- Control panel door
- Tilt-swivel stand

**⚠ Warning:** This product contains high voltage and a high-vacuum picture tube. To prevent serious injury, review CRT safety in Bulletins/Safety and read the safety guidelines at the beginning of this chapter.





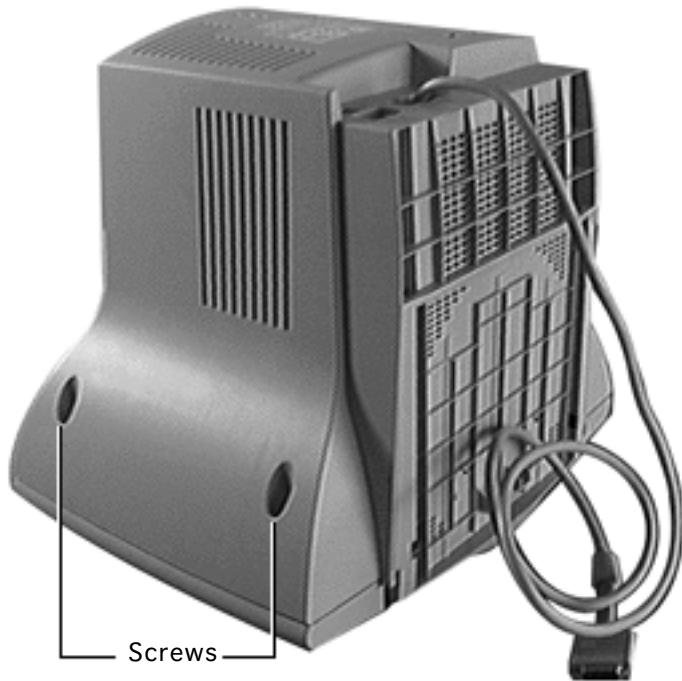

- 1 Place the monitor face-down on a padded surface.
- 2 Remove the four Phillips screws (two on each side).



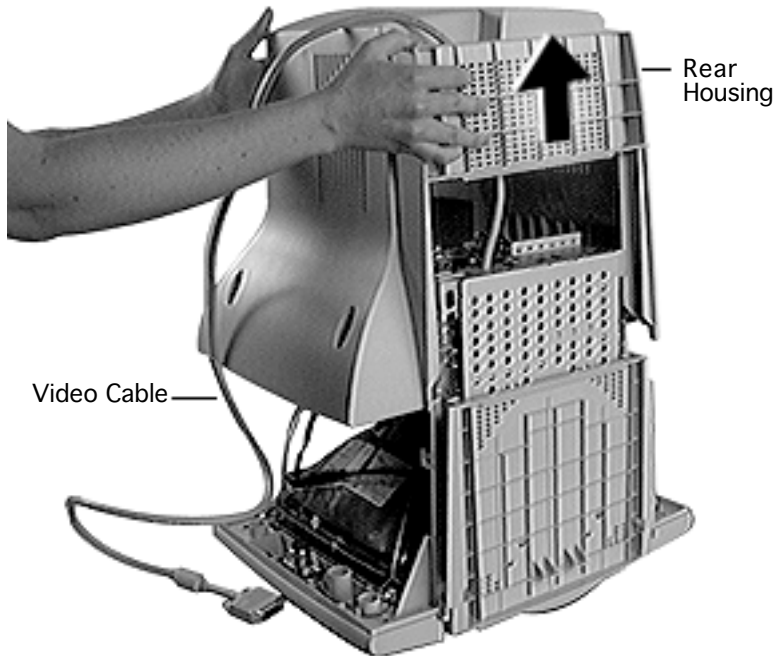

- 3 Lift the rear housing straight off the CRT assembly and route the video cable through the opening in the rear housing.





## Speaker

Before you begin,

- Remove the control panel door
- Remove the tilt-swivel stand
- Remove the rear housing
- Discharge the CRT

**⚠ Warning:** This product contains high voltage and a high-vacuum picture tube. To prevent serious injury, review CRT safety in Bulletins/Safety and read the safety guidelines at the beginning of this chapter.

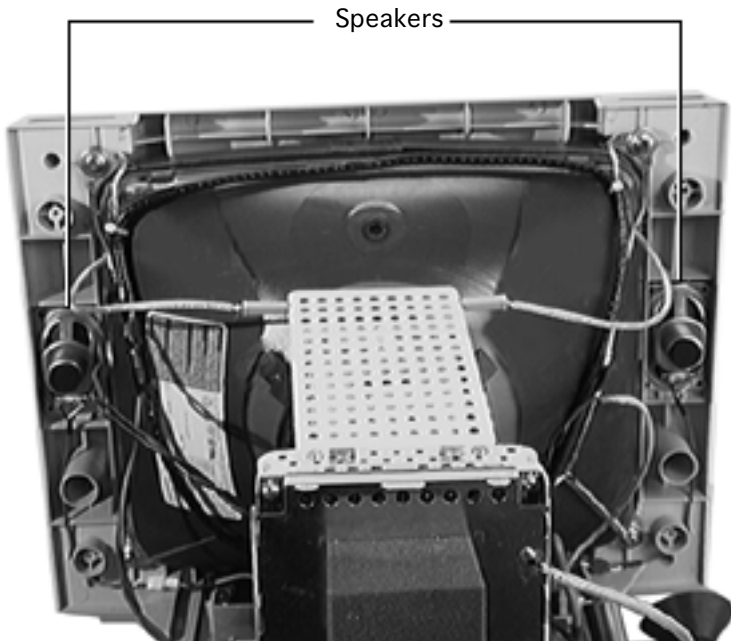

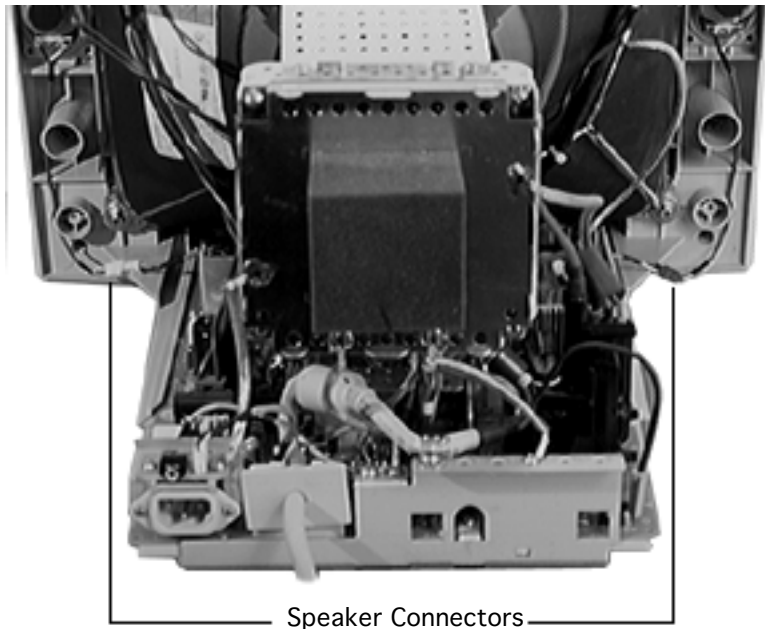

- 1 Locate the inoperative speaker and disconnect the speaker connector near the display's bottom corner, either
  - Red speaker connector on the right
  - White speaker connector on the left





- 2 Remove the speaker wire from its routing channel.

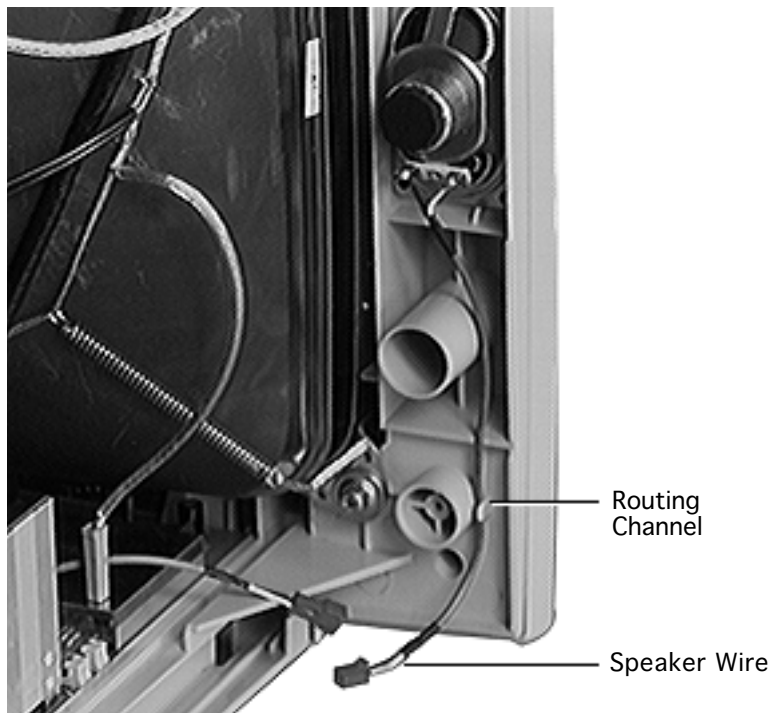

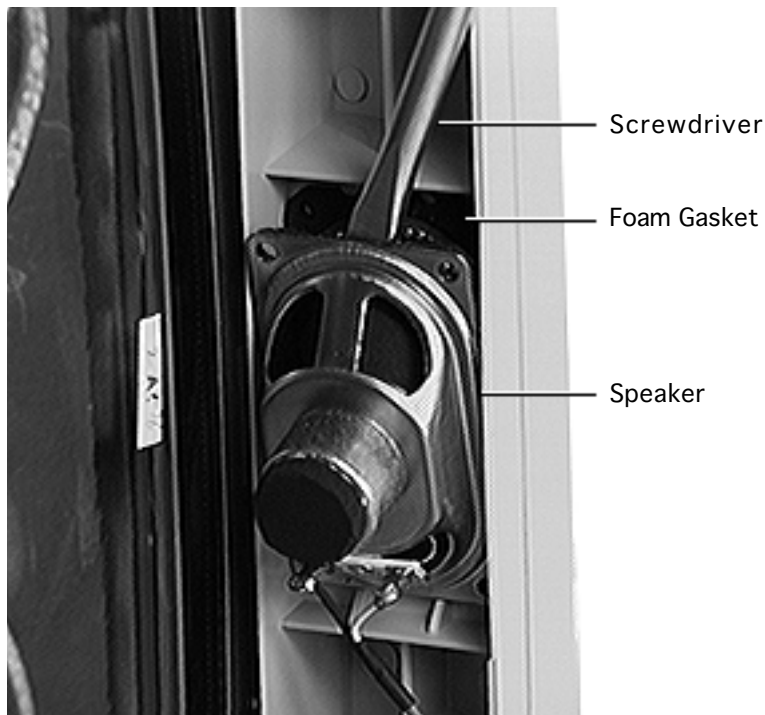

- 3 Use a flat-blade screwdriver to pry off the speaker and its foam gasket from the bezel.
- 4 Lift the speaker from the inside bezel.

**Replacement Note:** When replacing a speaker, verify that the bezel is clean, peel off the foam gasket's adhesive backing, and apply the speaker to the bezel.

The speakers are fully interchangeable, so you can replace a speaker on either side of the bezel.





## Speaker Grilles

Before you begin,

- Remove the control panel door
- Remove the tilt-swivel stand
- Remove the rear housing
- Discharge the CRT

**⚠ Warning:** This product contains high voltage and a high-vacuum picture tube. To prevent serious injury, review CRT safety in Bulletins/Safety and read the safety guidelines at the beginning of this chapter.

Speaker Grille

Speaker Grille

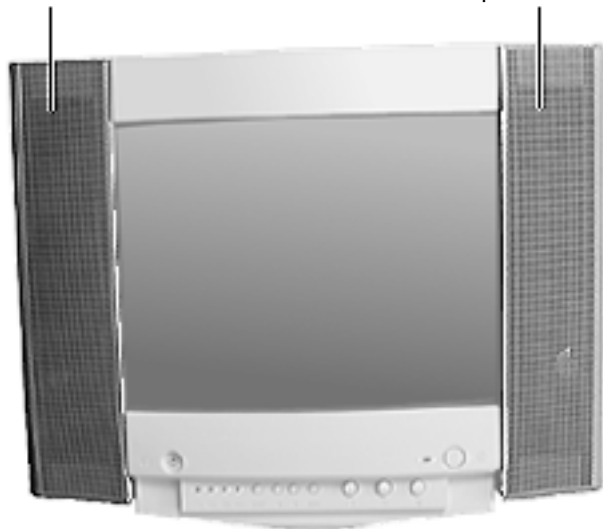

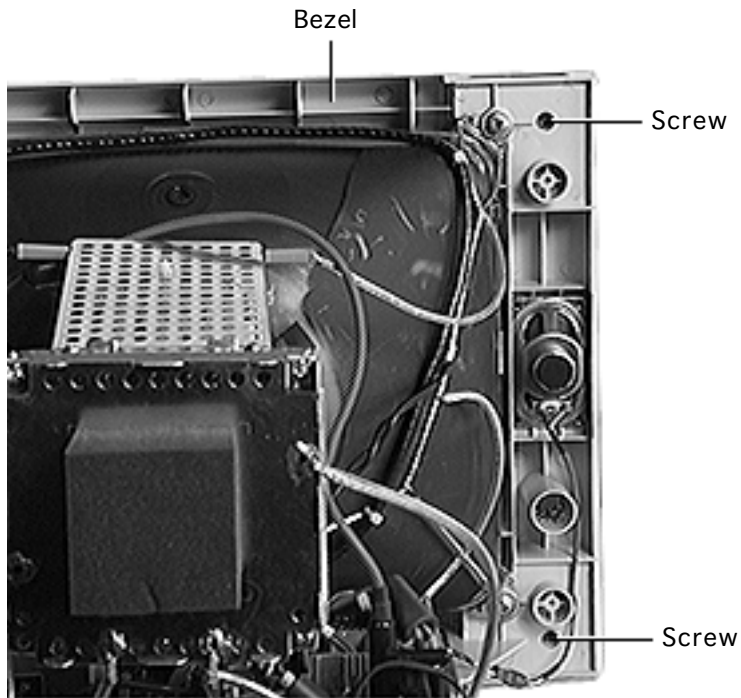

- 1 Remove the two recessed screws at the top and bottom of the inner bezel sides.

**Caution:** Do not remove the CRT corner screws.





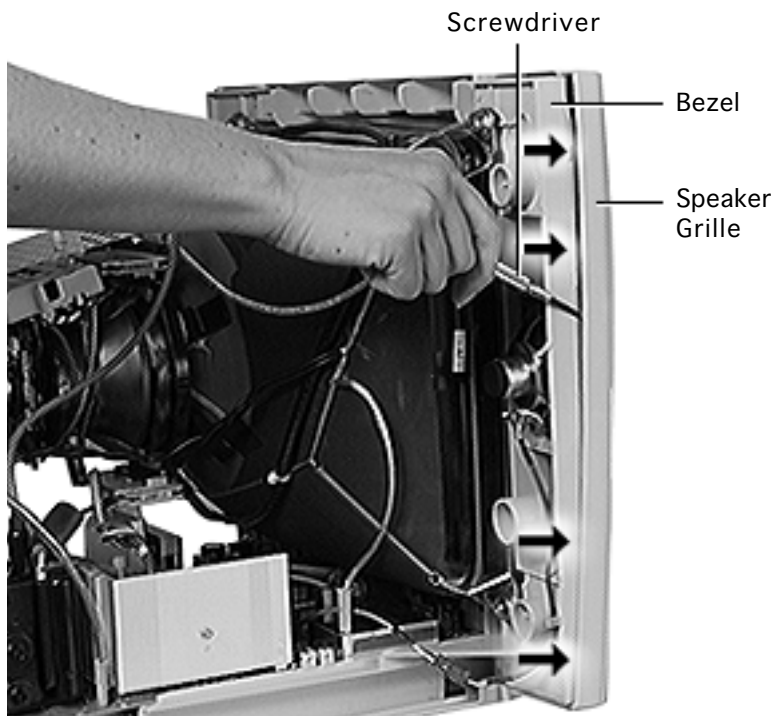

- 2 Insert a small flat-blade screwdriver between the outside speaker grille and bezel. Pry off the grille in four places to release the four side tabs.



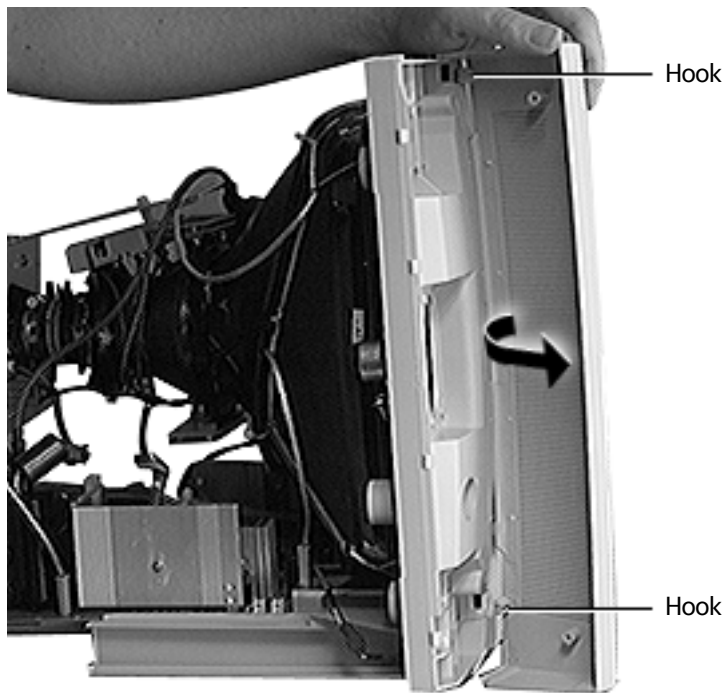

- 3 Gently tilt the speaker grille toward the display face to release it from the bezel hooks.
- 4 Repeat steps 1 through 3 for the other speaker grille.

**Replacement Note:** The left and right speaker grilles come as a pair and are not interchangeable.





## Sound In Board

Before you begin,

- Remove the control panel door
- Remove the tilt-swivel stand
- Remove the rear housing
- Discharge the CRT

**⚠ Warning:** This product contains high voltage and a high-vacuum picture tube. To prevent serious injury, review CRT safety in Bulletins/Safety and read the safety guidelines at the beginning of this chapter.

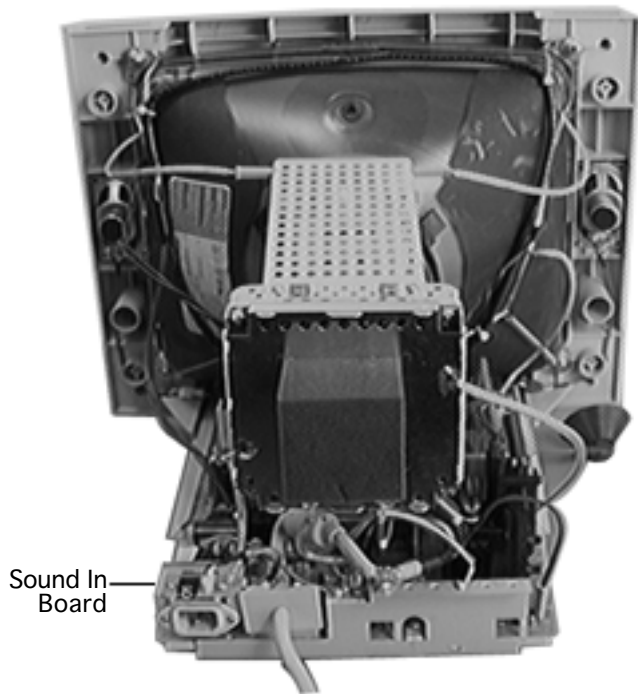

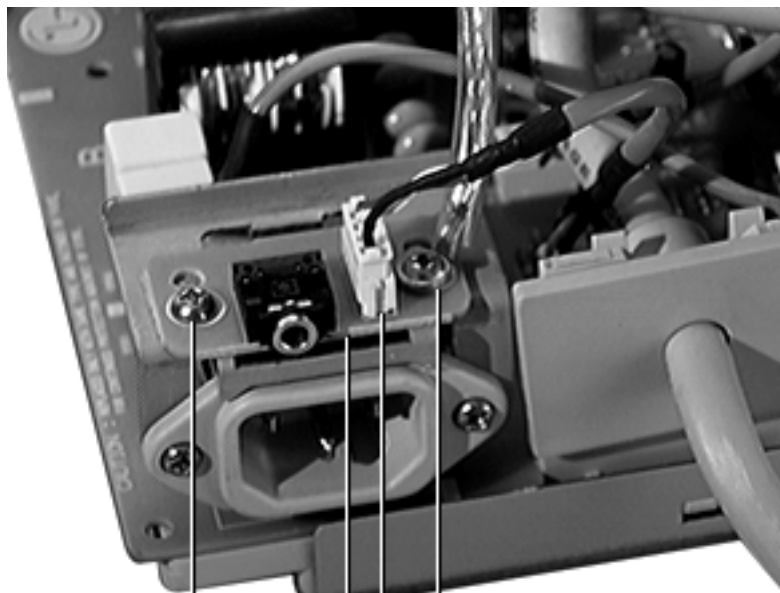

Screw    Sound In Board    P156    Screw

- 1 Remove
  - Two screws
  - P156 connector
- 2 Lift the board off the metal bracket.



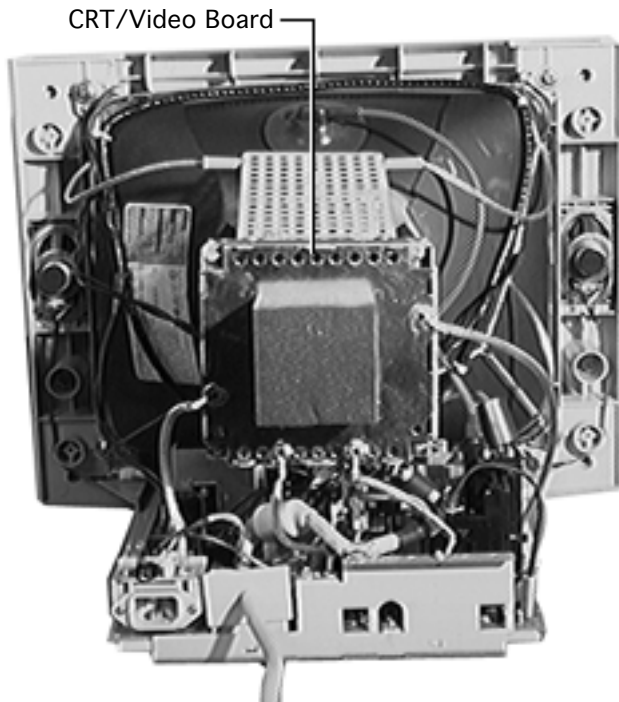

## CRT/Video Board

Before you begin,

- Remove the control panel door
- Remove the tilt-swivel stand
- Remove the rear housing
- Discharge the CRT

**⚠ Warning:** This product contains high voltage and a high-vacuum picture tube. To prevent serious injury, review CRT safety in Bulletins/Safety and read the safety guidelines at the beginning of this chapter.





Ground Cable CRT Shield Ground Cable

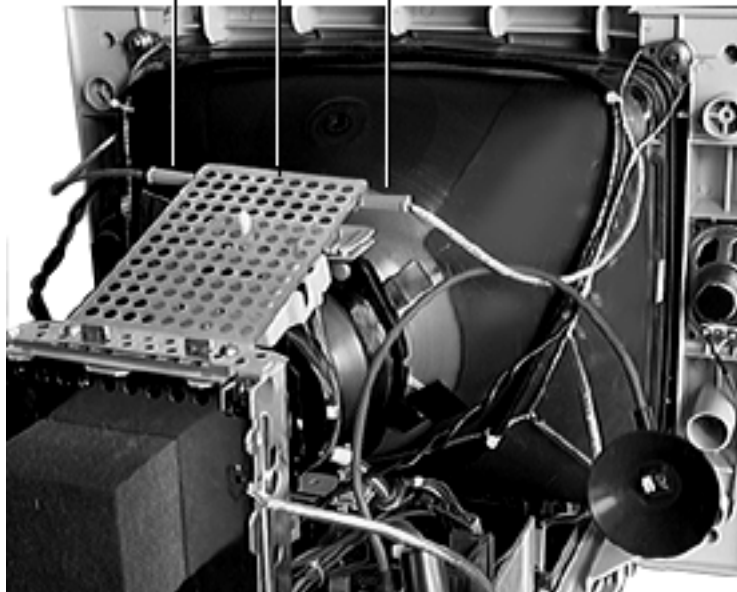

**Caution:** When disconnecting cables from the CRT/video board, be careful not to apply excessive pressure on the neck of the CRT.

- 1 Disconnect the two braided CRT ground cables located on both sides of the CRT shield.



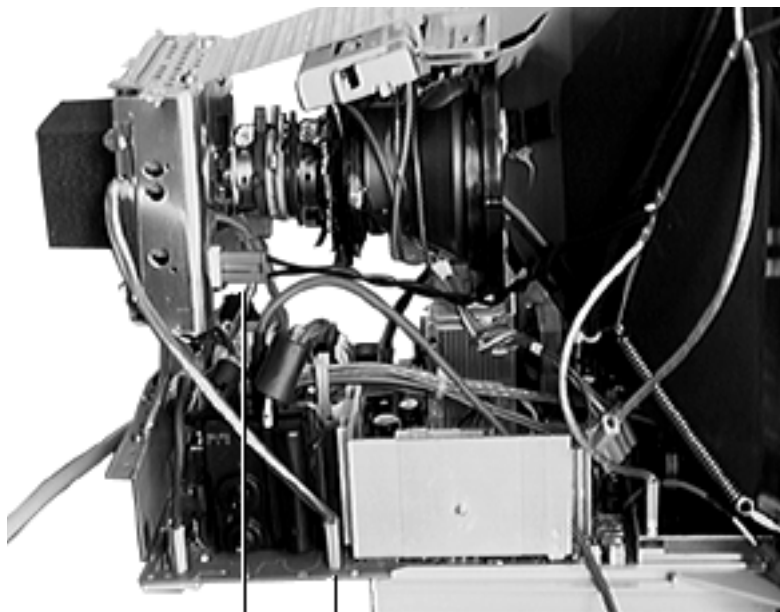

Two-Wire  
Connector

Braided Cable at E2

- 2 From the side of the CRT assembly, disconnect
  - Two-wire connector behind CRT/video board
  - Braided cable at E2 to the right of the flyback transformer on the main deflection board



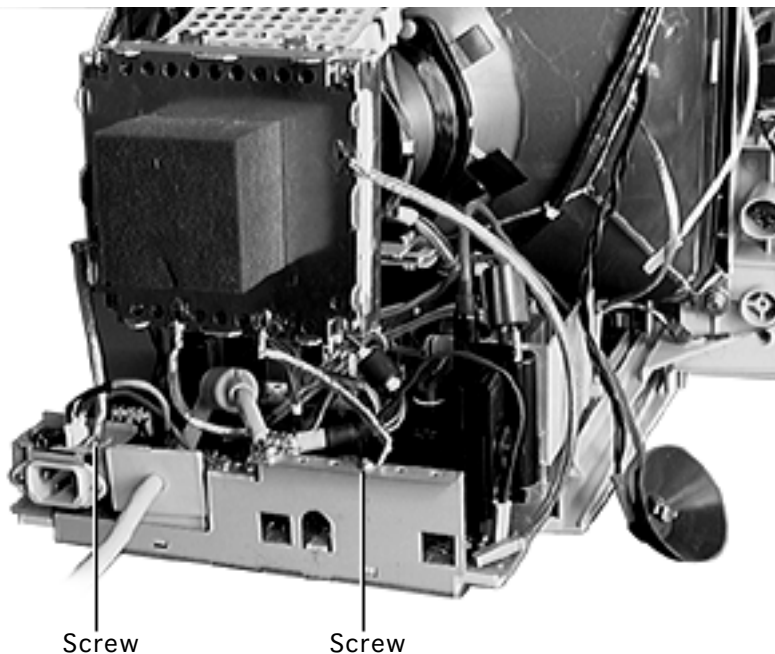

- 3 From the back of the CRT assembly, remove
- Phillips screw that connects the braided cable to the sound in board
  - Phillips screw that attaches the braided cable to the back panel flange





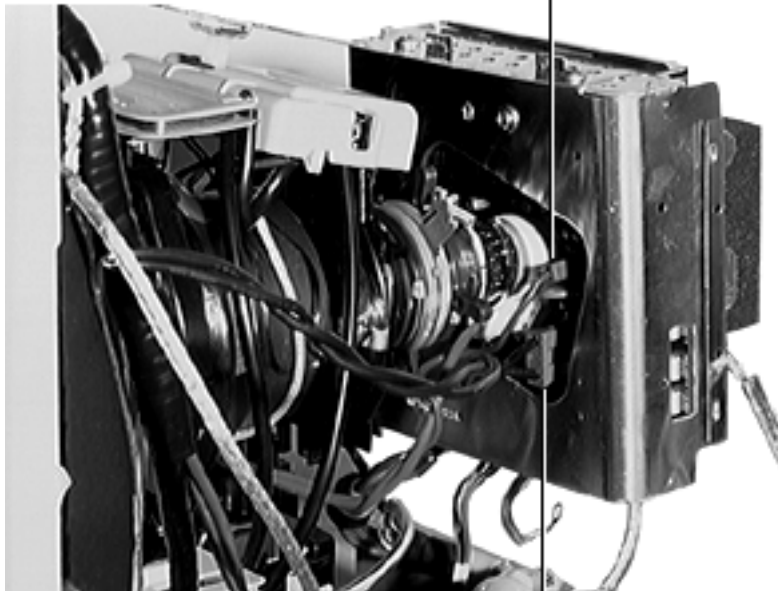

Red Wire at P304

Two-Wire Connector at P305

- 4 From the side of the CRT assembly, disconnect
  - Red wire with the gray connector on the CRT/video board at P304
  - Black two-wire connector on the CRT/video board at P305



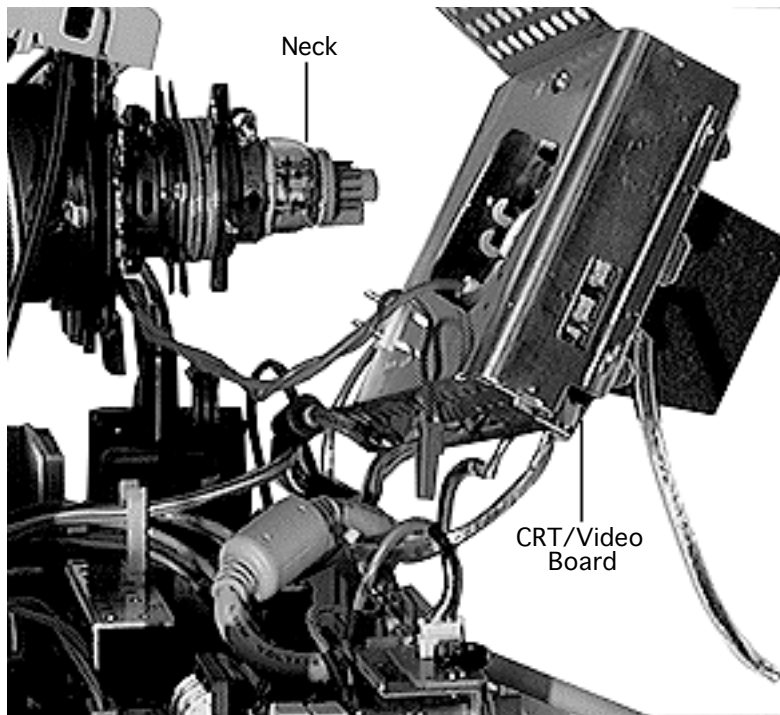

- 5 **Caution:** Twisting, bending, or applying force to the CRT/video board could damage the neck of the CRT.  
  
With a gentle side-to-side motion, ease the CRT/video board off the neck of the CRT until it clears the neck pins.
- 6 With some wires still attached, set the CRT/video board on the table.



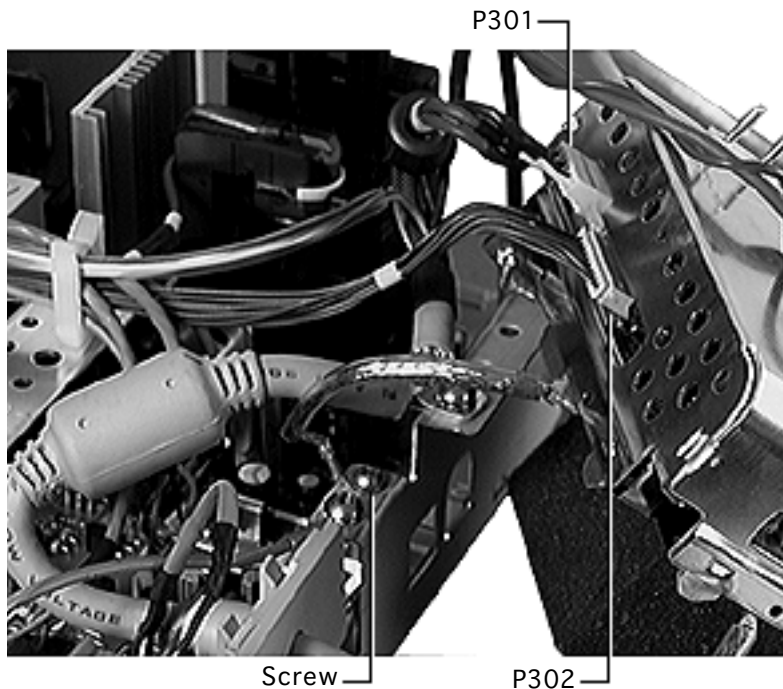

- 7 Using a Phillips screwdriver, remove the screw holding the braided cable to the back panel flange.
- 8 Disconnect
  - Connector P302
  - Connector P301



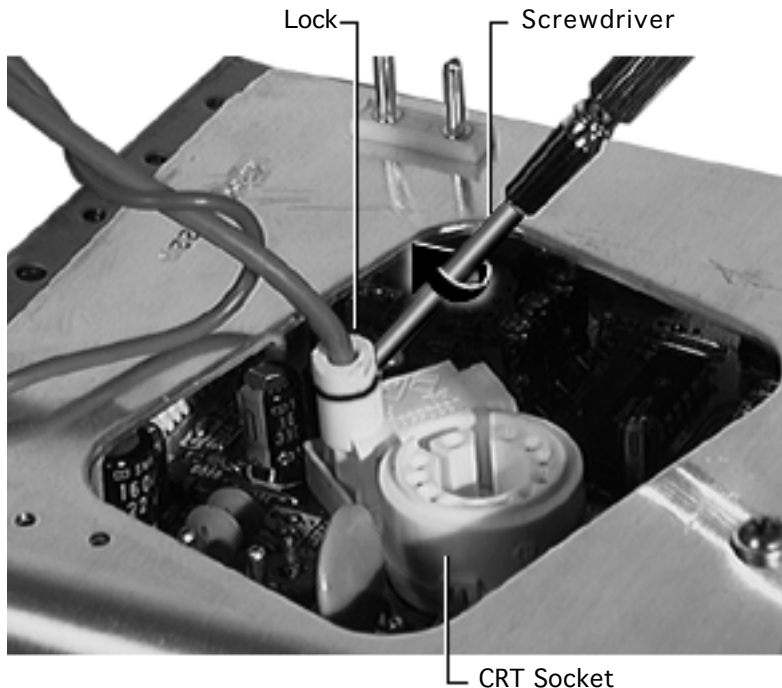

- 9 Use a flat-blade jeweler's screwdriver to gently pry up the wire lock (about one to two millimeters) from the CRT socket base.



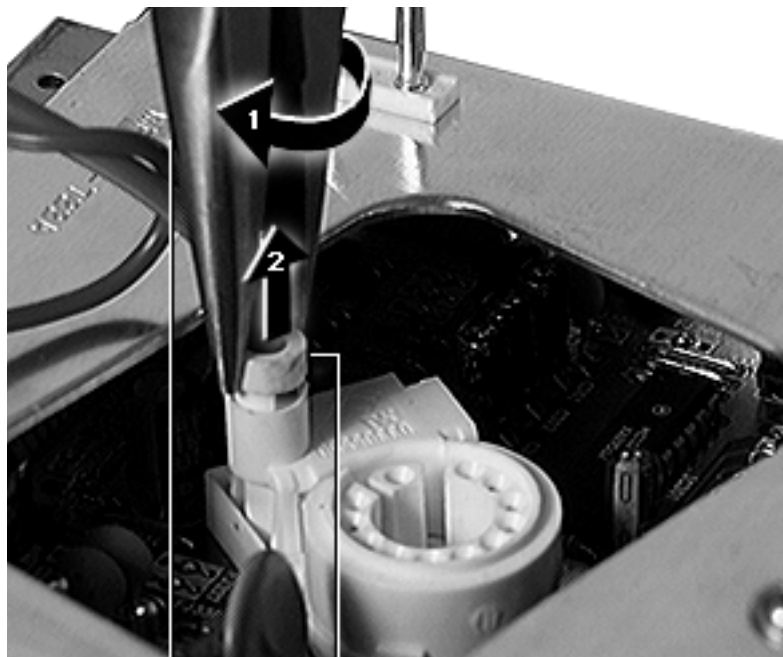

10 Using needlenose pliers, firmly grasp the lock and twist it in a clockwise direction (about one-eighth of a turn) while pulling the lock straight up.

Needlenose Pliers    Lock



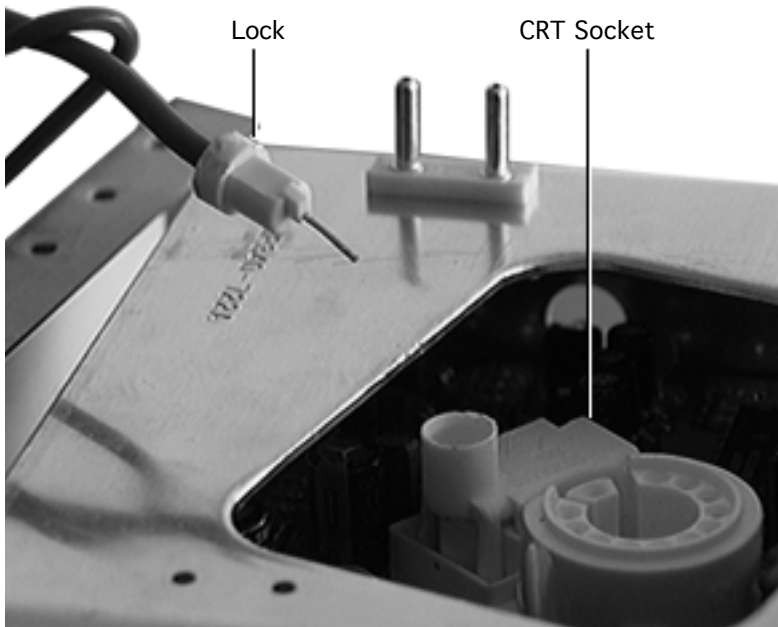

11 Pull the wire lock and wire from the CRT socket.

Because the lock fits loosely over the wire, slightly bend the wire so the lock cannot slide off.

**Replacement Note:** Before securing the lock inside the CRT socket, ensure the end of the wire is straight. With the lock attached, push the wire straight down as far as it will go. Then secure the lock in the socket with a counterclockwise turn.





Screw      Shield      Screw

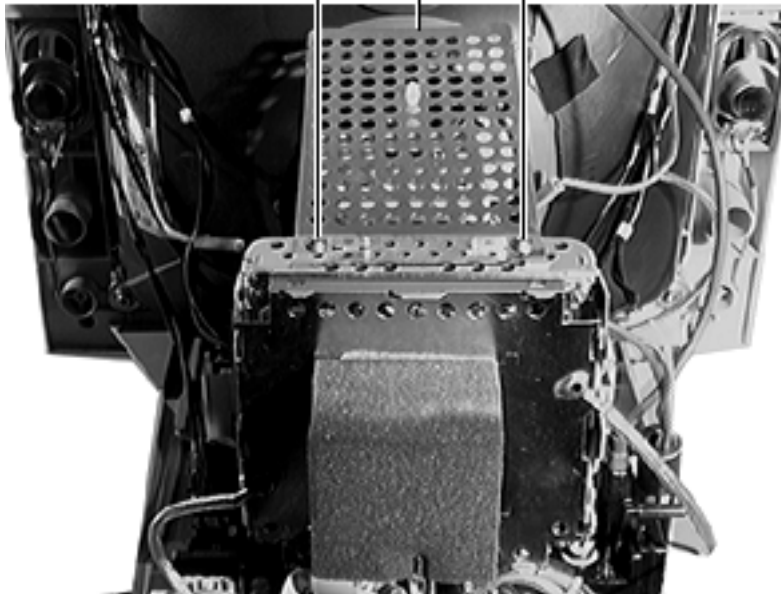

**Replacement Note:** Before returning a CRT/video board for replacement, remove and retain the shield so you can attach it to the replacement board.

Remove the two Phillips screws that secure the shield onto the CRT/video board.



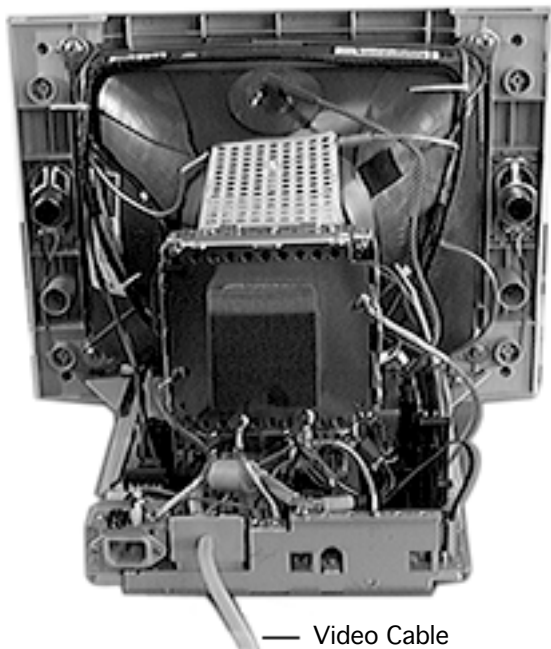

## Video Cable

Before you begin,

- Remove the control panel door
- Remove the tilt-swivel stand
- Remove the rear housing
- Discharge the CRT

**⚠ Warning:** This product contains high voltage and a high-vacuum picture tube. To prevent serious injury, review CRT safety in Bulletins/Safety and read the safety guidelines at the beginning of this chapter.





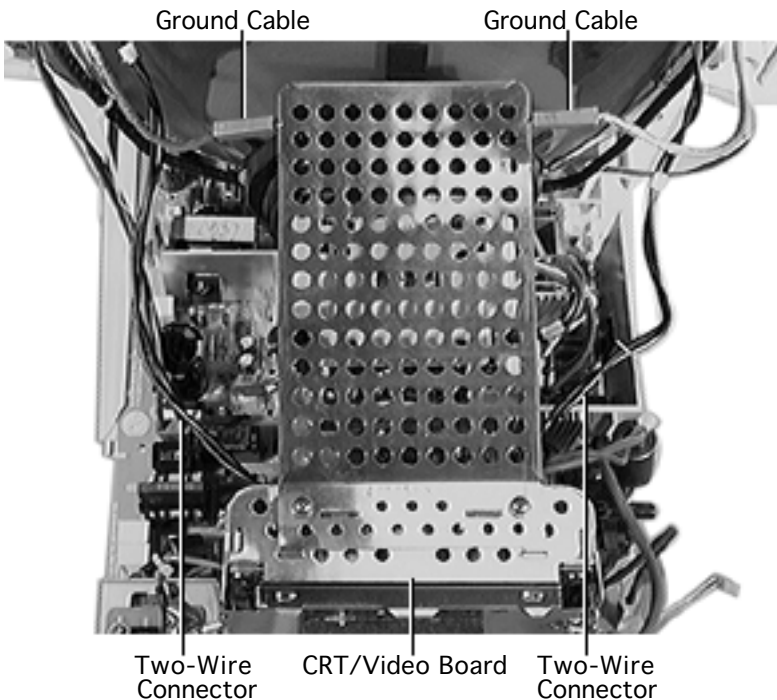

**Caution:** Twisting, bending, or applying force to the CRT/video board could damage the neck of the CRT.

- 1 Disconnect
  - Two braided CRT ground cables from the CRT shield
  - Two two-wire connectors from the CRT/video board
- 2 With a gentle side-to-side motion, ease the CRT/video board off the neck of the CRT until it clears the neck pins.



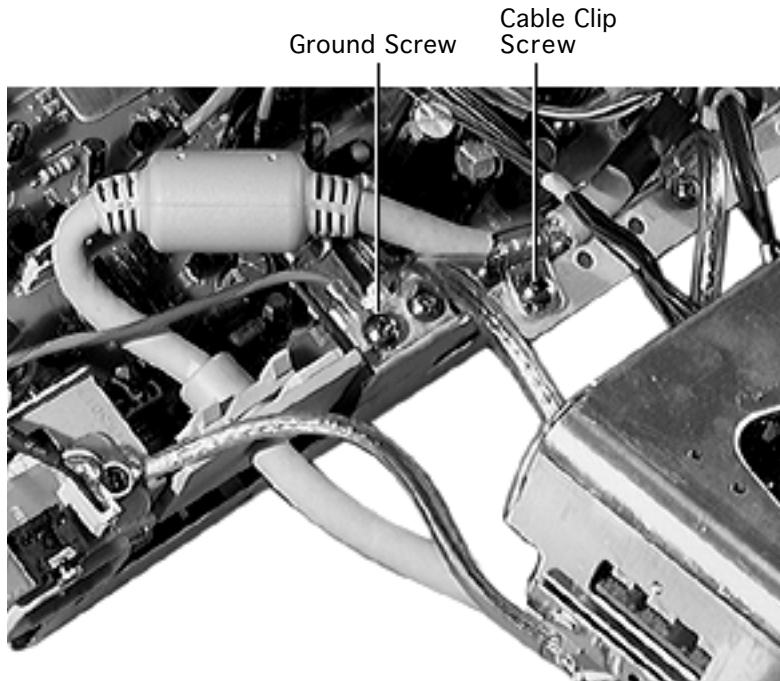

- 3 With some wires still attached, move the CRT/ video board so that you can reach the back panel screws.
- 4 Remove
  - Phillips ground screw and lock washer
  - Phillips screw and lock washer at the cable clip



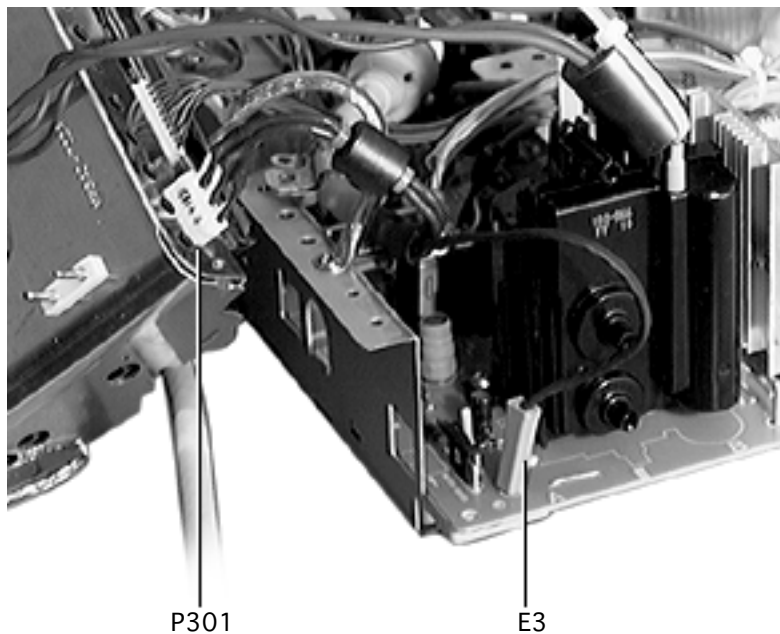

- 5 Disconnect
- Connector P301
  - Pin E3



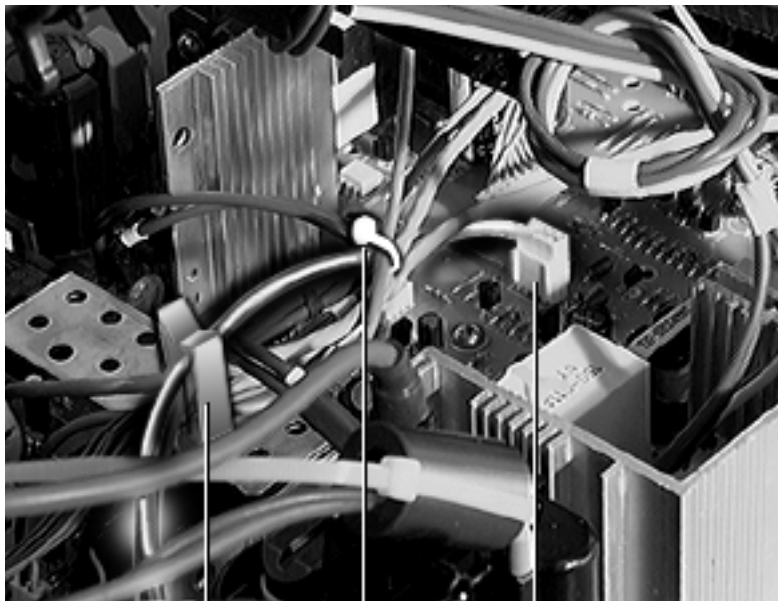

Cable Clamp

Tie Wrap

P401

- 6 Disconnect P401 from the center of the main deflection board.
- 7 Cut the tie wrap that holds the P401 cable.
- 8 Remove the cable from the cable clamp.

**Replacement Note:**

Secure the P401 cable by routing it through the cable clamp and using a new wire tie wrap.



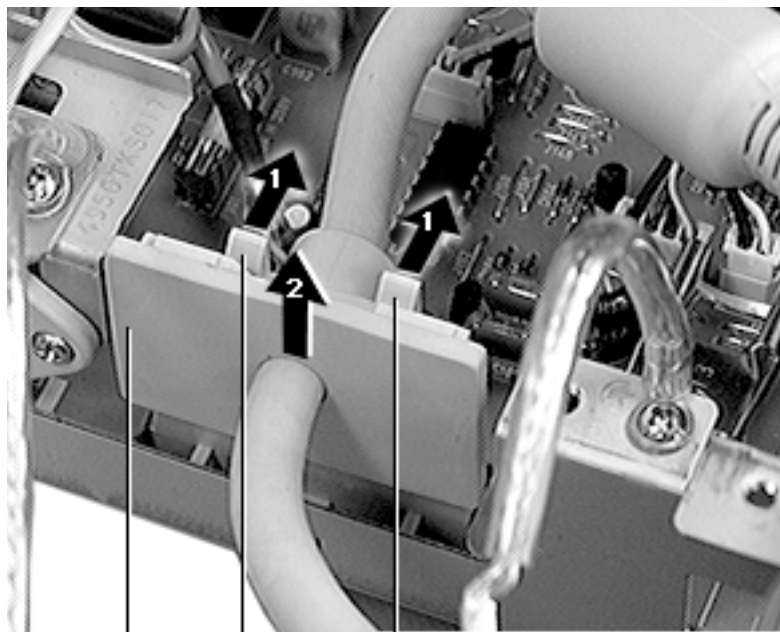

Video Cable  
Strain Relief

Hook

Hook

- 9 At the video cable strain relief, press the two hooks forward and pull up on the video cable strain relief to release it from the slot.





## Main Deflection Board

Before you begin,

- Remove the control panel door
- Remove the tilt-swivel stand
- Remove the rear housing
- Discharge the CRT and disconnect the anode cap
- Remove the CRT/video board

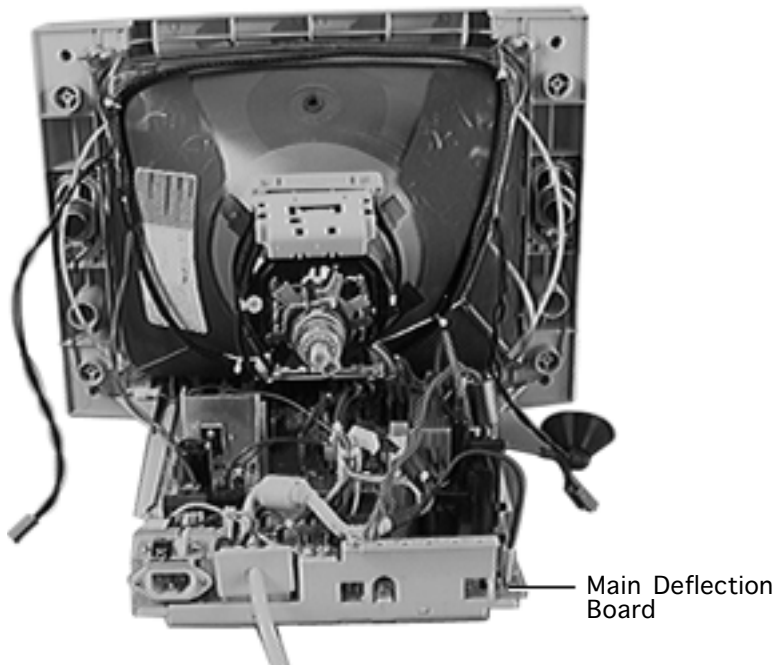

Main Deflection Board



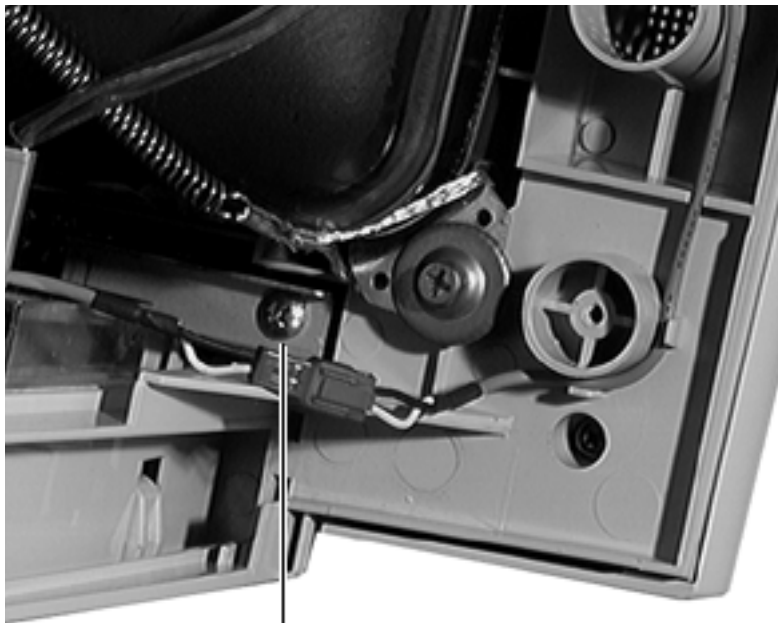

Screw

**⚠ Warning:** This product contains high voltage and a high-vacuum picture tube. To prevent serious injury, review CRT safety in Bulletins/Safety and read the safety guidelines at the beginning of this chapter.

- 1 Remove the Phillips screw from the chassis bracket (next to the bottom right CRT corner screw).



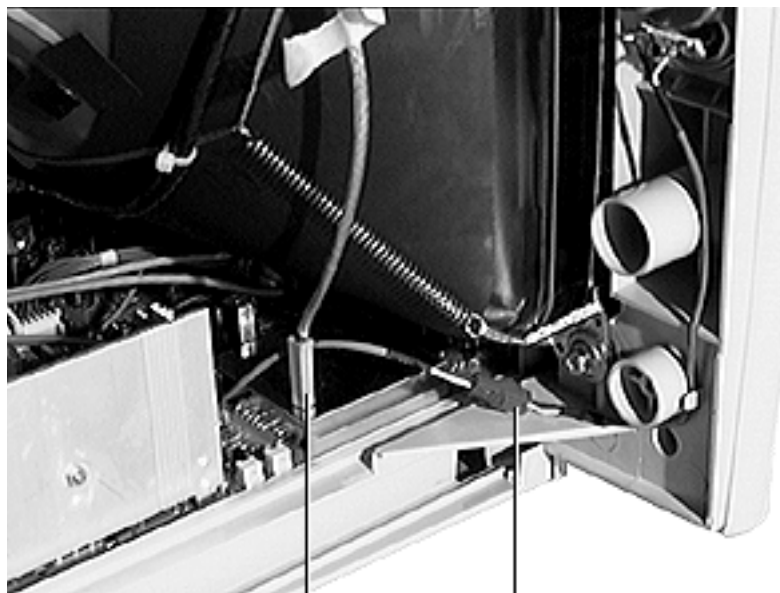

Ground Pin

Speaker  
Connector

- 2 Disconnect
  - Speaker connector
  - Ground pin







- 3 Disconnect the CRT yoke wire at P701.

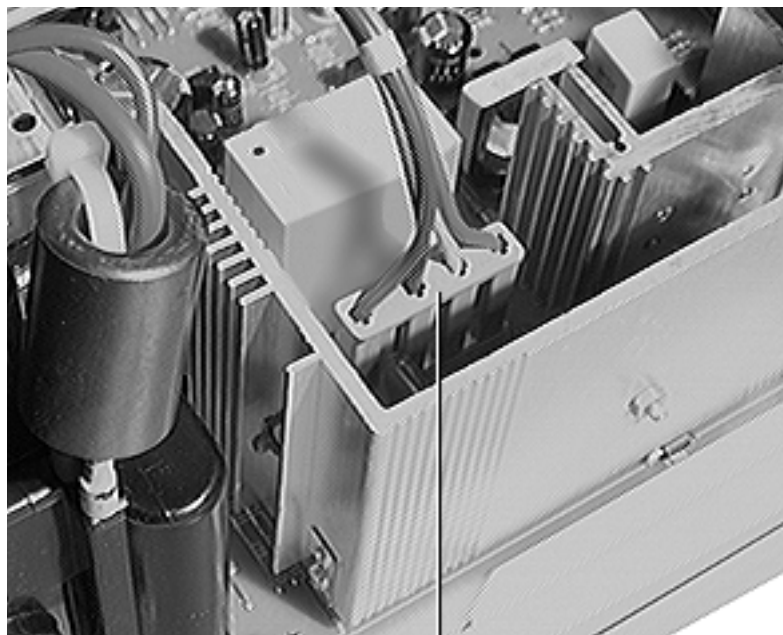

P701



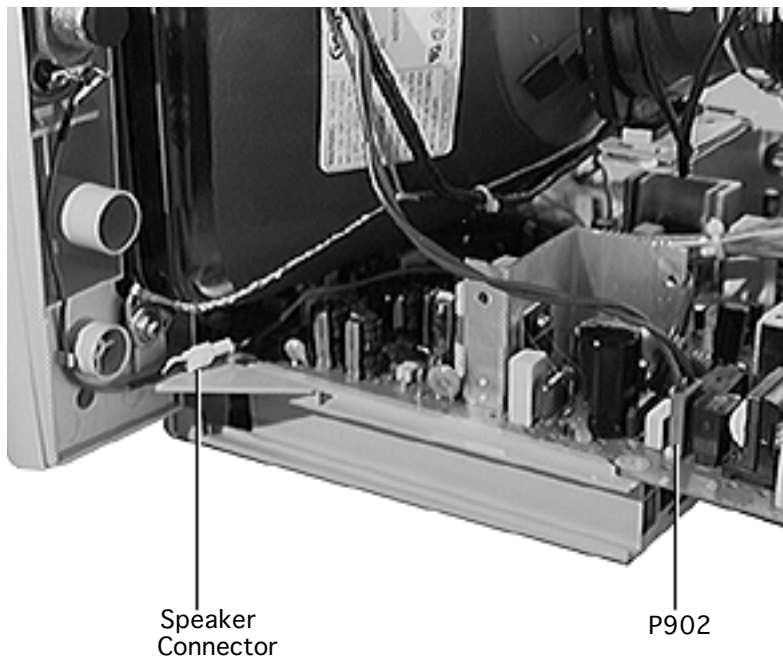

- 4 Disconnect
- Speaker connector
  - Degaussing coil at P902



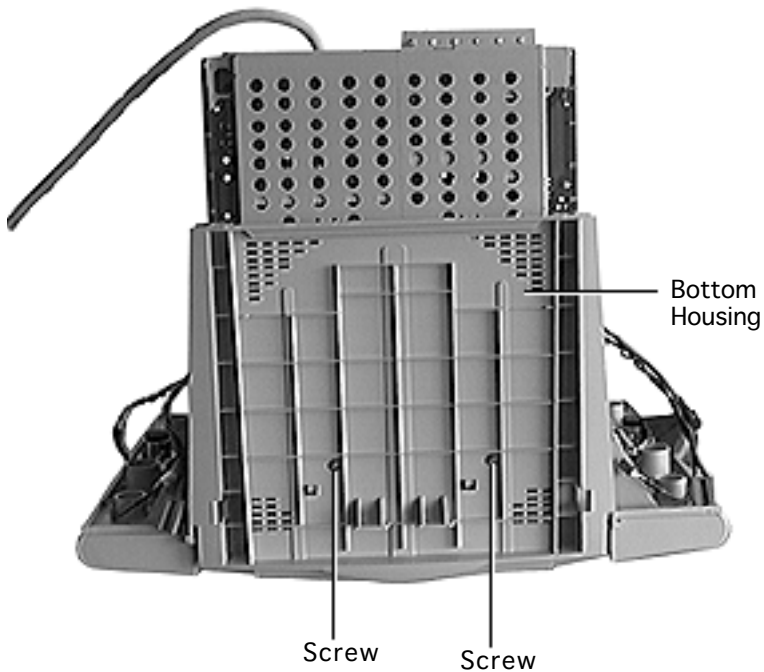

- 5 Place the monitor face-down on a padded surface.
- 6 Remove the two Phillips screws from the bottom housing.



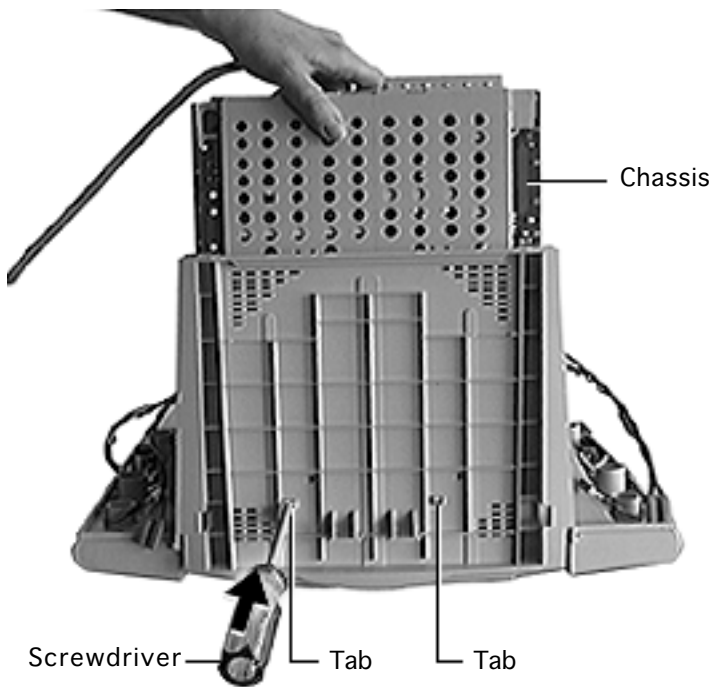

- 7 While grasping the end of the main deflection board chassis with one hand, use a flat-blade screwdriver to press in on one of the two tabs on the bottom of the bezel assembly.

Press in on the other tab, and slide the main deflection board straight up and off of the CRT assembly.

- 8 Refer to this chapter to remove the sound in board, video cable, and control panel board that



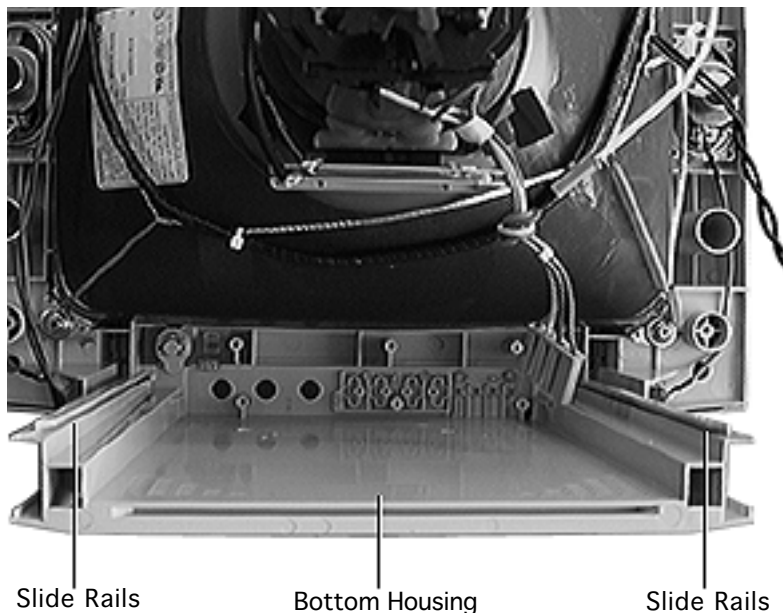

are attached to the main deflection board chassis.

**Replacement Note:** With the control panel board secured to the replacement main deflection board, align the side edges of the main deflection board with the two slide rails on the bottom housing.

Ensure no cables get pinched as you slide the board into place. With the board in place, be sure to reconnect all cables including the anode cap.





## Control Panel Board

Before you begin,

- Remove the control panel door
- Remove the tilt-swivel stand
- Remove the rear housing
- Discharge the CRT
- Remove the CRT/video board
- Remove the main deflection board

**⚠ Warning:** This product contains high voltage and a high-vacuum picture tube.

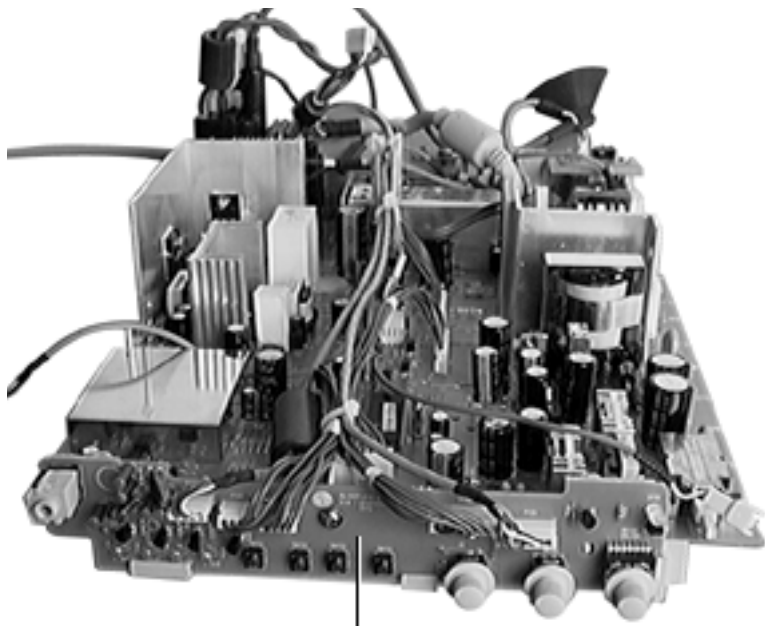

Control Panel Board



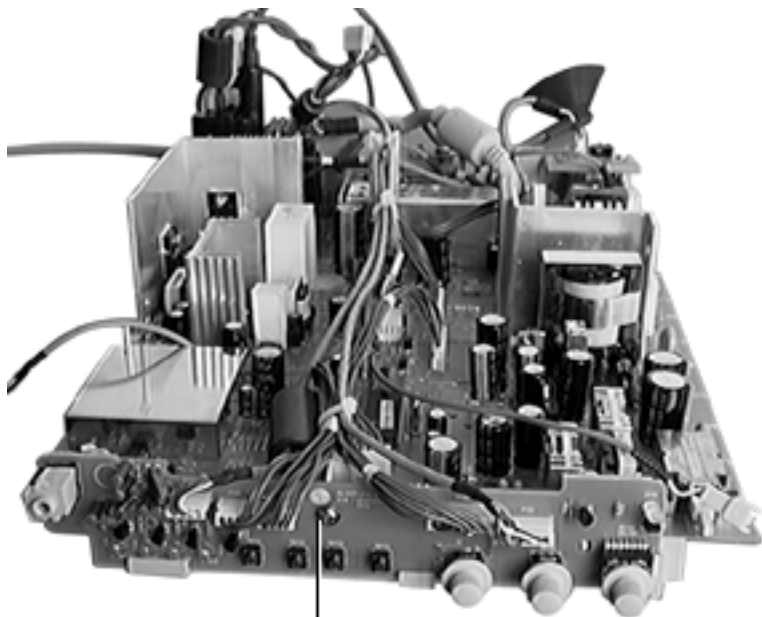

Screw

To prevent serious injury, review CRT safety in Bulletins/Safety and read the safety guidelines at the beginning of this chapter.

- 1 Remove the Phillips screw.





- 2 Slightly tilt the control panel board forward, and slide it out of the plastic holder.

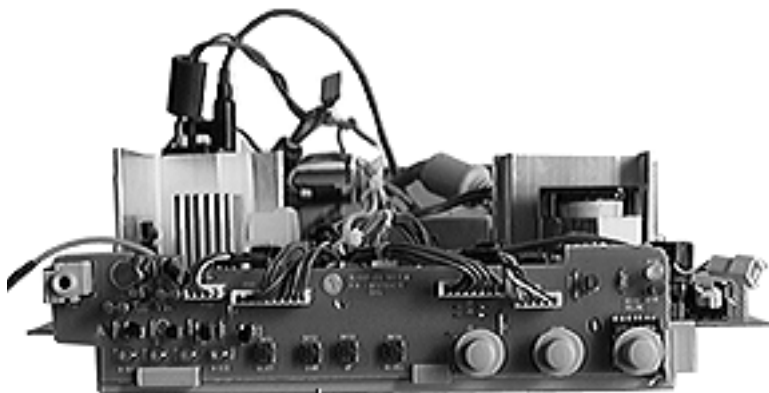

Holder





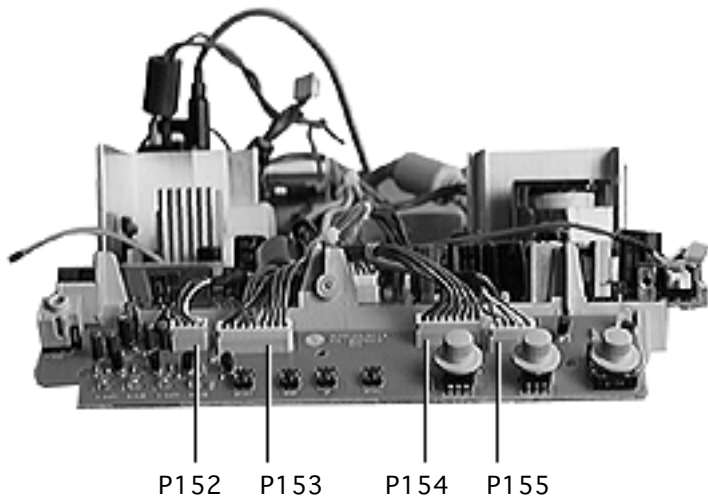

3 Disconnect the following four connectors:

- P152
- P153
- P154
- P155

**Replacement Note:** Remove and retain the three knobs from the control panel board so you can attach them to the replacement board.





Power Switch

## Power Switch

Before you begin,

- Remove the control panel door
- Remove the tilt-swivel stand
- Remove the rear housing
- Discharge the CRT
- Remove the CRT/video board
- Remove the main deflection board

**⚠ Warning:** This product contains high voltage and a high-vacuum picture tube. To prevent serious injury,



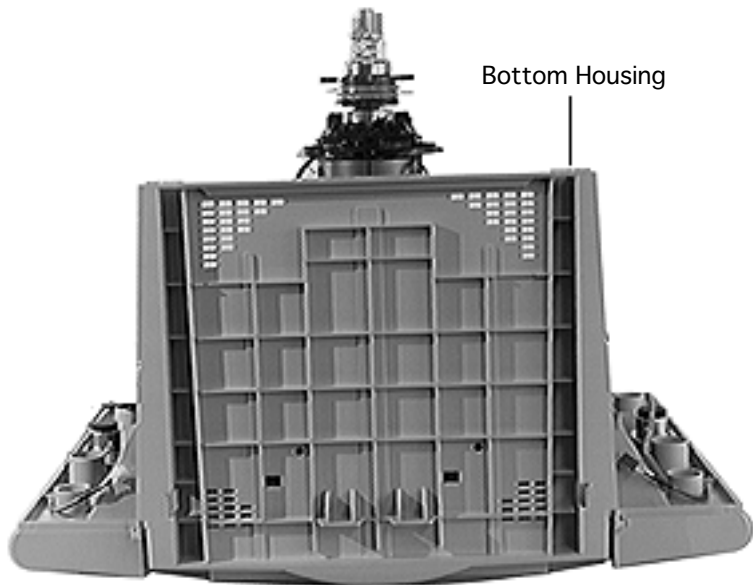

review CRT safety in Bulletins/Safety and read the safety guidelines at the beginning of this chapter.

- 1 Place the monitor face down on a padded surface so the bottom housing faces you.



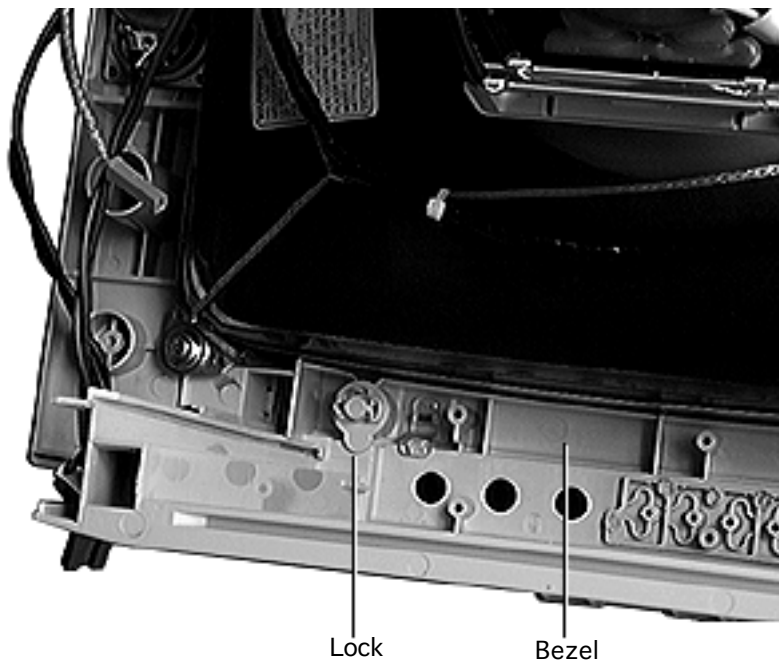

- 2 Locate the power switch lock inside the bezel.



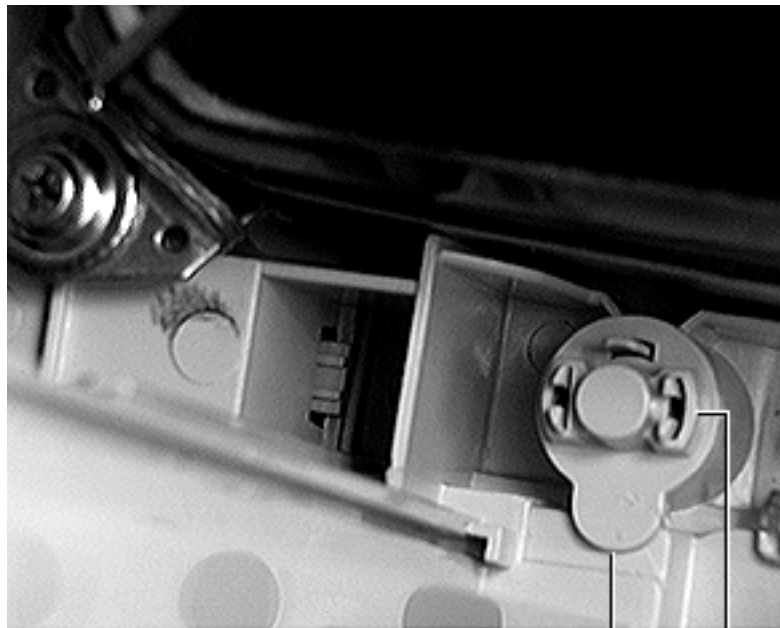

Tab

Lock

- 3 Use needlenose pliers to grasp the lower tab of the power switch lock. Pull up the lock as far as it will go.



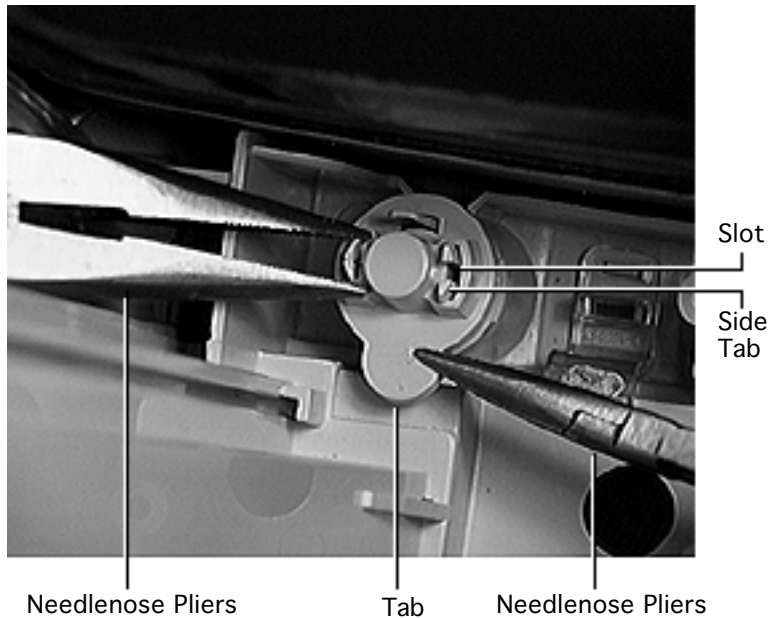

- 4 While holding the lock tab up, use a second pair of needlenose pliers to pinch the two side tabs so that they fit through the slot in the lock.

Repeat for the other side tabs.





- 5 Pull the lock off of the power switch and spring.

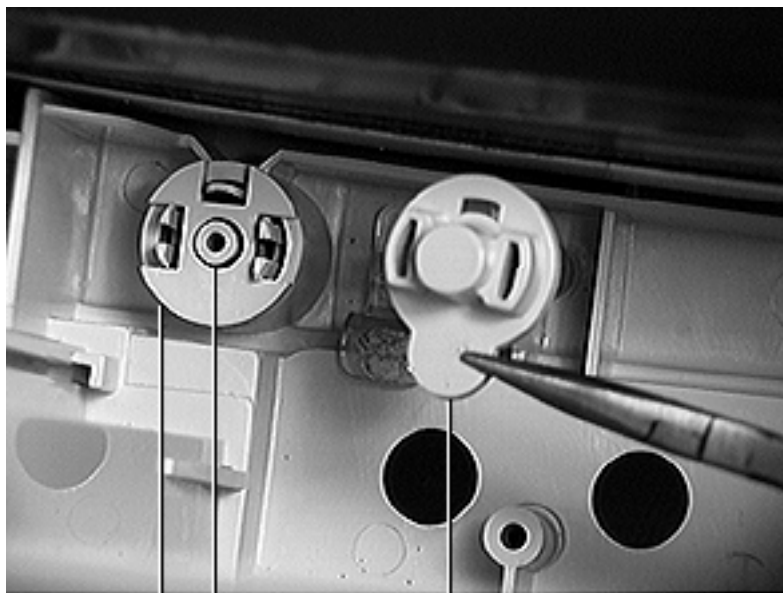

Power  
Switch

Spring

Lock





- 6 Tilt up the CRT assembly to pull out the power switch and spring from the front side of the bezel.

The power switch assembly consists of the three pieces shown here.



Lock



Spring

Power Switch







## Front Bezel

Before you begin,

- Remove the control panel door
- Remove the tilt-swivel stand
- Remove the rear housing
- Discharge the CRT
- Remove the CRT/video board
- Remove the main deflection board
- Remove the speakers
- Remove the power switch



Front Bezel



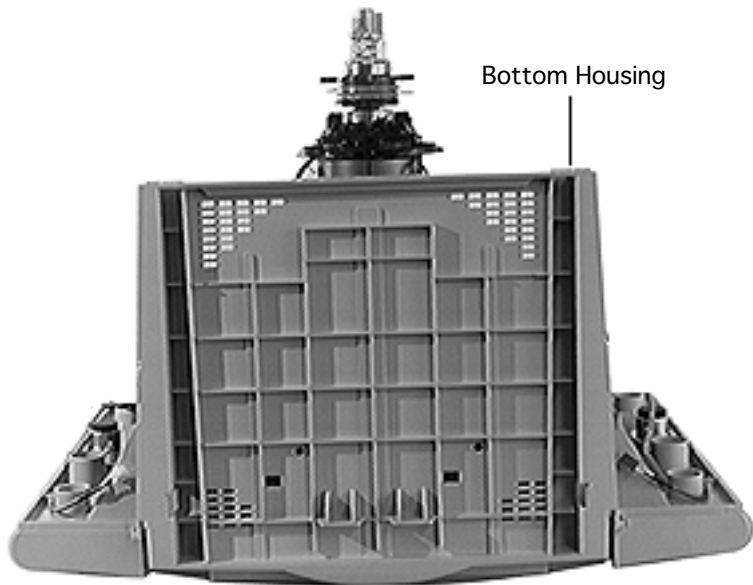

**⚠ Warning:** This product contains high voltage and a high-vacuum picture tube. To prevent serious injury, review CRT safety in Bulletins/Safety and read the safety guidelines at the beginning of this chapter.

- 1 Place the monitor face down on a padded surface so the bottom housing faces you.



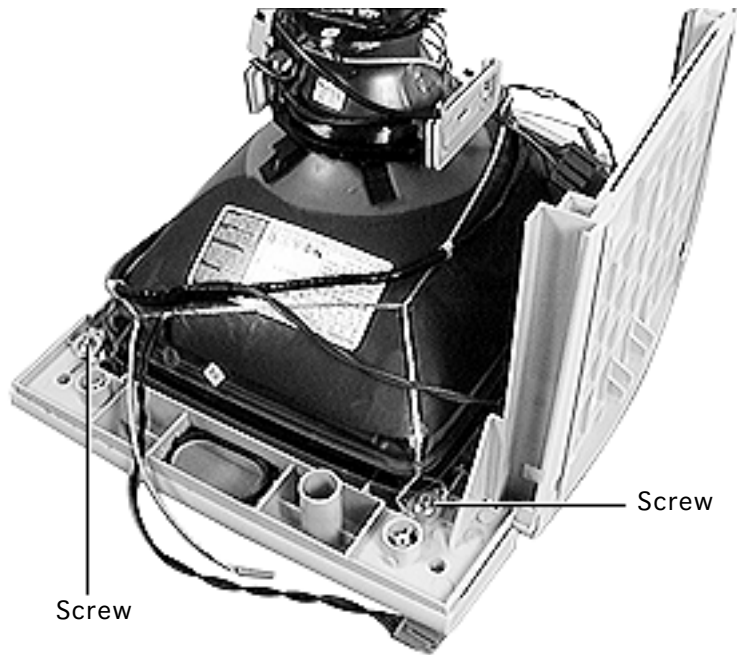

- 2 Using a Phillips screwdriver, remove the four CRT corner screws and washers (two on each side).



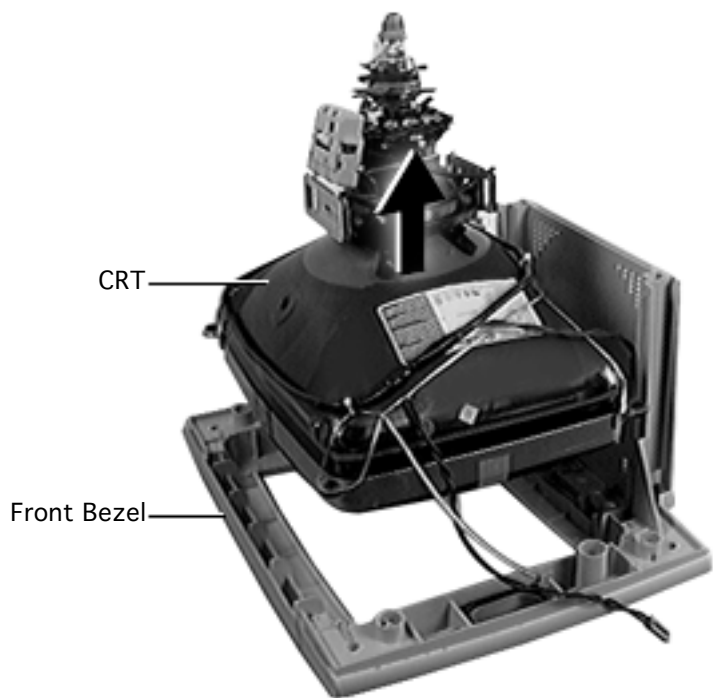

- 3 Using both hands, lift the CRT off of the front bezel.





## Adjustments

---

Apple Multiple Scan 15AV  
Display





## Power Supply Voltage

Before you begin, refer to the Take Apart chapter to remove the rear housing.

**⚠ Warning:** This product contains high voltage and a high-vacuum picture tube. To prevent serious injury, review CRT safety in Bulletins/Safety.

**Note:** Perform the power supply voltage adjustment whenever the main deflection board is replaced.

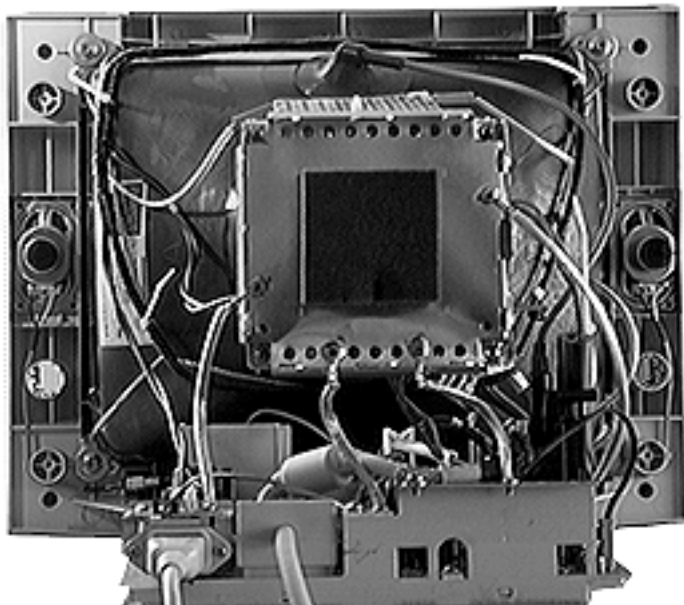



- 1 Turn on the display and let it warm up for five minutes.
- 2 Using the control strip, set the screen resolution to 640x480.
- 3 Using the Display Service Utility, select the crosshatch display pattern with the black background from the Standard Patterns screen.



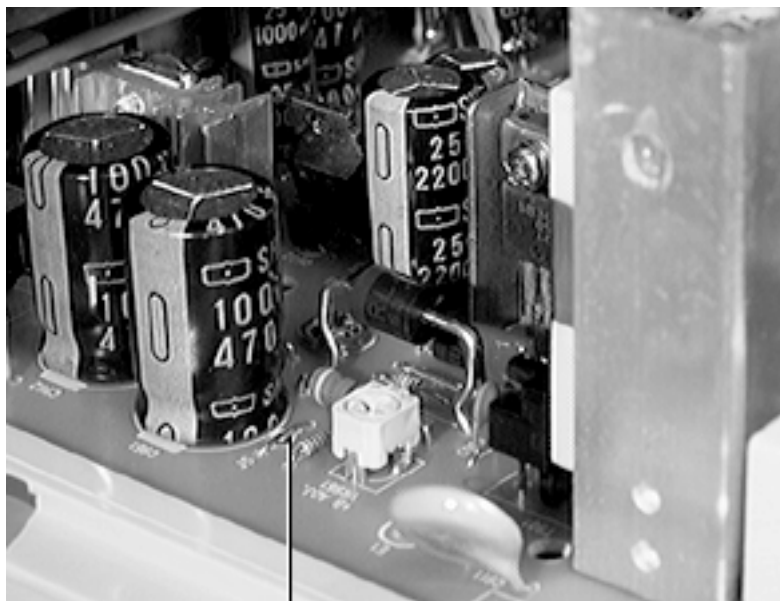

J5

- 4 Locate jumper wire J5 on the left side of the main deflection board.





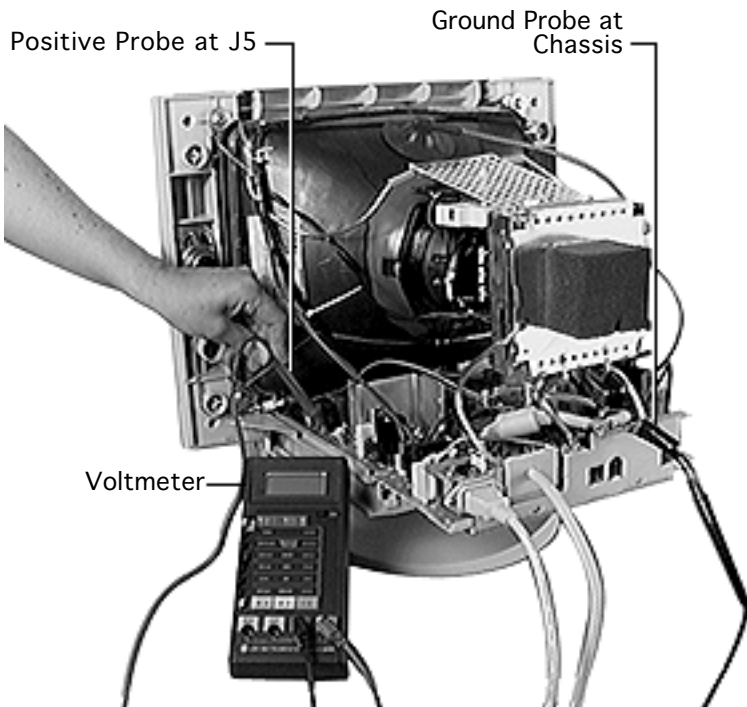

- 5 Connect the positive probe (red wire) of a digital voltmeter to jumper J5 and connect the ground probe (black wire) to the metal chassis.





- 6 While maintaining the voltmeter probe connections, use a plastic screwdriver to adjust VR951 until the voltmeter reads 50 VDC  $\pm$  0.2V.

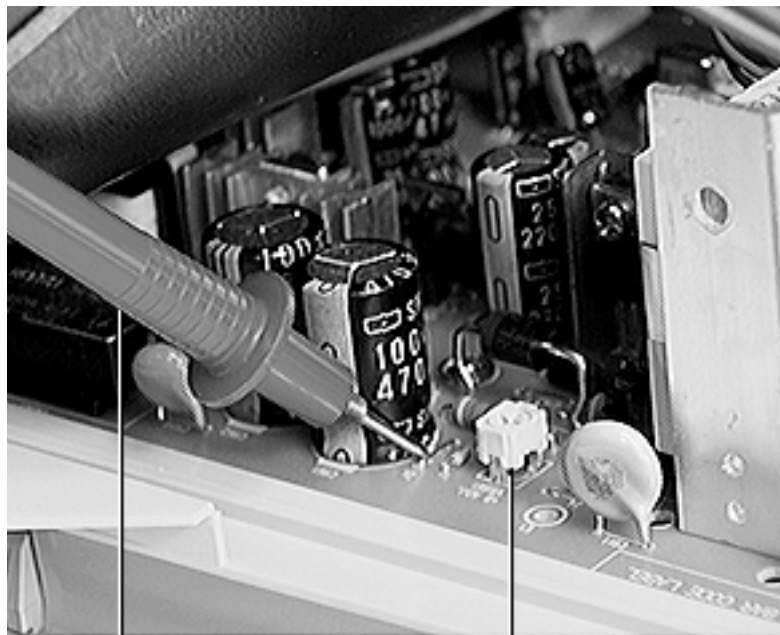

Positive Probe at J5

VR951





## High Voltage

Before you begin, refer to the Take Apart chapter to remove the rear housing.

**⚠ Warning:** This product contains high voltage and a high-vacuum picture tube. To prevent serious injury, review CRT safety in Bulletins/Safety.

**Note:** Perform the high-voltage adjustment whenever the main deflection board is replaced.

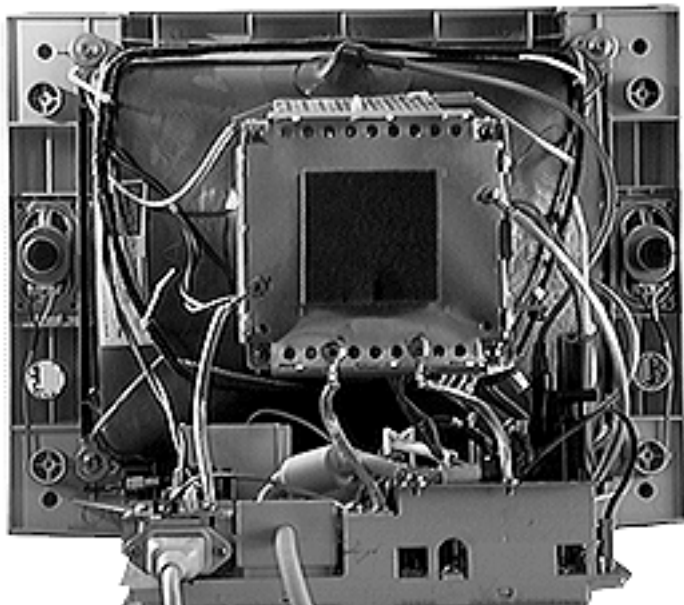



- 1 Turn on the display and let it warm up for five minutes.
- 2 Using the control strip, set the screen resolution to 640x480.
- 3 Using the Display Service Utility, select the crosshatch display pattern with the black background.



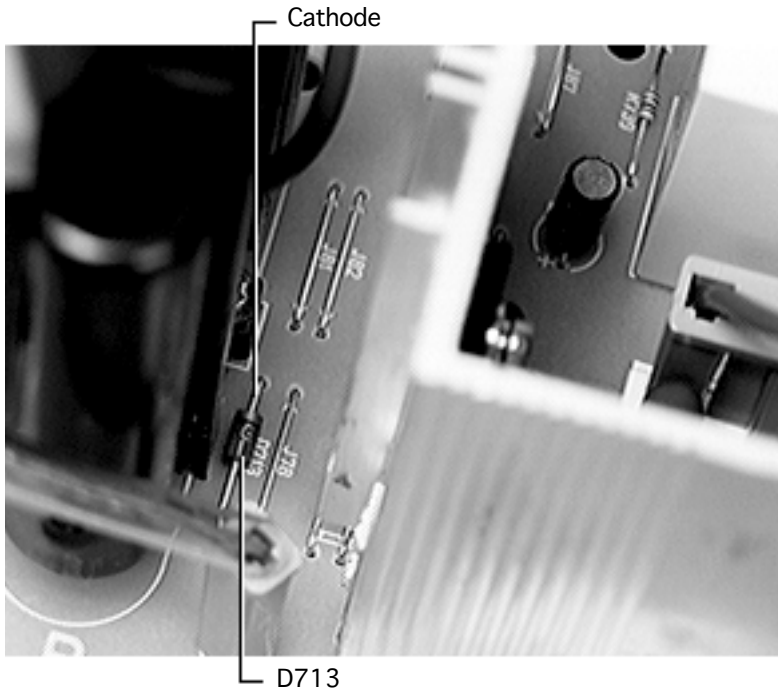

- 4 Locate diode D713 between the flyback transformer and large heatsink on the main deflection board.

Notice the cathode (striped end) of D713.



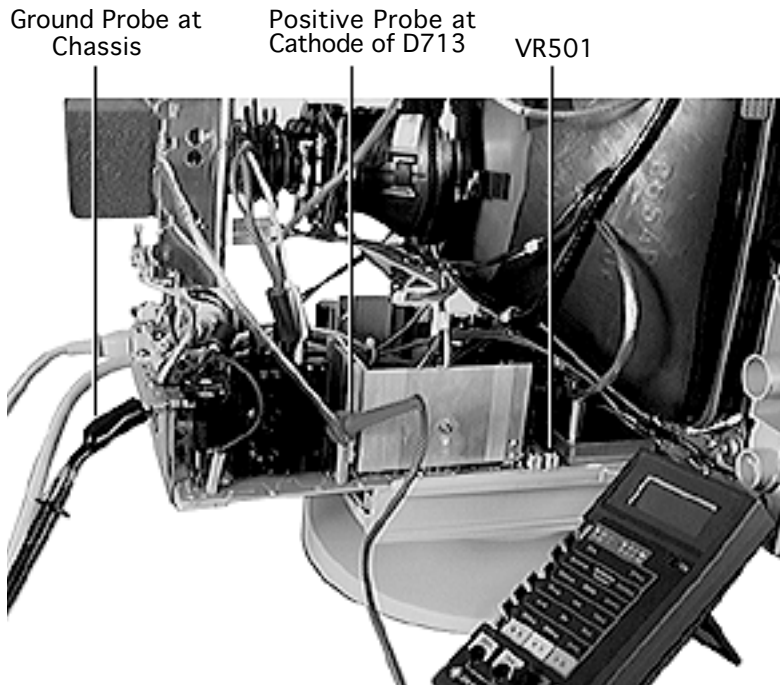

- 5 Connect the positive probe (red wire) of a digital voltmeter to the cathode (striped end) of D713.
- 6 Connect the ground probe of the digital voltmeter (black wire) to the monitor's metal chassis.
- 7 Use a plastic screwdriver to adjust VR501 so that the voltmeter reads a voltage of  $42.5 \text{ VDC} \pm 0.2\text{V}$ .





## Geometry

Before you begin, open the control panel door.

**Note:** In most cases, the preset factory settings require no adjustments to the picture. However, you can fine-tune the screen display by using the front panel controls.



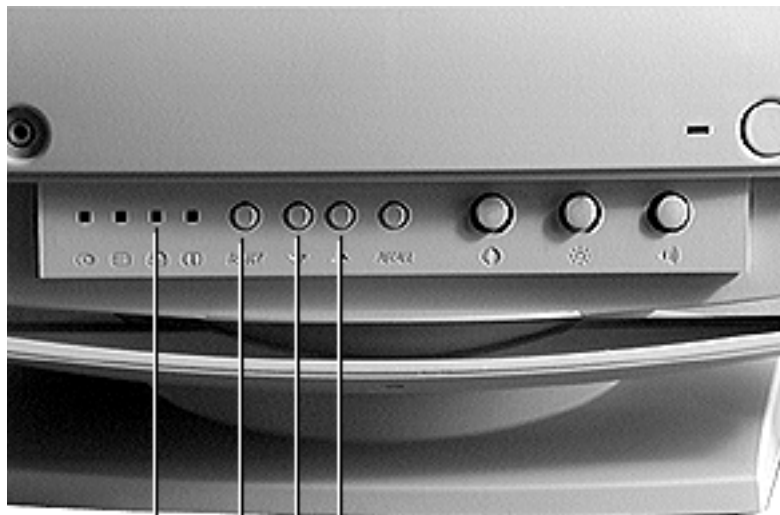

Vertical Center

Select Button

Up Button

Down Button

## Vertical Center

- 1 Press the Select button until the vertical center indicator light turns on.
- 2 Press the up button or down button to move the center of the picture up or down.





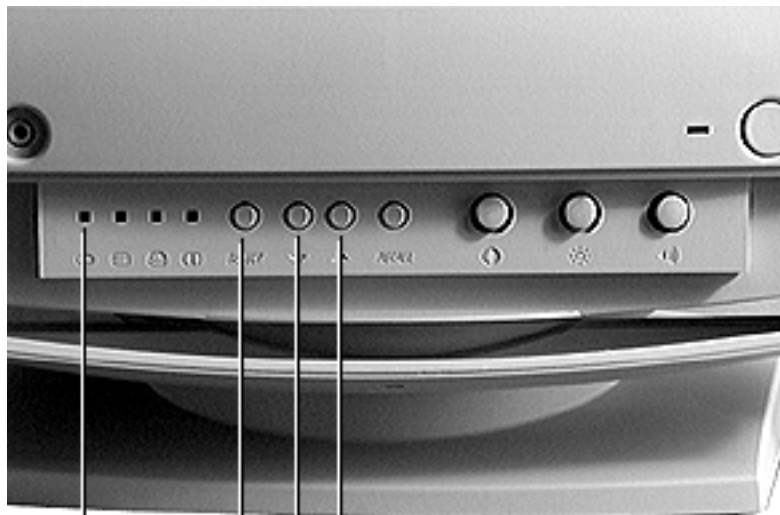

Horizontal Center

Select Button

Up Button

Down Button

## Horizontal Center

- 1 Press the Select button until the horizontal center indicator light turns on.
- 2 Press the up button or down button to move the center of the picture right or left.





Vertical Size

Select Button

Up Button

Down Button

## Vertical Size

- 1 Press the Select button until the vertical size indicator light turns on.
- 2 Press the up button or down button to increase or decrease the height of the picture.

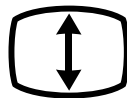



Horizontal Size

Select Button

Up Button

Down Button

## Horizontal Size

- 1 Press the Select button until the horizontal size indicator light turns on.
- 2 Press the up button or down button to increase or decrease the width of the picture.

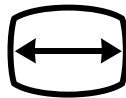

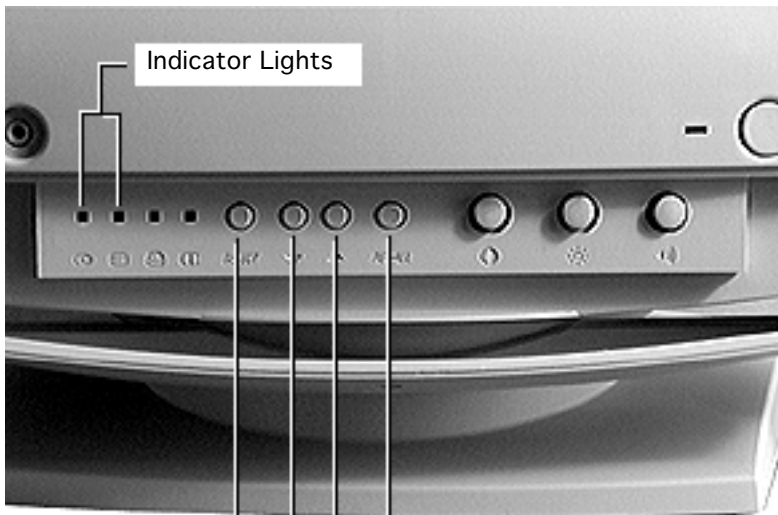

Indicator Lights

Select Button

Down Button

Up Button

Recall Button

## Pincushion

- 1 Simultaneously press the Select and Recall buttons so that the two leftmost indicator lights turn on.
- 2 Press the up button or down button to change the curvature of the right and left sides of the picture.



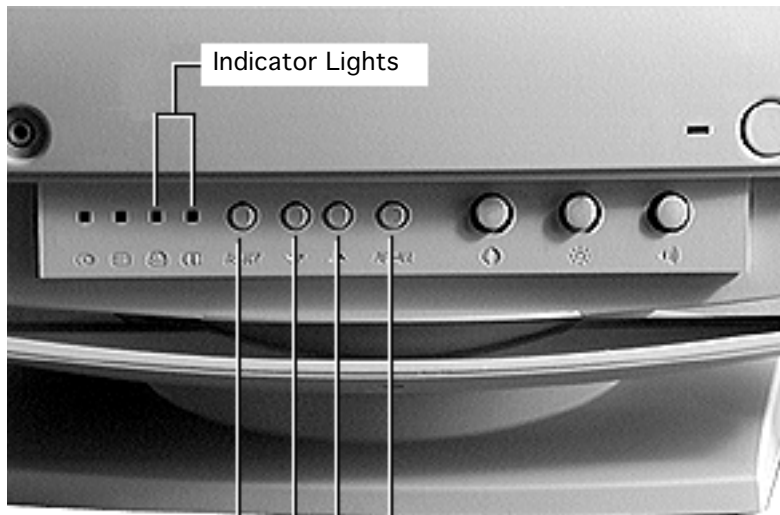

## Keystone

- 1 Simultaneously press the Select and Recall buttons so that the two leftmost indicator lights turn on.
- 2 Press the Select button so that the two rightmost indicator lights turn on.
- 3 Press the up button or down button to change the slant of the right and left sides of the picture.



Select Button

Down Button

Up Button

Recall Button



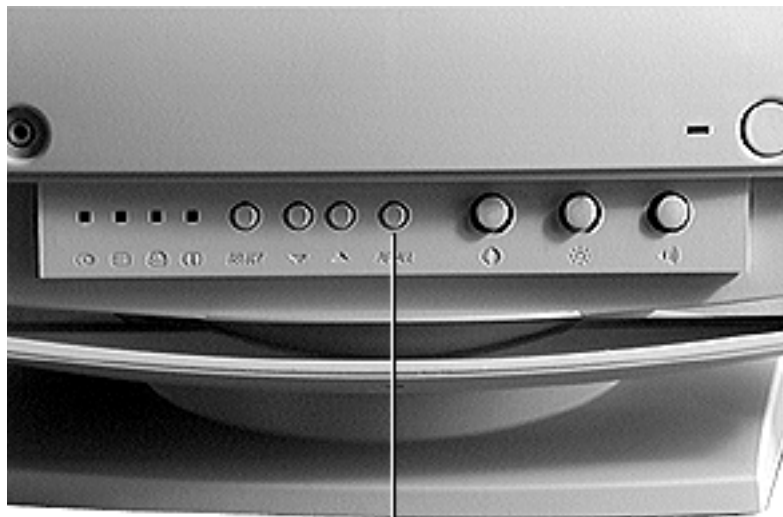

Recall Button

## Recalling Factory Settings

**Important:** The monitor controls are set at the factory. To fine-tune and adjust the picture, use the front panel controls. The monitor will use your settings each time the computer is turned on.

To revert to factory settings, press the Recall button.





## Focus Adjustment

Before you begin, refer to the Take Apart chapter to remove the rear housing.

**⚠ Warning:** This product contains high voltage and a high-vacuum picture tube. To prevent serious injury, review CRT safety in Bulletins/Safety.

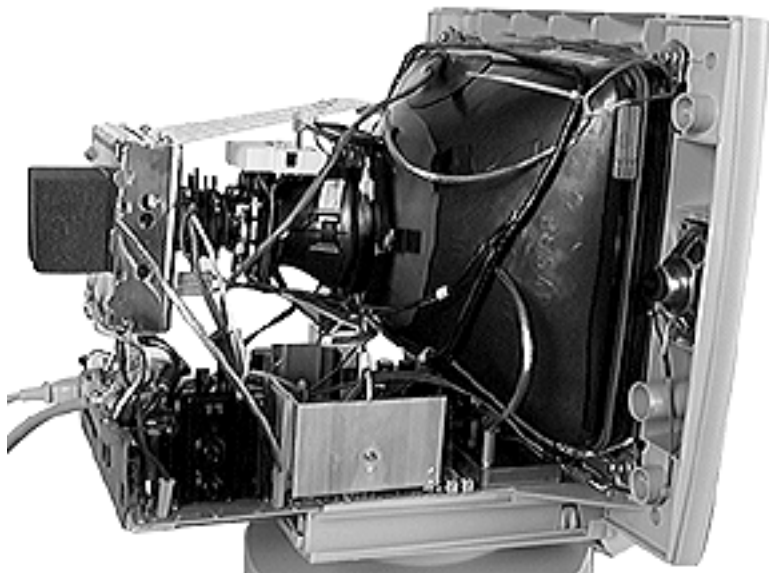



**⚠ Warning:** Because you make adjustments from the rear of the monitor, position a mirror to view the monitor screen. Do not reach around the monitor to adjust the controls.

- 1 Turn on the display and let it warm up for five minutes.
- 2 Using the control strip, set the display to its highest resolution.
- 3 Using the Display Service Utility, select the focus pattern.







Contrast

Brightness

- 4 Set the brightness and contrast controls to maximum (turn fully clockwise).



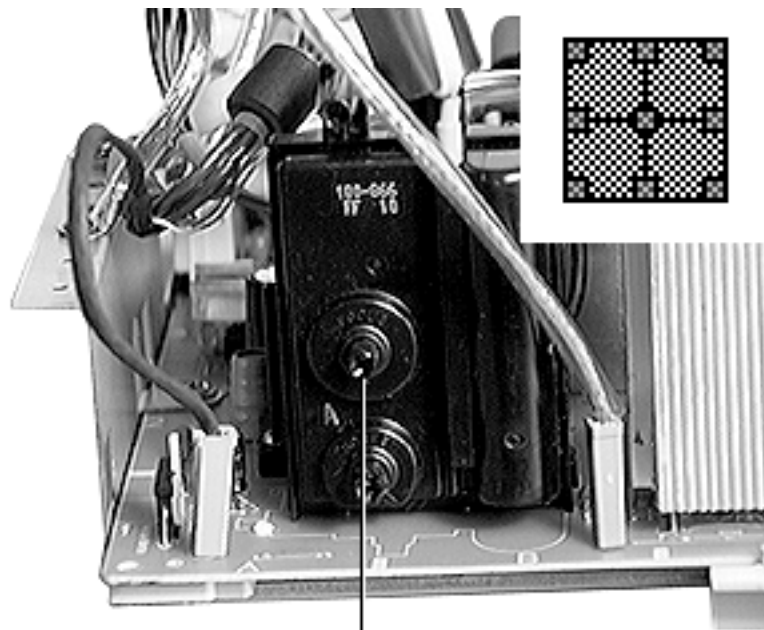

Focus

- 5 Use a plastic screwdriver to adjust the Focus control on the flyback transformer for best center screen focus.





Brightness

- 6 Reset the brightness control to its detent (middle) position.





## Horizontal Centering

Before you begin, refer to the Take Apart chapter to remove the rear housing.

**⚠ Warning:** This product contains high voltage and a high-vacuum picture tube. To prevent serious injury, review CRT safety in Bulletins/Safety.

**⚠ Warning:** Because you make adjustments from the rear of the monitor, position a mirror to view the

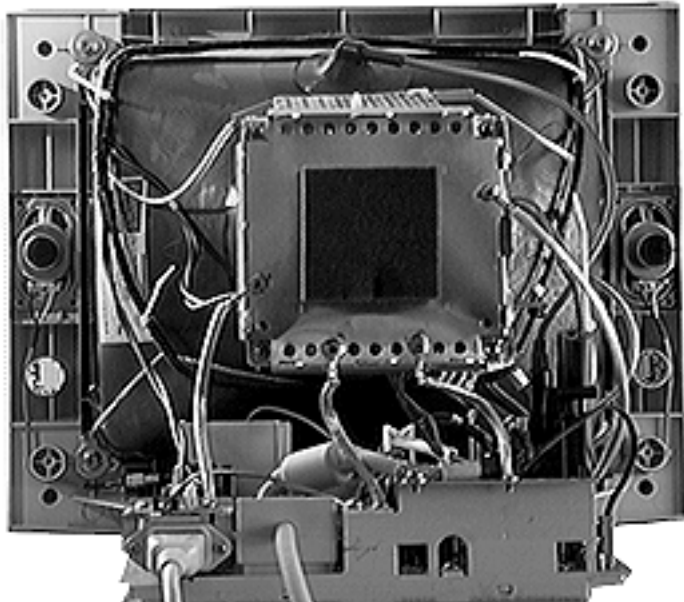



monitor screen. Do not reach around the monitor to adjust the controls.

**Note:** Perform the horizontal centering adjustment whenever the horizontal center control on the front panel does not have sufficient range.

- 1 Using the control strip, set the monitor to its highest resolution.





Contrast

Brightness

- 2 Set both brightness and contrast controls to maximum (turn fully clockwise).



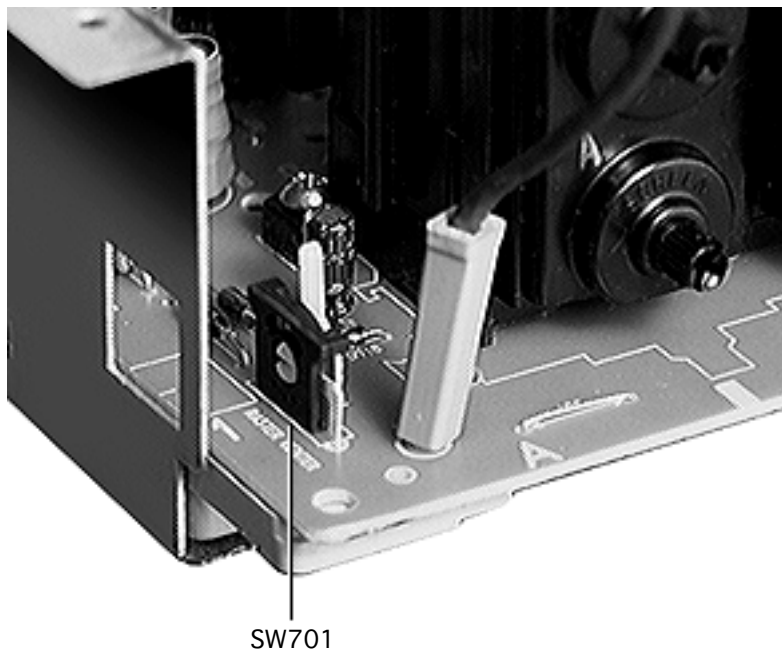

- 3 Use a plastic screwdriver to position the arm of the horizontal center switch (SW701) until the raster is centered.





Brightness

- 4 Reset the brightness control to its detent (middle) position.







## Cutoff and White Balance

Before you begin, refer to the Take Apart chapter to remove the rear housing.

**⚠ Warning:** This product contains high voltage and a high-vacuum picture tube. To prevent serious injury, review CRT safety in Bulletins/Safety.

**⚠ Warning:** Because you make adjustments from the rear of the monitor, position a mirror to view the

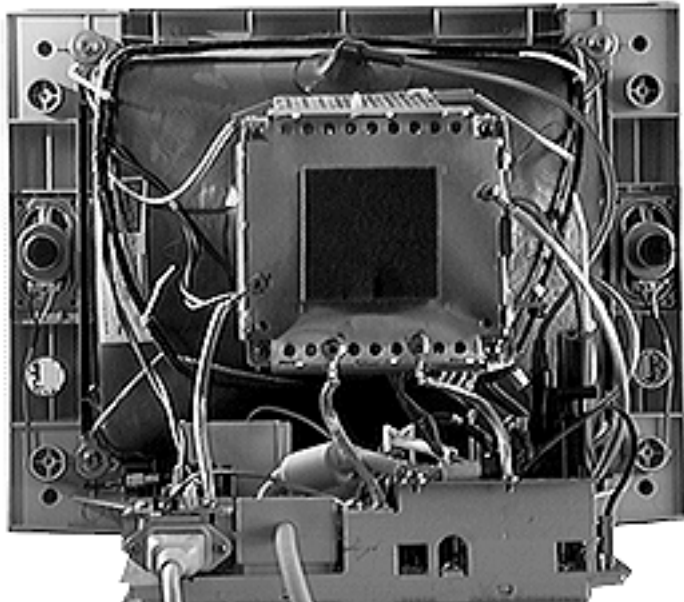



monitor screen. Do not reach around the monitor to adjust the controls.

**Caution:** When adjusting the controls on the CRT/video board, be careful not to apply excessive pressure to the neck of the CRT.

**Note:** Perform cutoff and white balance adjustments whenever the CRT/video board has been replaced or the screen exhibits a predominant color tint.





- 1 Turn on the display and let it warm up for at least 10 minutes.
- 2 Using the control strip, set the display to its highest screen resolution.
- 3 Using the Display Service Utility, select the all-black display pattern.



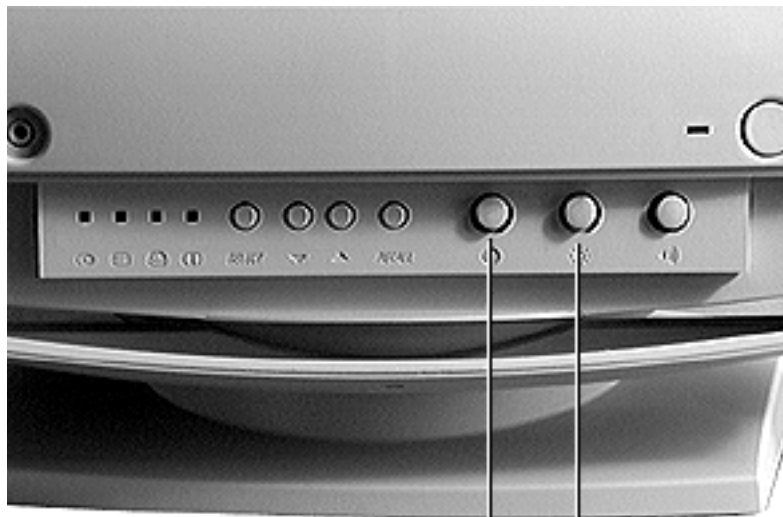

Contrast

Brightness

- 4 Preset both brightness and contrast controls to maximum (turn fully clockwise).





- 5 Use a plastic screwdriver to preset the Sub-Brightness control (VR306) to its maximum setting (counterclockwise).

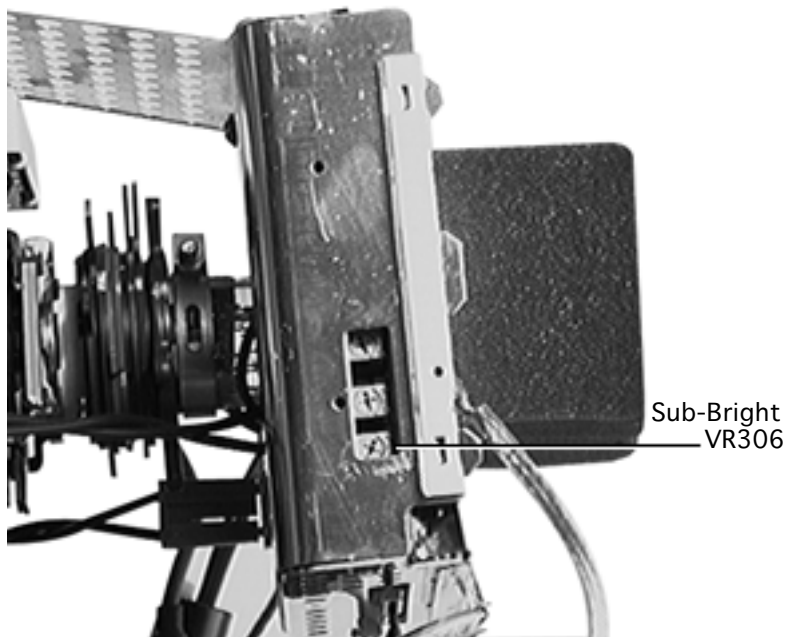

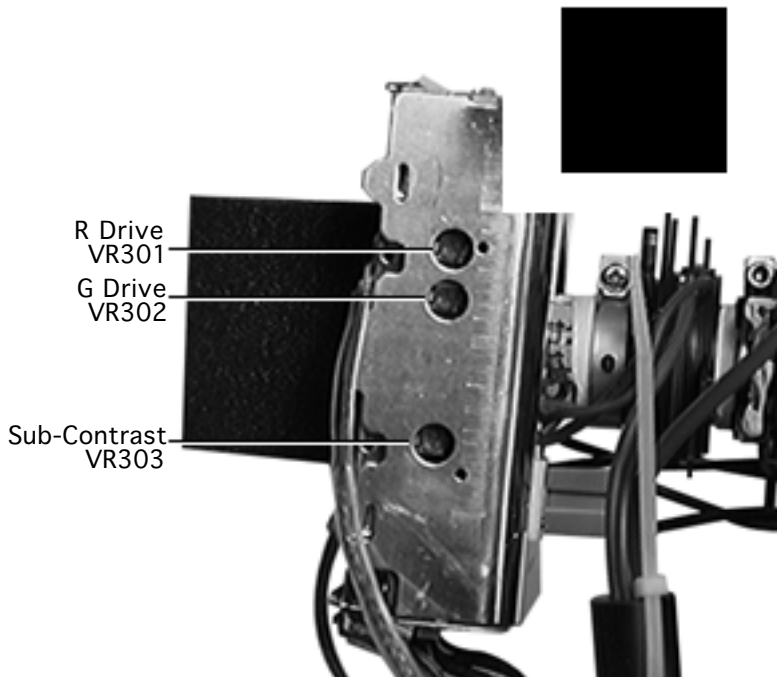

- 6 Preset the following controls to their center positions.
  - Sub-Contrast control (VR303)
  - R Drive control (VR301)
  - G Drive control (VR302)
- 7 If you have set the controls correctly and the monitor is operating normally, the raster should have a bluish cast. If not, recheck the controls you preset in steps 4, 5, and 6.



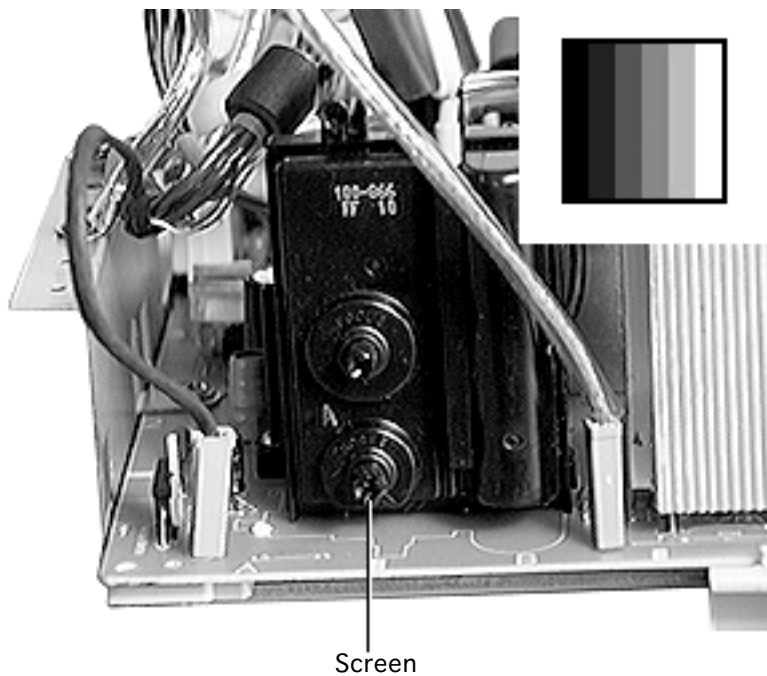

- 8 Using the Display Service Utility, select the gray bars display pattern.
- 9 With the room lights dimmed, use a plastic screwdriver to slowly adjust the Screen control so that the leftmost bar is completely black.



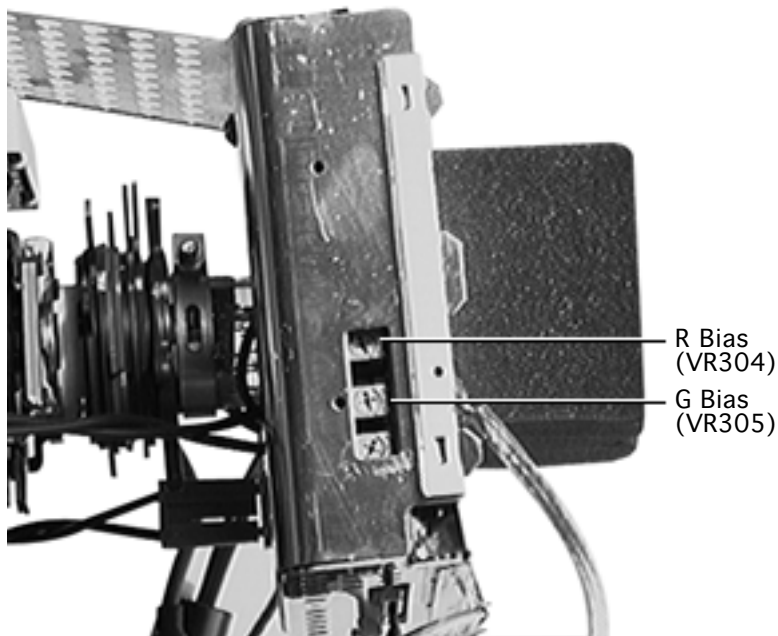

10 Use a plastic screwdriver to adjust the G Bias (VR305) cutoff control until the screen has a bluish-green hue in the darkest bars.

11 Adjust the R Bias (VR304) cutoff control to produce neutral gray in the darkest bars.

**Note:** If you still see a predominant color in the darkest bars, continue adjusting the two bias controls as follows until the bars







Brightness

become neutral gray:

- If the display looks too red, turn up the G Bias or turn down the R Bias
- If the display looks too green, turn up the R Bias or turn down the G Bias

12 Set the brightness control to its detent (middle) position.





- 13 The drive controls normally will not require an adjustment. However, if a predominant color remains in the eight brightest bars, adjust the R Drive and/or G Drive controls to make these bars appear whiter.

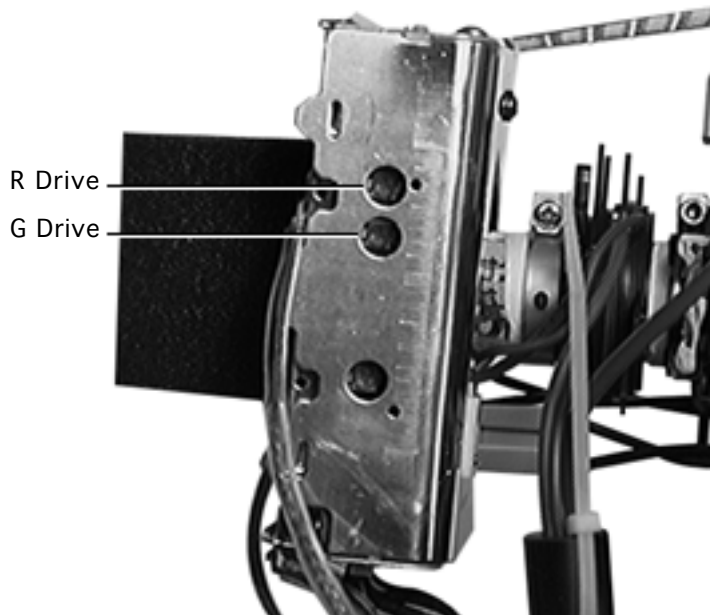



- 14 If required, perform a slight readjustment of the G Bias and R Bias cutoff controls to maintain neutral gray in the eight darkest bars.

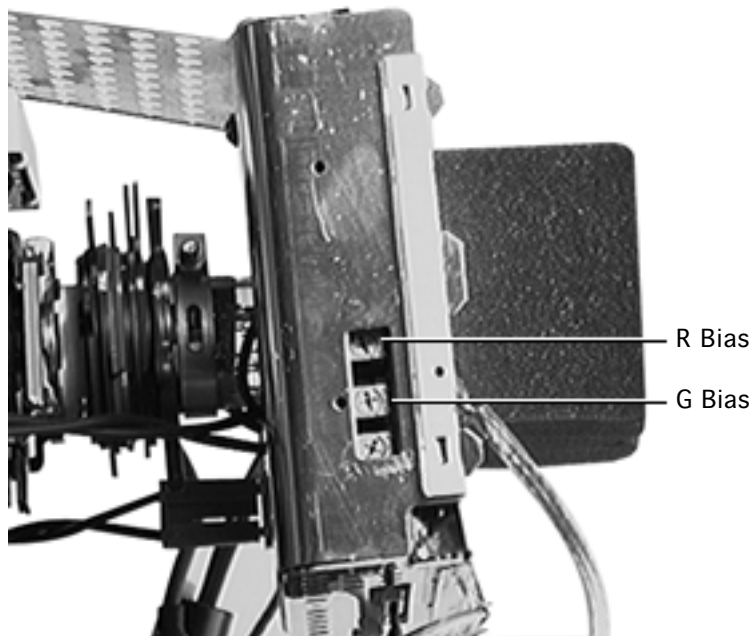

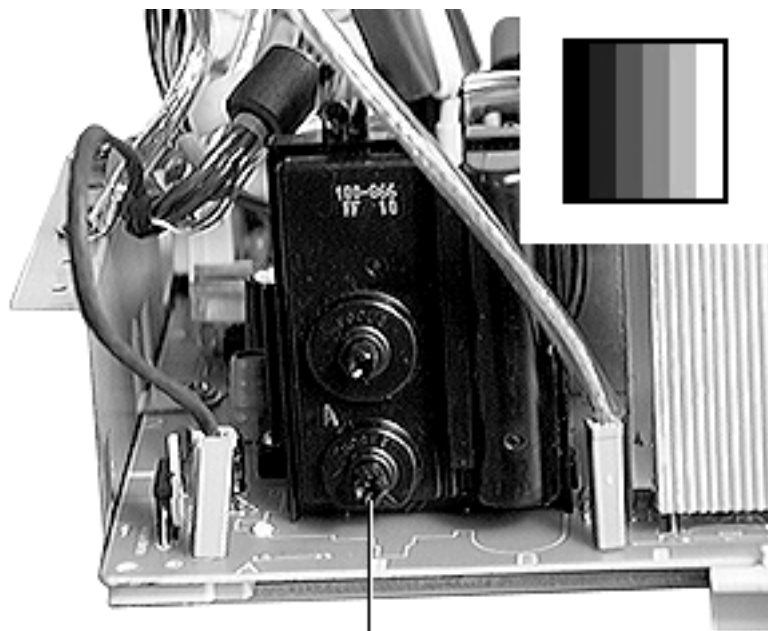

15 If the previous two steps caused more than the leftmost bar to become completely black, perform a slight readjustment of the Screen control so that only the leftmost bar is completely black.

Screen



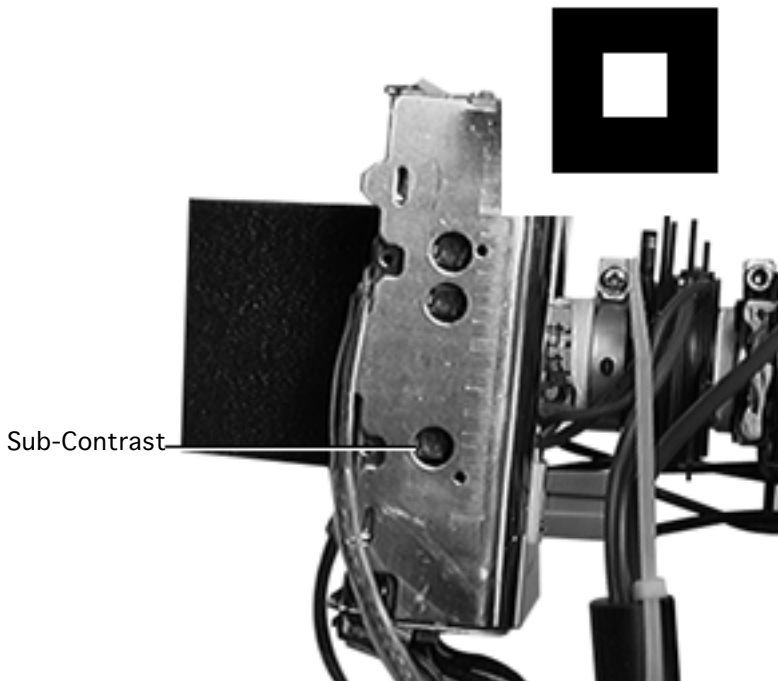

Sub-Contrast

- 16 Using the Display Service Utility, select the Apple MultiScan 1705 selection screen, and then select the display pattern with the small white square in the center of a black screen.
- 17 Adjust the Sub-Contrast control so that the luminance in the center of the screen measures
  - 21 on the red scale of the 246 light meter
  - 25 foot lamberts on a photometer



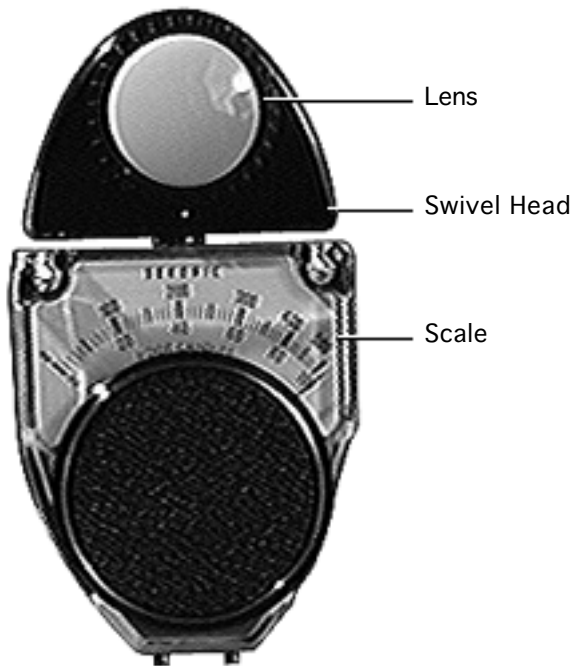

## Light Meter Setup (Model 246)

Before you begin,

- Remove the metal slide (if installed) from the top of the light meter
- Install the white lens with the red dot

- 1 Rotate the swivel head of the meter so the lens and the scale face opposite directions.





- 2 Place the lens against the middle of the screen and read the scale.





Exploded View

Apple Multiple Scan 15AV  
Display





