

## **PROPRIETARY NOTICE AND LIABILITY DISCLAIMER**

The information disclosed in this document, including all designs and related materials, is the valuable property of NEC Computer Systems Division, Packard Bell NEC, Inc. (NECCSD, PBNEC) and/or its licensors. NECCSD and/or its licensors, as appropriate, reserve all patent, copyright and other proprietary rights to this document, including all design, manufacturing, reproduction, use, and sales rights thereto, except to the extent said rights are expressly granted to others.

The NECCSD product(s) discussed in this document are warranted in accordance with the terms of the Warranty Statement accompanying each product. However, actual performance of each such product is dependent upon factors such as system configuration, customer data, and operator control. Since implementation by customers of each product may vary, the suitability of specific product configurations and applications must be determined by the customer and is not warranted by NECCSD.

To allow for design and specification improvements, the information in this document is subject to change at any time, without notice. Reproduction of this document or portions thereof without prior written approval of NECCSD is prohibited.

FaxFlash is a service mark of NEC Computer Systems Division (NECCSD), Packard Bell NEC, Inc. NEC is a registered trademark, Versa is a U.S. registered trademark, MiniDock, VersaBay, VersaGlide, and PortBar are trademarks, and UltraCare is a U.S. registered service mark of NEC Corporation, used under license.

All other product, brand, or trade names used in this publication are the property of their respective owners.

First Printing — September 1997

Copyright 1997  
NEC Computer Systems Division, Packard Bell NEC, Inc.  
1414 Massachusetts Avenue  
Boxborough, MA 01719  
All Rights Reserved

# Preface

This service and reference manual contains the technical information necessary to set up and maintain the NEC Versa<sup>®</sup> 6060 notebook computer.

The manual also provides hardware and interface information for users who need an overview of the system design. The manual is written for NEC-trained customer engineers, system analysts, service center personnel, and dealers.

The manual is organized as follows:

**Section 1 — Technical Information**, provides an overview of the hardware and interface components. System specifications are listed including computer dimensions, weight, environment, safety compliance, power consumption, and system memory specifications.

**Section 2 — Setup and Operation**, takes the authorized service technician or dealer from unpacking to setup and operation. The section includes a description of operating controls, setting parameters and accessing the NECCSD bulletin board system (BBS).

**Section 3 — Troubleshooting**, lists troubleshooting procedures as well as helpful servicing hints.

**Section 4 — Field Service Guidelines**, provides disassembly and assembly procedures, and an exploded-view diagram of the NEC Versa system with part numbers.

**Appendix A — Connector Locations and Pin Assignments**, provides a list of the main board internal connector pin assignments and a list of external pin assignments.

**Appendix B — Video Modes**, lists NEC Versa supported video modes.

An **Index** is included for convenience.

---

---

## Abbreviations

A	ampere	DC	direct current
AC	alternating current	DIMM	dual-inline memory module
ACPI	advanced control power interface	DIP	dual in-line package
APM	advanced power management	DLAB	Divisor Latch Address bit
AT	advanced technology (IBM PC)	DMA	direct memory access
BBS	Bulletin Board System	DMAC	DMA controller
BCD	binary-coded decimal	DOS	disk operating system
BCU	BIOS Customized Utility	DRAM	dynamic RAM
BIOS	basic input/output system	DTE	data terminal equipment
bit	binary digit	ECC	error checking and correction
bpi	bits per inch	ECP	extended capabilities port
bps	bits per second	EDO	enhanced data out
BUD	BIOS Upgrade Diskette	EDS	error detecting system
C	Celsius or centigrade	EGA	Enhanced Graphics Adapter
Cache	high-speed buffer storage	EMS	Expanded Memory Specification
CAM	constantly addressable memory	EPP	enhanced parallel port
CAS	column address strobe	EPROM	erasable and programmable ROM
CCFT	cold cathode	EVGA	Enhanced Video Graphics Array
CD-ROM	compact disk ROM	F	Fahrenheit
CGA	Color Graphics Adapter	FAX	facsimile transmission
CGB	Color Graphics Board	FCC	Federal Communications Commission
CH	channel	FDD	floppy disk drive
clk	clock	FG	frame ground
cm	centimeter	FIR	fast infrared
CMOS	complementary metal oxide semiconductor	FM	frequency modulation
codec	compressor/decompressor	Fn	function
COM	communication	FPU	floating-point unit
CONT	contrast	FRU	field-replaceable unit
CPGA	ceramic pin grid array	GB	gigabyte
CPU	central processing unit	GND	ground
CRT	cathode-ray tube	GUI	graphical user interface
DAC	digital-to-analog converter	HDD	hard disk drive
DACK	DMA acknowledge		

---

HEX	hexadecimal	MFM	modified frequency modulation
HGA	Hercules Graphics Adapter	Mhz	megahertz
Hz	hertz	mm	millimeter
IC	integrated circuit	ms	millisecond
ID	identification	MSB	most-significant bit
IDE	intelligent device electronics	NASC	National Authorized Service Center
IDTR	interrupt descriptor table register	NC	not connected
IMR	Interrupt Mask register	NDP	numeric data processor
in.	inch	NMI	Non-maskable Interrupt
INTA	interrupt acknowledge	ns	nanosecond
IPB	illustrated parts breakdown	NSRC	National Service Response Center
IR	infrared	NTFS	NT file allocation
IRR	Interrupt Request register	PAL	programmable array logic
ISA	Industry Standard Architecture	PC	personal computer
ISR	In Service register	PCB	printed circuit board
I/O	input/output	PCI	peripheral component interconnect
IPC	integrated peripheral controller	PFP	plastic flat package
ips	inches per second	PIO	parallel input/output
IRQ	interrupt request	pixel	picture element
K	kilo (1024)	PJQFP	plastic J-lead quad flat pack
k	kilo (1000)	PLCC	plastic lead chip carrier
KB	kilobyte	PLL	phase lock loop
kg	kilogram	p-p	peak-to-peak
kHz	kilohertz	PnP	Plug and Play
kV	kilovolt	PPI	programmable peripheral interface
lb	pound	PROM	programmable ROM
LCD	liquid crystal display	QFP	quad flat pack
LDTR	local descriptor table register	RAM	random-access memory
LED	light-emitting diode	RAMDAC	RAM digital-to-analog
LSB	least-significant bit	RAS	row address strobe
LSI	large-scale integration	RGB	red green blue
M	mega	RGBI	red green blue intensity
mA	milliamps	ROM	read-only memory
max	maximum	rpm	revolutions per minute
MB	megabyte		
MDA	Monochrome Display Adapter		

---

R	read
RTC	real-time clock
R/W	read/write
S	slave
SCSI	Small Computer System Interface
SDLC	Synchronous Data Link Control
SG	signal ground
SIMM	single inline memory module
SIR	serial infrared
SOIC	small outline integrated circuit
SQFP	silver quad flat package
SVGA	Super Video Graphics Array
SW	switch
TCP	thin chip package
TFT	thin film transistor
TQFP	thin-quad flat package
TSC	Technical Support Center
TTL	transistor/transistor logic
tpi	tracks per inch
UART	universal asynchronous receiver/transmitter
USB	Universal Serial Bus
V	volt
Vdc	volts, direct current
VESA	Video Electronics Standards Association
VFO	variable frequency oscillator
VGA	Video Graphics Array
VLSI	very large-scale integration
VRAM	virtual RAM
W	watt
$\mu$ f	microfarad
$\mu$ PD	microprocessor
$\mu$ s	microsecond
$\Omega$	ohm

---

---

# Contents

Preface.....	xi
Abbreviation .....	xiii
<b>Section 1 Technical Information</b>	
Hardware Overview—Front.....	1-2
Liquid Crystal Display (LCD).....	1-2
Power Button .....	1-3
LCD Status Bar and Power Indicator .....	1-4
Status Icons .....	1-5
Keyboard .....	1-5
NEC VersaGlide .....	1-6
Diskette Drive and the NEC VersaBay II .....	1-7
Infrared (IR) Assembly.....	1-7
Hardware Overview—Right Side.....	1-8
Hardware Overview—Left Side.....	1-9
PC Card Slots .....	1-9
Battery Bay Cover Release.....	1-9
Hardware Overview—Rear Side .....	1-10
Keyboard/Mouse Port.....	1-10
Parallel Port (LPT1).....	1-10
Expansion Port .....	1-11
External Monitor (Video) Port .....	1-11
Serial Port (COM1) .....	1-11
Hardware Overview—Internal Components .....	1-11
Battery Pack .....	1-11
Hard Disk Drive.....	1-11
Diskette Drive.....	1-12
Versa Bay II SuperDisk LS-120 Drive .....	1-12
20X CD-ROM Reader .....	1-12
CPU Board .....	1-12
Audio Board .....	1-13
AMP Board .....	1-14
I/O Board .....	1-14
CMOS Battery.....	1-14
Bridge Battery .....	1-14

---

System Memory.....	1-14
Memory Map.....	1-14
System Video.....	1-15
Parallel Interface.....	1-15
Serial Interface.....	1-16
NEC Versa Chip Set.....	1-16
Intel Pentium P55CLM Microprocessor.....	1-17
M-Triton System Controllers.....	1-17
256K X Flash ROM.....	1-17
ROM BIOS.....	1-17
VGA Controller.....	1-18
Parallel Interface.....	1-18
Keyboard Controller.....	1-18
PC CardBus Controller.....	1-19
Sound Integrated Circuit.....	1-19
Interrupt Controllers.....	1-20
Power Management Overview.....	1-21
System Power Management.....	1-22
Local Power Management.....	1-22
Plug and Play.....	1-23
Specifications.....	1-24

## **Section 2 Setup and Operation**

Unpacking the System.....	2-1
Hardware Setup.....	2-1
Cable Connections.....	2-3
Power Sources.....	2-4
Using the AC Adapter.....	2-4
Using the Main Battery Pack.....	2-5
Checking Battery Power Levels.....	2-5
What to Do When Battery Power Gets Low.....	2-5
Returning the Battery to Full Operation.....	2-6
When to Change the Battery.....	2-6
Battery Handling.....	2-6
Replacing the Battery Pack.....	2-7
Battery Precautions.....	2-10
Recharging Battery Precautions.....	2-10

---

---

NEC VersaBay II Battery and Adapter Kit (Optional) .....	2-11
Extending Battery Life .....	2-11
Using the DC Car Adapter .....	2-11
Operating Controls .....	2-12
Status Bar .....	2-13
Status Icons .....	2-13
Function Keys (Fn Keys).....	2-14
Smart Power Switch .....	2-14
Dip Switch.....	2-15
Updating the System BIOS .....	2-15
Customizing BIOS Message.....	2-17
Power-on Self-Test (POST).....	2-17
POST Errors.....	2-18
Setup Utility .....	2-19
Accessing Setup.....	2-20
With an Error at POST .....	2-20
With No Errors at POST.....	2-20
Setup Utility Main Menu.....	2-20
How to Use Setup.....	2-21
Looking at Screens .....	2-21
Using Keys.....	2-22
Checking/Setting System Parameters.....	2-22
Setup Menus.....	2-25
Standard CMOS Setup.....	2-27
Advanced CMOS Setup .....	2-26
Power Management Setup Power Management Setup .....	2-26
Peripherals Setup .....	2-28
Change User Password.....	2-28
Change Supervisor .....	2-28
Auto Configuration with Defaults.....	2-28
Save Setting and Exit .....	2-28
Exit Without Saving.....	2-29
Using Setup to Set Power Management .....	2-29
Using the Save to File (STF) Feature.....	2-29
STF Benefits .....	2-30
Automatic Power-Saving Features .....	2-31

---



**Section 3 Troubleshooting**

Quick Troubleshooting ..... 3-1  
Helpful Questions ..... 3-4

**Section 4 Field Service Guidelines**

Preventive Maintenance ..... 4-1  
    Cleaning the Notebook's Exterior ..... 4-1  
    Cleaning the Notebook's Interior ..... 4-2  
    Protecting the Disk Drives ..... 4-2  
    Handling the Battery Packs ..... 4-3  
    Maintaining the LCD Quality ..... 4-3  
Required Tools and Equipment ..... 4-3  
Disassembly and Reassembly..... 4-4  
    Hard Disk Drive..... 4-5  
    Diskette Drive..... 4-7  
    Main Battery Pack (Li-Ion Type) ..... 4-8  
    LCD and Top Cover ..... 4-10  
    Power Button, Microphone Assembly, Keyboard ..... 4-12  
    LCD Status Bar, VersaGlide Assembly, Metal Keyboard Supports..... 4-14  
    Bridge Battery, CMOS Battery, Buzzer ..... 4-15  
    CPU Board ..... 4-16  
    AMP Board ..... 4-17  
    I/O Board ..... 4-17  
Illustrated Parts Breakdown..... 4-18  
Service Information..... 4-22  
Technical Support..... 4-22  
Product Information..... 4-23  
Ordering Information from FaxFlash ..... 4-24

**Appendix A Connector Locations and Pin Assignments**

**Appendix B Video Modes**

**Index**

---

**List of Figures**

1-1	NEC Versa 6060 Notebook .....	1-1
1-2	LCD Panel .....	1-3
1-3	Power Button Location .....	1-4
1-4	System Status Bar .....	1-4
1-5	Keyboard Layout .....	1-6
1-6	VersaGlide Location .....	1-6
1-7	NEC VersaBay II Location .....	1-7
1-8	Right Side Features .....	1-8
1-9	Left Side Features .....	1-9
1-10	Rear Features .....	1-10
1-11	CPU Board Layout .....	1-12
1-12	Audio Board Layout .....	1-13
2-1	Connecting the AC Adapter .....	2-1
2-2	Powering on the System .....	2-2
2-3	Power and I/O Connector Locations .....	2-3
2-4	NEC Versa AC Adapter .....	2-4
2-5	Removing the Cover .....	2-8
2-6	Removing the Battery .....	2-8
2-7	Inserting the Battery Pack .....	2-9
2-8	Replacing the Cover .....	2-9
2-9	Connecting the Car DC Adapter .....	2-11
2-10	Keyboard Panel LEDs and Controls .....	2-12
2-11	Status Bar Location .....	2-13
2-12	Dip Switch Location .....	2-16
2-13	Setup Main Menu .....	2-21
2-14	Advanced CMOS Setup Menu .....	2-22
4-1	Removing the Drive Bay Cover .....	4-5
4-2	Removing the Hard Disk Drive .....	4-6
4-3	VersaBay II Release Latches .....	4-7
4-4	Removing the Standard Diskette Drive .....	4-8
4-5	Removing the Battery Compartment Cover .....	4-9
4-6	Removing the Battery .....	4-9
4-7	Removing the Bottom Base Screws .....	4-10
4-8	Disconnecting the LCD Connectors .....	4-11

4-9	Removing the Power Button, Microphone Assembly, Keyboard.....	4-12
4-10	Disconnecting Keyboard Cables .....	4-13
4-11	LCD Status Bar, VersaGlide Assembly, Metal Keyboard Supports.....	4-14
4-12	Bridge Battery, CMOS Battery, Buzzer .....	4-15
4-13	Removing the CPU Board.....	4-16
4-14	Removing the I/O Board .....	4-18
4-15	NEC Versa Model 6060 Illustrated Parts Breakdown.....	4-26
A-1	CPU Board Layout .....	A-1
A-2	I/O Board Layout.....	A-2

### List of Tables

1-1	Model Configurations .....	1-2
1-2	Memory Map .....	1-15
1-3	NEC Versa Series Chip Types and Technologies.....	1-16
1-4	Interrupt Controllers .....	1-20
1-5	Automatic Power-Saving Features .....	1-21
1-6	Maximum Performance Default Settings.....	1-23
1-7	Specifications.....	1-24
2-1	I/O Connector Descriptions.....	2-3
2-2	Control and Switch Functions .....	2-12
2-3	Fn Key Operations .....	2-14
2-4	POST Error Messages.....	2-18
2-5	Setup Key Functions .....	2-22
2-6	Setup Parameters .....	2-22
3-1	Quick Troubleshooting.....	3-1
4-1	NEC Versa 6060 Series Disassembly Sequence .....	4-4
4-2	NEC Versa 6060 Series Field-Replaceable Parts.....	4-20
4-3	NEC Service and Information Telephone Numbers.....	4-22
A-1	CPU Board Connectors.....	A-2
A-2	I/O Board Connectors.....	A-2
A-3	Keyboard/Mouse Connectors .....	A-3
A-4	Serial Port Connector Pin Assignments .....	A-3

---

A-5	CRT Connector Pin Assignments .....	A-4
A-6	Parallel Printer Pin Assignments .....	A-4
A-7	Power Connector .....	A-5
A-8	Hard Disk Drive Connector.....	A-5
B-1	LCD Display Mode Setting (800x600 TFT Color LCD and Simultaneous CRT Display) .....	B-1
B-2	LCD Display Extended Video Mode .....	B-2
B-3	CRT Display Mode (CRT only).....	B-3
B-4	CRT Display Extended Video Mode .....	B-4
B-5	Panning Video Mode (800x 600 TFT Color LCD and Simultaneous CRT Display) .....	B-4

---

## Section 1

---

# Technical Information

The NEC Versa 6060 notebook computer is lightweight, compact, and fully IBM compatible. This is the latest addition to the NEC Versa family.

---

 This service manual covers only the NEC Versa 6060 model. All figures in this manual reflect this model.

---



**Figure 1-1 NEC Versa 6060 Notebook**

This section of the manual provides system configuration information, including an overview of hardware and interface components. See the following table for a systems specific breakdown of hardware.

**Table 1-1 Model Configurations**

<b>FEATURE</b>	<b>NEC Versa 6060</b>
CPU	Intel Pentium® with MMX Technology P55CLM/166 MHz
On-Board DRAM	16-MB
Video Memory	2-MB included in video chip
Hard Disk Drive	2.1 GB or 3.2 GB
CD-ROM Reader	20X CD ROM Reader
FDD or SuperDisk LS-120	3 ½" 1.44MB 120MB
Color LCD	12.1" CCFT Super VGA(SVGA),TFT Color Display

## **HARDWARE OVERVIEW—FRONT**

Take a moment to become familiar with the location and function of controls located on the front of the system.

### **Liquid Crystal Display (LCD)**

The LCD operates with NeoMagic NMG4 VGA controller. The controller supports XGA, uses a 64-bit accelerator with a Peripheral Component Interconnect (PCI) interface.

The NEC Versa 6060 LCD features the following:

- 12.1-inch Thin Film Transistor (TFT) CCFT Super VGA (SVGA) single-backlite color
- 0.306 mm dot pitch
- 16-bit digital interface
- 800 x 600 resolution
- 64K colors.

Additional LCD panel features:

- Power LED that indicates the current power status. This LED is visible with the LCD panel opened or closed.
  - Slide switch that adjusts screen brightness.
-

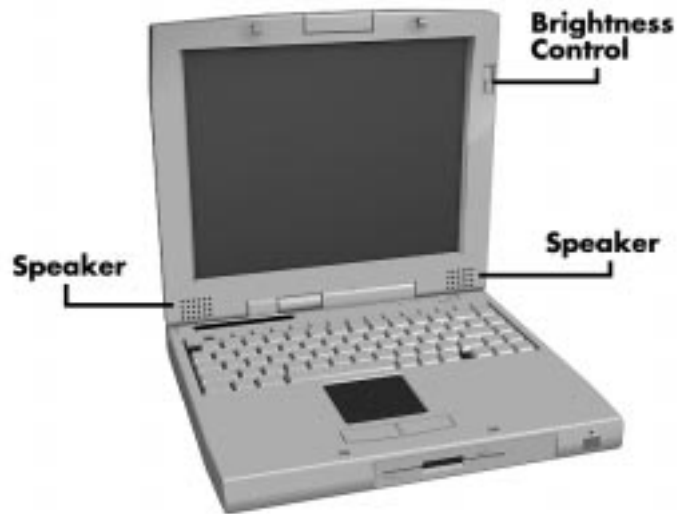

**Figure 1-2 LCD Panel**

Another video feature includes a CRT port on the system's rear panel that allows the user to connect an optional monochrome or color external display to the system. The computer can support the LCD and external display simultaneously.

Power-saving features for controlling the LCD's backlighting include the ROM-based hot key combination **Fn F5**, and Auto Setup power management settings. See Section 2, Setup and Operation, for information on using these settings. In addition, the automatic LCD status feature conserves the backlight. When the LCD is closed the backlight shuts off automatically, saving battery power.

### **Power Button**

Slide the Power button to the right to power on and power off the computer. The Power button is a “smart” switch, meaning that it recognizes when the system is in Suspend mode. If in Suspend mode, you cannot power off until you press the Suspend button again to bring the system out of Suspend mode.

---

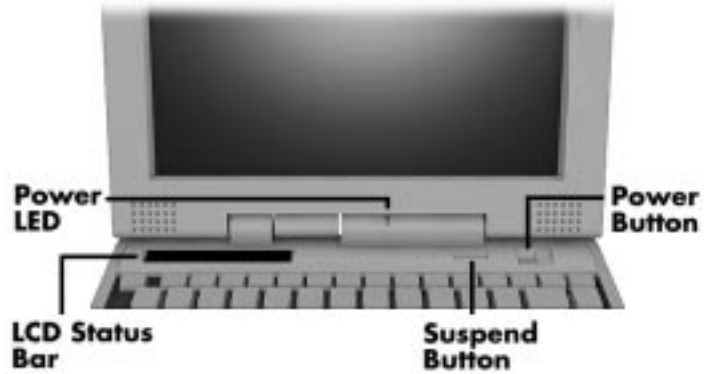
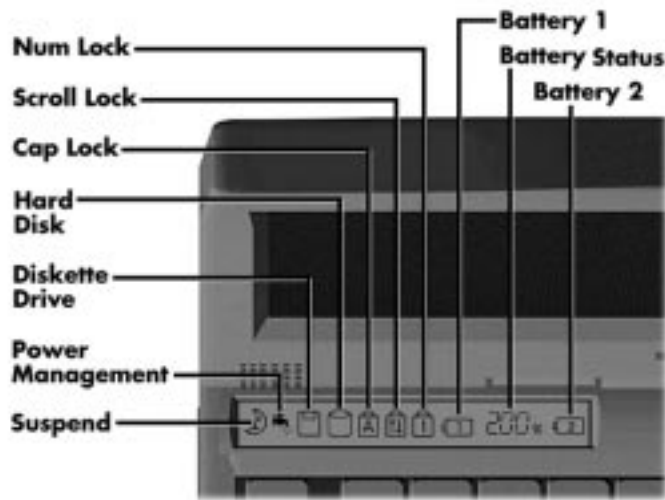

**Figure 1-3 Power Button Location**

### **LCD Status Bar and Power Indicator**

The LCD status bar is situated right below the LCD screen. It provides an easy way to detect system status. Different graphic icons appear on the LCD bar indicating that a device is accessed, an operation performed, or a power mode activated. The graphic icons displayed on the LCD bar resemble either their physical characteristics or their primary function. See the LCD Status Bar figure shown next, and the descriptions that follow for the specific meaning of each icon.

The power indicator is located just above and to the right of the status bar. The power indicator lights green when computer power is on, blinks green when in Suspend mode and blinks amber to indicate that the battery power is low.



**Figure 1-4 System Status Bar**

---



### **Status Icons**

The following list defines the status icons displayed in the system status bar.

- Suspend — appears when the system is in Suspend mode. Suspend mode conserves system power by shutting down devices in the system while retaining data and system status.
- Power Management — shows the current power management mode in use, including Off, Custom, High Performance or Longest Life.
- Diskette or Versa Bay II SuperDisk™ LS-120 drive — appears when the NEC Versa writes data to or retrieves data from a diskette.
- Hard Disk — shows when the NEC Versa writes data to or retrieves data from the hard disk.
- Caps Lock — appears when Caps Lock is in effect.
- Scroll Lock — shows that Scroll Lock is in effect.
- Num Lock — appears when Num Lock is in effect. Num Lock lets the user enter numbers for calculations via the numeric keypad.
- Battery Status — displays the total percentage of battery power available.
  - Battery 1 appears when you have the main battery installed in the battery bay.
  - Battery 2 appears when you have an optional battery installed in the VersaBay II.

### **Keyboard**

The built-in, 83-key keyboard (U.S.) or 79-key keyboard (UK and Germany) uses the standard QWERTY format. The keyboard provides 12 function keys and 7 cursor control keys, with an Fn key for ROM-based key functions. The numeric keypad is embedded in the standard key layout.

---



*Figure 1-5 Keyboard Layout*

## **NEC VersaGlide**

The NEC VersaGlide is a built-in mechanism that functions as the system's mouse. It controls the on-screen pointer (cursor). To use the VersaGlide, move your finger across the NEC VersaGlide pad, and the cursor follows. The buttons below the NEC VersaGlide allow the user to select or deselect menu items. Tap and double-tap are supported on the VersaGlide pad.

If an external mouse is installed, the NEC VersaGlide is deactivated. A serial mouse is not supported.



*Figure 1-6 VersaGlide Location*

---

## Diskette Drive, CD-ROM Reader and the NEC VersaBay II

A standard 1.44-MB diskette drive or Versa Bay II SuperDisk™ LS-120 drive comes installed in the VersaBay II slot on the front of the computer. The VersaBay II expansion slot lets the user replace the standard diskette drive with the 20X CD-ROM reader that also ships with the system. In addition to the CD-ROM reader, the VersaBay II accepts NEC options including a second battery pack, or an additional hard disk.



*Figure 1-7 NEC VersaBay II Location*

## Infrared (IR) Assembly

The IR assembly consists of a small board with one infrared LED and one pin photo diode, attached to the CPU board. The board allows the NEC Versa computer to communicate with other infrared-ready computers. For example, the infrared port allows the user to transfer files between the NEC Versa and an IR-equipped computer, or print to an IR-equipped printer without using cables.

---

**NOTE** Do not use the IR port directly under fluorescent or incandescent light.

---

## HARDWARE OVERVIEW—RIGHT SIDE

Review the following section for a description of the hardware on the right side of the NEC Versa.

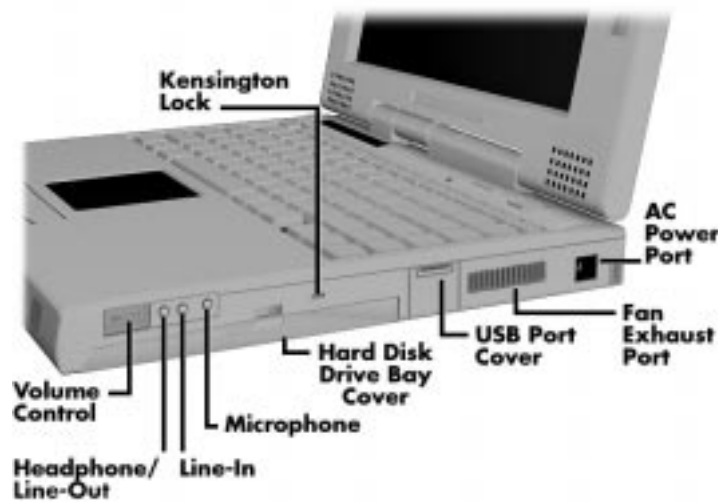

**Figure 1-8 Right Side Features**

- Volume Control — Allows you to control the speaker volume.
  - Headphones/Line-Out — Lets you connect external headphones, speakers or audio system to your NEC Versa system. Using this port disables the built-in system speakers.
  - Line-In — Lets you use another audio system, like a home stereo, as an input source. Use a the cable to connect to the Line-Out port on the other audio system to record or play.
  - Microphone (MIC) — Allows you to connect an external microphone for monophonic recording or amplification through the unit. Plugging in an external microphone disables the built-in microphone.
  - Hard Disk Drive Bay Cover — The hard disk drive bay contains the removable hard disk drive. Depending on your NEC Versa's configuration, it contains a 2.1-GB hard disk drive or 3.2-GB hard disk drive.
  - Kensington Lock Connection — Lets you provide added security by installing an optional Kensington Lock.
  - USB Port — The Universal Serial Bus (USB) allows the connection of up to 127 peripheral devices (printers, monitors, scanners, etc.) to your NEC Versa.
  - Fan Exhaust Port — This port provides air flow from the interior of the computer to assist in keeping the system running at optimal performance.
-

---

 **CAUTION**

Always keep the fan vents clear to allow proper system cooling.

---

- AC Power Port — Use the power jack to attach the NEC Versa to a DC power source, such as the AC adapter or the optional DC car adapter.

## HARDWARE OVERVIEW—LEFT SIDE

Review the following section for a description of the hardware on the left side of the NEC Versa.



*Figure 1-9 Left Side Features*

### PC Card Slots

The PC card slot compartment houses two Type II devices, or one Type III device. For Type III cards, insert the PC card into the lower slot. Insert the card with the pin sockets facing towards the drive and the label facing up. To remove the PC card, push on the eject button to release the pin connections and slowly pull out the card.

### Battery Bay Cover Release

The battery compartment houses the rechargeable Lithium Ion (Li-Ion) battery pack. The battery pack instantly start to charge whenever you connect the AC adapter to the notebook. It is very important to always have the battery installed in the notebook to insure that it is continuously charged. If the battery pack is uninstalled for a long period of time, the battery cells are drained, causing the battery pack to deteriorate.

---

The battery bay contains an eight-cell Lithium Ion (Li-Ion) battery that lets you run your system on DC power.

## HARDWARE OVERVIEW—REAR SIDE

Review the following section for a description of the hardware on the rear of the NEC Versa.

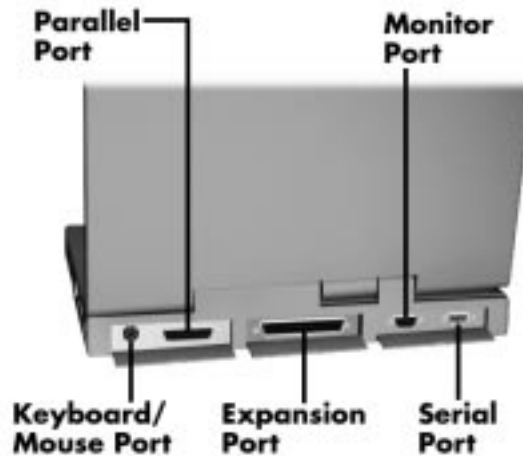

*Figure 1-10 Rear Features*

### Keyboard/Mouse Port

Use the standard PS/2 port to connect an external PS/2-style mouse or a PS/2-style keyboard to the system. With an optional Y-cable adapter, you can connect both a mouse and a keyboard at the same time. A serial mouse is not supported.

### Parallel Port (LPT1)

The 25-pin printer port provides a parallel interface to which you can connect a parallel printer, pocket network adapter or storage devices. Use this port to connect a parallel printer or other parallel device. The port is IEEE 1284 compatible. It supports bi-directional (AT) mode, Enhanced Capabilities Port (ECP) mode, Enhanced Parallel Port (EPP) mode, (365SL-compatible), nibble mode, and byte mode (PS/2).

The parallel port default is Extended Capabilities Port (ECP) mode. Use Setup to change the default to one of the following.

- Uni-directional
  - Bi-directional
  - EPP
  - ECP
-

## Expansion Port

This port provides a connection for NEC Versa options including the NEC PortBar 6000, NEC Versa Docking Station 6000 Plus, NEC Versa MiniDock 6000 and the NEC Floppy Disk Drive (FFD) Connector.

## External Monitor (Video) Port

Use this 15-pin port to attach an external monitor to your NEC Versa. You can run the LCD display and the external monitor simultaneously or run either alone.

## Serial Port (COM1)

The 9-pin serial port provides a serial interface to which you can connect an RS-232C device such as an external serial printer or modem. A serial mouse is not supported.

## HARDWARE OVERVIEW—INTERNAL COMPONENTS

Review the following sections for a description of the system's internal hardware.

### Battery Pack

The system uses a rechargeable lithium-ion (Li-Ion) battery as its transient power source. The battery pack installs in the compartment next to the VersaBay II on the bottom of the NEC Versa. The battery stores 14.4 volts with a 2600 mAh capacity.

The battery pack powers the NEC Versa for approximately 2 hours. In addition, the user detects how much battery power is available via the percentage displayed on the status bar.

When battery power is getting low, connect the AC adapter to a wall outlet and recharge the battery. It takes approximately 2 hours to recharge the battery whether or not the system is in use.

When battery power is very low, the power LED flashes amber.

### Hard Disk Drive

A standard 2.5-inch 2.1-GB or 3.1-GB hard disk drive ships with the system. The 2.1-GB hard disk drive specifications are listed next.

- Track-to-track seek rate      4 ms
  - Average seek time              13 ms (read) 14 ms (write)
  - Revolutions per minute        4000
  - Data transfer rate              16.6 MB/sec
  - Internal data rates             39.1~61.6 Mbit/sec
-

Increase the system hard disk space by installing another hard disk drive in the VersaBay II slot in the front of the computer using the optional hard disk drive adapter kit.

### **Diskette Drive**

The interchangeable 3.5-inch 1.44 MB diskette drive installs in the front of the system in the VersaBay II slot.

### **Versa Bay II SuperDisk™ LS-120 Drive**

The interchangeable SuperDisk LS-120 drive is a downward compatible diskette drive that can be used with either a 120 MB floptical disk or the a standard 1.44 MB 3.5-inch diskette.

### **20X CD-ROM Reader**

A 20X CD-ROM reader ships with the NEC Versa 6060. The interchangeable twenty-speed CD-ROM reader features the latest in CD-ROM technology. It installs in the front of the system in the VersaBay II slot. The CD-ROM reader is assigned to the next available drive letter. The CD-ROM reader operates at different speeds depending on whether the CD in use contains data or music. This improves video and sound quality.

### **CPU Board**

The CPU board (G8YJKB) is a L-shaped board located above the I/O board. The CPU board also has a fan that exhausts on the right side of the notebook.

The NEC Versa 6060 models ship with Intel's P55CLM/166 MMX installed on the CPU board. The board uses the industry standard PCI interface, with a 66 MHz bus speed.



*Figure 1-11 CPU Board Layout*

---



## Audio Board

The audio board (G8YZK) provides the NEC Versa system with its audio capabilities via line-in jack, and headphone/microphone jacks. It is situated on top of the CPU board. The audio board integrates the following features:

- ESS Technology Plug and Play support
  - ES1869S
  - Integrated Music Synthesis, ESFM™ and Stereo Digital to Analog Converter (DAC) FM Synthesizer
  - 16 bit Stereo with ESFM
  - 4.0KHz to 44.1KHz Sampling Rate
  - Sound Blaster Pro compatible
  - 7 Channel Mixer
  - Integrated Spatializer® 3D stereo sound.

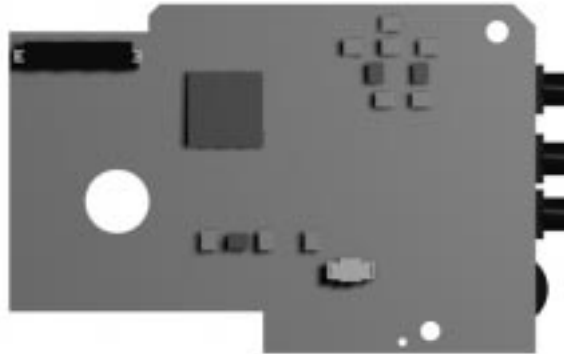

**Figure 1-12 Audio Board Layout**

---

## **AMP Board**

The system Graph board (G8YAN) houses a variety of connectors and controls, including the DIMM connectors. These are identified in the diagram shown in Appendix A.

## **I/O Board**

The system I/O board (G8YKA) contains peripheral subsystems including serial, parallel and video ports, and charger. It is located underneath the CPU board. Refer to Appendix A for a list of connectors.

## **CMOS Battery**

The lithium battery (3 Volts, 280 mAh capacity) is attached to P8 on the I/O board. It provides battery backup and prevents data loss in the system's complementary metal oxide semiconductor (CMOS) RAM. This memory area contains information on the system's configuration like date, time, drives, and memory. The CMOS battery lasts approximately three years.

## **Bridge Battery**

The bridge battery saves the memory contents and system status for at least up to 5 minutes while in Suspend mode. It is connected to the I/O board via connector P9. The AC adapter maintains voltage in the bridge battery when the system is powered on or off. The bridge battery stores 7.2 Volts, 70 mAh.

## **SYSTEM MEMORY**

The Graph board provides 16 MB (5 V EDO) of standard RAM.

Optional memory with a value of 16-, 32-, or 64-MB can be added to increase system memory up to a maximum of 80-MB (60 ns 3.3V EDO access). In addition, 256-KB of read-only memory (ROM), 1 x 28F020, enables the system BIOS to be flashed.

The system provides 2 MB of video.

The following Cache RAM is provided:

- L1: 16 KB (Internal Pentium)
- L2: 256 KB write back (External).

## **Memory Map**

The system supports system and video shadowing, both controlled through complementary metal oxide semiconductor (CMOS). The system supports BIOS as a cacheable area with write protection. Table 1-2 lists the system's memory map.

---

**Table 1-2 Memory Map**

<b>MEMORY SPACE</b>	<b>SIZE</b>	<b>FUNCTION</b>
000000-0003FFh	768 bytes	BIOS Interrupt Vector Table
000400-0004FFh	256 bytes	BIOS Data Area
000500-09FFFFh	640 KB	Applications Memory (used by the OS, device drivers, TSRs, and all DOS applications)
0A0000-0AFFFFFh	64 KB	Video Buffer (EGA and VGA)
0B0000-0B7FFFh	32 KB	Video buffer (monochrome, CGA color, VGA monochrome)
0B8000-0BFFFFh	32 KB	Video Buffer (CGA, EGA color, and VGA color)
0C0000-0CBFFFh	48 KB	Video ROM (EGA and VGA)
0CC000-0CFFFFh	16 KB	Unused, (Reserved for adapter ROMs and other devices requiring ROMs)
0D0000-0DFFFFh	64 KB	Used by Adapter ROMs (i.e., network controllers, hard disk controllers, SCSI host adapters)
0E0000-0EFFFFh	64 KB	Used by System ROM adapters (i.e., network controllers with boot capability)
0F0000h-0FFFFFFh	64 KB	System AMIBIOS (includes Setup and hard disk drive utilities)
100000h-1FFFFFFF	32 MB	Built-in Extended Memory
2000000-5FFFFFFF	64 MB	Extended Memory

## **SYSTEM VIDEO**

The system's LCD operates using the NeoMagic NMG4 Controller. Video signals travel from the controller through the system's 15-pin D-SUB connector.

System video integrates a PCI-bus interface. The system ships with 2 MB Video RAM (VRAM). It supports video modes up to 1024 x 768 with 64K colors in LCD mode.

See Appendix B for a list of video modes.

## **PARALLEL INTERFACE**

The system's parallel interface integrates National Semiconductor's PC87338 chip with a 25-pin D-subconnector. The port is located on the system's rear panel.

The modes of operation available for a PC87338 chip are:

- compatibility mode
- nibble mode

- byte mode
- Extended Capabilities Port (ECP)
- Enhanced Parallel Port (EPP).

The user selects between four parallel interface modes using Auto Setup. These include unidirectional, bidirectional, extended or enhanced. Unidirectional mode sends data output from the standard ISA port only. Bidirectional mode sends data using the standard ISA port or PS/2 technology. Enhanced mode enables high speed data transmission to occur using either the unidirectional or bidirectional modes.

The default parallel port address is 378h and the interrupt level is IRQ07. Pin locations for the parallel interface are listed in Appendix A.

## SERIAL INTERFACE

The RS-232C serial port is a 9-pin D-sub connector on the system's rear panel. The serial port consists of a 16550A and 16450 compatible serial port controller with a programmable baud rate up to 115,200 bps. The serial port connects an RS-232C device or an external modem. The default serial port address is 3F8h (COM1) and the interrupt level is IRQ04.

## NEC VERSA CHIP SET

Refer to Table 1-3 for a quick summary of chip types used in the system. See the Abbreviations section at the beginning of this manual for a translation of chip technologies.

**Table 1-3 NEC Versa Series Chip Types and Technologies**

CHIP	MANUFACTURER	DESCRIPTION	TECHNOLOGY
Intel Pentium P55CLM	Intel	166 MHz CPU	320-pin TCP
82439TX (MTXC)	Intel	M-Triton System Controller	324-pin BGA
82371AB (PIIX4)	Intel	M-PCI IDE ISA Xcelerator	324-pin TQFP
NM2160	NeoMagic	VGA Controller	176-pin FQFP
PC87338	National Semiconductor	Diskette Controller, IDE, Parallel Interface	100-pin TQFP
M38813E	Mitsubishi	Keyboard Controller	64-pin TQFP
PC1131	Texas Instruments	PC Card Controller	208-pin QFP
ES1869A	ESS Technologies	Sound Controller	100-pin PQFP

---

## Intel Pentium P55CLM Microprocessor

The 166 MHz Intel Pentium microprocessor with MMX technology used in the NEC Versa series computer is built on Intel's advanced 2.5V BiCMOS silicon technology. The CPU has on-chip dual-processing, a local multiprocessor interrupt controller, and power management features. NEC adopted the chip specifically for its pipelined Floating Point Unit (FPU), and local interrupt management.

## M-Triton System Controllers

NEC implements Intel's Mobile Triton technology (MTDP 8249TX and MTSC 82371TX) for several of the notebook's subsystems including the DRAM controller, Second Level Cache Controller and PCI Bus interface. The Mobile Triton PCI set features include:

- direct mapped organization write-back policy
- fully synchronous 33 MHz PCI bus interface.

## 256K X Flash ROM

The N28F020 flash ROM is a 32-pin, plastic lead chip carrier (PLCC). The chip allows easy updates to the system's BIOS if needed. More specifically, the ROM is flashed electronically, installing the latest BIOS revisions to the system. It is possible to reprogram the BIOS up to 100,000 times. See Section 2, Setup and Operation, for BIOS update procedures.

The N28F020 provides the system upgrade capability as well as the following:

- 256 KB memory
- Quick-Pulse Programming Algorithm
- 150 nanoseconds (ns) maximum access time
- ETOX Nonvolatile flash technology
- CMOS low power consumption

## **ROM BIOS**

The system uses a Flash ROM known as the system's ROM BIOS to store machine language programs. The BIOS size is 256 KB, consisting of the system utility (for the Auto Setup), system BIOS, video BIOS, and Power Management.

The BIOS programs execute the power-on self-test (POST), initialize CPU controllers, and interact with the LCD indicator panel, diskette drive, hard drive, communication devices and peripherals. The system BIOS also contains Auto Setup and provides VGA controller support. The ROM BIOS is copied into RAM (shadowing) for optimum performance.

The ROM BIOS contains both the system and video BIOS. The system BIOS is located in the upper portion of the device; video BIOS is located in the lower portion. System BIOS is located between F0000h-FFFFFh.

---

The BIOS often changes after the product release to provide enhanced features or bug fixes. To acquire the latest BIOS release, the ROM is flashed electronically allowing the BIOS update to occur without removing the ROM. See Section 2, Setup and Operation, for BIOS upgrade procedures.

## **VGA Controller**

The NeoMagic NM2160 is a PCI 64-bit Graphics Accelerator. The integrated programmable linear address feature accelerates the graphics user interface (GUI) performance. The controller also supports Hardware Multimedia and VESA interface standards. The controller provides advanced power management that helps to minimize power usage in the following modes:

- normal operation
- Standby (sleep) mode
- panel off power saving modes.

## **Parallel Interface**

The PC87338VJG chip is a 100-pin Thin Quad Flat Plastic (TQFP) chip. The controller changes 8-bit parallel data into serial data and writes the data to the diskette. Conversely, the serial data is transmitted from the diskette into parallel data, where it remains until the read operation takes place.

Additional PC87338VJG chip operations include:

- ISA compatibility
- low-power CMOS with enhanced power-down mode

## **Keyboard Controller**

The keyboard controller (M38813E) supports a PS/2-style keyboard, mouse and password security feature. Refer to Appendix A for keyboard interface connector pin assignments.

When data is written to the output buffer, the controller generates an interrupt, and requests the CPU to receive the data. The controller automatically adds an even parity bit to the data sent and waits for a response. The device must acknowledge that the data was successfully received by sending a response to the controller for each byte of data received.

---

## **PC CardBus Controller**

The Texas Instruments PC1131 controller interfaces with the PCI bus, PC CardBus socket and configuration registers to provide:

- compliant with PCI 2.1 and 1995 PC card standards
- CardBus slots with hot insertion and removal
- independent Read and Write buffers for each direction
- burst transfers to maximize data throughput on the PCI CardBus bus.

## **Sound Integrated Circuit**

The ESS Technologies chip (ES1869S Audio Drive) provides dynamic audio circuitry with the following:

- Audio digital processor
  - Plug and Play support
  - High-performance 16-bit Stereo Codec
  - Full-duplex operation for simultaneous record and playback
  - Analog joystick quad timer and digital joystick support.
-

## Interrupt Controllers

Using interrupts, it is possible to change the system's code sequence. To change the sequence, reassign the interrupt-levels. Fifteen interrupts can be used with a cascade connection of two 82C59 interrupt controllers.

Interrupt-level assignments 0 through 15 are listed in Table 1-4, in order of decreasing priority.

**Table 1-4 Interrupt Controllers**

<b>CONTROLELR (MASTER/SLAVE)</b>	<b>PRIORITY</b>	<b>NAME</b>	<b>DEVICE</b>
Master	0	IRQ00	System Timer
Master	1	IRQ01	Keyboard
Master	2	IRQ02	Programmable Interrupt Controller
Slave	3	IRQ08	Real-time Clock
Slave	4	IRQ09	Infrared Port
Slave	5	IRQ10	USB Port
Slave	6	IRQ11	PC Card, Video
Slave	7	IRQ12	PS/2 Mouse
Slave	8	IRQ13	Math Coprocessor (built into CPU)
Slave	9	IRQ14	Hard Disk Controller
Slave	10	IRQ15	IDE DS/MD6000 or PC card in MD6000
Master	11	IRQ03	PC Card
Master	12	IRQ04	Serial Port
Master	13	IRQ05	Sound
Master	14	IRQ06	Diskette Drive
Master	15	IRQ07	Parallel Port

---



## POWER MANAGEMENT OVERVIEW

Power Management in the NEC Versa lets you conserve energy, save battery power, extend the life of your LCD backlight, and protect against data loss due to low battery power.

Set some features to function automatically or activate them manually with the keyboard or a button. It is wise to keep Power Management features enabled, even when using AC power.

The system ships with many power-saving features already enabled. See the following table.

**Table 1-5 Automatic Power-Saving Features**

DEVICE	DEFAULT TIMEOUT	COMMENT
Video	2 minutes	Video turns off after there is no keyboard or VersaGlide input for the specified timeout.
Hard Disk	2 minute	Hard disk motor stops when hard disk is not accessed for specified timeout.
Standby	4 minute	System enters Standby mode after total system inactivity.

You can change the timeout period for any of the devices using Setup. See Section 2 for Setup utility procedures.

Use the **Fn + F7** key combination to set the power management level. The faucet icon changes when the power management setting changes. You can toggle between Highest Performance, Longest Battery Life, Custom Power Management, and Off. Default values change depending on the type of power management you use.



Some power management features are not available when connected to a docking station. For example, the Suspend and Save to File features do not work. The system enters Standby mode if Suspend or Save to File is activated.

## System Power Management

NEC Versa system power management consists of the following operation modes. These modes are:

- **Active Mode** — In active mode, the system uses maximum power. It operates with the default clock speed. The system continues to run at this speed unless overwritten by the power management features.
- **Standby Mode** — The system switches automatically to Standby mode. This eliminates unnecessary power consumption when you operate the system on battery power or AC. Standby mode shuts down the LCD panel, providing privacy as well as power savings.
- **Suspend Mode** — Suspend mode causes the CPU power down, local devices to shut down, and register values to be stored in RAM. System RAM is put into a slow refresh state. A moon icon in the LCD Status Bar indicates that Suspend mode is in effect.

The system resumes Active mode when you press the Suspend button, or the system is set to resume at a certain time of day. Suspend mode lets you save power without first saving the working data.

Press the Suspend button to enter Suspend mode when you need to be away from the system for a short period of time and want to return to where you left off.

In addition, to quickly activate the Save to File feature, press the Fn and Suspend button simultaneously. This shuts down the system, and saves the current working data to a file.

## Local Power Management

Use Auto Setup to select one of four power management settings for local devices. These include Longest Battery Life, High Performance, Custom, and Power Management Off. The power management levels are also available during AC operation. The NEC Versa computer ships with Longest Battery Life as the default power management setting. See Section 2 for specific procedures on using Auto Setup to select the power management settings.

When set to Longest Battery Life, CMOS will set local device timeout values, a local standby timeout value, and a suspend timeout value to ensure the longest battery life. The High Performance setting selects CMOS values that will provide minimal energy savings and a shorter battery life. The custom settings enable end-users to set the timeout values of their choice. The Power Management Off selection terminates all power management timers.

---

Local device timers in the system control power consumption in the LCD and Hard Disk Drive. Table 1-6 shows NEC Versa Series Maximum Performance default power management timers.

**Table 1-6 Maximum Performance Default Settings**

<b>POWER MANAGEMENT MODE</b>	<b>AUTOMATIC SUSPEND</b>	<b>HARD DISK TIMER</b>	<b>VIDEO TIMEOUT</b>
Longest Battery Life	10 minutes	2 minutes	2 minutes
High Performance	30 minutes	10 minutes	10 minutes
Custom	10 minutes	2 minutes	2 minutes

## **PLUG AND PLAY**

The NEC Versa features a Plug and Play functionality. Plug and Play is the ability of the BIOS and/or Windows 95 operating system to dynamically assign system resources to a newly installed device without user intervention.

For example, you can suspend the system, add an external keyboard, mouse, or monitor, and when you resume working, the NEC Versa recognizes the devices that have been connected to it. Similarly, you can remove external devices in Suspend mode and the NEC Versa detects the status when resumed.

---

## SPECIFICATIONS

Table 1-7 provides a complete list of NEC Versa Series system specifications.

**Table 1-7 Specifications**

Item	Specification
<b>Chassis Configuration</b>	
Size	Width: 11.69 in. (297 mm)
	Depth: 9.51 in. (241 mm)
	Height: 2.17 in. (55 mm)
	Weight: 7.1 lb (3.22 kg), Exact weight depends on options
Keyboard	PS/2 compatible, 83-key (U.S.) 79-key (International) with QWERTY-key layout (International keyboards are country-specific)
Device Slots	Two PC Card slots that support up to two optional cards-oriented one on top of the other. Bottom slot is compatible with Zoomed Video.
	One 3 1/2-inch x 0.75-inch high slot, front access, for standard 1.44 diskette drive or SuperDisk LS-120, 20X CD-ROM reader optional hard disk drive or Li-Ion battery.
Power	100 to 240 Volts AC at 50 or 60 Hz
	Output Voltage — 18.5 V DC, 2.45 A (45.5 W)
Battery Pack	Weight — 1.16 lb (527.6g)
	Voltage — 14.4 V
	Capacity — 2600 mAH
	Battery Life — Approximately 2 to 4 hours (depending on model and power management settings)
	Recharging Time — Approximately 2 hours when the system is on or off
Front Panel Controls	Bridge Battery — Backs up memory contents for at least up to 5 minutes in Suspend mode
	Power Button
	Suspend Button
LEDs	Brightness Control
	Power LED
	Battery Status LEDs

**Table 1-7 Specifications**

Item	Specification
<b>System Board</b>	
CPU	Intel Pentium MMX166 MHz/150 MHz with 32 KB L1 cache and built-in numeric coprocessor  L2 Cache Memory = 256K
Clock Speed	166 MHz /150 MHz
CPU Bus Speed	66 MHz /60 MHz
Flash ROM	256 KB: 28F020
Connector Support	Parallel —1 port, 25-pin D-sub  Serial — 1 port, 9-pin D-sub  Infrared — 1 on front of system  VGA — 1 port, 15-pin high-density D-sub  External Keyboard/External Mouse — 1 port, PS/2, 6-pin MiniDin; exclusionary use or both supported with optional Y-adapter  Expansion — 1 port, for optional NEC Docking Station 6000 Plus, optional PortBar 6000 optional MiniDock 6000, or optional FDD Connector Kit.  Mono MIC IN — 1 port, 3-pin, Mini Pin Jack  Stereo Headphones/Stereo Line-Out — 1 port, 3-pin, Mini Pin Jack, .5 watts per channel  Stereo Line-In — 1 port, 3-pin, Mini Pin Jack  USB — 1 port; 4-pin  DC In — 1 port, for AC adapter cable
<b>Memory</b>	
System Memory	16 MB high-speed EDO access, 60 ns
Optional	Two memory module connectors (for expansion memory) under the internal hard drive.  Expandable in 8-MB, 16-MB, 32-MB, 64-MB increments  Maximum 80-MB (by adding a 64-MB expansion Memory card)
Video RAM	2-MB built into VGA
<b>Video Interface (VGA)</b>	
LCD	12.1-inch active matrix thin Film Transistor (TFT) CCFT Super VGA (SVGA) color display, 800 x 600 pixels, 0.306 mm dot pitch, 256,000 colors, XGA at 1024 x 768 x 64K

**Table 1-7 Specifications**

<b>Item</b>	<b>Specification</b>
<b>Internal Device Support</b>	
Diskette Drive	User-removable 3 1/2-inch, 1.44-MB, installs in VersaBay II slot
Hard Disk Drives	IDE interface (built-in), 2 1/2-inch x 1/2-inch high (thin-height) System ships with a 2.1-GB or 3.26-GB hard disk drive
SuperDisk LS-120 Drive	User-removable 3 1/2-inch, 120-MB, installs in VersaBay II slot
20X CD-ROM Reader	User-removable twenty-speed (20X) CD-ROM reader, installs in VersaBay II slot
<b>External Device Support</b>	
CRT	Displays up to 1280 x 1024 resolution x 256 colors
Mouse	PS/2-compatible mouse
Keyboard	Built-in 83 key keyboard with 12 programmable function keys, embedded numeric keypad and special function control keys, dedicated screen control keys, and inverted "T" cursor keys / IBM enhanced 101/102-key compatible keyboard
<b>Software</b>	
Standard	<b>Varies on Operating System</b> Windows® for Workgroups version 3.11, Window 95, Windows NT  McAfee VirusScan™ McAfee WebScan™ LapLink® Traveling Software CompuServe® America Online® MediaMatics Arcade™ MPEG Player Xing MPEG Player
<b>Recommended Environment</b>	
Operation	Temperature: 41° to 95°F (5° to 35°C) Relative Humidity: 20% to 80% (No condensation)
Storage	Temperature: -4° to 104°F (-20° to 40°C) Relative Humidity: 20% to 80% (No condensation)

**Table 1-7 Specifications**

Item	Specification
<b>Administrative Compliance</b>	U.S.: FCC, UL Canada: CSA, DOC Germany: VDE, TUV, CE Australia: AS for AC adapter only
Other Compliance	PC97 Compliance PC95a Compliance Energy Star VESA & PnP VESA PnP ISA

---

## Section 2

---

# Setup and Operation

This section provides setup and operation information for the NEC Versa series system (including cabling, power-on verification and using the Setup utility, from this point on referred to as “Setup” only).

### UNPACKING THE SYSTEM

Find an area away from devices that generate strong magnetic fields (electric motors, transformers, etc.). Place the shipping carton on a sturdy surface and carefully unpack the system. The carton contents include the system, CD-ROM reader, AC adapter, AC power cord, battery, software CDs, and user documentation.

### HARDWARE SETUP

When connecting power and signal cables, do the following.



Always plug the AC adapter cord into an easily accessible outlet.

---

1. Connect the AC adapter cable to the power port on right side of the NEC Versa.
2. Plug one end of the AC power cable into the AC adapter and the other end into a properly grounded 120- or 240-volt wall outlet.

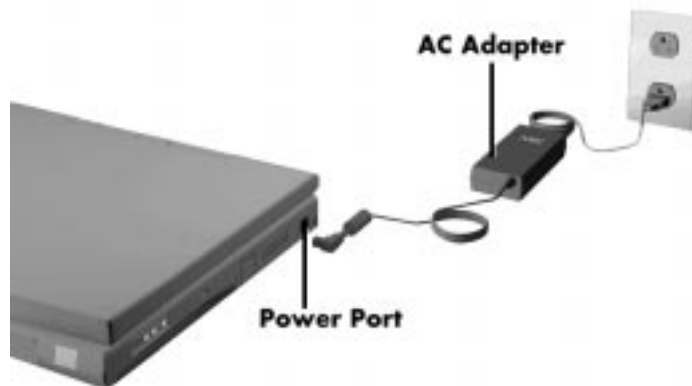

*Figure 2-1 Connecting the AC Adapter*

---





Do not cover or place objects on the AC adapter. This will allow heat to dissipate properly.

---

3. Ensure that all connections are properly seated and secure.



### CAUTION

This equipment uses an ungrounded power cable. Replace the cord if it becomes damaged. U.S. and Canadian replacement cords must be UL-approved (CSA certified in Canada) type SPT-2, 18 AWG, 2-conductor cord with a permanently attached NEMA type 5-15P plug at one end, and a permanently attached connector body on the other. Cord length may not exceed 15 feet. Outside the U.S. and Canada the cord must be rated for at least 250VAC at 10 amps, and must indicate international safety agency approval. The plug must be a type appropriate for the country where it is used.

Obtain replacement cords at an authorized service center. The replacement must be of the same type and voltage rating as the original cord.

4. Slide the power button to the right to power on the computer.



**Figure 2-2 Powering on the System**



If operating the system on DC power, verify that the system has a charged battery pack installed.

---

## Cable Connections

Figure 2-3 shows the external connectors for the system. Where appropriate, secure cables by tightening the cable holding screws.

Table 2-1 describes the I/O connectors on the rear of the system. For pin assignments, see Appendix A.

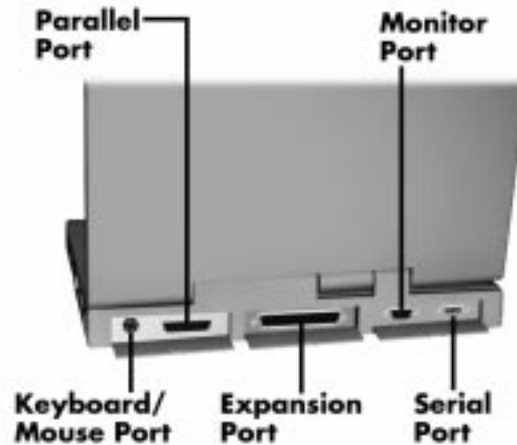

**Figure 2-3** Power and I/O Connector Locations

**Table 2-1** I/O Connector Descriptions

I/O Connector	Function
Keyboard/Mouse Port	Connects to a PS/2-style mouse, or a 101-key, external PS/2-style keyboard.
Enhanced Parallel Port	Connects to a 25-pin parallel device.
Expansion Connector	Provides a 75-pin connector to attach the optional NEC Docking Station 6000, NEC Versa MiniDock 6000 or PortBar 6000.
USB port	Provides a 4 pin connector to attach to a USB device.
Monitor Port	Connects to a 15-pin external CRT.
Serial Port	Provides a 9 pin connector to attach to a RS-232C device.

## POWER SOURCES

The NEC Versa can be powered using three different sources, as follows:

- the AC adapter connected to an electrical wall outlet (using AC power)
- the battery pack or an optional second battery pack
- the optional DC adapter connected to a car cigarette lighter.

The following sections summarize the power sources.

### Using the AC Adapter

Use the AC adapter and power cable that came with the NEC Versa to run the computer on alternating current (AC) power, or to recharge the battery pack. Use the AC adapter whenever a wall outlet is nearby.

**⚠ WARNING**

Do not attempt to disassemble the AC adapter. The AC adapter has no user-replaceable or serviceable parts inside. Dangerous voltage in the AC adapter can cause serious personal injury or death. The AC adapter is intended for use with a computer. Both must meet EN60950 standards.

Keep the adapter connected whenever possible. The AC adapter charges the battery whether or not you are using the NEC Versa.

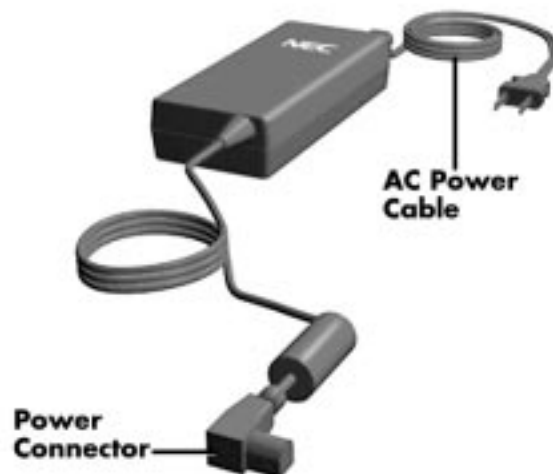

*Figure 2-4 NEC Versa AC Adapter*

---

See the “Hardware Setup” earlier in this section for steps on connecting the AC adapter.

## **Using the Main Battery Pack**

The NEC Versa comes with a rechargeable Lithium Ion (Li-Ion) battery pack. Battery power lasts for approximately two to four hours with power management features enabled. The battery pack is easy to install and remove.

### ***Checking Battery Power Levels***

The NEC Versa system integrates two tools to help the user keep track of the main (or an optional) battery's power level. These include the battery icon located in the tray on the taskbar and Power Profiler utility with Windows NT.

Using the status bar icons (and percentages) to determine battery status is easy. For example, if one battery pack is installed, one battery icon appears. If two batteries are installed, two battery packs appear. A blinking battery icon indicates that the battery is charging. A fast blinking battery icon occurs:

- when installing a new battery
- during unknown battery status
- when there is a problem with the battery.

Similarly, read the percentage that appear next to the battery icon to find out exactly how much battery power is available. The battery percentage icon blinks under the following conditions:

- when battery power is low, the number icon blinks.
- if battery power is extremely low, the number icon blinks rapidly.
- if the battery has been in storage for a long period of time.

To access the PowerGauge utility in Windows for Workgroups systems, select the PowerGauge Utility icon from the NEC Utilities program group. To access in Windows 95 or Windows NT systems, right click the PowerGauge icon located in the tray on the taskbar. It also starts automatically at power on.

### ***What to Do When Battery Power Gets Low***

When battery power is very low, the power LED flashes amber. When battery power gets low, do either of the following:

- Press the Suspend button to put the system in Suspend mode, remove the battery pack, and replace it with a fully charged Li-Ion battery.
-

- Leave the battery pack in the system and connect your NEC Versa to the AC adapter and a wall outlet. If you connect the system to AC power and continue to use it, the battery recharges in approximately 2 hours. If you connect the system to AC power and do not use it, the battery recharges in about 2 hours.

Customers can also buy an optional NEC Versa battery charger to quickly charge the battery. See the online *Versa Tools Catalog* for more information.

### ***Returning the Battery to Full Operation***

To return the battery to its normal state, try the following:

- remove and then reinstall the battery.
- reinstall the battery in the NEC Versa, discharge the battery, then fully recharge the battery (to 100%) if the battery in use was in storage for an extended period of time.

### ***When to Change the Battery***

The following symptoms indicate that battery life is nearing an end. Replace batteries that display these symptoms.

- Shorter work times.
- Discoloration, warping.
- Hot to the touch.
- Strange odor.

### ***Battery Handling***

Keep the following in mind when removing or replacing a battery.

- Use Li-Ion batteries only in the NEC Versa computer for which they are designed.
  - Turn off power to the system after use. Keeping system power on can degrade battery performance and shorten battery life.
  - Clean the battery terminals with a dry cloth when they get dirty.
  - Keep the battery out of the reach of children.
-

 **WARNING**

There is a danger of explosion if the battery is incorrectly replaced. Replace only with the same or equivalent type recommended by the manufacturer. Discard used batteries according to the manufacturer's instructions.

- Keep the battery away from heat sources including direct sunlight, open fires, microwave ovens, and high-voltage containers. Temperatures over 60°C (140°F) may cause damage.
- Do not drop or impact the battery.
- Do not disassemble the battery.
- Do not solder the battery.
- Do not puncture the battery.
- Do not use a battery that appears damaged or deformed, has any rust on its casing, is discolored, overheats, or emits a foul odor.
- Keep the battery dry and away from water.
- Keep metal objects away from battery terminals. Metal objects in contact with the terminals can cause a short circuit and damage.
- If the battery leaks onto skin or clothing, wash the area immediately. Battery fluid can cause a skin rash and damage fabric.
- If battery fluid gets in eyes, DO NOT rub; rinse with clear water immediately and see a doctor.
- Make sure the battery is properly installed in the battery bay.

## Replacing the Battery Pack

Replace the battery pack installed in your NEC Versa system as follows.



Use Li-Ion batteries in the NEC Versa computer for which they are designed. Also, installing another manufacturer's battery, or using a combination of very old and new batteries can deteriorate battery and equipment performance.

1. Save your files, exit Windows, and press the Suspend button or turn off system power.
2. Close the LCD panel and turn the system over.

3. Release the battery cover latch and slide the battery bay cover away from the system.

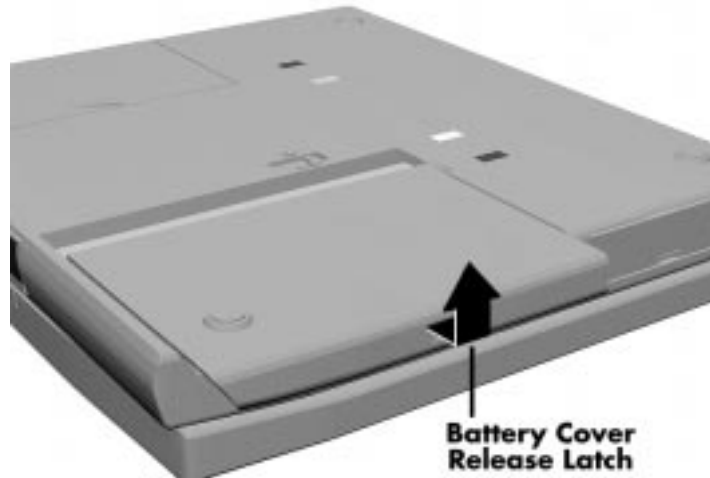

*Figure 2-5 Removing the Cover*

4. Place a finger in the notch on the battery and lift the battery out of the system.

---

**⚠ WARNING**

Always lift the battery out of the system by the notch. Failure to do so can damage the battery terminals.

---

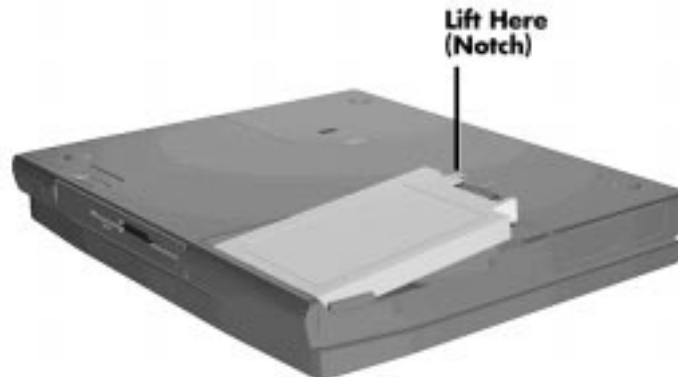

*Figure 2-6 Removing the Battery*

---

5. Locate the grooves on the end of the battery. Lower the notched end of the battery into the battery compartment.

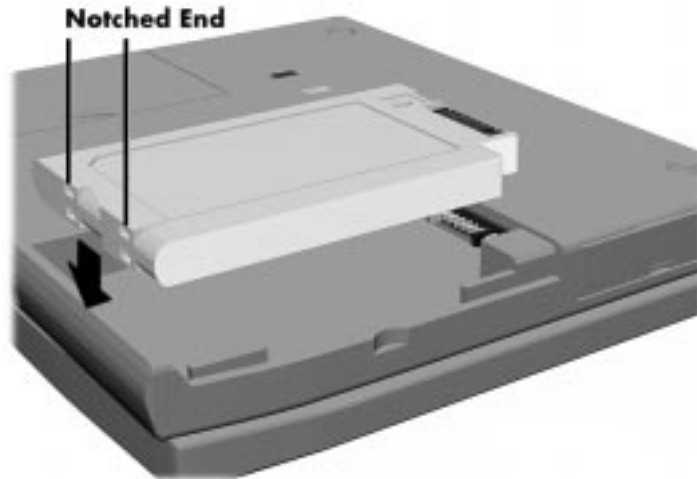

**Figure 2-7** *Inserting the Battery Pack*

6. Replace the battery bay cover as follows:
  - Align the tabs on the bay cover with the grooves on the system chassis.
  - Lower the cover onto the bay and slide it into place, until the release latches lock.



**Figure 2-8** *Replacing the Cover*

---



7. Turn the system over and it is ready to use.

### ***Battery Precautions***

To prevent accidental battery ignition, rupture, or explosion, adhere to the following:



To avoid personal injury and property damage, read these battery precautions on handling, charging, and disposing of Li-Ion batteries.

---

- Keep the battery away from heat sources including direct sunlight, open fires, microwave ovens, and high-voltage containers. Temperatures over 140° F (60°C) may cause damage.
- Do not drop or impact the battery.
- Do not disassemble the battery.
- Do not solder the battery.
- Do not puncture the battery.
- Do not use a battery that appears damaged or deformed, has any rust on its casing, is discolored, overheats, or emits a foul odor.
- Keep the battery dry and away from water.
- Keep metal objects away from battery terminals. Metal objects in contact with the terminals can cause a short circuit and damage.

If the battery leaks:

- If the battery leaks onto skin or clothing, wash the area immediately with clean water. Battery fluid can cause a skin rash and damage fabric.
- If battery fluid gets into eyes, DO NOT rub; rinse with clear water immediately and consult a doctor.
- Take extra precautions to keep a leaking battery away from fire. There is a danger of ignition or explosion.

### ***Recharging Battery Precautions***

Adhere to the following precautions when recharging the Li-Ion battery.

- Read the instructions that came with the battery charger before charging the battery.
-

- Use only the NEC battery charger designed for your NEC Versa battery type. Different NEC Versa models require different batteries and battery chargers.
- Charge the battery for the specified charge time only.
- During charging, keep the environmental temperature between 32°F and 104°F (0°C to 40°C).

### NEC VersaBay II Battery and Adapter Kit (Optional)

The NEC VersaBay II Battery and Adapter Kit provides a second lithium ion (Li-Ion) battery and adapter to use in your NEC Versa computer. Inserting a second fully charged battery increases battery life approximately 4 to 8 hours.

See the online *Versa Tools Catalog* in the NEC Versa 6060 Help Center, for more information.

### Extending Battery Life

While on the road, it is important to be aware of the simple things you can do to extend the life of the system's main battery. One way is to keep the LCD backlight setting to Standard instead of Full. You can toggle between these two settings by pressing the function keys, **Fn - F5**. Or, slide the backlight control to a dimmer level.

### Using the DC Car Adapter

Another way to power the NEC Versa is via car battery power using the optional DC car adapter. Connect the system to the optional DC car adapter as follows.

1. Disconnect the AC adapter from the system if connected.
2. Plug the appropriate end of the car DC adapter into the power port on the system.
3. Connect the plug of the DC car adapter to a car cigarette lighter.



**Figure 2-9** Connecting the Car DC Adapter

## OPERATING CONTROLS

The following section describes system controls, the LEDs, and function keys.

Table 2-2 describes the controls.



**Figure 2-10 Keyboard Panel LEDs and Controls**

**Table 2-2 Control and Switch Functions**

Control	Function
Status Bar	The status bar provides an easy way to detect system status. Different graphic icons appear on the LCD bar indicating that a device is accessed, an operation performed, or a power mode is activated.
Power LED	Lights green when the computer is powered on. Lights amber and blinks at low battery levels.
Suspend/Resume Button	Press the button for Suspend mode, press again to resume active mode.
Power Button	Turns the system on when pushed to the right. Turns the system off when pushed to the right again.
Hard Disk Drive Bay Release Latch	Lift latch to remove the hard disk drive installed in the system.
Kensington Lock	Enables the user to add an optional Kensington Lock to prevent unauthorized use of the computer.
Volume Control	Controls the speaker or headphone volume.
Headphones/Line-Out	Connects external headphones, speakers or other audio devices to the NEC Versa. Plugging in this port disables the built-in system speakers.
Line-In	Use a cable to connect to the Line-Out port on another audio system.
Microphone	Allows the user to record monophonic sound directly into the NEC Versa system.
AC Port	Use the power jack to attach the NEC Versa to a DC power source.

## Status Bar

The NEC Versa status bar is located in the upper left corner of the keyboard panel. Figure 2-11 shows the status bar.

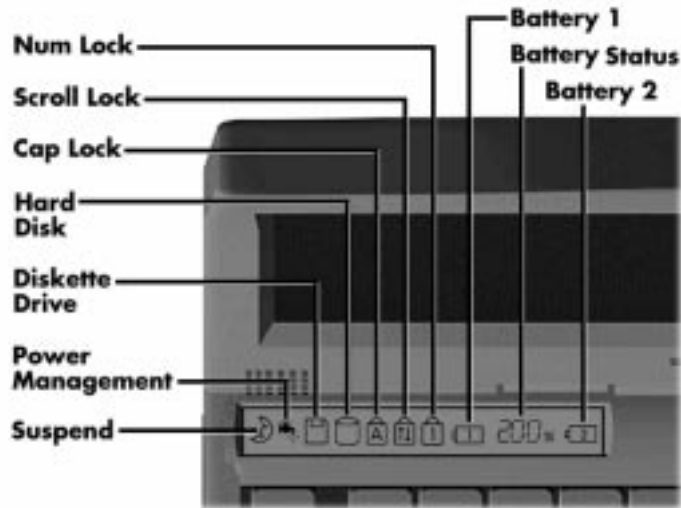

**Figure 2-11** Status Bar Location

## Status Icons

The NEC Versa uses eight icons to let the user determine system status, as follows.

- Suspend — appears when the system is in Suspend mode.
- Power Management — shows current power management mode.
- Diskette Drive — appears when the NEC Versa writes data to, or retrieves data from a diskette or SuperDisk LS-120.
- Hard Disk — shows when the NEC Versa writes data to, or retrieves data from the hard disk drive.
- Caps Lock — appears when Caps Lock is used.
- Scroll Lock — indicates that Scroll Lock is used.

- Num Lock — indicates that Num lock is in effect.
- Battery Status — displays the total percentage of battery power available.
  - Battery 1 appears when you have one or more batteries installed.
  - Battery 2 appears when you have an optional battery installed in the VersaBay II.

## Function Keys (Fn Keys)

Function keys set specific system parameters and are built into the ROM. When using these keys, simultaneously press **Fn** and the corresponding function key. See Table 2-3 for a list of ROM-based hot keys. ROM-based hot keys change system parameters temporarily. Hot Key functions operate until the system is turned off or reset.

**Table 2-3 FnKey Operations**

Key	Function
Fn F2	Highlight, toggles the contrast between standard and full.
Fn F3	LCD/CRT, toggles between LCD, CRT and simultaneous modes.
Fn F4	Standby, toggles between ON/OFF
Fn F5	Backlight, toggles the backlight between standard and full
Fn F6	Speaker Volume, toggles speaker volume between high, medium, low and off.
Fn F7	Power Management (P/M), sets P/M levels to highest performance, longest battery life, custom values, or off.
Fn F8	Graphic Expansion, toggles between ON/OFF
Fn F12	Scroll/Lock On/Off
Fn Suspend	Save To File On Demand

## Smart Power Switch

Provides an automatic feature that prevents you from accidentally powering off the NEC Versa, and losing your data while your system is in Suspend mode. The smart power switch senses that the system is in Suspend mode and prevents you from directly powering off the system when you press the power switch.

To power off the system from Suspend mode,

1. press the Suspend/Resume button to make the system active.
  2. press the Power button to turn off the system.
-

## Dip Switch

A six-position dip switch is located next to the hard disk drive connector in the hard disk drive bay. The following lists each switch setting and its special function.



Switch settings 3, 4 and 6 are reserved for NEC factory use only.

---

- Switch 1, BIOS Flash Protection Switch — The default setting is “ON.” Change the setting to “OFF” when you update the system’s basic input/output system (or BIOS) flash memory. See “Updating the BIOS” next, to complete this procedure.
- Switch 2, Password Override Switch — The default setting is “OFF.” For example, if the customer forgets their password and cannot access data, change the setting to “ON” and your current password is removed.
- Switch 3 — Reserved for factory use.
- Switch 4 — Reserved for factory use.
- Switch 5 — Not used.
- Switch 6 — Reserved for factory use.

### **Updating the System BIOS**

Use the following steps to update the NEC Versa system BIOS with the BIOS Update diskette (BUD). Specifically, the BIOS is the code transmitted onto your system’s micro-processor, or central processing unit (CPU).



You only need to update the BIOS if NEC makes significant improvements or fixes to the current system BIOS.

---

If you determine that the default BIOS needs an upgrade, to receive a copy of the BUD contact the NECCSD Diskette Fulfillment Center at (800) 842-6446, or the NECCSD Customer Service (888) 632-9128, Fax (978) 635-4666, or the NECCSD Bulletin Board (978) 635-4706.



You should only use the BIOS upgrade diskette for the specific model.

---

1. Check that computer power is off. Turn the NEC Versa upside down with the front of the unit facing you.
2. Remove the hard disk drive.
3. Locate switch 1 on the six-position dip switch in the hard disk drive bay.



**Figure 2-12 Locating the Switch Settings**

4. Set the switch to “off” to enable BIOS reprogramming.
5. Replace the hard disk drive and the compartment cover.

Now you are ready to begin the actual update procedure using the following steps.

6. Make sure that power is off, and the notebook is not docked. Insert the BIOS Update diskette into diskette drive A. Plug the AC adapter into the system and a wall outlet.
7. Power on the computer with the diskette in drive A. The computer boots and automatically loads the utility. A message similar to the following may appear:

Warning: You are about to modify your AMI BIOS.  
Press **Ctrl – C** to exit. Press any key to Continue.

---

**NOTE** Always load CMOS default setting after flashing BIOS.

---

8. Press **Enter** to continue.

The utility displays the BIOS filename and a warning message concerning flash procedures. Press **Y** to continue, **N** to reboot.

9. When the update is complete, reset the dip switch to the “on” position, and enter Setup to restore the default parameter settings.

### ***Customizing BIOS Message***

The BIOS Message may be customized with a the BIOS Update diskette (BUD). Specifically, the BIOS is the code transmitted onto your system’s microprocessor, or central processing unit (CPU). This Customization Process allow up to 4 lines and 80 characters per line to appear on the screen during BootUp.

1. Follow Steps 1 through 7 as described previously in “Updating the System BIOS.”
2. Power on the unit and follow the on-screen instructions.
3. When the update is complete, reset the dip switch to the “on” position, and enter Setup to restore the default parameter settings.

To receive a copy of the Customizing BUD contact the NECCSD Diskette Fulfillment Center at (800) 842-6446, or the NECCSD Customer Service (800) 632-4525 or (888) 632-9128, Fax (978) 635-4666, or the NECCSD Bulletin Board (978) 635-4706.

## **POWER-ON SELF-TEST (POST)**

Each time the system is powered on, the system checks the working status of components through an automatic power-on self-test (POST). The test checks the system configuration for any discrepancies. One beep means that POST is successful. If any problems in data transfer or hardware exist, an error message appears.

If the message is an Invalid Configuration message, press **F1** to enter the Setup utility. The system collects Setup data and lists the changes detected in the current parameter settings, that can be seen in Standard CMOS Setup. Press **Enter** to review the settings, and make any necessary corrections.

If no error messages appear but the system still malfunctions, check the items in the list below.

- The power switch for each peripheral is on.
  - All cables and power cords are tightly connected.
  - The electrical outlet is working.
  - The brightness and contrast controls for the display are adjusted properly.
-



- All options have been properly installed.



---

If the system parameters (date, time, options, etc.) have not been entered for the present configuration, enter them when you complete the setup procedures (see “System Parameters” in this section).

---

## POST Errors

Error messages will appear during POST when configuration information does not match the settings stored in memory. Error messages will also appear if the system loses the configuration information due to hardware failure.

Refer to Table 2-4 for a description of POST error messages.

**Table 2-4 POST Error Messages**

MESSAGE	WHAT TO DO
Invalid system disk	Replace the disk and then press any key.
Diskette boot failure	Insert a bootable disk in drive A and press any other key.
Non-system disk or disk error; Replace and press any key when ready	Remove the diskette from drive A and press any key to start the system from the hard disk. Or, insert a bootable disk in drive A and press any key.
Operating System Not Found or C: drive failure	Press <b>F2</b> to start Setup. Change the hard disk type to the correct setting. Exit and save Setup changes.
Invalid configuration information – run Setup program	One or more system configuration parameters are not properly set. Start Setup, set them correctly, and exit and save to update the parameters.
Real time clock failure	Set time and date using Setup. Exit and save to update the parameters.
CMOS date and time not set	Set the time and date using Setup. Exit and save Setup changes to update the parameters.
System CMOS Checksum failure – run Setup Press (F1) to resume.	Press <b>F2</b> to enter Setup. Under Exit, set the default values. Under Main, set the date and time. Save your changes and exit.

**Table 2-4 POST Error Messages**

MESSAGE	WHAT TO DO
Fixed disk configuration error	Start Setup. Exit and save to update the parameters. Check to see if the hard disk connector is seated properly. If there is still a problem, the hard disk might need repair.
C: drive error or failure	Press <b>F2</b> to start Setup. Exit and save to update the parameters.  Check to see if the hard disk connector is seated properly.  If there is still a problem, the hard disk might need repair.
Hard Disk controller failure	Press <b>F2</b> to start Setup. Exit and save to update the parameters.  Check to see if the hard disk connector is seated properly.  The hard disk controller does not work and might need repair.
Keyboard controller failure	Unplug external keyboard if attached and reboot the system. If it still fails, have the system repaired.   Repeated keystrokes during boot may produce an error message.
Keyboard Error	A timing problem exists with the keyboard. If the error message remains, the keyboard may have to be repaired.
KB\interface error	Error exists in keyboard connector. If the error message remains, the keyboard may have to be repaired.

---

 If a display related error occurs it is indicated by beeps. Display related errors usually require a system board replacement.

---

## SETUP UTILITY

The Setup utility is a ROM-based program. It is functional when enabled (factory default). Setup automatically detects current system parameters during the power-on self-test (POST), described in the previous section. It also provides the following functions:

- sets date and time
- signals any hardware discrepancies during POST via error messages
- verifies that any optional memory that you installed was installed correctly
- integrates user defined security features.

## Accessing Setup

To access Setup, press **F2** at the power-on prompt

### *With an Error at POST*

You will need to use the Setup utility if the system detects an error during POST, it prompts you with double beep sound and a message: "Press <F1> to Run SETUP."

### *With No Errors at POST*

To enter Setup when no error message is displayed during POST, press **F2** when the prompt appears.

## Setup Utility Main Menu

After you press **F2**, the system displays the Setup Main Menu screen, similar to the following.

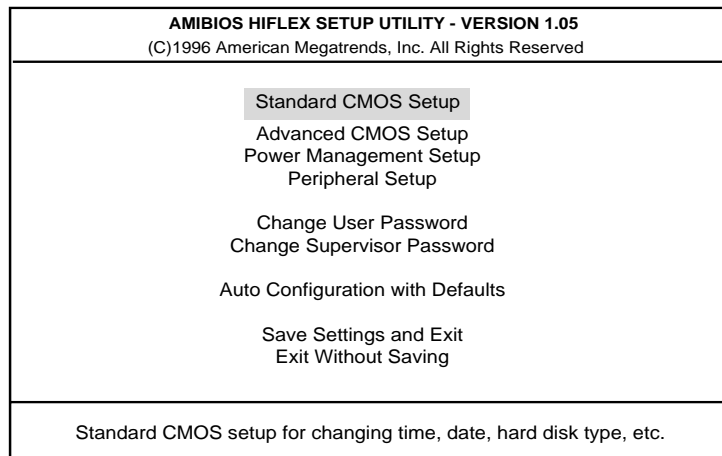

**Figure 2-13 Setup Main Menu**

Use the up and down arrow keys (located on the lower right corner of the keyboard) to toggle through the Setup menu items.

---

## How to Use Setup

The following sections describe how to use Setup, including these topics:

- Looking at screens
- Using keys
- Checking and setting system parameters.

## Looking at Screens

Setup screens have three areas as shown next.

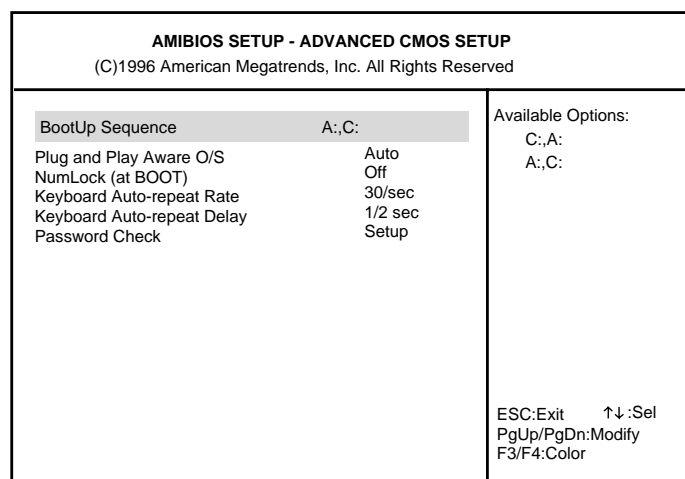

**Figure 2-14 Advanced CMOS Setup Menu**

- **Parameters**  
The left part of the screen. This area lists parameters and their current settings.
- **Available Options**  
The right part of the screen. This area lists alternate settings.
- **Key Legend**  
The bottom right corner of the screen. These lines display the keys that move the cursor and select parameters.

**Using Keys**

The following table lists Setup keys and their functions.

**Table 2-5 Setup Key Functions**

Key	What It Does
↑ ↓	Moves the cursor between the displayed parameters.
PgUp/PgDn	Modifies the current parameter settings.
Tab	For some parameter settings, moves the cursor between the subfields. For example, for System Time, Tab moves the cursor from hour to minute to second.
Esc	In the Main Menu screen, press Esc to display the "Quit without saving" prompt. Also, press Esc to exit Setup menus, and return to the Main Menu.
F3/F4	Changes the screen color.

**Checking/Setting System Parameters**

See the following table for a list of parameters, their factory default settings, and alternate settings. A description of each setting follows the table.

To reset all parameters to the default settings, select Auto Configuration with Defaults from the Setup Main Menu and press **Y**.

**Table 2-6 Setup Parameters**

Parameter	Default Setting	Alternate Setting(s)
<b>Standard CMOS Setup</b>		
System Date	mm/dd/yyyy	
System Time	hh:mm:ss	
Diskette Drive A: **	1.44MB, 3 1/2"	Not Installed 1.2 MB, 5 1/4" 1.44 MB, 3 1/2"
Diskette Drive B: *	Not Installed	1.2 MB, 5 1/4" 1.44MB, 3 1/2" Not Installed
Internal Hard Disk Drive	Enabled	Disabled Enabled
Int Master	Auto	Not Installed BIOS Defined User Defined Auto CD-ROM LS-120

**Table 2-6 Setup Parameters (cont'd)**

Parameter	Default Setting	Alternate Setting(s)
Int Slave	Auto	Not Installed BIOS Defined User Defined Auto CD-ROM LS-120
Docking Station Hard Drives*	Enabled	Disabled Enabled
Ds Master *	Auto	Not Installed BIOS Defined User Defined Auto CD-ROM LS-120
DS Slave *	Auto	Not Installed BIOS Defined User Defined Auto CD-ROM LS-120
Boot Docking Station IDE *	No	Yes No
System Memory	16MB	(Auto detect)
<b>Advanced CMOS Setup</b>		
Plug and Play Aware O/S	No	No Yes Auto
Bootup Sequence	A:, C:	C:, A: A:, C:
Docking Station Video	Dock Stn.	Portable Dock Stn
BootUp NumLock	Off	On Off
Graphic/Text Panel View	Off	Off
Expansion		On
Password Check	Setup	Setup Always

**Table 2-6 Setup Parameters (cont'd)**

<b>Parameter</b>	<b>Default Setting</b>	<b>Alternate Setting(s)</b>
<b>Power Management Setup</b>		
Power Management Under AC	Off	On
Power Savings Level	Longest Life	Off Custom High Perform Longest Life
Hard Disk Timeout ***	2 min	Off 5, 30 or 45 sec, 1, 2, 4, 6, 8, 10, 15 min
Video Timeout ***	2 min	Off 30 or 45 sec, 1, 2, 4, 6, 8, 10, or 15 min
Peripheral Timeout ***	ON	Off On
Audio Device Timeout ***	On	Off On
Standby Timeout ***	4 min	Off 1, 2, 4, 6, 8, 10 or 15 min
Auto Suspend Timeout ***	10 min	Off 5, 10, 15, 20, 25 or 30 min
Suspend Option	Suspend	STF (Save-To-File) Suspend
Auto Save To File	Enable	Disable Enable
Panel Backlight	Auto	Full Standard Auto
Suspend Warning Tone	On	Off On
Modem Ring Resume	On	Off On
Wake Up Alarm	Off	On Off
Resume Alarm Time	8:00 AM	12:00 AM to 11:55 PM, 5 min. increments

**Table 2-6 Setup Parameters (cont'd)**

Parameter	Default Setting	Alternate Setting(s)
<b>Peripheral Setup</b>		
Serial Port	Auto	Disabled COM1, IRQ4 COM2, IRQ3 COM3, IRQ4 COM4, IRQ3 Auto (PnP OS Setup)
Parallel Port	Auto	Disabled LPT1 LPT2 Auto (PnP OS Setup)
Parallel Mode	ECP	Uni-Directional Bi-Directional EPP ECP
IR Serial Port	Auto	Disabled COM2, IRQ3 COM3, IRQ9 COM4, IRQ3 Auto PnP OS Setup
IR Serial Mode	FIR	SIR MIR FIR
Sound	Auto	Disabled IO address 220h, 240h, 260h, 280h Auto (PnP OS Setup)
Sound IRQ	N/A	5, 7, 9, 10, 11
SB-Compatible DMA	N/A	DMA #0, DMA #1, DMA #3
Full Duplex Mode DMA	N/A	DMA #0, DMA #1, DMA #3
Docking Station Midi (MPU-401) ****	N/A	Disabled
Docking Station Joystick ****	Auto	300h, 310h, 320h, 330h Disabled Auto PnP OS Setup

\* Only visible when cold docked.

\*\* When the portable diskette drive is present, the portable diskette drive is the bootable diskette drive.

\*\*\* Only changeable when power saving is set to Custom.

\*\*\*\* Only assessible when docked.



## Setup Menus

Read the following descriptions for an explanation of each item that appears in the Setup menus, as listed in the preceding table.

### Standard CMOS Setup

When you select the Standard CMOS Setup screen you will see System Time and System Date parameters as well as drive parameters.

- **Date/Time**

Lets you set your NEC Versa's calendar month/year and system clock. The calendar clock is year 2000 compliant. These settings remain in memory even after you turn off system power.

To set the date use the Tab key to move from field to field. Use the Pg Up or Pg Dn key to change the numbers within each field.

To set the time, enter the current hour, minute, and second in *hr/min/sec*, 24-hour format. Use the Tab key to move from field to field. Use the Pg Up or Pg Dn key to change the numbers within each field.

- **Drives**

The drives parameter let you check and change settings for your drives, including internal hard drives, diskette drives, and CD-ROM reader. This parameter also lets you check the docking station's hard drives, diskette drives, and CD-ROM reader.

### Advanced CMOS Setup

Sets CMOS settings for the following functions.

- **Plug and Play Operating System**

Allows the selection of a Plug and Play aware system to operate at bootup.

- **BootUp Sequence**

Sets the order that the drives (A:, C:) initialize, or sets the order to search for the boot disk.

- **Docking Station Video**

Sets the video controller when the notebook is docked.

- **BootUp Num-Lock**

Selects NumLock On or Off at system startup.

- **LCD Panel View Expansion**

Expands or compresses the on screen viewing area. When in expand mode the graphic/text quality may be adversely affected.

---

- Password Check

When the system prompts you to enter a password, the password is verified. If Always is selected, pressing Ctrl-Alt-Backspace will lock up the keyboard until the password is entered. The Num Lock, Cap Lock and Scroll Lock LED's will flash in sequence until you enter the password.

### Power Management Setup

The Power Management Setup menu lets you balance high performance and energy conservation using parameters including the following.



Some operating systems such Windows 95 and Windows NT have their own power management software which overrides CMOS settings. In this case, be sure to set your desired power management settings accordingly.

---

- Power Management Under AC

Normally, whenever AC power is connected to your NEC Versa system, power management is disabled. If you enable this parameter, the system automatically activates the power management profile you set.

- Power Savings Level

A High Perform setting provides the greatest system performance. Longest Life provides maximum power saving, and Off disables all device timeouts. You can also customize power management by selecting Custom Settings and entering values for device timeouts.

- Hard Drive Time-out

Allows you to select the amount of time before your hard drive shuts down when Power Management is set to Custom.

- Video Time-out

Allows you to select the amount of time before your video shuts down when Power Management is set to Custom.

- Peripheral Time-out

If this feature is On, onboard serial, parallel, diskette or SuperDisk LS-120 devices are power managed after 2 seconds of inactivity.

- Audio Device Timeout

If this feature is On, the audio device turns off when no sound device activity occurs for 30 seconds.

---

- **Standby Timeout**  
You can specify when the system enters Standby mode after total system inactivity.
- **Auto Suspend Timeout**  
You can select the system suspend timeout period. If no system activity has occurred for the specified timeout, the system will enter the selected Suspend Option.
- **Suspend Option**  
Suspend mode is the default power management mode. When you select Suspend, after a specified amount of inactivity, your NEC Versa shuts down all devices as specified by the user in Setup (or applies default timeouts). All your data is automatically recovered from where you left off when you Resume.
- **Auto Save to File (STF)**  
The system enters STF after 30 minutes in Suspend mode.
- **Panel Backlight**  
Lets you choose the backlight intensity.
- **Suspend Warning Tone**  
This parameter lets you enable or disable a warning tone when Suspend mode starts. It is best to keep this option On.
- **Modem Ring Resume**  
Lets you choose whether the system resumes automatically when the external serial port modem receives a transmission.
- **Wake Up Alarm/Resume Alarm Time**  
Lets you set a resume time from Suspend mode.

### **Peripherals Setup**

The Peripherals Setup menu displays the connection location between the system and the Input/Output (I/O) ports.

- **Serial Port**  
Disables or reassigns the serial port.
  - **Parallel Port/Parallel Mode**  
Disables or reassigns the parallel port, and/or select a parallel port mode.
  - **IR Serial Mode**  
Allows you to select the IR transfer rate.
  - **Sound/Sound IRQ/SB-compatible DMA/Full duplex Mode DMA/Docking Station Midi (MPU-401)**  
Adjusts the sound parameter to user defined, disabled or Auto. Change additional sound related items as needed.
-

- **Docking Station Joystick**  
Adjusts the parameter to Disabled, Auto, or Plug and Play Operating System as needed.

### **Change User Password**

You must set the Supervisor password first. Then you can set the user password. You can have a supervisor password without having a user password. This gives the system a second level of password security.

### **Change Supervisor Password**

Sets a Supervisor password at system startup.

### **Auto Configuration with Defaults**

Loads or cancels default settings.

### **Save Settings and Exit**

Accepts changes made to current, or default settings and exits Setup.

### **Exit Without Saving**

Reverts to the previously selected settings and exits Setup.

## **Using Setup to Set Power Management**

As you have seen in this chapter, Setup allows you to use the factory set power savings level (Longest Life), or choose between High Perform, Custom, or Off. Each provides a special value to your current work effort. These power management levels have been designed with you in mind. For example, you can use them under the following circumstances:

- **Longest Life** — Provides best battery life and good performance. Use while traveling long distances.
- **High Perform** — Provides best performance and good battery life. Use while on the road, traveling short distances.
- **Custom** — You decide! Set power management levels according to your own needs and present environment.
- **Off** — Office environment, using AC power.

See the online documentation in the Windows NEC Information group under the NEC Versa 6060 Help Center for a more detailed discussion of Power Management. See the following section for information on how using the special Save to File (STF) feature can benefit you.

---

### ***Using the Save to File (STF) Feature***

STF is a feature that protects the integrity of your working files. For example, if you get urgently called away from your system without saving the current data, it automatically goes into Suspend mode. After 30 minutes pass, and you don't return, your working environment is saved to a special file on your hard disk.

There are two ways to set your NEC Versa's STF feature. One method is via the Setup utility. Select Power Management from the Setup Main Menu. Move the cursor down and highlight Suspend Mode. Press the **PgUp** key and select STF. Save the settings and exit Setup.

The second method is to press the **Fn Suspend** buttons simultaneously, before you leave your NEC Versa. This function initiates STF on demand.



When the status bar reads that there is only 3% power remaining in the system, the NEC Versa automatically performs a STF.

---

### ***STF Benefits***

Using STF can benefit you in the following ways.

- When in STF, there is minimum battery drain.
- Preserves the life of your NEC Versa.
- Saves you time. When you return from that urgent call or meeting, you don't have to perform a full reboot. You will only have to press the Power button.

---

## AUTOMATIC POWER-SAVING FEATURES

Table 2-7 lists the NEC Versa series automatic power conserving features. These features work during battery and AC operation. The features listed below do not work when the optional docking station is connected.

The default timeouts listed below can be changed using Setup.

Use the **Fn F7** key combination to set the power management level. You can toggle between Highest Performance, Longest Battery Life, Custom Power Management, Low, and Off. You can modify the custom level for your specific working environment using Custom. Default values change depending on the type of power management you use.

**Table 2-7 Automatic Power-Saving Features for Longest Life Option**

Device	Default (timeout)	Description
Vedio backlight	2 minutes	When no keyboard or NEC VersaGlide input occurs for the specified timeout, the LCD backlight shuts off.
Hard Disk	2 minutes	Hard disk motor stops when not accessed for specified timeout.
Auto Suspend Timeout	10 minutes	The system enters Suspend mode after total system activity.

---

## Section 3

---

# Troubleshooting

This section focuses on providing you with some information on basic troubleshooting as well as how to translate some system error messages.

### QUICK TROUBLESHOOTING

This section summarizes problems that may develop during system operation and lists suggested corrective actions.

*Table 3-1 Quick Troubleshooting*

Problem	Corrective Actions
No power	<p>Check that the AC adapter is plugged into the power connector of the system. Also, check that the AC adapter is plugged into a properly grounded AC power outlet.</p> <p>If using the battery as the main power source, check if the battery pack is the right type, is charged, and is inserted correctly.</p> <p>Check the I/O board of the system. Is it inserted into the CPU board connector properly? Otherwise, replace the I/O board.</p>
Data on the LCD is unreadable	<p>Adjust the brightness control on the right side of the LCD panel.</p> <p>Check LCD Panel View Expansion in BIOS, Press <b>Fn-F8</b> to toggle Panel View Expansion</p> <p>Check if the LCD cables are inserted properly. Also, check connections inside the LCD panel.</p> <p>Check if installed VGA driver is correct.</p> <p>Check LCD Panel View Expansion in BIOS, Press <b>Fn – F8</b> to toggle panel view expansion</p> <p>Check the VGA controller chip on the I/O board for any loose soldering.</p> <p>Replace the CPU board.</p>

**Table 3-1 Quick Troubleshooting (cont'd)**

<b>Problem</b>	<b>Corrective Actions</b>
Battery power does not last long	<p>Make sure that the power management features are enabled.</p> <p>Recharge the battery pack for 2 hours or up to 100% before using again.</p> <p>Replace the battery pack.</p>
System halts during boot sequence	<p>Check condition of selected boot device (diskette, hard disk or CD-ROM) for bad boot track or incorrect OS files.</p> <p>Try booting from a new bootable diskette and re-copy or repartition hard disk.</p> <p>Check for any BIOS error messages on the display screen.</p> <p>Replace the CPU board or I/O board.</p>
I/O processing malfunctions	<p>Check the connections of all internal devices.</p> <p>Replace the CPU board or I/O board.</p>
Diskette drive does not work	<p>Check if diskette drive cable is connected properly.</p> <p>Check if the diskette drive works in the external FDD Connector Kit or with the PortBar 6000.</p> <p>Check diskette type if correct and not faulty.</p> <p>Replace the diskette drive.</p> <p>Replace the I/O board.</p>
Hard disk drive malfunction	<p>Check if hard disk drive is set properly on CMOS SETUP.</p> <p>Check drive connections.</p> <p>Check if disk drive is good.</p> <p>Replace the CPU board or I/O board.</p>
Memory malfunction	<p>Check if the memory module is inserted properly.</p> <p>Replace the memory module.</p> <p>Replace the CPU board.</p>
External keyboard or PS/2 mouse doesn't work	<p>Check if keyboard or mouse are connected properly. Check Y-adapter if it is being used. Power off system first before plugging in the device.</p> <p>Replace the keyboard or mouse.</p> <p>Replace the CPU board or I/O board.</p>



**Table 3-1 Quick Troubleshooting (cont'd)**

<b>Problem</b>	<b>Corrective Actions</b>
PC card does not work	<p>Check the PC card driver installation for any IRQ or I/O address conflict.</p> <p>Check if the PC card is inserted properly and all connections are set.</p> <p>If the PC card is a Type II card, install it in the system's other PC card slot.</p> <p>Replace the PC card.</p> <p>Replace the I/O board.</p>
NEC VersaGlide doesn't work	<p>Check if PS/2 or Logitech mouse driver is properly installed.</p> <p>Check VersaGlide cable inside the system if it is inserted properly.</p> <p>Remove VersaGlide and clean it.</p> <p>Check the keyboard controller chip for any cold or loose soldering.</p> <p>Replace the CPU board.</p>
Serial device does not work	<p>Check if mouse driver is installed properly.</p> <p>Check if serial device is connected properly.</p> <p>Check the device drive installation for any IRQ or I/O address conflict.</p> <p>Replace serial device.</p> <p>Check the I/O controller chip on the main board for any cold or loose soldering.</p> <p>Replace the I/O board.</p>
Parallel device does not work	<p>Check all connections.</p> <p>Check if external device is turned on.</p> <p>Check the device drive installation for any IRQ or I/O address conflict.</p> <p>Test another parallel device.</p> <p>Check I/O controller chip on the main board for any cold or loosed soldering.</p> <p>Replace the I/O board.</p>

## HELPFUL QUESTIONS

Here are some helpful questions to ask when troubleshooting the notebook:

- Is there any external power source connected to the computer?
  - Is the battery fully charged?
  - Is the computer turned on and the Power LED activated?
  - Are the LCD display controls set to the minimum level?
  - Is the LCD display switched to the external monitor?
  - Are all cables and devices connected properly and securely?
  - Are all needed device drivers installed properly?
  - Have you checked the AUTOEXEC.BAT and CONFIG.SYS files for errors?
  - Is the Suspend Mode activated on the LCD Status Bar? Press any key or press the Power switch to power on the system.
-

## Section 4

---

# Field Service Guidelines

This section contains preventive and corrective maintenance procedures for the NEC Versa 6060 notebook.

The first part of the section describes cleaning procedures and preferred handling procedures for sensitive components (for example disk drives, batteries).

The second part of the section identifies all field replaceable parts with the remainder of the section containing the removal and replacement procedures for the field replaceable parts.

### PREVENTIVE MAINTENANCE

Preventive maintenance is limited to cleaning the plastic case, the keyboard, and the display screen and cleaning the diskette drive heads as required.



Remove the battery and disconnect the AC adapter before performing any maintenance. Voltage is present inside the system unit and LCD even after the system is turned off.

---

### Cleaning the Notebook's Exterior

Use the steps below to clean the outer surface of the system.

1. Power off the system and remove all battery packs. Unplug all cables connected to the system.
  2. Wipe the outside of the system unit, keyboard, and display with a soft, clean cloth. Remove stains with a damp, almost dry cloth. Use glass cleaner to clean the LCD indicator panel. Apply the glass cleaner directly to the cloth and then wipe the LCD indicator panel. Do not use solvents or strong, abrasive cleaners on any part of the system.
  3. Clean the keys with a damp cloth. A small, soft-bristle brush may be used to clean between the keys. Make sure to use a damp cloth (not wet) to prevent moisture from seeping between the keyboard and the metal plate, possibly damaging the components under the keys. If the keyboard gets wet, thoroughly dry it before re-assembling the system unit.
-

## **Cleaning the Notebook's Interior**

When servicing the inside of the notebook, remove dust and other foreign particles from inside the system unit as follows.

1. Remove the top cover and keyboard using the disassembly procedures discussed later in this section.
2. Dust or vacuum (with a rubber-tipped nozzle) the inside of the system unit particularly the motherboard surface. Use care to avoid damaging or dislodging any components or cables.
3. Inspect all cables connectors for damage. Ensure that connectors are seated properly before replacing the cover.

## **Protecting the Disk Drives**

To protect the disk drives and data, back up the system disk periodically on diskettes or external backup device. Periodically use a head-cleaning diskette in the disk drive to prolong the life of the drive and to help maintain data integrity.

Here are some maintenance procedures to use when servicing a hard disk:

- Always back up the data files from the hard disk.
  - Run a virus detecting program to check for possible virus infected areas on the hard disk.
  - Use the preinstalled ScanDisk program to correct any errors found in the directory and File Allocation Table (FAT). This will also free up space from any unused sectors.
  - Never turn the computer off when the hard disk is being accessed.
  - Never move or raise the computer while the hard disk is being accessed, most especially don't jar the hard disk as this may cause a hard disk crash.
  - Acquire a hard disk maintenance program like DEFRAG under DOS, or Norton Utilities SPEEDISK programs. These programs reorganize your hard disk by eliminating fragmentation and improves the hard disk access time.
-

## Handling the Battery Packs

The battery packs furnished with the computer require reasonable care and handling to ensure efficient operation and maximum life. Periodically inspect the battery terminals and the batteries for evidence of corrosion and oxide build-up.

To ensure that the battery packs endure normal life cycle, always observe the following precautions when handling the battery packs:

- Do not drop the battery packs or subject them to excessive shock and vibration.
- Do not expose the battery packs to direct sunlight, moisture, or chemical compounds, or extreme heat.
- Do not disassemble the battery packs.
- Do not use the battery packs to power other devices.
- Do not short the battery leads or connect the battery with reversed polarity.
- Never attempt to charge the battery packs in any way other than as described in this manual and the user's guide.
- Always charge the battery packs as soon as possible after a low battery indication.

## Maintaining the LCD Quality

When it comes to screen problems, heat plays a big part. After a good working session, the typical routine is to shut the machine and close the cover. The display surface (no matter what type it is) radiates heat. When you close the cover, you trap the heat against the screen. Make sure to leave the computer's cover open for about ten minutes while the heat disperses, before closing the LCD cover.

## REQUIRED TOOLS AND EQUIPMENT

All NEC Versa corrective maintenance procedures can be performed using the following tools:

- Tweezers
  - Small flat-head screwdriver
  - Small Phillips screwdriver
  - Small Hex-bolt screwdriver
-

## DISASSEMBLY AND REASSEMBLY

This subsection contains step-by-step disassembly procedures for the system. Reassembly is the reverse of disassembly. Each procedure is supported by a simplified disassembly illustration to facilitate removal. The Illustrated Parts Breakdown and parts lists for the system unit are shown later in this subsection.

For complete disassembly of the system unit, follow the disassembly order listed in Table 4-1. To reassemble, follow the table in reverse order.

**Table 4-1 NEC Versa 6060 Disassembly Sequence**

Sequence	Part	See Page
1	Hard Disk Drive	4-5
2	Diskette Drive (installed in VersaBay II)	4-7
3	Main Battery Pack (Li-Ion type)	4-8
4	LCD and Top Cover	4-10
5	Power Button, Keyboard	4-12
6	LCD Status Bar, VersaGlide Assembly, Metal Keyboard Supports	4-14
7	Bridge Battery, CMOS Battery, Buzzer	4-15
8	CPU Board	4-16
9	AMP Board	4-17
10	I/O Board	4-17

When disassembling the system unit, follow these general rules.

- Turn off and disconnect all power and all options, including the AC adapter (if connected) and battery packs (see the procedures that follow).
  - Do not disassemble the system into parts that are smaller than those specified in the procedure.
  - Label all removed connectors. Note where the connector goes and in what position it was installed.
-

## Hard Disk Drive

To disassemble the entire NEC Versa computer, start by removing the hard disk drive as follows.



NEC Versa hard disk drives can be used in other NEC notebook computers such as the NEC Versa 2000 and 4000 Series systems. However, hard disk drives from earlier models can only be used in the VersaBay II. Check the top of the hard drive for a blue dot. If the drive case has the blue dot on it, you can use the drive in either the drive bay or the VersaBay II.

1. Check that the NEC Versa power is off.
2. Turn the NEC Versa upside down with the front of the unit facing you.
3. Remove the drive cover as follows:
  - Locate the drive cover release latch. Push the drive cover release latch up while using some pressure to slide the cover to the left.
  - Lift the cover up and off the system.



**Figure 4-1** Removing the Drive Bay Cover

4. Remove the hard disk drive as follows:

- Using your fingers, press down on the hard disk drive at the end closest to the connector.
- While maintaining pressure, slide the drive towards the front of the system.



**CAUTION** Do not lift the drive out of the system before releasing it from the system connector. Doing so can damage the connectors.

---

- Once the drive is disconnected, lift the drive up and out of the system.

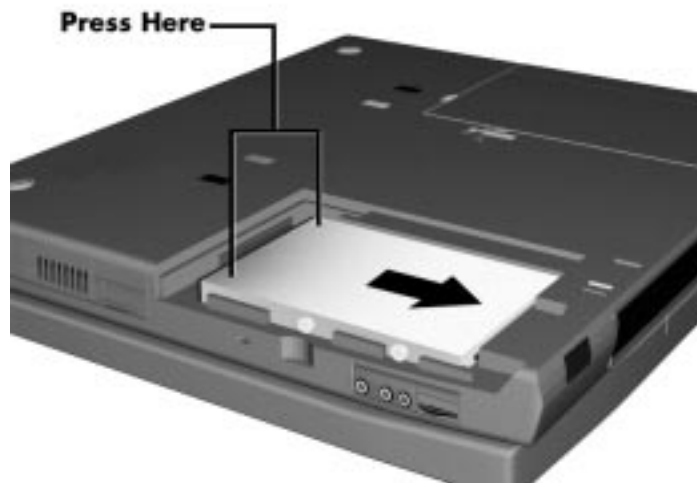

**Figure 4-2** *Removing the Hard Disk Drive*



## Diskette Drive

Remove the diskette drive as follows.

1. Make sure the NEC Versa is powered off, all options are disconnected, and the LCD panel is closed.
2. Turn the system upside down with the front facing you.
3. Locate the VersaBay II release latches on the bottom of the unit.

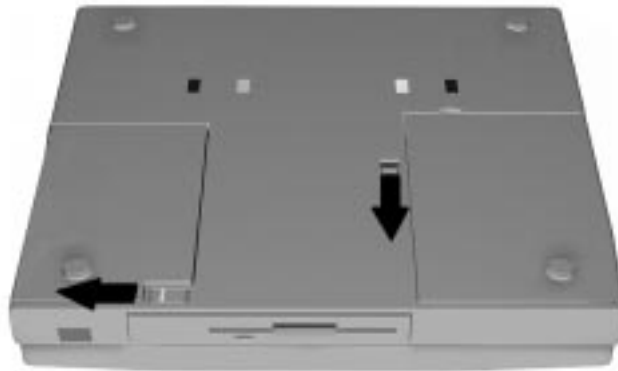

**Figure 4-3 VersaBay II Release Latches**

4. Slide the front latch towards the hard disk drive side of the system, and hold it.
5. Push the middle latch towards you until the diskette drive pops part way out of the unit.
6. Continue to hold the latch near the front of the system to the left, and pull the diskette drive the rest of the way out of the system.



If you release the front latch before completely removing the device, the device casing catches on the inside of the latch.

---



**Figure 4-4** *Removing the Standard Diskette Drive*

### **Main Battery Pack (Li-Ion Type)**

Remove the main battery pack as follows.



Use Li-Ion batteries in the NEC Versa computer for which they are designed. Also, installing another manufacturer's battery, or using a combination of very old and new batteries can deteriorate battery and equipment performance.

---

1. Save your files, exit Windows, and press the Suspend button or turn off system power.
2. Close the LCD and turn the system over, with the front facing you.
3. Release the battery cover latch and slide the battery bay cover away from the system.

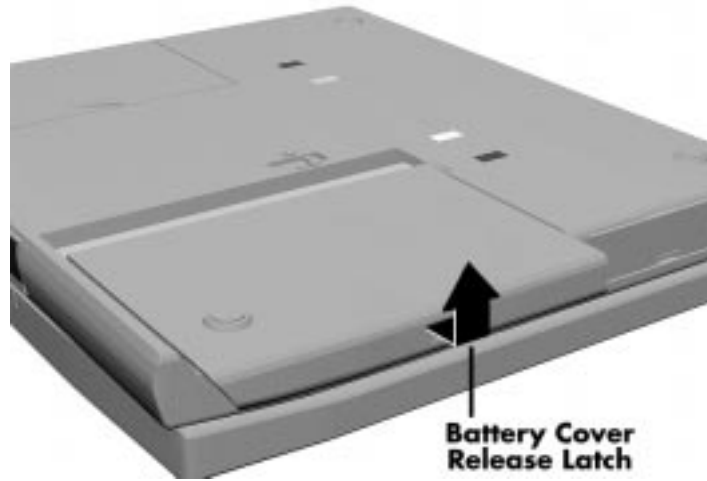

**Figure 4-5** Removing the Battery Compartment Cover

4. Place a finger in the notch on the battery and lift the battery out of the system.

---

**NOTE:** Always lift the battery out of the system by the notch. Failure to do so can damage the battery terminals.

---

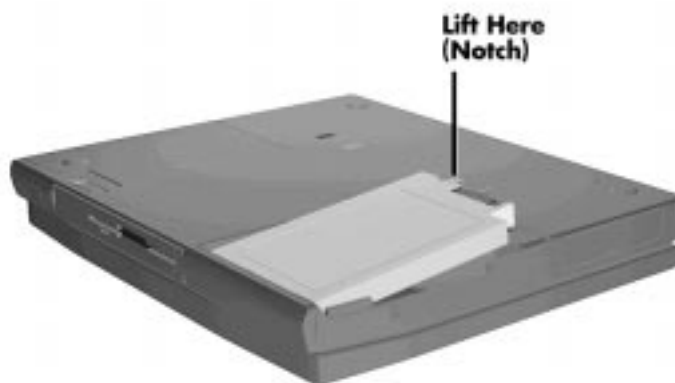

**Figure 4-6** Removing the Battery

---

## LCD and Top Cover

Remove the LCD and top cover as follows.

1. Power off the computer.
2. Remove the bottom base unit cover as follows.
  - Turn the computer over with the VersaBay II slot facing towards you.
  - Locate the 10 screws that secure the bottom base unit cover. In all, there are 2 long-type screws (left side near I/O ports), 2 medium-type screws right side near I/O ports), and 6 short-type screws.

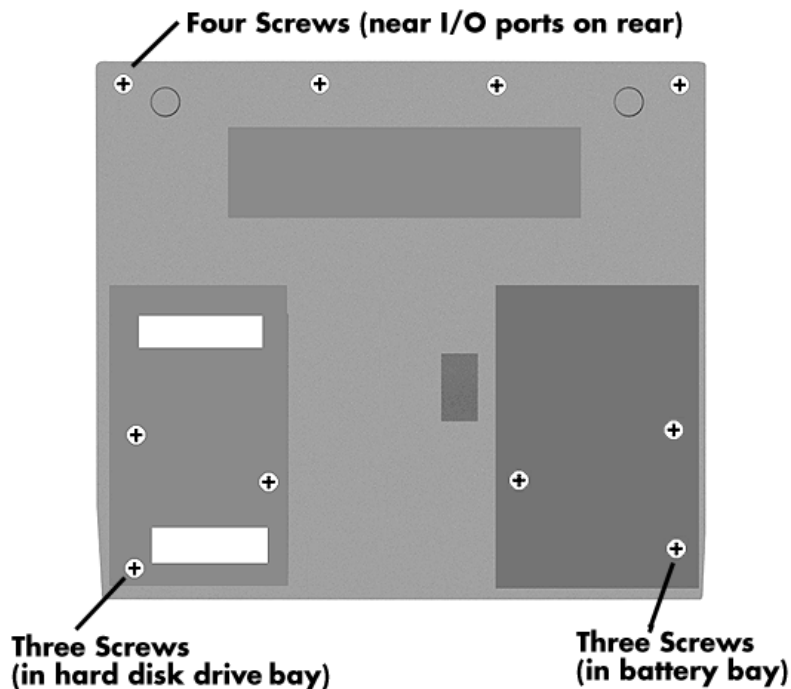

**Figure 4-7** Removing the Bottom Base Screws

- Remove the ten screws.
  - Using a flat-head screwdriver, carefully detach the bottom base unit cover from the top cover.
  - To lift off the top cover, place your left hand in the PC cards slot bay, and pull the left corner of the system upward with your right hand. Be careful not to lift the cover up too far until you have disconnected the LCD cables (see next step.)
-

3. Disconnect the two LCD cables from connectors P4 on the I/O board and the connector on the AMP board.

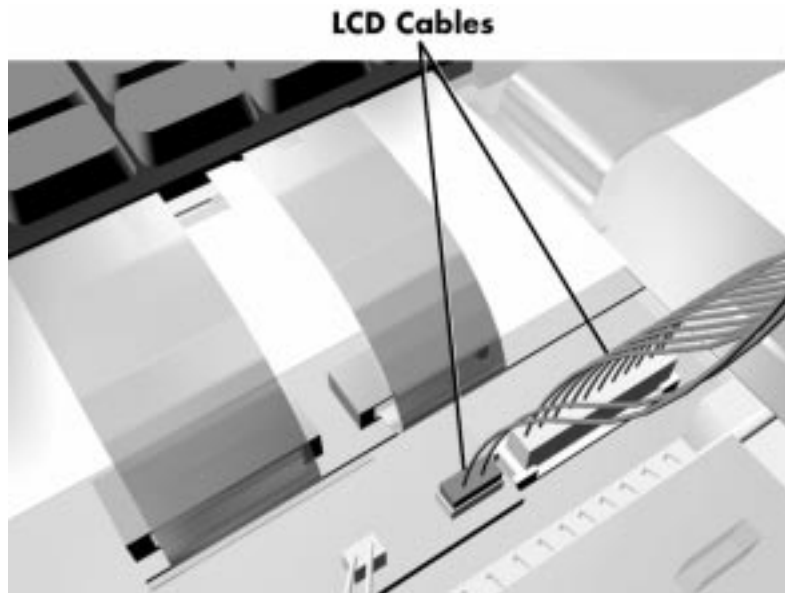

**Figure 4-8** *Disconnecting the LCD Connectors*

4. Lift the top cover and LCD up and off the base unit assembly.



Remove the top cover carefully, so that you don't damage the plastic.

---

## Power Button, Microphone Assembly, Keyboard

Remove the Power button, microphone assembly and/or keyboard as follows.

1. Remove the LCD and top cover as previously described.
2. The Power button is held in place primarily by the computer's top cover. Once the top cover is removed, just lift the Power button out of its retaining inserts.
3. Remove the microphone assembly as follows.
  - Locate the microphone assembly cable that attaches to connector P3 on the audio board. Use a flat-head screwdriver to disconnect the cable from the audio board.
  - Slide the microphone assembly forward and remove from the unit.

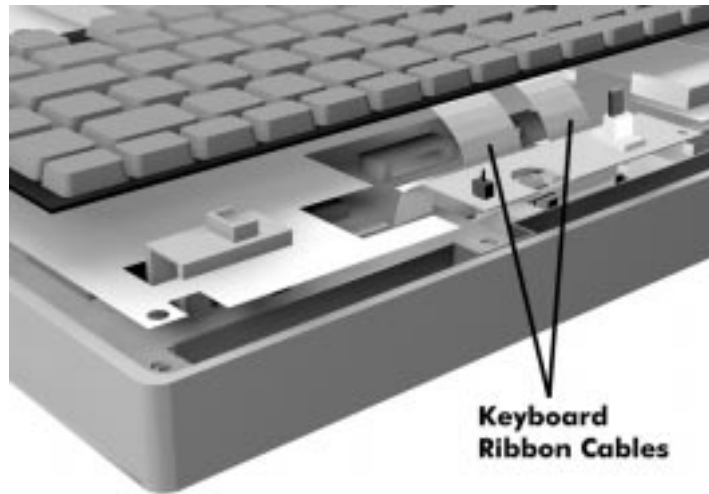

**Figure 4-9** Removing the Power Button, Microphone Assembly, Keyboard

---

4. Remove the keyboard as follows.

- Locate the two ribbon cables that attach to the CPU board via connectors P4 and P5.



**Figure 4-10** *Disconnecting Keyboard Cables*

- Use a flat-head screwdriver to push open the connector tabs.
  - Lift the keyboard out of the base unit.
-

## LCD Status Bar, VersaGlide Assembly, Metal Keyboard Supports

Remove the LCD status bar, VersaGlide, and/or metal keyboard support as follows.

1. Remove the LCD, top cover, keyboard, power button and rear IR assembly as previously described.
2. Remove the LCD status bar as follows.
  - Locate the ribbon cable that attaches to the CPU board via connector P6.
  - Use the tip of a screwdriver and carefully open the connector tabs.
  - Lift up the LCD status bar.

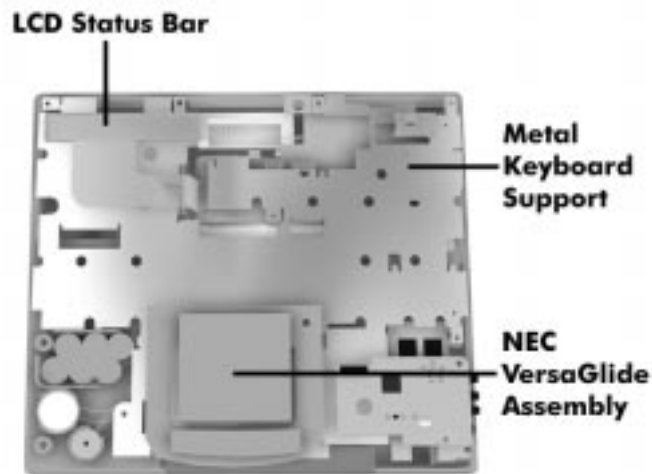

**Figure 4-11** LCD Status Bar, VersaGlide Assembly, Metal Keyboard Supports

3. Remove the VersaGlide assembly as follows.
    - Locate the cable on the VersaGlide assembly.
    - Disconnect the cable from connector P7 on the CPU board.
    - Lift the VersaGlide out of the base unit.
  4. Remove the system audio board as follows:
    - Locate the system audio board. The audio board rests on the top of the metal keyboard supports, right above the IR assembly.
    - Remove the screw and metal bracket. Lift the audio board out of connector P10 on the CPU board.
-



5. First, remove the screw in the metal keyboard support. Then lift the metal keyboard supports from the chassis.

## Bridge Battery, CMOS Battery, Buzzer

Remove the bridge battery, CMOS battery, and/or buzzer (speaker) as follows.

1. Remove the following as previously described:
  - LCD
  - top cover
  - keyboard
  - LCD status bar
  - VersaGlide
2. To remove the bridge battery, disconnect the cable from connector P9 on the I/O board and remove the bridge battery.
3. Remove the CMOS battery as follows.
  - Locate the cable on the CMOS battery.
  - Disconnect the cable from connector P8 on the I/O board and lift the CMOS battery out of the base unit.

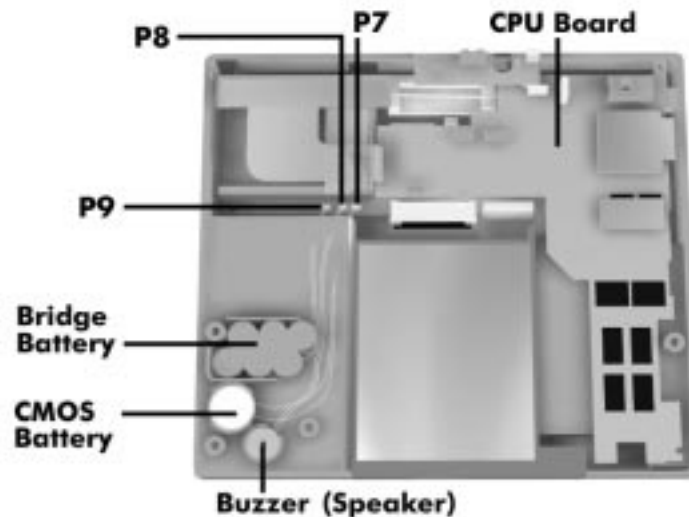

**Figure 4-12** Removing Bridge Battery, CMOS Battery and Buzzer

4. To remove the buzzer, disconnect the buzzer cable from P7 on the I/O board and remove the buzzer.

## CPU Board

Remove the CPU board as follows.

1. Remove the following as previously described:
  - LCD
  - top cover
  - keyboard
  - LCD status bar
  - Audio board
  - VersaGlide
  - metal keyboard supports.
2. Gently lift the CPU board out of connectors P2 and P1 on the I/O board.

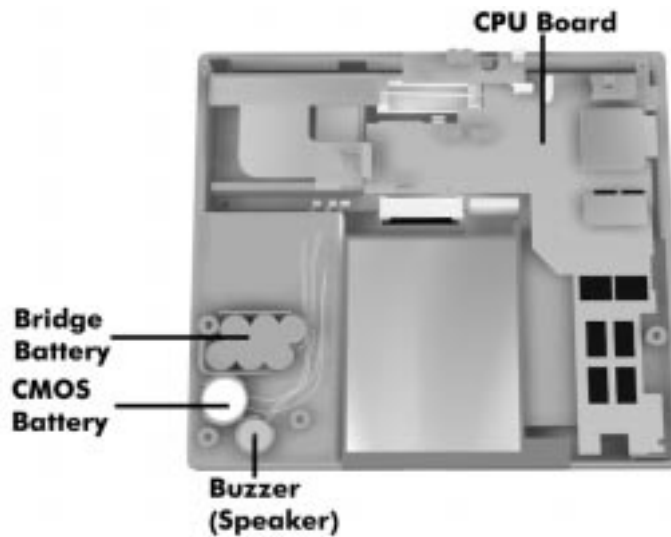

*Figure 4-13 Removing the CPU Board*

---

## AMP Board

Remove AMP board as follows.

1. Remove the following as previously described:
  - LCD
  - top cover
  - keyboard
  - LCD status bar
  - audio board
  - VersaGlide
  - metal keyboard support
  - bridge battery, CMOS battery, buzzer (speaker), and CPU board
2. Remove the screw and support bracket.
3. Gently lift up on the AMP board to disconnect from the I/O board at connectors P15 and P16.

## I/O Board

Remove the I/O board as follows.

1. Remove the following as previously described:
    - LCD
    - top cover
    - keyboard
    - audio board
    - LCD status bar
    - AMP board
    - VersaGlide
    - metal keyboard support
    - CPU board
    - heat shield, AMP board, and the microphone assembly
  2. Remove the PC card shield.
-

3. Remove the screw securing the I/O board to the bottom base unit.
4. Lift the I/O board up and out of the base unit.

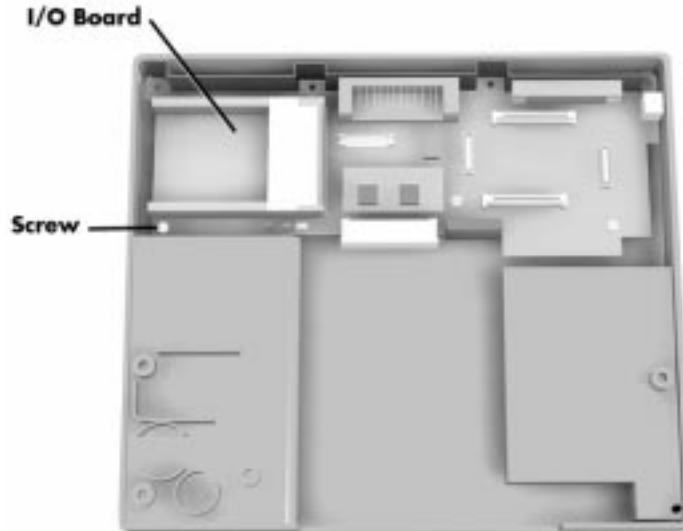
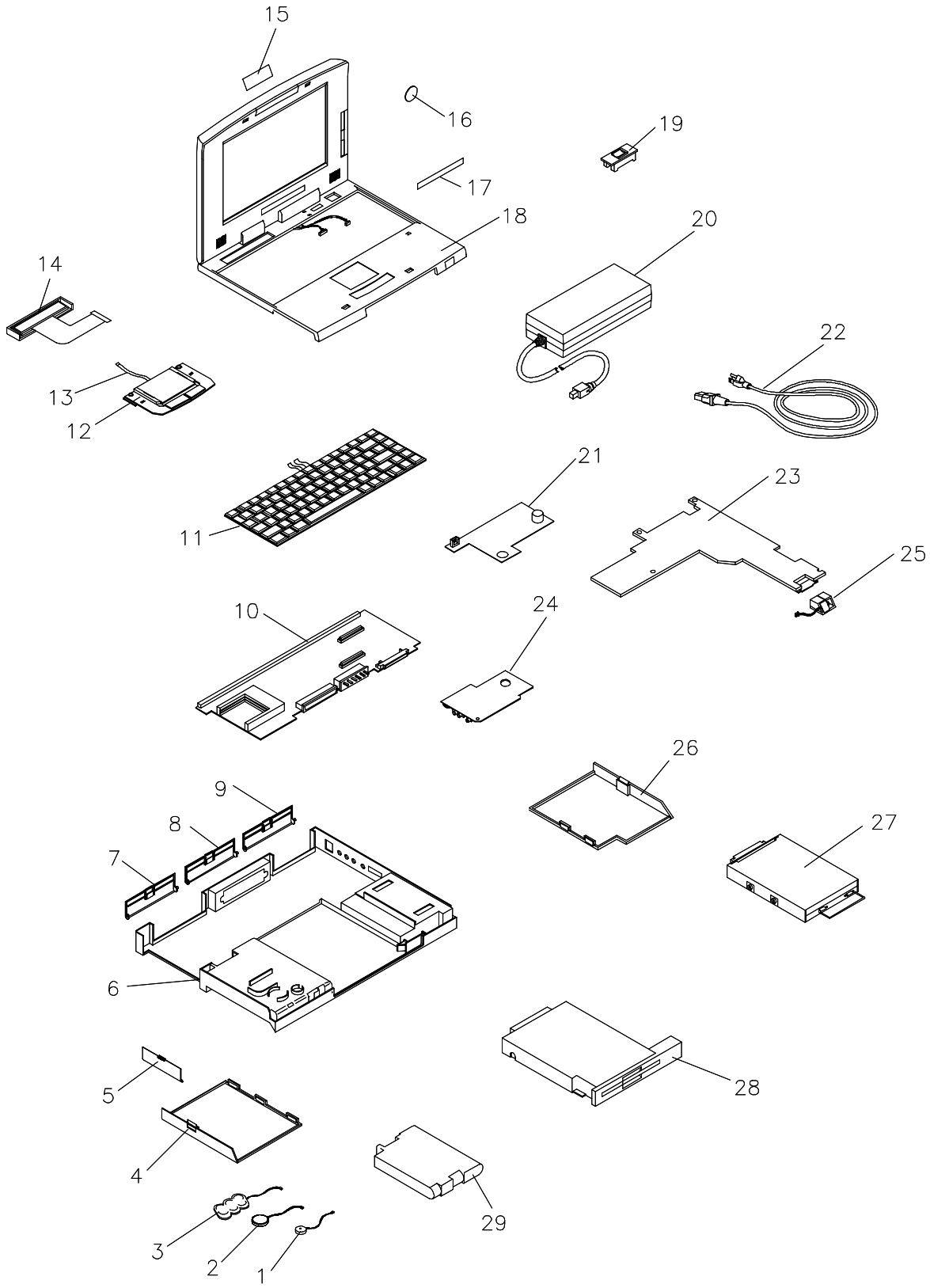

**Figure 4-14** Removing the I/O Board

## **ILLUSTRATED PARTS BREAKDOWN**

The next section contains the NEC part numbers and illustrated parts breakdown (IPB) figure for the NEC Versa. It shows the system exploded view diagram, or IPB. Table 4-2 lists field-replaceable parts and corresponding part numbers.

Review the entire exploded diagram to see how each part is connected or assembled. Try to sub-divide the entire diagram paying particular attention to the LCD Assembly, Top Unit Cover Assembly, and the Base Unit Assembly.



**Figure 4-15 NEC Versa 6060 Illustrated Parts Breakdown**

**Table 4-2 NEC Versa 6060 Field-Replaceable Parts**

<b>Item</b>	<b>Part Number</b>
1. Speaker with Cable (also called Buzzer)	802-870018-007A
2. CMOS Battery	804-021107-005A
3. Bridge Battery	804-021205-002A
4. Battery Compartment Cover (Cap)	136-238578-001A
5. PC Card Slot Cover (Cap)	136-241866-001A
6. Bottom Base Assembly (Plastic)	136-241862-001A
7. Assembly Cap I/F (Serial/VGA Ports)	136-238586-001A
8. Assembly Cap, Docking Station	136-238587-001A
9. Assembly Cap I/F (PS/2/Parallel Port)	136-238589-001A
10. I/O Board, G8YJP, (SVGA model, G8WKPA)	158-057405-000
11. U.S. Keyboard	808-897250-001A
12. Glide Point Logitech TP2	808-897316-001A
13. VersaGlide Cable	808-742261-001A
14. LCD Status Bar	158-057234-000
15. Logo, NEC	136-600325-A
16. Intel Inside Sticker	158-032237-000
17. NEC Versa 6060	
18. LCD Top Cover Assembly (SVGA 12.1")	158-057403-000
19. Power Button	136-620570-001A
20. AC Adapter (ADP 74)	808-891864-001A
21. Sound Board	158-057406-000
22. AC Power Cable (U.S.)	808-741299-001A
23. CPU Board	158-057408-000
24. Audio Board	158-057407-000
25. Microphone	808-876316-000
26. Hard Disk Compartment Cover	136-238579-001A
27. 2.1 GB Hard Disk Drive	OP-220-62008
28. 3.5-inch, 1.44-MB Diskette Drive	134-507049-0010
29. Main Battery (Li-Ion)	804-021248-001A
30. 20X CD-ROM Reader*	136-242043-001A

<b>Item</b>	<b>Part Number</b>
31. CD ROM Carry Case*	158-032107-000
32. Shipping Carton*	
33. Left Packaging Foam Cushion*	158-041007-000
34. Right Packaging Foam Cushion*	158-041007-001
35. <i>NEC Versa 6060 Quick Reference Card*</i>	819-200277-000 Rev. 00
39. <i>NEC Versa 60600 Quick Setup Sheet*</i> <i>Windows 95</i>  <i>Windows NT</i>  <i>Windows for Workgroups</i>	819-200276-000 Rev. 00 819-200300-000 Rev. 00 819-200301-000 Rev. 00
40. <i>NEC Versa 6060 User's Guide*</i>	819-200275-000 Rev. 00
41. <i>NEC Versa 6060 Service and Reference Manual</i>	819-200278-000 Rev. 00

\* Not Shown in IPB Figure

This data was prepared September, 1997. For an up-to-date listing of spare parts, please call FaxFlash (888) 329-0088 (international (978) 635-6090) and order document number 42200278.

## SERVICE INFORMATION

NEC service and information telephone numbers are listed in Table 4-3.

**Table 4-3 NEC Service and Information Telephone Numbers**

Service	Call
To order NECCSD spare parts	In the U.S., call 1(800) 632-4525
To order options in the U.S.	Local Sales Office
To access the NECCSD Electronic Bulletin Board System (BBS)	1(978) 635-4706
To download files - provides software drivers and the latest ROM BIOS	1(978) 635-4706
NECCSD Customer Service and Technical Support Center	In the U.S., call 1-800-632-4525
Listen to the automated attendant and select the appropriate menu to reach one of the following departments:  Information Center — literature, dealer locations, sales leads, response to ads  NSRC (National Service Response Center) — questions other than products, spare parts or technical support  Service Contracts	
NEC FaxFlash <sup>SM</sup> Service — automated service that sends the latest information about NEC products to the fax machine 24 hours a day	In the U.S. and Canada, call 1(888) 329-0088  Outside U.S., 1(978) 635-6090

## TECHNICAL SUPPORT

NECCSD Customer Service Response Center provides an E-mail service for Internet users. Technical questions regarding NEC products can be sent over the Internet system to the Center. The Internet address is as follows:

**tech-support@neccsd.com**

If it is more convenient, questions may also be faxed to the Customer Service Response Center. The fax number is:

**(978) 635-4666**

Along with the complete product name and question(s), be sure to include your name and fax number or Internet address, so that an expert can respond to the question.

---



It would also help to include your telephone number in case the Customer Service Response Center can not get their answer to you. We will reply to all questions received by Internet or fax within one business day.

## **PRODUCT INFORMATION**

NEC FaxFlash is an automated electronic information service used to obtain up-to-date product application notes, installation procedures, troubleshooting tips, data sheets, technical information bulletins, price lists, and other information.

Information can be obtained from the FaxFlash service 24 hours a day, 7 days a week. Using a touch-tone telephone, call the FaxFlash number, order the desired information through the automated attendant, and FaxFlash will automatically fax the information.

Catalogs that list the documents and the document numbers are available. Current catalogs include:

- Catalog 1 – Telephone Directory and information about Online Services
  - Catalog 3 – Product specifications, warranty policy, UltraCare guidelines, and sales information
  - Catalog 5 – Pro Serva and Express Server System technical support information
  - Catalog 6 – NEC Ready System technical support information
  - Catalog 7 – Powermate Systems technical support information
  - Catalog 8 – NEC Portable System (including Versa Notebooks and MobilePro Handheld Personal computers) technical support information
-

## ORDERING INFORMATION FROM FAXFLASH

Order information from FaxFlash as follows:

1. Check that the fax machine is on.
2. Locate the document part number.
3. Using a touch-tone telephone, call 1-888-329-0088 (U.S. and Canada only).

For international use, enter the international long distance access number, the U.S. telephone number, and the U.S. extension (1-978-635-6090).

4. Listen to the instructions provided by the automated attendant.

Press **1** to skip the FaxFlash introduction and jump to the automated instructions for ordering a document or catalog.

Press **2** for an introduction to FaxFlash, followed by the automated instructions for ordering a document or catalog.

5. When asked by the automated attendant, enter your fax number and telephone number.

For international use, first enter the international long distance access number (011), your country code, area code or city code, then your fax number.

The information requested will be sent automatically to your fax machine. If FaxFlash attempts to send the second order before the first order is completed, the order could be canceled. After three tries, FaxFlash assumes that the line is busy.

---

## Appendix A

---

# Connector Locations and Pin Assignments

Figure A-1 and Table A-1 show CPU board connectors. The remaining tables provide pin assignments for additional system connectors.

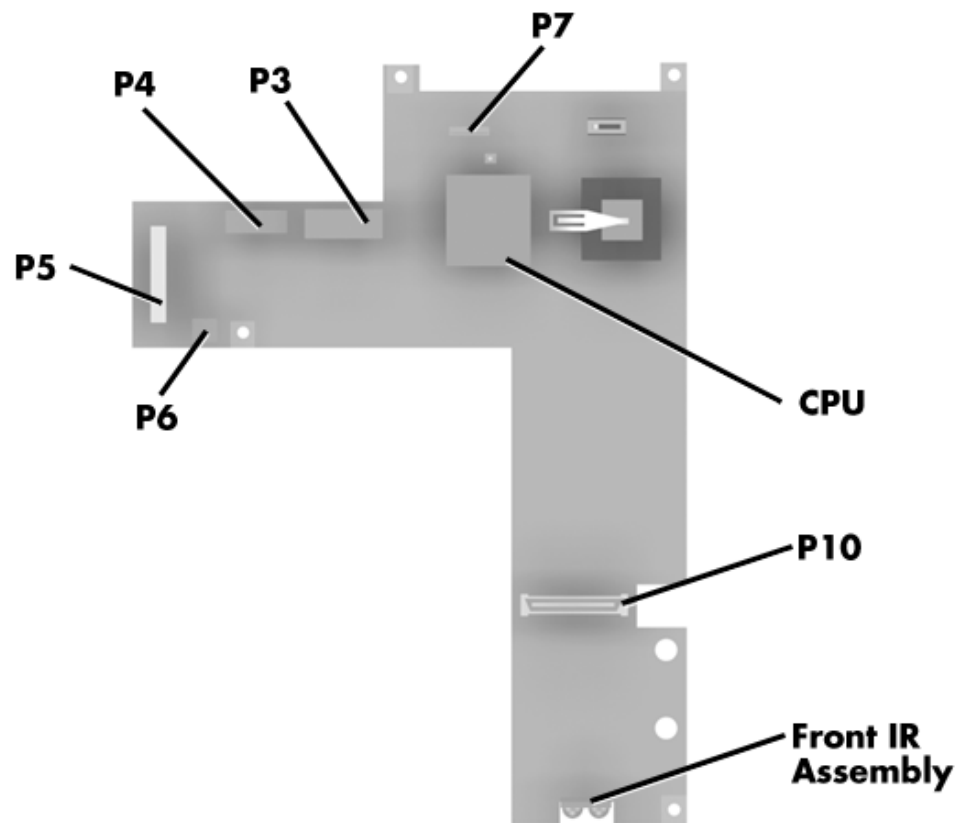
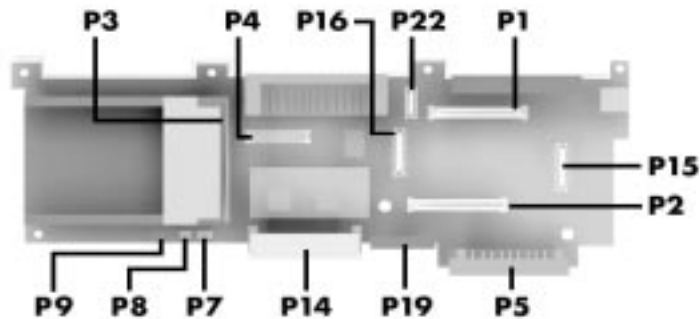

*Figure A-1 CPU Board Layout*

---

**Table A-1 CPU Board Connectors**

Connector	Description
P4 and P5	Keyboard Connectors
P6	LCD Status Bar
P7	VersaGlide Assembly Connector
P8 and P9	Rear Infrared Assembly Connector
P11	Memory Card Connector



**Figure A-2 I/O Board Layout**

**Table A-2 I/O Board Connectors**

Connector	Description
P1 and P2	CPU Board Connectors
P3	PC Card Connector
P4	LCD Connector
P5	HDD Connectors
P7	Buzzer Connector
P8	CMOS Battery Connector
P9	Bridge Battery Connector
P14	VersaBay Connector
P15 and P16	AMP Board Connectors
P19	VersaBay Battery Connector
P22	Main Sound Board/Sub Bridge

---

**Table A-3 Keyboard/Mouse Connectors**

<b>Pin</b>	<b>Signal</b>
1	Keyboard Data
2	Mouse Data
3	Ground
4	+5V
5	Keyboard Clock
6	Mouse Clock

**Table A-4 Serial Port Connector Pin Assignments**

<b>Pin</b>	<b>Signal</b>
1	Data Carrier
2	Receive Data
3	Transmit Data
4	Data Terminal Ready
5	Ground
6	Data Set Ready
7	Request to Send
8	Clear to Send
9	Ring Indicator

---

**Table A-5 CRT Connector Pin Assignments**

<b>Pin</b>	<b>Signal</b>
1	Red
2	Green
3	Blue
4	OPT1
5	Ground
6	Ground
7	Ground
8	Ground
9	+5V PnP VESA Vcc
10	Ground
11	OPT2
12	PnP VESA Data
13	Horizontal Sync
14	Vertical Sync
15	PnP VESA Clock

**Table A-6 Parallel Printer Pin Assignments**

<b>Pin</b>	<b>Signal</b>
1	- Strobe
2	Data Bit 0
3	Data Bit 1
4	Data Bit 2
5	Data Bit 3
6	Data Bit 4
7	Data Bit 5
8	Data Bit 6
9	Data Bit 7
10	- Acknowledge
11	Busy
12	PE

---

**Table A-6 Parallel Printer Pin Assignments**

Pin	Signal
13	Select
14	- Auto Feed XT
15	- Error
16	- Initialize
17	- Select In
18 -25	Ground

**Table A-7 Power Connector**

Pin	Signal
1	Ground
2	DCSYS
3	DCCHG
4	Type

**Table A-8 Hard Disk Drive Connector**

Pin	Signal
1	HDD Access LED
2	+5V
3	Chip Select 0
4	+5
5	Chip Select 1
6	+5V
7	Address 0
8	+5V
9	Address 2
10	+5V
11	Address 1
12	+5V
13	Diagnostic
14	Not Used

---

**Table A-8 Hard Disk Drive Connector**

<b>Pin</b>	<b>Signal</b>
15	IRQ
16	DMACK
17	Not Used
18	IO Channel Ready
19	MS Select
20	IO Write
21	I/O Read
22	DMA Request
23	Data 0
24	Data1
25	Data15
26	Data14
27	Data2
28	Data13
29	Data3
30	Not Used
31	Data12
32	Ground
33	Data4
34	Ground
35	Data4
36	Ground
37	Data5
38	Ground
39	Data10
40	Ground
41	Data6
42	Ground
43	Data9
44	Ground
45	Data7
46	Ground

---



**Table A-8 Hard Disk Drive Connector**

<b>Pin</b>	<b>Signal</b>
47	Ground
48	Ground
49	RESET
50	Ground

## Appendix B

---

# Video Modes

The following tables list NEC Versa system video modes.

**Table B-1 LCD Display Mode Setting (800x600 TFT Color LCD and Simultaneous CRT Display)**

Mode (Hex)	Display Mode	Colors	Text Display	Pixel Resolution	Font	Video Memory (KB)
0*	Text	16 (gray)	40x25	320x200	8x8	256
0**	Text	16 (gray)	40x25	320x350	8x14	256
0***	Text	16	40x25	360x400	9x16	256
1*	Text	16	40x25	320x200	8x8	256
1**	Text	16	40x25	320x350	8x14	256
1***	Text	16	40x25	360x400	9x16	256
2*	Text	16 (gray)	80x25	640x200	8x8	256
2**	Text	16 (gray)	80x25	640x350	8x14	256
2***	Text	16	80x25	720x400	9x16	256
3*	Text	16	80x25	640x200	8x8	256
3**	Text	16	80x25	640x350	8x14	256
3***	Text	16	80x25	720x400	9x16	256
4	Graphics	4	40x25	320x200	8x8	256
5*	Graphics	4 (gray)	40x25	320x200	8x8	256
5**	Graphics	4 (gray)	40x25	320x200	8x8	256
5***	Graphics	4	40x25	320x200	8x8	256
6	Graphics	2	80x25	640x200	8x8	256

\*CGA  
\*\*EGA  
\*\*\*VGA

---

**Table B-1 LCD Display Mode Setting (800x600 TFT Color LCD and Simultaneous CRT Display) (cont'd)**

Mode (Hex)	Display Mode	Colors	Text Display	Pixel Resolution	Font	Video Memory (KB)
7*	Text	Mono	80x25	720x350	9x14	256
7**	Text	Mono	80x25	720x350	9x14	256
7***	Text	Mono	80x25	720x400	9x16	256
D**/***	Graphics	16	40x25	320x200	8x8	256
E**/***	Graphics	16	80x25	640x200	8x8	256
F**/***	Graphics	Mono	80x25	640x350	8x14	256
10**/***	Graphics	16	80x25	640x350	8x14	256
11***	Graphics	2	80x30	640x480	8x16	256
12***	Graphics	16	80x30	640x480	8x16	256
13***	Graphics	256	40x25	320x200	8x8	256

\* MDA  
 \*\* EGA  
 \*\*\* VGA

**Table B-2 LCD Display Extended Video Mode**

Mode	Mode Type	Memory Org	Pixel Resolution	Color	Display Fonts	Font Size	Video Memory (KB)
100	Graph	Pack Pix	640x400	256	80x25	8x16	256
101	Graph	Pack Pix	640x480	256	80x30	8x16	512
102	Graph	Planar	800x600	16	100x37	8x16	256
103	Graph	Pack Pix	800x600	256	100x37	8x16	512
10D	Graph	Pack Pix	320x200	32K	40x25	8x8	256
10E	Graph	Pack Pix	320x200	64K	40x25	8x8	256
110	Graph	Pack Pix	640x480	32K	80x30	8x16	1024
111	Graph	Pack Pix	640x480	64K	80x30	8x16	1024
112	Graph	Pack Pix	640x480	16M	80x30	8x16	1024
113	Graph	Pack Pix	800x600	32K	100x37	8x16	1024
114	Graph	Pack Pix	800x600	64K	100x37	8x16	1024
115	Graph	Pack Pix	800x600	16M	100x37	8x16	1536

\*200, 400 and 480 line modes are converted to 600 lines by the BIOS. Furthermore, 200 line mode is converted to 400 line mode with the double scanned.

**Table B-3 CRT Display Mode (CRT only)**

<b>Mode (Hex)</b>	<b>Display Mode</b>	<b>Colors</b>	<b>Text Display</b>	<b>Pixel Resolution</b>	<b>Font</b>	<b>Refresh Rate</b>
0, 1	Text	16	40x25	320x200	8x8	70
0*, 1*	Text	16	40x25	320x200	8x14	70
0**, 1**	Text	16	40x25	360x400	9x16	70
2, 3	Text	16	80x25	640x200	8x8	70
2*, 3*	Text	16	80x25	640x350	8x14	70
2**, 3**	Text	16	80x25	720x400	9x16	70
4,5*	Graphics	4	40x25	320x200	8x8	70
6	Graphics	2	80x25	640x200	8x8	70
7*	Text	Mono	80x25	720x350	9x14	70
7**	Text	Mono	80x25	720x400	9x16	70
D	Planar	16	40x25	320x200	8x8	70
E	Planar	16	80x25	640x200	8x8	70
F	Planar	Mono	80x25	640x350	8x14	70
10	Planar	16	80x25	640x350	8x14	70
11	Planar	2	80x30	640x480	8x16	60
12	Planar	16	80x30	640x480	8x16	60
13	Packed Pixel	256	40x25	320x200	8x8	70

\*EGA Extension

\*\*VGA Extension

**Table B-4 CRT Display Extended Video Mode**

Mode	Mode Type	Memory Org	Pixel Resolution	Color	Display fonts	Font Size	Dot Colock (MHz)	Horiz. Freq (MHz)	Vert. Freq. (Hz)	Video Memory (KB)
101	Graph	Pack Pix	640x480	256	80x30	8x16	25.175 31.5 36	31.5 37.5 43.3	60 75 85	512
103	Graph	Pack Pix	800x600	256	100x37	8x16	40 49.5 56.25	37.8 46.9 53.7	60 75 85	512
105	Graph	Pack Pix	1024x768	256	128x48	8x16	65 78.75	48.3 60	60 75 85	1024
111	Graph	Pack Pix	640x480	64K	80x30	8x16	25.175 31.5 36	31.5 37.5 43.3	60 75 85	1024
112	Graph	Pack Pix	640x480	16M	80x30	8x16	25.175 31.5 36	31.5 37.5 43.3	60 75 85	1024
114	Graph	Pack Pix	800x600	64K	100x37	8x16	40 49.5 56.25	37.8 46.9 53.7	60 75 85	1024
115	Graph	Pack Pix	800x600	16M	100x37	8x16	40 49.5 56.25	37.9 46.9 53.7	60 75 85	1536
117	Graph	Pack Pix	1024x768	64K	128x48	8x16	65 78.75	48.3 60	60 75	1536

**Table B-5 Panning Video Mode (800x600 TFT Color LCD and Simultaneous CRT Display)**

Mode	Display Mode	Memory Org	Pixel Resolution	Colors	Text Display	Font Size	Video Memory (KB)
<b>105</b>	Graph	Pack Pix	800x600 (1024x768)	256	100x37 (160x64)	8x16	1024
<b>116</b>	Graph	Pack Pix	800x600 (1024x768)	32K	100x37 (128x48)	8x16	1536
<b>117</b>	Graph	Pack Pix	800x600 (1024x768)	64K	100x37 (128x48)	8x16	1536

---

# Index

- AC adapter, 2-4
  - Accessing setup, 2-20
  - Active mode, 1-22
  - Automatic power saving, 2-31
  - Automatic power saving features, 1-21
  - Backup system disk, 4-2
  - Battery
    - determining status, 2-5
    - handling, 2-6
    - leakage, 2-10
    - recharging precautions, 2-10
    - when to change, 2-6
  - Battery bay release latch, 1-10
  - Battery pack, 1-11
    - precautions, 2-10
  - Battery warning, 2-7
  - BIOS update, 1-18
  - Bridge battery, 1-14
  - Cable connections, 2-3
  - Cache RAM, 1-14
  - CD-ROM reader, 1-12
  - Chip types, 1-16
  - Cleaning
    - internal components, 4-2
    - outer surface, 4-1
  - CMOS battery, 1-14
  - CPU, 1-17
  - CPU board, 1-12
  - CPU board connectors, A-1
  - Creative Vibra 16S VLSI chip, 1-19
  - CRT connector pin assignments, A-4
  - DC car adapter, 2-11
  - Default power management settings, 1-23
  - Disassembly guidelines, 4-4
  - Diskette controller, serial interface,
    - parallel interface, 1-18
  - Diskette drive, 1-7, 1-12
  - Display, 1-25
  - Expansion port, 1-11
  - Field-replaceable parts list, 4-18
  - Flash ROM, 1-17
  - Front IR assembly, 1-7
  - Function keys, 2-14
  - Handling battery packs, 4-3
  - Hard disk drive, 1-11, 1-12
    - specifications, 1-11
  - Hard disk drive bay, 1-8
  - Hardware failures, 2-18
  - Hardware Overview
    - VersaBay II, 1-7
  - Headphones, 1-8
  - I/O connector descriptions, 2-3
  - Increasing system memory, 1-14
  - Interrupt level assignments, 1-20
  - Kensington lock, 1-8
  - Keyboard, 1-6, 1-26
  - Keyboard controller, 1-18
  - Keyboard panel controls, 2-12
  - Keyboard port, 1-10
  - Keyboard/mouse connectors, A-3
  - LCD features, 1-2
  - Line-In, 1-8
  - Local power management, 1-22
  - Low battery power, 1-11, 2-5
  - Maintaining LCD quality, 4-3
  - Maintenance, 4-1
  - Memory
    - cache RAM, 1-14
  - Memory map, 1-14
  - Microprocessor, 1-17
  - Mobile Triton chipset, 1-17
  - Model configurations, 1-1
  - Monitor port, 1-11
  - Mouse port, 1-10
  - NEC Versa disassembly sequence, 4-4
  - NEC Versa video modes, B-1
  - Operating controls, 2-12
  - Optional battery charger, 2-6
  - Options catalog, 2-6
  - Ordering information from FaxFacts,
    - 4-23
  - Parallel interface enhanced capabilities
    - port, 1-15
  - Parallel port, 1-10
-

- Parallel port pin assignments, A-5
  - PC card slots, 1-9
  - Plug and play, 1-23
  - Post error messages, 2-18
  - Post errors, 2-18
  - Power button, 1-3
  - Power connector pin assignments, A-5
  - Power LED indicator, 1-4
  - Power management modes, 1-5
    - active, 1-22
    - local standby, 1-22
    - suspend, 1-22
  - Power management overview, 1-21
  - Power management settings
    - default, 1-23
  - Power management under AC, 2-28
  - Power sources, 2-4
  - Power switch, 2-12
  - PowerGauge utility, 2-5
  - Power-on self test (POST), 2-17
  - Product information, 4-23
  - Quick troubleshooting, 3-1
  - Recharging the battery, 2-6
  - Replacing the battery pack, 2-7
  - ROM BIOS, 1-17
  - Serial interface, 1-16
  - Serial port, 1-11
  - Serial port connector pin assignments, A-3
  - Service telephone numbers, 4-22
  - Servicing a hard disk, 4-2
  - Servicing the system
    - required tools, 4-3
  - Setting power management levels
    - using F7, 1-21
  - Setting system parameters, 2-23
    - hard disk drive, 2-27
    - peripherals, 2-29
    - power savings, 2-27
  - Setting time and date, 2-26
  - Setup key functions, 2-23
  - Setup utility, 2-20
    - main screen, 2-26
  - Side panel controls, 2-12
  - Smart power switch, 2-14
  - Sound board, 1-13
  - Standby mode, 1-22
  - Status bar, 1-4, 2-13
  - Status icons, 1-5
  - Switch settings, 2-15
  - System date, 2-26
  - System disassembly
    - audio board, 4-17
    - bridge battery, 4-15
    - buzzer, 4-15
    - CMOS battery, 4-15
    - CPU board, 4-16
    - diskette drive, 4-7
    - hard disk drive, 4-5
    - heat shield, 4-17
    - I/O board, 4-17
    - IR board, 4-12
    - keyboard, 4-12
    - LCD and top cover, 4-10
    - main battery pack, 4-8
    - metal keyboard support, 4-14
    - microphone, 4-16
    - power button, 4-12
    - status bar, 4-14
    - VersaGlide, 4-14
  - System icons, 2-13
  - System parameters, 2-18
  - System setup, 2-1
  - System specifications, 1-24
  - System status
    - icons, 2-13
  - System time, 2-26
  - System video, 1-15
  - Technical support, 4-22
  - Troubleshooting
    - helpful questions, 3-4
  - Unpacking, 2-1
  - Updating the BIOS, 2-15, 2-17
  - Using the battery pack, 2-5
  - Using the setup utility
    - time/date, 2-26
  - VersaBay II, 1-7
  - VersaGlide, 1-6
  - VGA controller, 1-18
  - Video mode
    - CRT only, 1-15
  - Video RAM, 1-15
-

Volume control, 1-8, 1-9

Y-cable adapter, 1-10

---



## BATTERY REPLACEMENT

A lithium CMOS clock battery in your computer maintains system configuration information. In the event that the battery fails to maintain system configuration information, NEC recommends that you replace the battery. Have an authorized NEC service representative replace the battery.

### **WARNING**

There is a danger of explosion if the battery is incorrectly replaced. Replace only with the same or equivalent type recommended by the manufacturer. Discard used batteries according to the manufacturer's instructions.

### **ATTENTION**

Il y a danger d'explosion s'il y a remplacement incorrect de la batterie. Remplacer uniquement avec une batterie du même type ou d'un type recommandé par le constructeur. Mettre au rebut les batteries usagées conformément aux instructions du fabricant.

## BATTERY DISPOSAL

The bridge battery is made of nickel metal hydride (NiMH). The main battery and CMOS battery are made of lithium-ion (Li-Ion).

Contact your local waste management officials for other information regarding the environmentally sound collection, recycling, and disposal of the batteries. For additional information on the proper collection or disposal of rechargeable batteries, please call 1-800-8-BATTERY.

(For United States Use Only)

**FEDERAL COMMUNICATIONS COMMISSION  
RADIO FREQUENCY INTERFERENCE STATEMENT**

 **WARNING**

Changes or modifications to this unit not expressly approved by the party responsible for compliance could void the user's authority to operate the equipment.



This is a Class B Digital Device. This equipment has been tested and found to comply with the limits for a Class B digital device, pursuant to Part 15 of the FCC Rules. These limits are designed to provide reasonable protection against harmful interference in a residential installation. This equipment generates, uses and can radiate radio frequency energy and, if not installed and used in accordance with the instructions, may cause harmful interference to radio communications.

However, there is no guarantee that interference will not occur in a particular installation. If this equipment does cause harmful interference to radio or television reception, which can be determined by turning the equipment off and on, the user is encouraged to try to correct the interference by one or more of the following measures.

- Reorient or relocate the receiving antenna.
- Increase the separation between the equipment and receiver.
- Connect the equipment to an outlet on a circuit different from the one to which the receiver is connected.

To meet FCC standards, shielded cables and power cords are required to connect this device to a personal computer or other Class B certified device.

---

***Canadian Department of Communications Compliance Statement***

This equipment does not exceed the Class B limits for radio noise emissions from digital apparatus set out in the Radio Interference Regulations of the Canadian Department of Communications.

***Avis de conformité aux normes du ministère des Communications du Canada***

Cet appareil respecte les limites de bruits radioélectriques applicables aux appareils numériques de Classe B prescrites dans le Règlement sur le brouillage radioélectrique édicté par le ministère des Communications du Canada.

***European Community Directive Conformance Statement***

This product is in conformity with the protection requirements of EC Council Directive 89/336/EEC on the approximation of laws of the Member States relating to electro-magnetic compatibility. This product satisfied the Class B limits of EN 55022.

NEC Computer Systems Division, Packard Bell NEC, Inc.  
1414 Massachusetts Avenue  
Boxborough, Massachusetts 01719  
1-800-632-4525