

PROPRIETARY NOTICE AND LIABILITY DISCLAIMER

The information disclosed in this document, including all designs and related materials, is the valuable property of NEC Computer Systems Division, Packard Bell NEC, Inc. (NECCSD, PBNEC) and/or its licensors. NECCSD and/or its licensors, as appropriate, reserve all patent, copyright and other proprietary rights to this document, including all design, manufacturing, reproduction, use, and sales rights thereto, except to the extent said rights are expressly granted to others.

The NECCSD product(s) discussed in this document are warranted in accordance with the terms of the Warranty Statement accompanying each product. However, actual performance of each such product is dependent upon factors such as system configuration, customer data, and operator control. Since implementation by customers of each product may vary, the suitability of specific product configurations and applications must be determined by the customer and is not warranted by NECCSD.

To allow for design and specification improvements, the information in this document is subject to change at any time, without notice. Reproduction of this document or portions thereof without prior written approval of NECCSD is prohibited.

NEC is a registered trademark, Versa is a U.S. registered trademark, MiniDock, VersaBay, VersaGlide, and PortBar are trademarks, and UltraCare is a U.S. registered service mark of NEC Corporation, used under license.

FaxFlash is a service mark of NEC Computer Systems Division (NECCSD), Packard Bell NEC, Inc.

All other product, brand, or trade names used in this publication are the property of their respective owners.

First Printing — October 1997

Copyright 1997
NEC Computer Systems Division, Packard Bell NEC, Inc.
1414 Massachusetts Avenue
Boxborough, MA 01719
All Rights Reserved

Preface

This service and reference manual contains the technical information necessary to set up and maintain the NEC Versa[®] 5060 and 5060X notebook computer.

The manual also provides hardware and interface information for users who need an overview of the system design. The manual is written for NEC-trained customer engineers, system analysts, service center personnel, and dealers.

The manual is organized as follows:

Section 1 — Technical Information, provides an overview of the hardware and interface components. System specifications are listed including computer dimensions, weight, environment, safety compliance, power consumption, and system memory specifications.

Section 2 — Setup and Operation, takes the authorized service technician or dealer from unpacking to setup and operation. The section includes a description of operating controls, setting parameters and accessing the NECCSD bulletin board system (BBS).

Section 3 — Troubleshooting, lists troubleshooting procedures as well as helpful servicing hints.

Section 4 — Field Service Guidelines, provides disassembly and assembly procedures, and an exploded-view diagram of the NEC Versa system with part numbers.

Appendix A — Connector Locations and Pin Assignments, provides a list of the main board internal connector pin assignments and a list of external pin assignments.

Appendix B — Video Modes, lists NEC Versa supported video modes.

An **Index** is included for convenience.

Abbreviations

A	ampere	DC	direct current
AC	alternating current	DIMM	dual-inline memory module
ACPI	advanced control power interface	DIP	dual in-line package
APM	advanced power management	DLAB	Divisor Latch Address bit
AT	advanced technology (IBM PC)	DMA	direct memory access
BBS	Bulletin Board System	DMAC	DMA controller
BCD	binary-coded decimal	DOS	disk operating system
BCU	BIOS Customized Utility	DRAM	dynamic RAM
BIOS	basic input/output system	DTE	data terminal equipment
bit	binary digit	ECC	error checking and correction
bpi	bits per inch	ECP	extended capabilities port
bps	bits per second	EDO	enhanced data out
BUD	BIOS Upgrade Diskette	EDS	error detecting system
C	Celsius or centigrade	EGA	Enhanced Graphics Adapter
Cache	high-speed buffer storage	EMS	Expanded Memory Specification
CAM	constantly addressable memory	EPP	enhanced parallel port
CAS	column address strobe	EPROM	erasable and programmable ROM
CCFT	cold cathode fluorescent tube	EVGA	Enhanced Video Graphics Array
CD-ROM	compact disk ROM	F	Fahrenheit
CGA	Color Graphics Adapter	FAX	facsimile transmission
CGB	Color Graphics Board	FCC	Federal Communications Commission
CH	channel	FDD	floppy disk drive
clk	clock	FG	frame ground
cm	centimeter	FIR	fast infrared
CMOS	complementary metal oxide semiconductor	FM	frequency modulation
codec	compressor/decompressor	Fn	Function
COM	communication	FPU	floating-point unit
CONT	contrast	FRU	field-replaceable unit
CPGA	ceramic pin grid array	GB	gigabyte
CPU	central processing unit	GND	ground
CRT	cathode-ray tube	GUI	graphical user interface
DAC	digital-to-analog converter	HDD	hard disk drive
DACK	DMA acknowledge		

HEX	hexadecimal	MDA	Monochrome Display Adapter
HGA	Hercules Graphics Adapter	MFM	modified frequency modulation
Hz	hertz	Mhz	megahertz
IC	integrated circuit	mm	millimeter
ID	identification	ms	millisecond
IDE	intelligent device electronics	MSB	most-significant bit
IDTR	interrupt descriptor table register	NASC	National Authorized Service Center
IMR	Interrupt Mask register	NC	not connected
in.	inch	NDP	numeric data processor
INTA	interrupt acknowledge	NMI	Non-maskable Interrupt
IPB	illustrated parts breakdown	ns	nanosecond
IR	infrared	NSRC	National Service Response Center
IRR	Interrupt Request register	NTFS	NT file allocation
ISA	Industry Standard Architecture	PAL	programmable array logic
ISR	In Service register	PC	personal computer
I/O	input/output	PCB	printed circuit board
IPC	integrated peripheral controller	PCI	peripheral component interconnect
ips	inches per second	PFP	plastic flat package
IRQ	interrupt request	PIO	parallel input/output
K	kilo (1024)	pixel	picture element
k	kilo (1000)	PJQFP	plastic J-lead quad flat pack
KB	kilobyte	PLCC	plastic lead chip carrier
kg	kilogram	PLL	phase lock loop
kHz	kilohertz	p-p	peak-to-peak
kV	kilovolt	PnP	Plug and Play
lb	pound	PPI	programmable peripheral interface
LCD	liquid crystal display	PROM	programmable ROM
LDTR	local descriptor table register	QFP	quad flat pack
LED	light-emitting diode	RAM	random-access memory
LSB	least-significant bit	RAMDAC	RAM digital-to-analog
LSI	large-scale integration	RAS	row address strobe
LVDS	low voltage differential signaling	RGB	red green blue
M	mega	RGBI	red green blue intensity
mA	milliamps	ROM	read-only memory
max	maximum		
MB	megabyte		

rpm	revolutions per minute
R	read
RTC	real-time clock
R/W	read/write
S	slave
SCSI	Small Computer System Interface
SDLC	Synchronous Data Link Control
SG	signal ground
SIMM	single inline memory module
SIR	serial infrared
SOIC	small outline integrated circuit
SQFP	silver quad flat package
SVGA	Super Video Graphics Array
SW	switch
TCP	thin chip package
TFT	thin film transistor
TQFP	thin-quad flat package
TSC	Technical Support Center
TTL	transistor/transistor logic
tpi	tracks per inch
UART	universal asynchronous receiver/transmitter
USB	Universal Serial Bus
V	volt
Vdc	volts, direct current
VESA	Video Electronics Standards Association
VFO	variable frequency oscillator
VGA	Video Graphics Array
VLSI	very large-scale integration
VRAM	virtual RAM
W	watt
μf	microfarad
μPD	microprocessor
μs	microsecond
Ω	ohm

Contents

Preface.....	xi
Abbreviation	xiii
 Section 1 Technical Information	
Hardware Overview—Front.....	1-2
Liquid Crystal Display (LCD).....	1-3
Power Button and Status LEDs.....	1-4
Keyboard	1-6
NEC VersaGlide	1-6
UltraSlim VersaBay	1-7
Hardware Overview—Sides of the system.....	1-7
Around the Bottom of the System.....	1-9
Around the Back of the System.....	1-10
Hardware Overview—Internal Components	1-11
Battery Pack	1-11
Hard Disk Drive.....	1-12
Diskette Drive.....	1-12
20X CD-ROM Reader	1-12
CPU Board	1-12
Audio Board	1-12
Main Board.....	1-12
Bridge Battery	1-13
System Memory.....	1-13
Memory Map.....	1-13
System Video.....	1-14
Parallel Interface	1-14
Serial Interface.....	1-14
NEC Versa Chip Set	1-15
Intel Pentium P55CLM Microprocessor	1-15
FireStar System Controllers	1-15
USB Controllers	1-15
256K X Flash ROM	1-16
ROM BIOS.....	1-16
VGA Controller	1-16
Parallel Interface	1-17

Keyboard Controller	1-17
PC CardBus Controller	1-17
Sound Integrated Circuit	1-17
Interrupt Controllers	1-18
Power Management Overview	1-19
System Power Management	1-20
Local Power Management.....	1-20
Plug and Play	1-21
Specifications.....	1-22

Section 2 Setup and Operation

Unpacking the System.....	2-1
Hardware Setup.....	2-1
Cable Connections	2-3
Power Sources.....	2-4
Using the AC Adapter.....	2-4
Using the Main Battery Pack.....	2-5
Checking Battery Power Levels.....	2-5
What to Do When Battery Power Gets Low.....	2-5
When to Change the Battery	2-5
Battery Handling.....	2-6
Replacing the Battery Pack	2-7
Battery Precautions.....	2-10
Recharging Battery Precautions.....	2-11
Extending Battery Life	2-11
Operating Controls	2-12
Power Button and Status LEDs.....	2-12
Function Keys (Fn Keys).....	2-14
Smart Power Switch	2-15
Power-on Self-Test (POST).....	2-16
POST Errors.....	2-17
Setup Utility	2-18
Accessing Setup.....	2-19
With an Error at POST	2-19
With No Errors at POST.....	2-19
Setup Utility Main Menu.....	2-19
How to Use Setup.....	2-19

Looking at Screens	2-20
Using Keys.....	2-20
Checking/Setting System Parameters.....	2-21
Setup Menus.....	2-25
Main	2-25
Advanced.....	2-25
Security	2-26
Power Savings	2-28
Exit.....	2-29
Using Power Management	2-29
Power Saving Modes	2-29
Power Management Settings	2-30
Section 3 Troubleshooting	
Quick Troubleshooting	3-1
Helpful Questions	3-4
Section 4 Field Service Guidelines	
Preventive Maintenance	4-1
Cleaning the Notebook Exterior	4-1
Cleaning the Notebook Interior	4-2
Protecting the Disk Drives	4-2
Handling the Battery Pack.....	4-3
Maintaining the LCD Quality	4-3
Disassembly and Reassembly.....	4-3
Required Tools and Equipment	4-4
Battery Pack	4-5
UltraSlim VersaBay	4-5
Removing the Hard Disk Drive	4-8
Keyboard.....	4-10
LCD and Top Cover Assembly.....	4-10
Hinge covers	4-10
Bottom Assembly.....	4-11
Illustrated Parts Breakdown.....	4-12
Service Information.....	4-16
Technical Support.....	4-16
Product Information.....	4-17

Ordering Information from Faxflash	4-17
--	------

Appendix A Connector Locations and Pin Assignments

Appendix B Video Modes

Index

List of Figures

1-1	NEC Versa 5000 Notebook	1-1
1-2	Location of Controls on the Front of the NEC Versa 5000	1-2
1-3	LCD Status Bar and Button Locations	1-4
1-4	Keyboard Layout	1-6
1-5	VersaGlide Location	1-7
1-6	Left Side Features	1-8
1-7	Bottom of the System	1-9
1-8	Back system features.....	1-9
2-1	Connecting the AC Adapter	2-1
2-2	Power and I/O Connector Locations	2-3
2-3	NEC Versa AC Adapter.....	2-4
2-4	Batter Release Latches.....	2-7
2-5	Sliding the Battery Release Latches.....	2-8
2-6	Removing the Battery Pack	2-8
2-7	Installing the Battery Pack.....	2-9
2-8	Replacing the Latch.....	2-10
2-9	Power Button and Status LED Location	2-12
2-10	Setup Main Menu.....	2-19
2-11	Password Override Switch	2-27
4-1	Releasing the Battery Pack.....	4-5
4-2	Release Lever Cover	4-6
4-3	Opening the Cover	4-6
4-4	Pressing the Release Lever	4-7
4-5	Removing the Device	4-7
4-6	Releasing the Spacer	4-8

4-7	Sliding the Drive Towards the Spacer.....	4-9
4-8	Removing the Hard Drive.....	4-9
4-9	Top Cover Subassembly.....	4-11
4-10	NEC Versa Model 5000 Illustrated Parts Breakdown.....	4-15
A-1	CPU Board Layout	A-1
A-2	I/O Board Layout.....	A-2

List of Tables

1-1	Model Configurations	1-2
1-2	Memory Map	1-13
1-3	NEC Versa Series Chip Types and Technologies.....	1-15
1-4	Interrupt Controllers	1-18
1-5	Automatic Power-Saving Features	1-19
1-6	Maximum Performance Default Settings.....	1-21
1-7	Specifications.....	1-22
2-1	I/O Connector Descriptions.....	2-3
2-2	Control and Switch Functions	2-12
2-3	Fn Key Operations	2-14
2-4	POST Error Messages.....	2-17
2-5	Setup Key Functions	2-20
2-6	Setup Parameters	2-21
2-7	Automatic Power-Saving Features	2-30
3-1	Quick Troubleshooting.....	3-1
4-1	NEC Versa 5000 Series Disassembly Sequence	4-4
4-2	Top Cover Components	4-12
4-3	NEC Versa 5000 Series Field-Replaceable Parts.....	4-13
4-4	NEC Service and Information Telephone Numbers.....	4-16
A-1	CPU Board Connectors.....	A-2
A-2	Top Cover Subassembly.....	A-3
A-3	Keyboard/Mouse Connectors	A-3
A-4	Serial Port Connector Pin Assignments	A-3
A-5	CRT Connector Pin Assignments	A-4

A-6	Parallel Printer Pin Assignments	A-4
A-7	Power Connector	A-5
A-8	Hard Disk Drive Connector.....	A-5
B-1	LCD Display Mode Setting (800x600 TFT Color LCD and Simultaneous CRT Display)	B-1
B-2	LCD Display Mode Setting (800x600 TFT Color LCD and Simultaneous CRT Display)	B-3
B-3	Panning Video Mode (800x600 TFT Color LCD and Simultaneous CRT Display)	B-4

Section 1

Technical Information

The NEC Versa 5000 Series notebook computer is lightweight, compact, and fully IBM compatible.



This service manual covers only the NEC Versa 5060 and 5060X models. All figures in this manual reflect these models.



Figure 1-1 NEC Versa 5000 Series Notebook

This section of the manual provides system configuration information, including an overview of hardware and interface components. See the following table for a system-specific breakdown of the hardware.

Table 1-1 Model Configurations

Feature	NEC Versa 5060	NEC Versa 5060X
CPU	Intel Pentium® with MMX technology P55CLM/166 MHz	Intel Pentium® with MMX technology P55CLM/166 MHz
On-Board DRAM	16-MB	16-MB + 16-MB installed in slot
Video Memory	2-MB	2-MB
Hard Disk Drive	1.6 GB	2.1 or 3.2 GB
CD-ROM Reader	20X CD ROM Reader	20X CD ROM Reader
Color LCD	12.1" Super VGA (SVGA),TFT Color Display	13.3" Extended Graphics Array (XGA),TFT Color Display

HARDWARE OVERVIEW—FRONT

Take a moment to become familiar with the location and function of controls located on the front of the system.

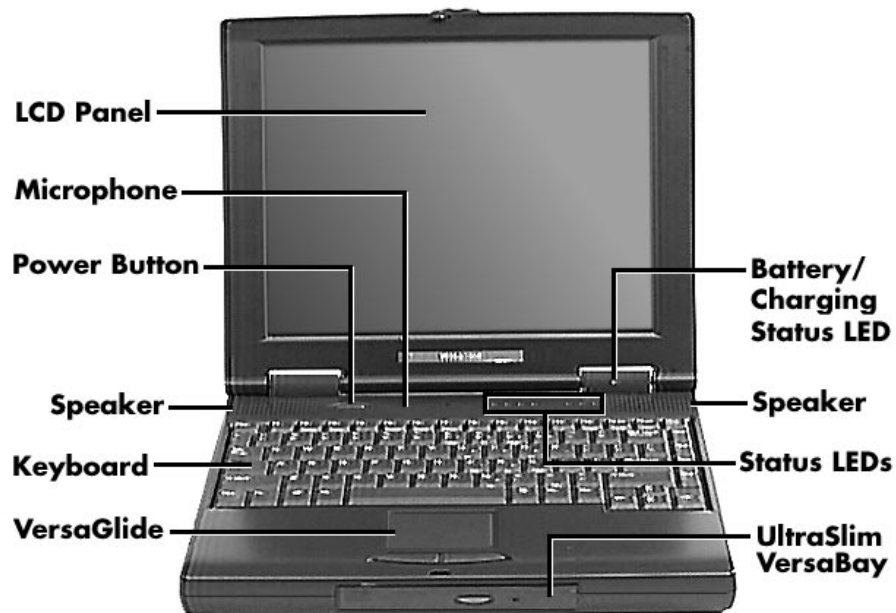

Figure 1-2 Location of Controls on the Front of the NEC Versa 5000

Liquid Crystal Display (LCD)

The LCD operates with the NeoMagic NM2160 controller. The controller supports XGA and SVGA, uses a 64-bit accelerator with a Peripheral Component Interconnect (PCI) interface. The LCD also supports VESA timing.

The NEC Versa 5060 LCD features the following:

- 12.1-inch Super Video Graphics Array (SVGA) TFT high-resolution active matrix SVGA color display
- 0.3075 mm dot pitch
- 18-bit digital interface
- 800 x 600 resolution
- 65,536 colors.

The NEC Versa 5060X LCD features the following:

- 13.3-inch Extended Graphics Array (XGA) TFT high-resolution active matrix XGA color display
- 0.264 mm dot pitch
- 18-bit digital interface with LVDS
- 1024 x 768 resolution
- 65,536 colors.

Additional LCD panel features:

Power LED that indicates the current power status. This LED is visible with the LCD panel opened or closed.

Another video feature includes a CRT port on the system's rear panel that allows the user to connect an optional monochrome or color external display to the system. The computer can support the LCD and external display simultaneously.

Power-saving features for controlling the LCD's backlighting include the ROM-based hot key combination Fn F5, and Auto Setup power management settings. See Section 2, Setup and Operation, for information on using these settings. In addition, the automatic LCD status feature conserves the backlight.

Power Button and Status LEDs

NEC Versa provides a Power button and LEDs to track system status. Descriptions of these features follow the figure.

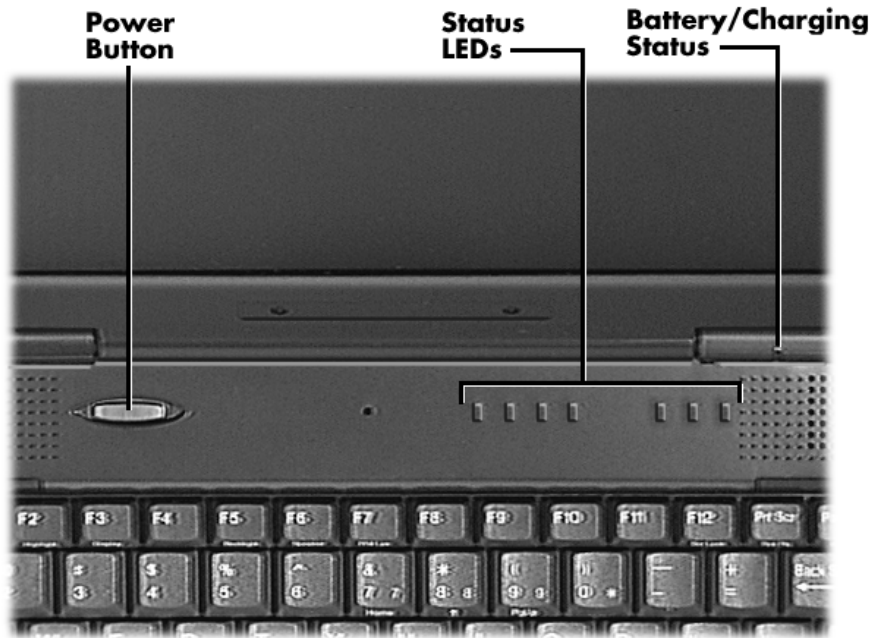



Figure 1-3 LCD Status Bar and Button Locations

- Power Button — The Power button is located on the chassis just below the LCD. It turns NEC Versa 5000 power on and off. Press the button to turn power on; press it again to turn power off.
 - When power is on, the Power LED to the right of the Power button lights. (The Power LED is the left-most LED in the row of LEDs.) See “Setup Parameters” in Section 2 for information about defining this button as a Suspend/Resume button.
 - If your system is in Suspend mode or has gone into Save to Disk mode, pressing the Power button puts the system in Operation mode.

 After turning off the system, wait 5 seconds before turning it back on. This gives system components a chance to power down properly.



- The Battery/Charging Status LED is located on the right-hand LCD hinge and lights to indicate the following:
 - Green – the battery is fully charged and the system is connected to AC power.
 - Amber – the battery is recharging.
 - Off – the AC adapter is disconnected or the battery is not installed.
- A bank of status LEDs is located on the chassis at the top of the keyboard to the right of the Power button. These LEDs are identified by icons and include the following (described from left to right):



- The Power LED lights in the following sequence to indicate system operation status.
 - lights green when running on AC power.
 - blinks green when the system is in Suspend mode.
 - lights amber when running on battery power with a charged battery.

The Power LED also warns you about a low battery state. The system emits a beep and the Power LED behaves as follows:

- blinks amber when battery power is low.
- flashes amber when battery power is extremely low.

The Power LED remains unlit under the following conditions:

- if the system is not connected to AC power and the battery is not charged or installed.
- the system is not powered on.
- the system is in Save to Disk mode.



- Hard Disk Drive – Lights when the NEC Versa 5000 writes data to or retrieves data from the hard disk drive.



- CD-ROM Reader – Lights when data is read from a compact disc in the CD-ROM drive.



- Diskette Drive – Lights when data is written to or retrieved from the 3.5-inch diskette drive.



- Caps Lock – Lights when Caps Lock is on.



- Num Lock – Lights when Num Lock mode is active.
-

└ — Scroll Lock – Lights when the Scroll Lock is on.

Keyboard

The built-in, 85-key keyboard (U.S.) or 79-key keyboard (UK and Germany) uses the standard QWERTY format. The keyboard provides 12 function keys and 7 cursor control keys, with an Fn key for ROM-based key functions. The numeric keypad is embedded in the standard key layout.

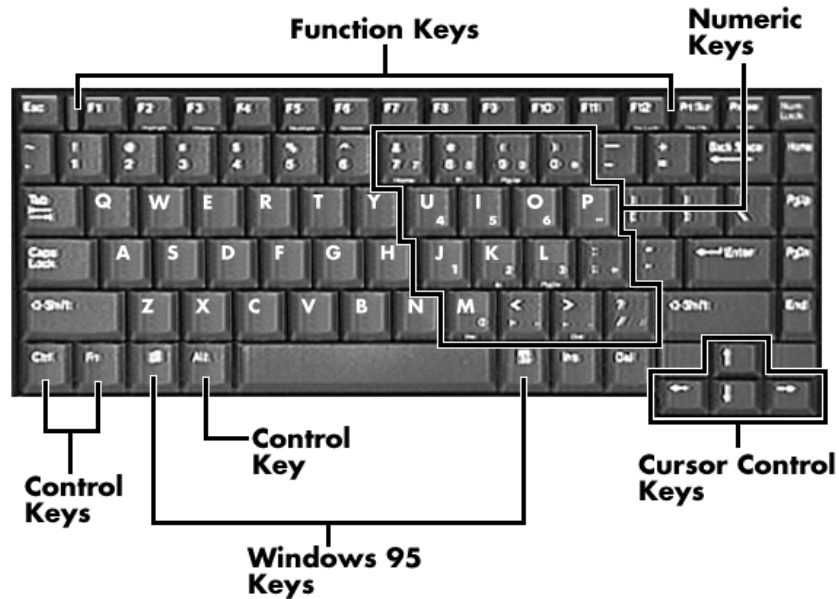

Figure 1-4 Keyboard Layout

NEC VersaGlide

The NEC VersaGlide is a built-in mechanism that functions as the system's mouse. It controls the on-screen pointer (cursor). To use the VersaGlide, move your finger across the NEC VersaGlide pad, and the cursor follows. The buttons below the NEC VersaGlide allow the user to select or deselect menu items. Tap and double-tap are supported on the VersaGlide pad.

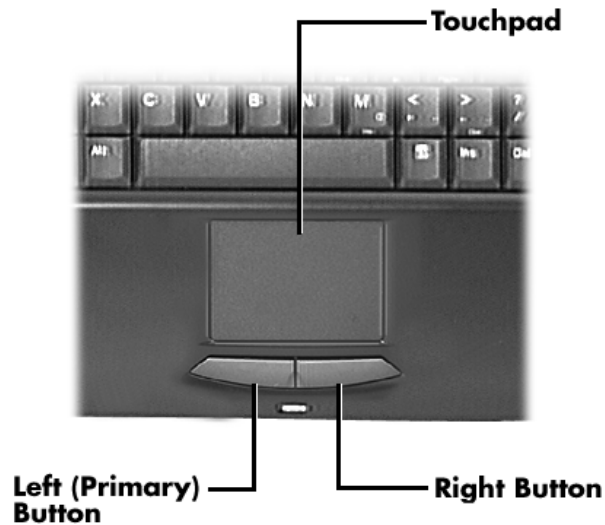

Figure 1-5 VersaGlide Location

UltraSlim VersaBay

A standard 1.44-MB diskette drive comes installed in the UltraSlim VersaBay slot on the front of the computer. The UltraSlim VersaBay expansion slot lets the user replace the standard diskette drive with the 20X CD-ROM reader that also ships with the system. In addition to the CD-ROM reader, the UltraSlim VersaBay accepts NEC options including a Weight Saving Module.

HARDWARE OVERVIEW—SIDES OF THE SYSTEM

Your NEC Versa 5000 comes with many features on the left side of the system. The right side of the system features a port for securing the PortBar and air vents. Keep the air vents clear to allow for proper air circulation.

! **CAUTION**

Do not block the air vents. Doing so can damage the system by causing it to overheat.

The features found on the left side of the system are shown in the following figure. Descriptions follow the figure.

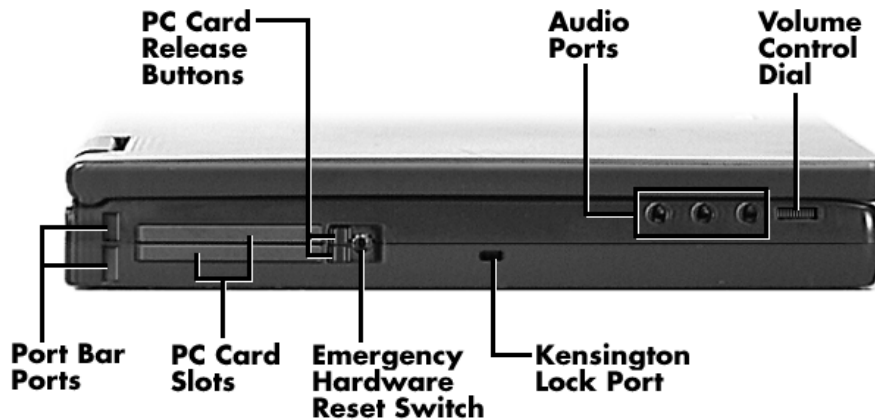

Figure 1-6 *Left side features*

- **PC Card Release Buttons** — Press the Release button when you want to remove an installed PC card.
 - **Audio Ports** — Use these ports to attach your external audio options, including the following:
 - **Microphone** — Connects to an external microphone for monophonic recording or amplification through the unit. Plugging in an external microphone disables the built-in microphone.
 - **Stereo Line In** — Lets you use another audio system, like a home stereo, as an input source. Use a cable to connect to the Line-Out port on the other audio system to record or play.
 - **Headphones** — Lets you plug in stereo headphones or powered speakers.
 - **Volume Control Dial** — Turn the volume control dial clockwise to increase speaker volume, or counter-clockwise to decrease speaker volume.
 - **Kensington Lock Port** — Use this port for added security by attaching a Kensington Lock.
 - **Emergency Reset Switch** — This recessed switch lets you restart your system. Use a pointed object, like a straightened paper clip, to push in the Reset switch. Do not use a pen or pencil to push the reset switch. Use this button only if your system locks up, fails to respond to key-strokes, or fails to respond to the power button.
 - **PC Card Slots** — Two PC card slots let you insert one or two Type II PC cards, or one Type III PC card.
-

- **PortBar Port** — Use these ports to secure the PortBar. A matching Port-Bar port is located on the right side of the system. Two others are located on the back.

Around the Bottom of the System

The bottom of the NEC Versa 5000 is the location of the system's memory module sockets, password override switch, battery pack release latches, VersaBay release lever and hard disk drive bay, as described next.

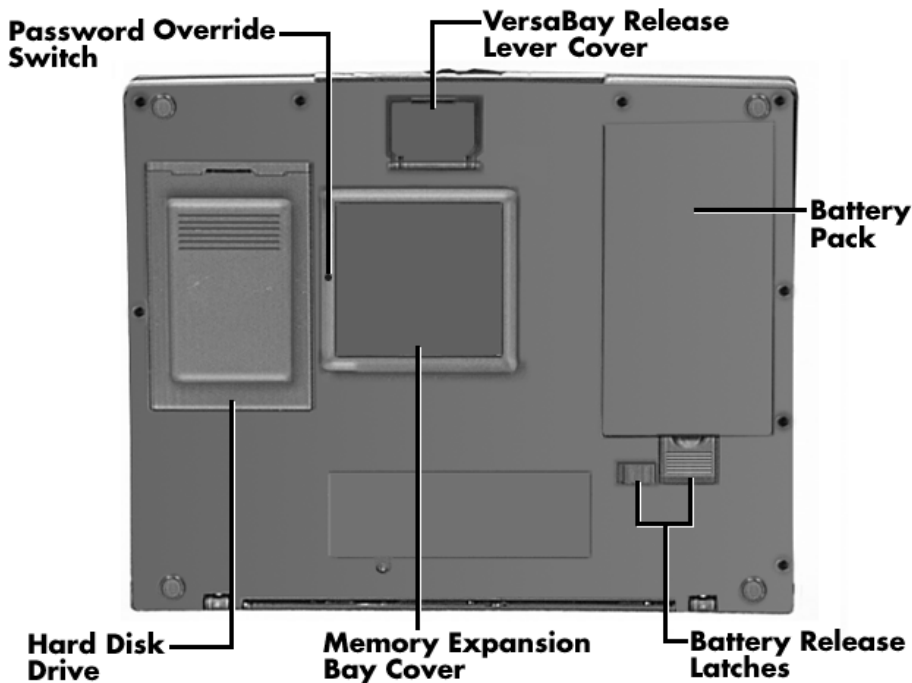

Figure 1-7 Bottom of the system

- **Password Override Switch** — This recessed switch removes any settings that you made in the Setup utility, including your system password.

To remove your password, power on your system. Use a pointed object, such as a straightened paper clip, to push in the switch. Power off, and then power on to restart your computer. Go into the Setup utility and set a new password. Reset any other system settings that you may have changed.

- **VersaBay Release Lever Cover** — Open the release lever cover to access the VersaBay Release Lever. Pushing the lever towards the front of the system releases the device currently installed in the VersaBay.



Opening the VersaBay Release Lever Cover immediately puts the system into Suspend mode. After installing the VersaBay device, press the Power button to resume the system from Suspend.

- **Battery Pack** — A Lithium-Ion (Li-Ion) rechargeable battery pack comes installed in this bay on the bottom of the NEC Versa.
- **Battery Release Latches** — Lets you remove the battery pack installed in the battery bay.
- **Memory Expansion Bay Cover** — Pop open the protective cover to access two RAM expansion sockets for small outline double inline memory modules (SO-DIMM).
- **Hard Disk Drive** — A removable hard disk drive ships standard with your system and is located on the bottom of the unit. Depending on your configuration, this bay contains a 1.6-, 2- or 3-gigabyte (GB) hard disk drive. (Chapter 4 describes how to remove this drive.)

The drive letter assigned to 1.6-GB and 2-GB hard drives is C:. If your system ships with a 3-GB drive, it is partitioned into two drives. Drive letters are C: and D:.

Around the Back of the System

System ports for connecting your NEC Versa 5000 to optional devices (like a printer or external monitor) are located on the back of the system. For an understanding of each feature, see the descriptions that follow the figure.

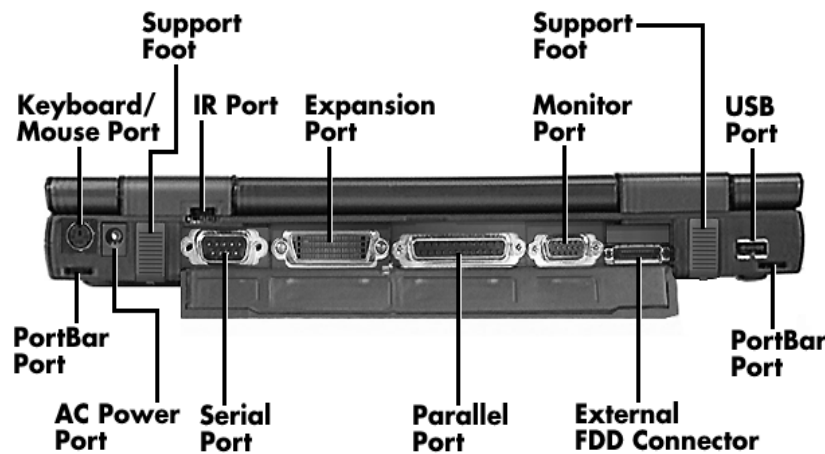

Figure 1-8 Back system features

- **Keyboard/Mouse Port** — Use the standard PS/2 port to connect an external PS/2-style mouse or a PS/2-style keyboard to the system.
- **Support Feet** — Slide the two support feet down from the back of the unit to tilt your system forward for more comfortable keyboard access.
- **Infrared (IR) Port** — Use this port to transfer files between your NEC Versa and an IR-equipped desktop or notebook computer. You can also print to an IR-equipped printer without using cables.
- **Expansion Port** — Use this 120-pin port to connect to the NEC PortBar 5000.
- **Monitor (Video) Port** — Use this 15-pin port to attach an external monitor to your NEC Versa 5000. You can run the LCD display and the external monitor simultaneously or run either alone.
- **USB Port** — Use this port to connect a USB device or devices to your NEC Versa system.
- **PortBar Ports** — Use these ports to secure the optional PortBar. PortBar ports are located on the back and sides of the system at each end.
- **External Diskette Drive Connector** — Connect the External Diskette Drive cable that came with your system to this port. Using the FDD connector frees up the VersaBay for installing the 20X CD-ROM reader.
- **Parallel Port** — Use this 25-pin port to connect a parallel printer or other parallel device. This port provides ECP mode support. The ECP standard provides you with a greater transfer speed than the conventional parallel port. It also supports bi-directional and uni-directional protocols.
- **Serial Port** — Use this 9-pin port to connect an external modem or other serial device.
- **AC Power Port** — Lets you attach the NEC Versa 5000 to the AC power source using the AC adapter that comes with your system. Keep the system connected to AC power whenever possible to keep the battery pack and internal CMOS battery charged.

HARDWARE OVERVIEW—INTERNAL COMPONENTS

Review the following sections for a description of the system's internal hardware.

Battery Pack

The system uses a rechargeable Lithium-Ion (Li-Ion) battery as its transient power source. The battery pack installs in the compartment next to the UltraSlim VersaBay on the bottom of the NEC Versa.

Hard Disk Drive

A standard 2.5-inch 1.6-GB 9.5 mm, 2.1-GB 12.7 mm or 3.2-GB 12.7 mm hard disk drive ships with the system.

Diskette Drive

The interchangeable 3.5-inch 1.44 MB diskette drive installs in the front of the system in the UltraSlim VersaBay slot.

20X CD-ROM Reader

A 20X CD-ROM reader ships with the NEC Versa 5000. The interchangeable twenty-speed CD-ROM reader features the latest in CD-ROM technology. It installs in the front of the system in the UltraSlim VersaBay slot.

CPU Board

The CPU board is located between the Main board and Fan/Heat Sink assembly. The CPU board is part of a subassembly, which includes a heat sink, fan and the CPU board.

Audio Board

The audio board provides the NEC Versa system with its audio capabilities via line-in/line-out jacks, and headphone/microphone jacks. It is situated on top of the main board. Audio board integrates the following features:

- ESS Technology Plug and Play support
- ES1869A
- Integrated Music Synthesis, ESFM™ and Stereo Digital to Analog Converter (DAC) FM Synthesizer
- 16 bit Stereo CODEC
- 4.0KHz to 44.1KHz Sampling Rate
- 7 Channel Mixer.

Main Board

The system Main board contains peripheral subsystems including serial, parallel and video ports, and CPU. It is located underneath the keyboard. Refer to Appendix A for a list of connectors.

Bridge Battery

The bridge battery saves the memory contents and system status for up to 5 minutes while in Suspend mode. It is connected to the Audio board via connector P11. The AC adapter maintains voltage in the bridge battery when the system is powered on or off. The bridge battery stores 3.6 Volts, 70 mAH.

SYSTEM MEMORY

The CPU board provides 16 MB (3.3 V SO-DIMM) of standard RAM.

Optional SO-DIMMs with a value of 16-MB, 32-MB and 64 MB can be added to increase system memory Versa 5060/5060X: Maximum 80-MB, Versa 5080/5080X: Maximum 144-MB.

In addition, 256-KB of read-only memory (ROM), 1 x 28F020, enables the system BIOS to be flashed.

The system provides 2 MB of video RAM (50-ns HyperPage mode, self-refresh).

The following Cache RAM is provided:

L1: 32 KB (Internal Pentium)

L2: 256 KB write back (External).

Memory Map

The system supports system and video shadowing, both controlled through complementary metal oxide semiconductor (CMOS). The system supports BIOS as a cacheable area with write protection. Table 1-2 lists the system's memory map.

Table 1-2 Memory Map

Memory Space	Size	Function
0000000h-009FFFFh	640 KB	DOS Applications & Optional Memory Space Gap
00A0000h-00B7FFFh	96 KB	Video (VGA) Graphics Memory
00B8000h-00BFFFFh	32 KB	Text Mode Memory (SMM Space)
00C0000h-00C7FFFh	40 KB	Video (VGA) BIOS
00C8000h-00D7FFFh	128 KB	PCMCIA Window and USB (Extended Memory or Upper Memory Block)
00D8000h-00DFFFFh	32 KB	Boot Block Code CMOS Save Area
00E0000h-000FFFFFFh	64 KB	System BIOS ROM
To -00FFFFFFh	16 MB	Total Base Memory
To -FFFEFFFFh	80 MB	Total Expansion Memory

SYSTEM VIDEO

The system's LCD operates using the NeoMagic NM2160 Controller. Video signals travel from the controller through the system's 15-pin D-SUB connector using 3.3/5 volts.

System video integrates a PCI-bus interface. The system ships with 2 MB Video RAM (VRAM). It supports video modes up to 1024 x 768 with 64K colors in LCD mode.

See Appendix B for a list of Video modes.

PARALLEL INTERFACE

The system's parallel interface integrates National Semiconductor's PC87338 chip with a 25-pin D-subconnector. The port is located on the system's rear panel.

The modes of operation available for a PC87338 chip are:

- compatibility mode
- nibble mode
- byte mode
- Extended Capabilities Port (ECP)

The user selects between three parallel interface modes using Auto Setup. These include unidirectional, bidirectional, extended or enhanced. Unidirectional mode sends data output from the standard ISA port only. Bidirectional mode sends data using the standard ISA port or PS/2 technology. Enhanced mode enables high speed data transmission to occur using either the unidirectional or bidirectional modes.

The default parallel port address is **378h** and the interrupt level is **IRQ07**. Pin locations for the parallel interface are listed in Appendix A.

SERIAL INTERFACE

The RS-232C serial port is a 9-pin connector on the system's rear panel. The serial port consists of a 16550A and 16450 compatible serial port controller with a programmable baud rate up to 115,200 bps. The serial port connects an RS-232C device or an external modem. The default serial port address is 3F8h and the interrupt level is IRQ04.

NEC VERSA CHIP SET

Refer to Table 1-3 for a quick summary of chip types used in the system. See the Abbreviations section at the beginning of this manual for a translation of chip technologies.

Table 1-3 NEC Versa Series Chip Types and Technologies

Chip	Manufacturer	Description	Technology
Intel Pentium P55CTT80503	Intel	166 MHz CPU	320-pin TCP
82C700(FireStar)	Opti	FireStar System Controller	432--pin BGA
82C861(FireLink)	Opti	USB Controller	100-pin TQFP
N28F002BC-90	Intel	256k x 8 Flash ROM	32-pin PLCC
NM2160	NeoMagic	VGA Controller	208-pin FQFP
PC97338	National Semiconductor	Diskette Controller, IDE, Parallel Interface	100-pin TQFP
H8/3434	Hitachi	Keyboard Controller	64-pin TQFP
PCI1131	Texas Instruments	PC Card Controller	208-pin QFP
ES1869	ESS Technologies	Sound Controller	100-pin PQFP

Intel Pentium P55CLM Microprocessor

The 166 MHz Intel Pentium microprocessors with MMX technology used in the NEC Versa Series computer is built on Intel's advanced 2.5V BiCMOS silicon technology. The CPU has on-chip dual-processing, a local multiprocessor interrupt controller, and power management features. NEC adopted the chip specifically for its pipelined Floating Point Unit (FPU), and local interrupt management.

FireStar System Controllers

NEC implements Opti's 64-bit single chip controller (82C700) for the NEC Versa 5000 Series notebook's subsystems including the DRAM controller, Second Level Cache Controller and PCI Bus interface. The FireStar PCI set features include:

- 3.3V EDO DIMM (70-ns) support
- direct mapped organization write-back policy
- fully synchronous 33 MHz PCI bus interface.

USB Controller

The Opti 82C861 FireStar chip is a PCI USB controller. The controller based on Open HCI standard and supports hot plug in and unplug.

The chip features include:

- USB Specification Rev 1.0
- Open HCI Specification Rev 1.0a.

256K X Flash ROM

The N28F002BC-90 flash ROM is a 32-pin, plastic lead chip carrier (PLCC). The chip allows easy updates to the system's BIOS if needed. More specifically, the ROM is flashed electronically, installing the latest BIOS revisions to the system. It is possible to reprogram the BIOS up to 100,000 times. See Section 2, Setup and Operation, for BIOS update procedures.

The N28F002BC-90 provides the system upgrade capability as well as the following:

- 256 KB memory
- Quick-Pulse Programming Algorithm
- 150 nanoseconds (ns) maximum access time
- ETOX Nonvolatile flash technology
- CMOS low power consumption

ROM BIOS

The system uses a Flash ROM known as the system's ROM BIOS to store machine language programs. The BIOS size is 256 KB, consisting of the system utility (for PC cards, Auto Setup), system BIOS, video BIOS, and power management.

The BIOS programs execute the power-on self-test (POST), initialize CPU controllers, and interact with the LCD indicator panel, diskette drive, hard drive, communication devices and peripherals. The system BIOS also contains Auto Setup and provides VGA controller support. The ROM BIOS is copied into RAM (shadowing) for optimum performance.

The ROM BIOS contains both the system and video BIOS. The system BIOS is located in the upper portion of the device; video BIOS is located in the lower portion. System BIOS is located between 00F0000h-000FFFFh.

The BIOS often changes after the product release to provide enhanced features or bug fixes. To acquire the latest BIOS release, the ROM is flashed electronically allowing the BIOS update to occur without removing the ROM. See Section 2, Setup and Operation, for BIOS upgrade procedures.

VGA Controller

The NeoMagic NM2160 is a PCI 128-bit Graphics Accelerator. The integrated programmable linear address feature accelerates the graphics user interface (GUI) performance. The controller also supports Hardware Multimedia and VESA interface standards. The controller provides advanced power management that helps to minimize power usage in the following modes:

- normal operation
- Standby (sleep) mode
- panel off power saving modes.

Parallel Interface

The PC87338VJG chip is a 100-pin Thin Quad Flat Plastic (TQFP) chip. The controller changes 8-bit parallel data into serial data and writes the data to the diskette. Conversely, the serial data is transmitted from the diskette into parallel data, where it remains until the read operation takes place.

- Additional PC87338VJG chip operations include:
 - ISA compatibility
 - low-power CMOS with enhanced power-down mode

Keyboard Controller

The keyboard controller (H8/3434) supports a PS/2-style keyboard and, mouse. Refer to Appendix A for keyboard interface connector pin assignments.

When data is written to the output buffer, the controller generates an interrupt, and requests the CPU to receive the data. The controller automatically adds an even parity bit to the data sent and waits for a response. The device must acknowledge that the data was successfully received by sending a response to the controller for each byte of data received.

PC CardBus Controller

The Texas Instruments PCI1131 controller interfaces with the PCI bus, PC CardBus socket and configuration registers to provide:

- compliant with PCI 2.1 and 1995 PC card standards
 - CardBus slots with hot insertion and removal
 - independent Read and Write buffers for each direction
 - burst transfers to maximize data throughput on the PCI CardBus bus.
-

Sound Integrated Circuit

The ESS Technologies chip set ES1869A provides dynamic audio circuitry with the following:

- Audio digital processor
- Plug and Play support
- High-performance 16-bit Stereo Codec
- Full-duplex operation for simultaneous record and playback
- Analog joystick quad timer and digital joystick support.

Interrupt Controllers

Using interrupts, it is possible to change the system's code sequence. To change the sequence, reassign the interrupt-levels. Fifteen interrupts can be used with a cascade connection of two 82C59 interrupt controllers.

Interrupt-level assignments 0 through 15 are listed in Table 1-4, in order of decreasing priority.

Table 1-4 Interrupt Controllers

Channel	Device
IRQ00	System Timer
IRQ01	Keyboard
IRQ02	Second Interrupt Controller
IRQ03	COM2 (internal IR port)
IRQ04	COM1 (internal serial port)
IRQ05	Sound Chip, MIDI (default)
IRQ06	Floppy Disk Drive Controller
IRQ07	LPT1 Default (internal printer port)
IRQ08	Real Time Clock
IRQ09	USB
IRQ10	Not Used
IRQ11	CardBus controller
IRQ12	Internal Glide Pointer or External PS/2 Mouse
IRQ13	Co-Processor
IRQ14	Primary IDE (Hard Disk Drive)
IRQ15	Secondary IDE (CD-ROM)

POWER MANAGEMENT OVERVIEW

Power Management in the NEC Versa lets you conserve energy, save battery power, extend the life of your LCD backlight, and protect against data loss due to low battery power.

Set some features to function automatically or activate them manually with the keyboard or a button. It is wise to keep Power Management features enabled, even when using AC power.

The system ships with many power-saving features already enabled. See the following table.

Table 1-5 Automatic Power-Saving Features

Device	Default Timeout	Comment
Idle Mode	On	Idle mode slows down the CPU during brief periods when the system is not busy.
Standby Timeout	4 minutes	Specifies how long the system is in Idle mode before entering Standby mode. Standby turns off various system devices including the screen.
Auto Suspend Timeout	10 minutes	This setting specifies how long the system remains in Standby mode before entering Suspend.
Hard Disk Timeout	2 minutes	Stops the hard disk motor when the hard disk is not accessed for the specified timeout.
Video Timeout	2 minutes	Shuts off video screen after the timeout specified elapses.
CD-ROM Timeout	45 seconds	Specifies how long the CD-ROM reader remains inactive before being turned off.



In Windows 95 systems, power management settings under Windows override the settings established in Setup.

You can change the timeout period for any of the devices using Setup. See Section 2 for Setup utility procedures.

Use the **FnF7** key combination to set the power management level you can toggle between Highest Performance, Longest Battery Life, Custom Power Management, and Off. Default values change depending on the type of power management you use.

System Power Management

NEC Versa system power management consists of the following operation modes. These modes are:

- **Active Mode** • In active mode, the system uses no power management. It operates with the default clock speed. The system continues to run at this speed unless overwritten by the power management features.
- **Standby Mode** • The system switches automatically to Standby mode. This eliminates unnecessary power consumption when you operate the system on battery power or AC. Standby mode shuts down the LCD panel, providing privacy as well as power savings.
- **Suspend Mode** • Suspend mode causes the CPU to power down, local devices to shut down, and register values to be stored in RAM. System RAM is put into a slow refresh state.

The system resumes Active mode when you press the Suspend button, or the system is set to resume at a certain time of day. Suspend mode lets you save power without first saving the working data.

Press the **Fn-Esc** keys simultaneously to enter Suspend mode when you need to be away from the system for a short period of time and want to return to where you left off.

In addition, to quickly activate the Save to File feature, press the **Fn-Power Button** buttons simultaneously. This shuts down the system, and saves the current working data to a file.

Local Power Management

Use Auto Setup to select one of four power management settings for local devices. These include Longest Life, Maximum Performance, Customize, and Power Management Off. The power management levels are also available during AC operation. The NEC Versa computer ships with Longest Life as the default power management setting. See Section 2 for specific procedures on using Auto Setup to select the power management settings.

When set to Longest Life, CMOS will set local device timeout values, a local standby timeout value, and a suspend timeout value to ensure the longest battery life. The Maximum Performance setting selects CMOS values that will provide minimal energy savings and a shorter battery life. The customize settings enable end-users to set the timeout values of their choice. The Power Management Off selection terminates all power management timers.

Local device timers in the system control power consumption in the LCD and Hard Disk Drive. Table 1-6 shows NEC Versa Series Maximum Performance default power management timers.

Table 1-6 Maximum Performance Default Settings

Power Management Mode	Automatic Suspend	Hard Disk Timer	Video Timeout
Longest Life	10 minutes	2 minutes	2 minutes
Maximum Performance	30 minutes	2 minutes	6 minutes
Custom	10 minutes	2 minutes	2 minutes

PLUG AND PLAY

The NEC Versa features Plug and Play functionality. Plug and Play is the ability of the BIOS and/or operating system to dynamically assign system resources to a newly installed device without user intervention.

For example, you can suspend the system, add a monitor or device to the VersaBay, and when you resume working, the NEC Versa recognizes the devices that have been connected to it. Similarly, you can remove external devices in Suspend mode and the NEC Versa detects the status when resumed.

The NEC Versa is capable of having a keyboard or mouse added or removed while in the Power On mode. This capability is known as a Hot Swap. Changes made while in Suspend Mode are classified as a Warm Swap.

SPECIFICATIONS

Table 1-7 provides a complete list of NEC Versa Series system specifications.

Table 1-7 Specifications

Item	Specification
Chassis Configuration	
Size	Width: 12.0 in. (306 mm) Depth: 9.6 in. (243 mm) Height: 1.5 in. (38 mm) Weight: 4.9 lb (2.23 kg) with Weight Saving Module 5.3 lb (2.4 kg) with FDD 5.5 lb (2.5 kg) with CD-ROM Exact weight depends on options
Keyboard	PS/2 compatible, 85-key (both U.S. and International) with QWERTY-key layout (International keyboards are country-specific)
Device Slots	Two PC Card slots that support up to two optional cards-oriented one on top of the other One 3 1/2-inch x 0.75-inch high slot, front access, for standard 1.44 diskette drive, optical diskette drive 120 MB or 20X CD-ROM reader.
Power	100 to 240 Volts AC at 50 or 60 Hz Output Voltage — 19 V DC, 2.6 A (49.4 W)
Battery Pack	Weight — .99 lb (.51 Kg) Voltage — 14.4 V Capacity — 2400 mAH Battery Life — Approximately 1.5 to 3 hours (depending on model and power management settings) Recharging Time — Approximately 3 hours when the system is on or off Bridge Battery — Backs up memory contents up to 5 minutes in Suspend mode
Front Panel Controls	Power Button
LEDs	Battery/Charging Status LEDs Status LEDs — Power, Hard Disk Drive, CD-ROM Reader, Diskette Drive, Caps Lock, Number Lock and Scroll Lock.

Table 1-7 Specifications (cont'd)

Item	Specification
System Board	
CPU	Intel Pentium 166 MHz
Clock Speed	166 MHz
CPU Bus Speed	66 MHz
Flash ROM	256 KB: 28F002
Connector Support	Parallel — 1 port, 25-pin D-sub Serial — 1 port, 9-pin D-sub Infrared — 1 on back of system VGA — 1 port, 15-pin high-density D-sub External Keyboard/External Mouse — 1 port, PS/2, 6-pin MiniDin; exclusionary use or both supported with optional Y-adapter Expansion — 1 port, 120-pin for optional PortBar 5000 Mono MIC IN — 1 port, 3-pin, Mini Pin Jack Stereo Headphones/Line-Out — 1 port, 3-pin, Mini Pin Jack, .5 watts per channel Stereo Line-In — 1 port, 3-pin, Mini Pin Jack USB Port — 1 port, 4 pin External Diskette Drive — 1 port for the external connection of the diskette drive, 26 pin DC In — 1 port, for AC adapter cable
Memory	
System Memory	16 or 32 MB high-speed EDO access 60 ns
Optional	Two so-DIMM sockets (for expansion memory) Expandable in 16-MB, 32-MB increments Maximum 80-MB (by adding 2 so-DIMM of 32-MB)
Video RAM	2 MB
Video Interface (VGA)	
LCD NEC Versa 5060	12.1-inch high-resolution active matrix Thin Film Transistor (TFT) Super VGA (SVGA) color display, 800 x 600 pixels, 0.3075 mm dot pitch, 65,536 colors
LCD NEC Versa 5060X	13.3-inch high-resolution active matrix Thin Film Transistor (TFT) Extended Graphics Array (XGA) color display, 1024 x 768 pixels, 0.264 mm dot pitch, 256,000 colors

Table 1-7 Specifications (cont'd)

Item	Specification
Internal Device Support	
Diskette Drive	User-removable 3 1/2-inch, 1.44-MB, installs in UltraSlim VersaBay slot or connects to the external FDD connector
Hard Disk Drives	IDE interface (built-in), System ships with a 1.6, 2.1 or 3.2-GB hard disk drive
20X CD-ROM Reader	User-removable twenty-speed (20X) CD-ROM reader, installs in UltraSlim VersaBay slot
External Device Support	
CRT	Displays up to 1280 x 1024 resolution x 256 colors
Mouse	PS/2-compatible mouse
Keyboard	Built-in 85 key keyboard with 12 programmable function keys, embedded numeric keypad and special function control keys, dedicated screen control keys, and inverted "T" cursor keys / IBM enhanced 101/102-key compatible keyboard
Software	
Standard	<p>Window 95</p> <p>LapLink[®]</p> <p>McAfee VirusScan[™]</p> <p>McAfee WebScan[™]</p> <p>CyberMedia[®] First Aid[®] 97</p> <p>Prodigy Internet[™]</p> <p>America Online[®]</p> <p>Microsoft Internet Explorer</p> <p>CompuServe[®] 3.0</p> <p>Official Airline Guide (OAG[®])</p> <p>Microsoft Internet Explorer [™]</p>
Recommended Environment	
Operation	<p>Temperature: 41° to 95°F (5° to 35°C)</p> <p>Relative Humidity: 20% to 80% (No condensation)</p>
Storage	<p>Temperature: -4° to 140°F (-20° to 60°C)</p> <p>Relative Humidity: 10% to 80% (No condensation)</p>

Table 1-7 Specifications (cont'd)

Item	Specification
Administrative Compliance	U.S.: FCC, UL Canada: CSA, DOC Germany: VDE, TUV, CE Australia: AS for AC adapter only
Other Compliance	PC97 Compliance Energy Star VESA & PnP VESA PnP ISA

Section 2

Setup and Operation

This section provides setup and operation information for the NEC Versa series system (including cabling, power-on verification and using the Setup utility, from this point on referred to as “Setup” only).

UNPACKING THE SYSTEM

Find an area away from devices that generate strong magnetic fields (electric motors, transformers, etc.). Place the shipping carton on a sturdy surface and carefully unpack the system. The carton contents include the system, CD-ROM reader, AC adapter, AC power cord, battery, software CDs, and user documentation.

HARDWARE SETUP

When connecting power and signal cables, do the following.



Always plug the AC adapter cord into an easily accessible outlet.

1. Connect the AC adapter cable to the power port on rear of the NEC Versa.
2. Plug one end of the AC power cable into the AC adapter and the other end into a properly grounded 120- or 240-volt wall outlet.

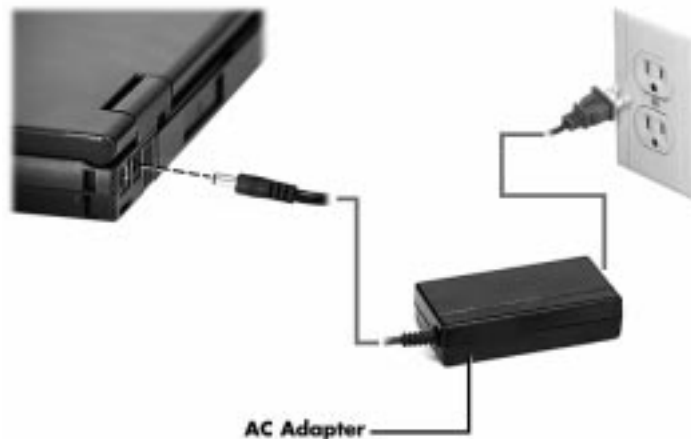

Figure 2-1 Connecting the AC Adapter



Do not cover or place objects on the AC adapter. This will allow heat to dissipate properly.

3. Ensure that all connections are properly seated and secure.



CAUTION

This equipment uses an ungrounded power cable. Replace the cord if it becomes damaged. U.S. and Canadian replacement cords must be UL-approved (CSA certified in Canada) type SPT-2, 18 AWG, 2-conductor cord with a permanently attached NEMA type 5-15P plug at one end, and a permanently attached connector body on the other. Cord length may not exceed 15 feet. Outside the U.S. and Canada the cord must be rated for at least 250VAC at 10 amps, and must indicate international safety agency approval. The plug must be a type appropriate for the country where it is used.

Obtain replacement cords at an authorized service center. The replacement must be of the same type and voltage rating as the original cord.

4. To power on, locate the Power button just below the LCD screen near the left hinge and push it in. To power off the system, use the Windows 95 Start menu shut down selection.



If operating the system on DC power, verify that the system has a charged battery pack installed.

Cable Connections

Figure 2-2 shows the external connectors for the system. Where appropriate, secure cables by tightening the cable holding screws.

Table 2-1 describes the I/O connectors on the rear of the system. For pin assignments, see Appendix A.

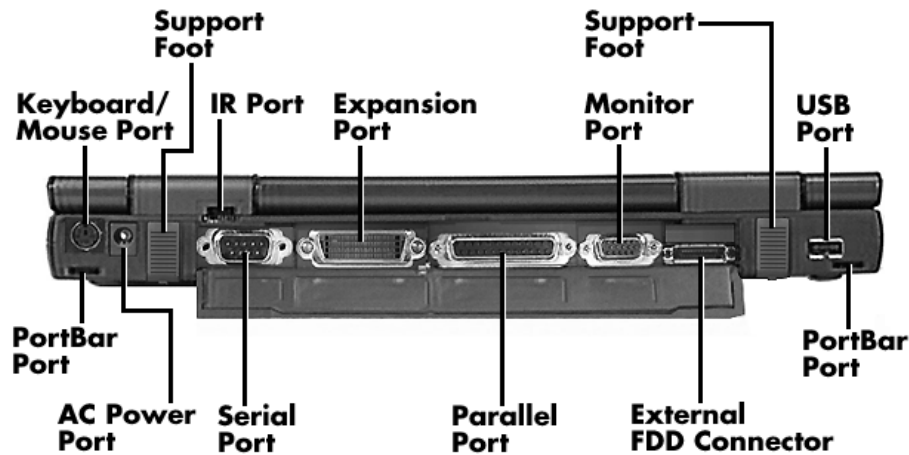

Figure 2-2 Power and I/O Connector Locations

Table 2-1 I/O Connector Descriptions

I/O Connector	Function
Keyboard/Mouse Port	Connects to a PS/2-style mouse, or a 101-key, external PS/2-style keyboard.
IR Port	Exchanges data via infrared technology
Expansion Port	Provides a 120-pin connector to attach the optional PortBar 5000.
Monitor Port	Connects to a 15-pin external CRT.
USB Port	Provides a 4-pin connector to attach to a USB device.
AC Power Port	Connects to a DC power source.
Serial Port	Provides a 9-pin connector to attach to an RS-232C device.
Parallel Port	Connects to a 25-pin parallel device.
External FDD Connector	Connects to an external diskette drive.

POWER SOURCES

The NEC Versa can be powered using three different sources, as follows:

- the AC adapter connected to an electrical wall outlet (using AC power)
- the battery pack
- an optional DC adapter connected.

The following sections summarize the power sources.

Using the AC Adapter

Use the AC adapter and power cable that came with the NEC Versa to run the computer on alternating current (AC) power, or to recharge the battery pack. Use the AC adapter whenever a wall outlet is nearby.

WARNING

Do not attempt to disassemble the AC adapter. The AC adapter has no user-replaceable or serviceable parts inside. Dangerous voltage in the AC adapter can cause serious personal injury or death. The AC adapter is intended for use only with a NEC Versa 5000 Series computer. Both must meet EN60950 standards.

Keep the adapter connected whenever possible. The AC adapter charges the battery whether or not you are using the NEC Versa.



Figure 2-3 *NEC Versa AC Adapter*

See the “Hardware Setup” earlier in this section for steps on connecting the AC adapter.

Using the Main Battery Pack

The NEC Versa comes with a rechargeable Lithium Ion (Li-Ion) battery pack. Battery power lasts for approximately one and half to three hours with power management features enabled. The battery pack is easy to install and remove.

Checking Battery Power Levels

Your NEC Versa 5000 Series system provides two tools to help you keep track of the main battery's power level:

- Battery Gauge utility, which lets you quickly identify how much battery power you have available.
- Windows 95 Battery Gauge, which lets you quickly identify how much battery power you have available.

When remaining battery power falls to 10%, the system emits a single beep; when battery power falls to about 5%, the system beeps once every 60 seconds. When 3% battery power remains Save to File automatically initializes.

What to Do When Battery Power Gets Low

When battery power is very low, the power LED flashes amber. When battery power gets low, do either of the following:

- Press the **Fn-Esc** keys simultaneously to put the system in Suspend mode, remove the battery pack, and replace it with a fully charged Li-Ion battery.
- Leave the battery pack in the system and connect your NEC Versa to the AC adapter and a wall outlet. If you connect the system to AC power and continue to use it, the battery recharges in approximately 3 hours. If you connect the system to AC power and do not use it, the battery recharges in about 3 hours.

Customers can also buy an optional NEC Versa battery charger to quickly charge the battery. See the online *Versa Tools Catalog* for more information.

When to Change the Battery

The following symptoms indicate that battery life is nearing an end. Replace batteries that display these symptoms.

- Shorter work times.
 - Discoloration, warping.
 - Hot to the touch.
 - Strange odor.
-

Battery Handling

Keep the following in mind when removing or replacing a battery.

- Use Li-Ion batteries only in the NEC Versa computer for which they are designed.
- Turn off power to the system after use. Keeping system power on can degrade battery performance and shorten battery life.
- Clean the battery terminals with a dry cloth when they get dirty.
- Keep the battery out of the reach of children.

WARNING

There is a danger of explosion if the battery is incorrectly replaced. Replace only with the same or equivalent type recommended by the manufacturer. Discard used batteries according to the manufacturer's instructions.

- Keep the battery away from heat sources including direct sunlight, open fires, microwave ovens, and high-voltage containers. Temperatures over 60°C (140°F) may cause damage.
- Do not drop or impact the battery.
- Do not disassemble the battery.
- Do not solder the battery.
- Do not puncture the battery.
- Do not use a battery that appears damaged or deformed, has any rust on its casing, is discolored, overheats, or emits a foul odor.
- Keep the battery dry and away from water.
- Keep metal objects away from battery terminals. Metal objects in contact with the terminals can cause a short circuit and damage.
- If the battery leaks onto skin or clothing, wash the area immediately. Battery fluid can cause a skin rash and damage fabric.
- If battery fluid gets in eyes, DO NOT rub; rinse with clear water immediately and see a doctor.
- Make sure the battery is properly installed in the battery bay.

Replacing the Battery Pack

Replace the battery pack installed in your NEC Versa system as follows.



Use Li-Ion batteries in the NEC Versa computer for which they are designed.

1. Close the LCD panel and turn the system upside down. Locate the battery bay latches on the bottom of the system.

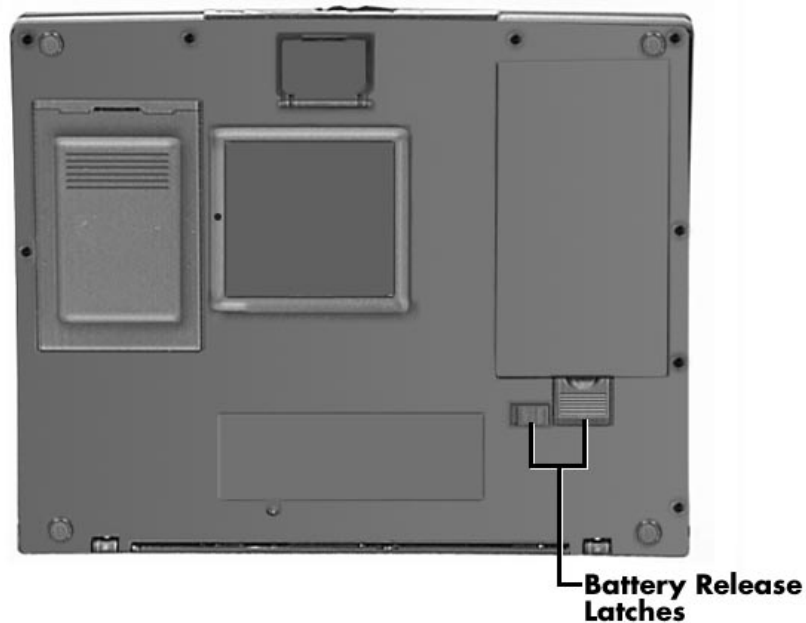

Figure 2-4 Battery Release latches

2. Press the small battery bay latch towards the middle of the system to unlock the other latch.
3. Press the other battery bay latch away from the battery.

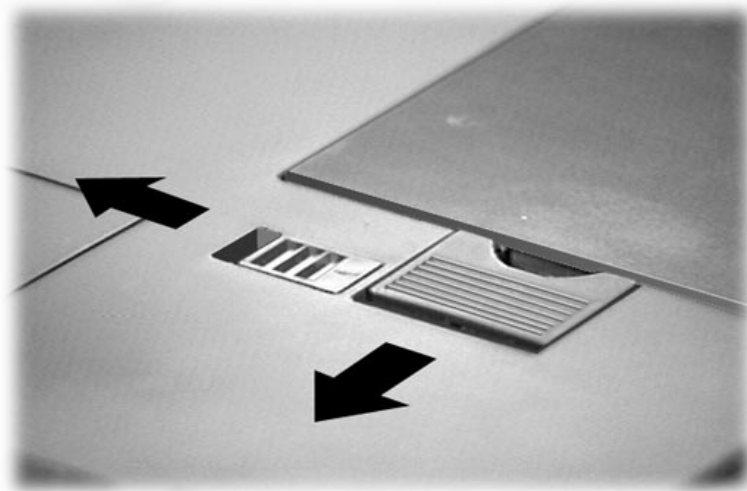

Figure 2-5 *Sliding the battery release latches*

4. Lift up the end of the installed battery pack closest to the latches.
5. Pull the battery away from the bay and lift it out.

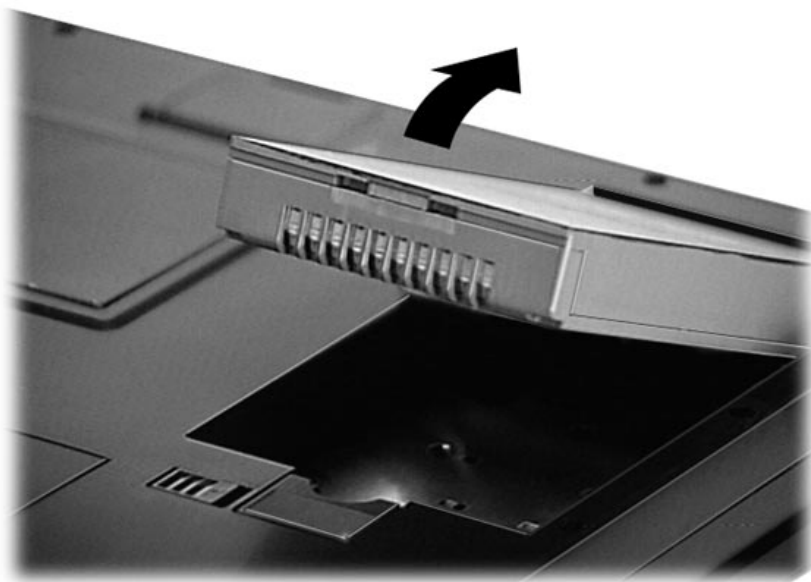

Figure 2-6 *Removing the battery pack*

6. To install the charged battery pack, lower the end of the battery pack without connectors into the bay.

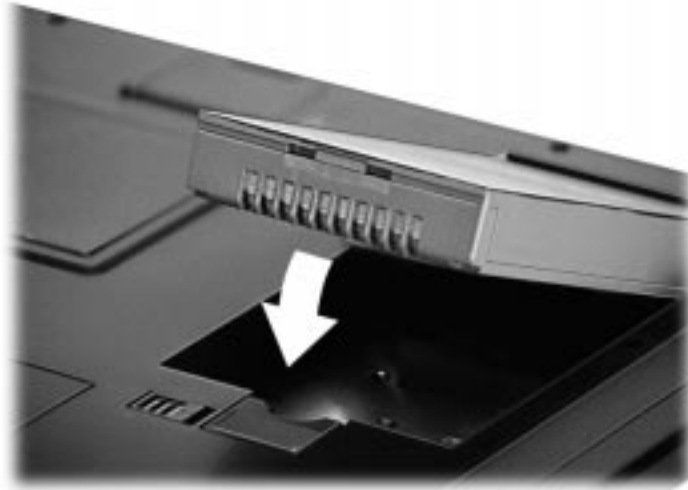

Figure 2-7 *Installing the battery pack*

7. Make sure the battery contacts are aligned properly with the connector inside the bay and press down on the battery pack to secure the connection.

The large battery bay latch snaps into place.

8. Slide the smaller latch towards the side of the unit to lock the large battery bay latch.

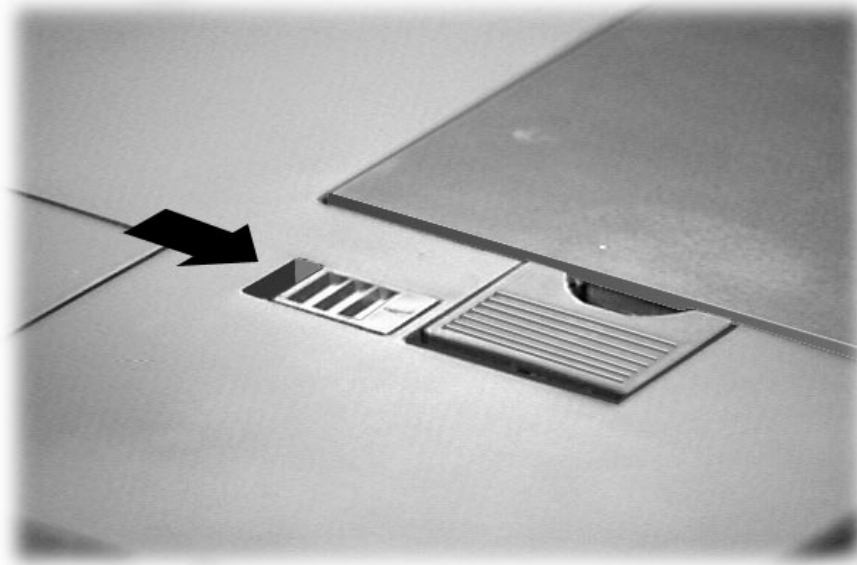

Figure 2-8 Replacing the latch

Battery Precautions

To prevent accidental battery ignition, rupture, or explosion, adhere to the following:



To avoid personal injury and property damage, read these battery precautions on handling, charging, and disposing of Li-Ion batteries.

- Keep the battery away from heat sources including direct sunlight, open fires, microwave ovens, and high-voltage containers. Temperatures over 140° F (60°C) may cause damage.
 - Do not drop or impact the battery.
 - Do not disassemble the battery.
 - Do not solder the battery.
 - Do not puncture the battery.
 - Do not use a battery that appears damaged or deformed, has any rust on its casing, is discolored, overheats, or emits a foul odor.
 - Keep the battery dry and away from water.
-

- Keep metal objects away from battery terminals. Metal objects in contact with the terminals can cause a short circuit and damage.

If the battery leaks:

- If the battery leaks onto skin or clothing, wash the area immediately with clean water. Battery fluid can cause a skin rash and damage fabric.
- If battery fluid gets into eyes, DO NOT rub; rinse with clear water immediately and consult a doctor.
- Take extra precautions to keep a leaking battery away from fire. There is a danger of ignition or explosion.

Recharging Battery Precautions

Adhere to the following precautions when recharging the Li-Ion battery.

- Read the instructions that came with the battery charger before charging the battery.
- Use only the NEC battery charger designed for your NEC Versa battery type. Different NEC Versa models require different batteries and battery chargers.
- Charge the battery for the specified charge time only.
- During charging, keep the environmental temperature between 32°F and 104°F (0°C to 40°C).

Extending Battery Life

While on the road, it is important to be aware of the simple things you can do to extend the life of the system's main battery. One way is to keep the LCD backlight setting at the lowest. You can toggle between these four settings by pressing the function keys, **Fn - F5**.

OPERATING CONTROLS

The following section describes system controls, the LEDs, and function keys.

Power Button and Status LEDs

Your NEC Versa provides a Power button and LEDs to track system status. Descriptions of these features follow the figure.

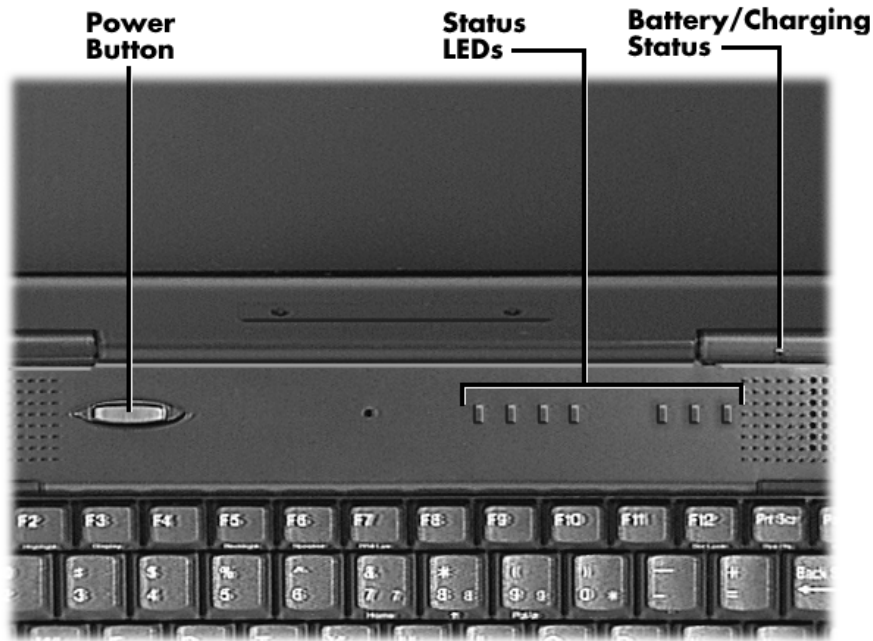

Figure 2-9 Power button and Status LED location

- **Power Button** — The Power button is located on the chassis just below the LCD. It turns NEC Versa 5000 power on and off. Press the button to turn power on; press it again to turn power off.

When power is on, the Power LED to the right of the Power button lights. (The Power LED is the left-most LED in the row of LEDs.) See “Setup Parameters” in later in this section for information about defining this button as a Suspend/Resume button.

If your system is in Suspend mode or has gone into Save to Disk mode, pressing the Power button puts the system in Operation mode.



After turning off the system, wait 5 seconds before turning it back on. This gives system components a chance to power down properly.



The Battery/Charging Status LED is located on the right-hand LCD hinge and lights to indicate the following:

- Green – the battery is fully charged and the system is connected to AC power.
- Amber – the battery is recharging.
- Off – the AC adapter is disconnected or the battery is not installed.

- A bank of status LEDs is located on the chassis at the top of the keyboard to the right of the Power button. These LEDs are identified by icons and include the following (described from left to right):







- The Power LED lights in the following sequence to indicate system operation status.
 - lights green when running on AC power.
 - blinks green when the system is in Suspend mode.
 - lights amber when running on battery power with a charged battery.

The Power LED also warns you about a low battery state. The system emits a beep and the Power LED behaves as follows:

- blinks amber when battery power is low.
- flashes amber when battery power is extremely low.

The Power LED remains unlit under the following conditions:

- if the system is not connected to AC power and the battery is not charged or installed.
- the system is not powered on.
- the system is in Save to Disk mode.

-  — Hard Disk Drive – Lights when the NEC Versa 5000 writes data to or retrieves data from the hard disk drive.
-  — CD-ROM Reader – Lights when data is read from a compact disc in the CD-ROM drive.
-  — Diskette Drive – Lights when data is written to or retrieved from the 3.5-inch diskette drive.
- A** — Caps Lock – Lights when Caps Lock is on.
- 1** — Num Lock – Lights when Num Lock mode is active.
-  — Scroll Lock – Lights when the Scroll Lock is on.

Function Keys (Fn Keys)

Function keys set specific system parameters and are built into the ROM. When using these keys, simultaneously press **Fn** and the corresponding function key. See Table 2-3 for a list of ROM-based hot keys. ROM-based hot keys change system parameters temporarily. Hot Key functions operate until the system is turned off or reset.

Table 2-3 Function Keys

Key Combination	Function
Fn-Esc	Initiates Suspend mode.
Fn- Power Button	Initiates a Suspend to Disk.
Fn-F2	Toggles character highlighting on and off (DOS display only).
Fn-F3	Toggles the display between three video modes, LCD, CRT, or simultaneous display on both.
Fn-F5	Adjusts the LCD panel brightness.
Fn-F6	Sets the internal system speaker volume to on or off.
Fn-F7	Toggles between various power management levels (Off, Custom, Highest Performance, and Longest Life.)
Fn-F12	Sets Scroll Lock on or off.
NumLock	Toggles Num Lock on and off activating and deactivating the embedded numeric keypad.
Fn-LeftCtrl	Simulates the right Ctrl key.

- Other key combinations — the following key combinations are available with some applications:

Fn-Prt Scr — sends a system request (SysReq) used in some terminal emulation applications.

Fn-Pause — sends a break (Break) command in some applications.

- Windows 95 keys — You can use the following two key combinations to facilitate your work:



— Shortcut/Application key – provides quick access to shortcut menus. (This key acts like a right mouse button.)

— Floating Window key – displays the Start menu.



- Cursor Control keys — Cursor control keys let you position the cursor on the screen where you want. On the screen, the cursor is a blinking underline, block, or vertical bar depending on the application. The cursor indicates where the next typed character will be inserted.
- Typewriter keys — The typewriter keys (also called alphanumeric keys) are used to enter text. Keys with blue printing on them behave differently when combined with **Fn**.
- Numeric Keypad — Pressing **NumLock** on the keyboard activates the numeric keypad numbers and functions printed in blue on top of these keys.

The keypad lets you type numbers, a decimal point and mathematical operands (+, -, *, /) as you would on a calculator. The keypad is ideal for entering long lists of numbers.

To use the numeric keypad, press **NumLock**. When you press **NumLock** again, the keys revert to their normal functions as typewriter keys.

Holding the **Fn** key down while pressing cursor control keys on the numeric keypad makes the keys function as control keys.

- Control keys — **Ctrl**, **Alt**, **Fn**, and **Shift** are controls used in conjunction with other keys to change their functions. To use control keys, press and hold the control key while pressing another key. For example, “press **Ctrl c**” means to hold down the **Ctrl** key and type the letter **c**. How the key combination works depends on the applications you are running.

Smart Power Switch

The Smart Power switch provides an automatic feature that prevents you from accidentally powering off the NEC Versa, and losing your data while your system is in Suspend mode. The Smart Power switch senses that the system is in Suspend mode and prevents you from directly powering off the system when you press the Power button.

To power off the system from Suspend mode,

1. press the Suspend/Resume button to make the system active.
2. press the Power button to turn off the system.

POWER-ON SELF-TEST (POST)

Each time the system is powered on, the system checks the working status of components through an automatic power-on self-test (POST). The test checks the system configuration for any discrepancies. One beep means that POST is successful. If any problems in data transfer or hardware exist, an error message appears.

If the message is an Invalid Configuration message, press **F2** to enter the Setup utility. The system collects Setup data and lists the changes detected in the current parameter settings, that can be seen in Standard CMOS Setup. Press **Enter** to review the settings, and make any necessary corrections.

If no error messages appear but the system still malfunctions, check the items in the list below.

- The Power button for each peripheral is on.
- All cables and power cords are tightly connected.
- The electrical outlet is working.
- All options have been properly installed.



If the system parameters (date, time, options, etc.) have not been entered for the present configuration, enter them when you complete the setup procedures (see “System Parameters” in this section).

POST Errors

Error messages will appear during POST when configuration information does not match the settings stored in memory. Error messages will also appear if the system loses the configuration information due to hardware failure.

Refer to Table 2-4 for a description of POST error messages.

Table 2-4 POST Error Messages

Message	What To Do
Invalid system disk	Replace the disk and then press any key.
Diskette boot failure	Insert a bootable disk in drive A and press any other key.
Non-system disk or disk error; Replace and press any key when ready	Remove the diskette from drive A and press any key to start the system from the hard disk. Or, insert a bootable disk in drive A and press any key.
Operating System Not Found or C: drive failure	Press F2 to start Setup. Change the hard disk type to the correct setting. Exit and save Setup changes.
Invalid configuration information – run Setup program	One or more system configuration parameters are not properly set. Start Setup, set them correctly, and exit and save to update the parameters.
Real time clock failure	Set time and date using Setup. Exit and save to update the parameters.
CMOS date and time not set	Set the time and date using Setup. Exit and save Setup changes to update the parameters.
System CMOS Checksum failure – run Setup Press (F1) to resume.	Press F2 to enter Setup. Under Exit, set the default values. Under Main, set the date and time. Save your changes and exit.
Fixed disk configuration error	Start Setup. Exit and save to update the parameters. Check to see if the hard disk connector is seated properly. If there is still a problem, the hard disk might need repair.
C: drive error or failure	Press F2 to start Setup. Exit and save to update the parameters. Check to see if the hard disk connector is seated properly. If there is still a problem, the hard disk might need repair.

Hard Disk controller failure	<p>Press F2 to start Setup. Exit and save to update the parameters.</p> <p>Check to see if the hard disk connector is seated properly.</p> <p>The hard disk controller does not work and might need repair.</p>
Keyboard controller failure	<p>Unplug external keyboard if attached and reboot the system. If it still fails, have the system repaired.</p> <p> Repeated keystrokes during boot may produce an error message.</p>
Keyboard Error	<p>A timing problem exists with the keyboard. If the error message remains, the keyboard may have to be repaired.</p>
KB\interface error	<p>Error exists in keyboard connector. If the error message remains, the keyboard may have to be repaired.</p>

 If a display related error occurs it is indicated by beeps. Display related errors usually require a system board replacement.

SETUP UTILITY

The Setup utility is a ROM-based program. It is functional when enabled (factory default). Setup automatically detects current system parameters during the power-on self-test (POST), described in the previous section. It also provides the following functions:

- sets date and time
 - signals any hardware discrepancies during POST via error messages
 - verifies that any optional memory that you installed was installed correctly
 - integrates user defined security features.
-

Accessing Setup

To access Setup, press **F2** at the power-on prompt.

With an Error at POST

You will need to use the Setup utility if the system detects an error during POST, it prompts you with double beep sound and a message: "Press <F1> to Run SETUP."

With No Errors at POST

To enter Setup when no error message is displayed during POST, press **F2** when the prompt appears.

Setup Utility Main Menu

After you press **F2**, the system displays the Setup Main Menu screen, similar to the following.

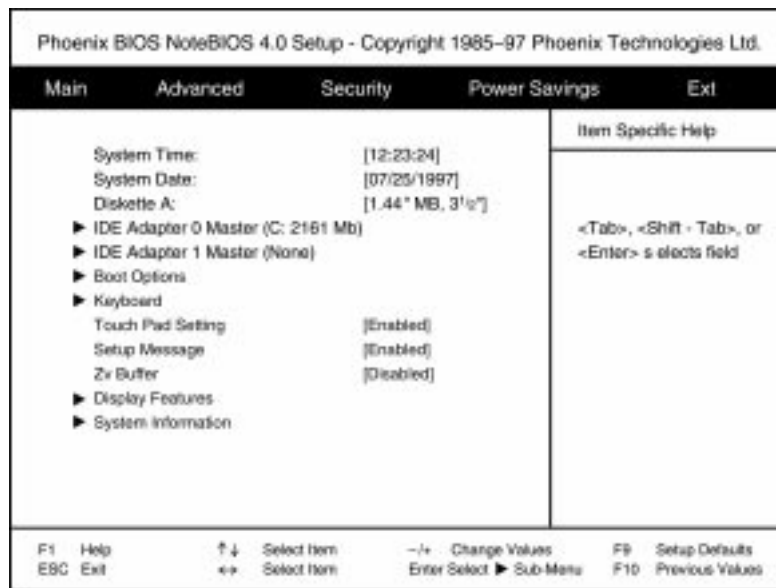

Figure 2-10 Setup Main Menu

Use the up and down arrow keys (located on the lower right corner of the keyboard) to toggle through the Setup menu items.

How to Use Setup

The following sections describe how to use Setup, including these topics:

- Looking at screens

- Using keys
- Checking and setting system parameters.

Looking at Screens

Setup screens have three areas as described next.

- Parameters
The left part of the screen. This area lists parameters and their current settings.
- Item Specific Help
The right part of the screen. This area lists alternate settings.
- Key Legend
The bottom of the screen. These lines display the keys that move the cursor and select parameters.

Using Keys

The following table lists Setup keys and their functions.

Table 2-5 Setup Key Functions

Key	What It Does
F1	Accesses the BIOS help program to answer any questions that you may have about using Setup.
Esc	Closes the current window or drop-down screen, de-activates the menu bar, or closes the Setup utility.
↑ ↓	Moves the cursor up or down among the parameters on a drop-down menu.
← →	Scrolls, left or right, along the menu bar and highlights the current menu selection.
-/+	Allows you to change values or toggle through the available settings for the highlighted parameter.
Enter	Opens the currently highlighted menu or parameter item. After highlighting a selection with the menu triangle next to it, press Enter to display the settings available for the option.
F9	Resets all system parameters on the current drop-down screen to their original default settings.
F10	Resets a field to its previous value.
Home/End	Moves to the first/last parameter of the currently open drop-down screen.
Tab	For some settings, moves the cursor between the subfields. For example, for Startup / Date and Time, Tab moves the cursor from day to month to year to hour to minute to second.

Checking/Setting System Parameters

See the following table for a list of parameters, their factory default settings, and alternate settings. As you set each parameter, the Item-Specific Help describes the feature that it controls.

To reset all system parameters to their factory default settings, select Default Values on the Exit screen.

Table 2-6 Setup Parameters

Menu and Parameter	Default Setting	Other Settings Available
Main		
System Time	HR:MIN:SEC	
System Date	MO/DAY/YEAR	
Diskette A	1.44 MB, 3 ½"	None
IDE Adapter 0 Master Autotype Fixed Disk Type	C: 2161 Mb Press Enter [Auto]	CD, None, 1 through 14, Rsrv, 16 through 39, User
Cylinders		
Heads		
Sectors/Track		
Write Precomp		
Multi-Sector		
Transfers	Enabled	Disabled, 2, 4, 8 Sectors
LBA Mode Control	Enabled	Disabled
32 Bit I/O	Enabled	Disabled
Transfer Mode	Fast PIO 4	Standard Fast PIO 1 Fast PIO 2 Fast PIO 3
IDE Adapter 1 Master Autotype Fixed Disk Type	None Press Enter Auto	CD, None, 1 through 14, Rsrv, 16 through 39, User
Cylinders		
Heads		
Sectors/Track		
Write Precomp		
Multi-Sector		
Transfers	16 Sectors	Disabled, 2, 4, 8 Sectors
LBA Mode Control	Enabled	Disabled
32 Bit I/O	Enabled	Disabled
Transfer Mode	Standard	Fast PIO 1 Fast PIO 2 Fast PIO 3 Fast PIO 4

Boot Options		
POST Errors	Enabled	Disabled
Boot sequence	1. CD-ROM Drive 2. Diskette Drive 3. Hard Drive	
Floppy check	Enabled	Disabled
Summary screen	Enabled	Disabled
Keyboard		
Numlock	Off	On
Key Click	Disabled	Enabled
Keyboard auto-repeat rate	30/sec	26.7/sec, 21.8/sec, 18.5/sec, 13.3/sec, 10/sec, 6/sec, 2/sec
Keyboard auto-repeat delay	1/2 sec	3/4 sec, 1 sec, 1/4 sec
Touch Pad Setting	Enabled	Disable w/ PS/2 Mouse
Setup Message	Enabled	Disabled
Zv Buffer	Disabled	Enabled
USB Controller	Disabled	Enabled
Display Features		
Display Device	LCD	CRT; Simultaneous
Text Mode		
Expansion	Disable	Enable
Graphic Mode Expansion	Disable	Enable
System Information		
Phoenix Version	PxxxH	
OEM Version	Vxxx	
Keyboard Version	Hxxx	
Total Memory Size	currently installed memory	
CPU	Pentium with MMX [166MHz]	
Cache Ram	256 Kb	CD-ROM
Multiple Drive Bay	currently installed device	Disable
Parallel Port FDD	Enable	Disable
Battery Remaining	xxx%	
Keyboard	USA	Japanese, Europe

Advanced		
Integrated Peripherals		
COM/LPT setting	Auto	Manual
COM Port A	3F8, IRQ 4	Auto, Disabled 2F8, IRQ 3 3E8, IRQ 4 2E8, IRQ 3
COM Port B	2F8, IRQ 3	Auto, Disabled 3F8, IRQ 4 3E8, IRQ 4 2E8, IRQ 3
COM Port B Device	Fast IR	IrDA
Fast IR DMA CH	0	1, 3, None
LPT Port	378, IRQ 7	Auto, Disabled 378, IRQ 5 3BC, IRQ 7 278, IRQ 5
LPT Mode	ECP	Output Only Bi-Directional
ECP DMA CH*	None	0, 1, 3
Diskette controller	Enabled	Disabled
Local Bus IDE	Enabled	Disabled
adapter		
Audio Setting	Auto	Manual
Audio I/O Address	220	240, 260, 280, Disabled
Audio FM Address	388	390, 398, Disabled, 380
MIDI Port Address	330	Disabled, 300, 310, 320
Audio IRQ Number	5	7, 9, 10, 11, 12, None
Audio DMA Channel	1 3	0 1, 0 3, 1 0, 3 1, 3 0, None
Plug & Play O/S	Yes	No
Large Disk Access Mode	DOS	Other
Security		
Supervisor Password is	Disabled	Enabled
User Password is	Disabled	Enabled
Set Supervisor Password	Press Enter	Enter new password Re-enter new password
Set User Password	Press Enter	Enter new password Re-enter new password
Password on boot	Disabled	Enabled
Power Savings		
Power Switch	On/Off	Suspend/Resume
Lid Switch	Suspend	Backlight Off

Low Battery Beep	Enabled	Disabled
Power Management	Battery Only	Always
Power Savings	Longest Life	Off, Customize, Maximum Performance
Idle Mode	On	Off
Standby Timeout	4 Minutes	1, 2, 6, 8, 12, 16 Minutes, Off
Auto Suspend Timeout	10 Minutes	5, 15, 20, 30 Minutes, Off
Hard Disk Timeout	2 Minutes	10, 15, 30, 45 Seconds 1, 4, 6, 8, 10, 15 Minutes Off
Video Timeout	2 Minutes	10, 15, 30, 45 Seconds 1, 4, 6, 8, 10, 15 Minutes, Off
CD-ROM Timeout	45 Seconds	10, 15, 30 Seconds 1, 2, 4, 6, 8, 10, 15, Minutes, Off
Suspend Mode	Suspend	Save To Disk
Wake up from suspend	Off	On
Resume Alarm Time	HR:MIN:SEC	
Exit		
Discard Changes & Exit		
Save Changes & Exit		
Get Default Values		
Load Previous Values		
Save Changes		

*Available when COM Port B Device is set to IrDA.

Setup Menus

Read the following descriptions for an explanation of each item that appears in the Setup menus, as listed in the preceding table.

Main

Use the Main Setup screen to check or modify your basic system settings. Some fields are read-only fields that simply display current information.

- Time and Date — let you adjust your system date and time.
- Diskette A — displays the diskette drive type installed in your system.
- IDE Adapter 0 Master and IDE Adapter 1 Master — shows your current hard disk capacity. Submenus to these two fields let you specify another drive type, define multi-sector transfer rates, specify LBA mode control, enable or disable 32-bit I/O, and define transfer mode.
- Boot sequence — allows you to specify if POST error messages appear at boot up, what the boot sequence should be, and whether or not the system checks your diskette drive type. (Disabling the floppy check speeds up boot time.)
- Keyboard — lets you specify the country keyboard to use, define if NumLock is on or off at boot up, enable keyclick, and define auto-repeat and delay rates.
- Touchpad settings — allows you to disable the built in touchpad when attaching an external PS/2-style mouse.
- Display features — gives you the chance to define your display type, the text expansion mode, and the graphics expansion mode for better viewing.
- System information — displays information about your system, including the version of BIOS loaded, total RAM installed, CPU type, Cache RAM, parallel port status, and amount of battery charge remaining.

Advanced

Advanced lets you define specific input/output addresses, audio settings, and channel numbers. Only change the settings in this section if you are very familiar with the way that a system uses its resources. Making incorrect setting decision in this menu can cause your system to malfunction.

 **CAUTION**

Setting incorrect values in the Advanced portion of the Setup utility can result in a system malfunction.

- Integrated peripherals — lets you disable, enable, or manually change COM port and LPT port address and mode. You can also define the audio I/O address, MIDI port address, audio IRQ number and DMA channel.
- Plug & Play OS — displays whether the operating system on your NEC Versa is plug-and-play operating system.
- Large Disk Access Mode — allows you to specify the large disk access mode to use.

Security

Your NEC Versa 5000 supports a password for system security. Using the Security screen, you can require that a password be entered at each startup or boot.

You are not prompted to enter a password until you set an initial password. Your system is not protected until you set a password.



If Supervisor and User passwords are both implemented, the user level cannot access the diskette drive.

Once you set a password, you must enter it before your system will boot up. This feature allows only an authorized user to access your system, including the Setup program where you can set or change system parameters.

Set an initial password as follows.

1. Select Security from the menu bar.
2. Open the Set Supervisor Password screen by pressing **Enter**.
3. In the “Enter New Password” field, enter a password up to eight characters long. Press **Enter** on the keyboard.
4. Reenter your password as prompted for verification. Press **Enter** and write your password down and keep it in a secure place in case you forget it.

A dialog box notifies you that changes have been saved. Press **Enter** to continue. The “Supervisor Password is” field changes to Enabled. This password keeps anyone without the password from making changes in Setup.

5. Continue to the next field, Set User Password, to enter a user password. Enter the password twice.

A dialog box notifies you that changes have been saved. Press **Enter** to continue. The “User Password is” field changes to Enabled.

6. In the final field on the screen, enable the password on boot to prevent unauthorized access to the system. The user must then enter the User Password to gain access to the system.

Remove a previously set password as follows.

1. Enter Setup using the previously set password.
2. In the Security menu, highlight Set Supervisor Password and press **Enter**.
3. In each password field, press **Enter**. The dialog box stating that changes were saved appears. Press **Enter** again.

The password is no longer enabled.

If you forget your password, proceed as follows.

1. With system power on, carefully tilt the system on its side. Using a straightened paper clip or other pointed object, press in the Password Override Switch on the bottom of the system.



Figure 2-11 Password Override Switch

2. Reboot and enter Setup. You may receive a Checksum error message.
 3. Go to the Exit screen and select Get Default Values.
 4. Press **Enter**. A dialog box informs you that the default values have been loaded.
-

5. Press **Enter** to continue. Select Save Changes & Exit. Press **Enter** twice.

Power Savings

The Power Savings screen lets you balance system performance and energy conservation, for both battery and AC operation, using the following parameters.



Some operating systems have their own power management software which overrides the settings in Setup. In this case, be sure to set your desired power management settings accordingly in the operating system.

- **Power Switch** – lets you assign your Power button as either an on/off switch or a Suspend/Resume switch.
 - **Lid Switch** – allows you to specify how the system reacts when the LCD panel is closed. You can choose between having the LCD panel backlight go off or having the system go into Suspend mode.
 - **Low Battery Beep** – gives you the option of disabling the low battery warning beep.
 - **Power Management** – specifies if power management is enabled at all times or only when using battery power.
 - **Power Savings** – specifies the type of power management to enable. You can choose from the following:
 - **Longest Life (default)**
Sets power savings to a maximum and system performance to a minimum, by running the CPU at half speed all of the time.
 - **Maximum Performance**
Sets system performance to a maximum and power savings to a minimum, by running the CPU at full speed all the time.
 - **Customize**
Lets you input your choice of performance and power saving parameters. See “Using Power Management,” later in this chapter, for details.
 - **Off** – lets you turn off power management completely.
 - **Suspend Mode** – lets you select the type of Suspend mode that your system uses. Suspend saves the current system state while remaining in a low power mode. Save to Disk saves the current system state to a special file and then shuts down the system.
-

- Wake up from suspend – lets you enable your system to resume from suspend in the time specified by Resume Alarm Time.
- Resume Alarm Time – lets you specify the time when the system awakes from Suspend mode.

Exit

Lets you save or not save parameter changes when you exit Setup, as follows:

- Discard Changes & Exit
Exits Setup, without saving changes.
- Save Changes & Exit
Saves changes and restarts the system, so parameter settings take effect immediately.
- Get Default Values
Restores all Parameter settings to their default settings. Default settings take effect on the next system startup.
- Load Previous Values
Reload all the parameter values from the previous Setup settings.
- Save Changes
Save all Setup changes.

Using Power Management

Power Management in the NEC Versa 5000 lets you conserve energy, save battery power, extend the life of your LCD backlight, and protect against data loss due to low battery power.

You can set some features to function automatically or activate them manually with the keyboard or a button.

Power Saving Modes

The NEC Versa 5000 has three different power consumption states. These include:

- Active Mode – All components are turned on and active.



Even in Active Mode, you can specify time-outs for the LCD panel, hard disk drive and CPU. See “Power Management Settings.”

- Standby Mode – Eliminates unnecessary battery or AC power consumption. The LCD panel, Hard Disk Drive and CD-ROM reader all shut down, and the Keyboard Controller and CPU slow down, providing both privacy and power savings.

To end Standby mode, press any key and return to Active mode.

- Suspend Mode – Shuts down every system component, except those that preserve unsaved data in memory, or system status and PC cards if so configured.

To end Suspend mode and return to Active mode, press the Power button beneath the LCD panel and resume the system.

You can set your system to enter Standby or Suspend modes automatically after a specified number of minutes of system inactivity. System activity includes keyboard, VersaGlide, diskette or hard disk drive access, PC card modem, network, or LAN card, serial, or printer port communications.

Power Management Settings

The system arrives set up with many power-saving features already enabled. You can change the timeout period for these devices in Setup, under the “Power Savings” menu, with the “Power Savings” set to Customize. The following table lists the default settings for “Longest Life” mode, the default setting.

Table 2-7 Automatic Power-Saving Features

Device	Default Timeout	Comment
Idle Mode	On	Idle mode slows down the CPU during brief periods when the system is not busy.
Standby Timeout	2 minutes	Specifies how long the system is in Idle mode before entering Standby mode. Standby turns off various system devices including the screen.
Auto Suspend Timeout	10 minutes	This setting specifies how long the system remains in Standby mode before entering Suspend.
Hard Disk Timeout	2 minutes	Stops the hard disk motor when the hard disk is not accessed for the specified timeout.
Video Timeout	2 minutes	Shuts off video screen after the timeout specified elapses.
CD-ROM Timeout	2 minutes	Specifies how long the CD-ROM reader remains inactive before being turned off.



In Windows 95 systems, power management settings under Windows override the settings established in Setup.

Section 3

Troubleshooting

This section focuses on providing you with some information on basic troubleshooting as well as how to translate some system error messages.

QUICK TROUBLESHOOTING

This section summarizes problems that may develop during system operation and lists suggested corrective actions.

Table 3-1 Quick Troubleshooting

Problem	Corrective Actions
No power	<p>Check that the AC adapter is plugged into the power connector of the system. Also, check that the AC adapter is plugged into a properly grounded AC power outlet.</p> <p>If using the battery as the main power source, check if the battery pack is the right type, is charged, and is inserted correctly.</p> <p>Check the I/O board of the system. Is it inserted into the CPU board connector properly? Otherwise, replace the I/O board.</p>
Data on the LCD is unreadable	<p>Check LCD Panel View Expansion in BIOS, Press Fn-F8 to toggle Panel View Expansion</p> <p>Check if installed VGA driver is correct.</p> <p>Check the VGA controller chip on the I/O board for any loose soldering.</p> <p>Replace the CPU board.</p>
Battery power does not last long	<p>Make sure that the power management features are enabled.</p> <p>Recharge the battery pack for 2 hours or up to 100% before using again.</p> <p>Replace the battery pack.</p>

System halts during boot sequence	<p>Check condition of selected boot device (diskette, hard disk or CD-ROM) for bad boot track or incorrect OS files.</p> <p>Try booting from a new bootable diskette and re-copy or repartition hard disk.</p> <p>Check for any BIOS error messages on the display screen.</p> <p>Replace the CPU board or I/O board.</p>
I/O processing malfunctions	<p>Check the connections of all internal devices.</p> <p>Replace the CPU board or I/O board.</p>
Diskette drive does not work	<p>Check if diskette drive cable is connected properly.</p> <p>Check if the diskette drive works on the external FDD Connector or with the PortBar 5000.</p> <p>Check diskette type if correct and not faulty.</p> <p>Replace the diskette drive.</p> <p>Replace the I/O board.</p>
Hard disk drive malfunction	<p>Check if hard disk drive is set properly on CMOS SETUP.</p> <p>Check drive connections.</p> <p>Check if disk drive is good.</p> <p>Replace the CPU board or I/O board.</p>
Memory malfunction	<p>Check if the memory module is inserted properly.</p> <p>Replace the memory module.</p> <p>Replace the CPU board.</p>
External keyboard or PS/2 mouse doesn't work	<p>Check if keyboard or mouse are connected properly. Check Y-adapter if it is being used. Power off system first before plugging in the device.</p> <p>Replace the keyboard or mouse.</p> <p>Replace the CPU board or I/O board.</p>

PC card does not work

Check the PC card driver installation for any IRQ or I/O address conflict.

Check if the PC card is inserted properly and all connections are set.

If the PC card is a Type II card, install it in the system's other PC card slot.

Replace the PC card.

Replace the I/O board.

NEC VersaGlide doesn't work

Check if PS/2 or Alps mouse driver is properly installed.

Check VersaGlide cable inside the system if it is inserted properly.

Remove VersaGlide and clean it.

Check the keyboard controller chip for any cold or loose soldering.

Replace the CPU board.

Serial device does not work

Check if device driver is installed properly.

Check if serial device is connected properly.

Check the device drive installation for any IRQ or I/O address conflict.

Replace serial device.

Check the I/O controller chip on the main board for any cold or loose soldering.

Replace the I/O board.

Parallel device does not work

Check all connections.

Check if external device is turned on.

Check the device drive installation for any IRQ or I/O address conflict.

Test another parallel device.

Check I/O controller chip on the main board for any cold or loosed soldering.

Replace the I/O board.

HELPFUL QUESTIONS

Here are some helpful questions to ask when troubleshooting the notebook:

- Is there any external power source connected to the computer?
 - Is the battery fully charged?
 - Is the computer turned on and the Power LED activated?
 - Is the LCD display switched to the external monitor?
 - Are all cables and devices connected properly and securely?
 - Are all needed device drivers installed properly?
 - Have you checked the AUTOEXEC.BAT and CONFIG.SYS files for errors?
 - Is the Suspend Mode activated? Press any key or press the Power switch to power on the system.
-

Section 4

Field Service Guidelines

This section contains preventive and corrective maintenance procedures for the following NEC Versa 5000 Series models:

- NEC Versa 5060
- NEC Versa 5060X.

Section 4 is broken into four sections, which are presented in the following order:

- “Preventive Maintenance” describes cleaning procedures and preferred handling procedures for sensitive components (for example disk drives, batteries).
- “Disassembly and Assembly” identifies all field replaceable parts with the remainder of the section containing the removal and replacement procedures for the field replaceable parts.
- “Illustrated Parts Breakdown” contains an exploded view diagram and a listing of field-replaceable parts with part numbers.
- “Service and Product Information” lists NEC service and information telephone numbers.

PREVENTIVE MAINTENANCE

Preventive maintenance is limited to cleaning the plastic case, the keyboard, the display screen, and the diskette drive heads as required.



Remove the battery and disconnect the AC adapter before performing any maintenance. Voltage is present inside the system unit and LCD even after the system is turned off.

Cleaning the Notebook Exterior

Use the steps below to clean the outer surface of the system.

1. Power off the system and remove all battery packs. Unplug all cables connected to the system.
-

2. Wipe the outside of the system, keyboard, and display with a soft, clean cloth. Remove stains with a damp, almost dry cloth. Use glass cleaner to clean the LCD. Apply the glass cleaner directly to the cloth and then wipe the LCD. Do not use solvents or strong, abrasive cleaners on any part of the system.
3. Clean the keys with a damp cloth. A small, soft-bristle brush may be used to clean between the keys. Make sure to use a damp cloth (not wet) to prevent moisture from seeping between the keyboard and the metal plate, possibly damaging the components under the keys. If the keyboard gets wet, thoroughly dry it before re-assembling the system unit.

Cleaning the Notebook Interior

When servicing the inside of the notebook, remove dust and other foreign particles from inside the system unit as follows.

1. Remove the top cover and keyboard using the disassembly procedures discussed later in this section.
2. Dust or vacuum (with a rubber-tipped nozzle) the inside of the system, particularly the motherboard surface. Use care to avoid damaging or dislodging any components or cables.
3. Inspect all cables connectors for damage. Ensure that connectors are seated properly before replacing the cover.

Protecting the Disk Drives

To protect the disk drives and data, back up the system disk periodically on diskettes. Periodically use a head-cleaning diskette in the disk drive to prolong the life of the drive and to help maintain data integrity.

Here are some maintenance procedures to use when servicing a hard disk:

- Always back up the data files from the hard disk.
 - Run a virus detecting program to check for possible virus infected areas on the hard disk.
 - Use the preinstalled ScanDisk program to correct any errors found in the directory and File Allocation Table (FAT). This also frees up space from any unused sectors.
 - Never turn the computer off when the hard disk is being accessed.
 - Never move or raise the computer while the hard disk is being accessed. Be especially careful not to jar the hard disk during access; this can cause a hard disk crash.
-

- Use hard disk maintenance program like DEFRAG under DOS, or acquire Norton Utilities SPEEDISK programs. These programs reorganize your hard disk by eliminating fragmentation and improves the hard disk access time.

Handling the Battery Pack

The battery pack furnished with the computer require reasonable care and handling to ensure efficient operation and maximum life. Periodically inspect the battery terminals and the batteries for evidence of corrosion and oxide build-up.

To ensure that the battery pack endures for a normal life cycle, always observe the following precautions when handling the battery packs:

- Do not drop the battery packs or subject them to excessive shock and vibration.
- Do not expose the battery packs to direct sunlight, moisture, chemical compounds, or extreme heat.
- Do not disassemble the battery packs.
- Do not use the battery packs to power other devices.
- Do not short the battery leads or connect the battery with reversed polarity.
- Never attempt to charge the battery packs in any way other than as described in this manual and the user's guide.
- Always charge the battery packs as soon as possible after a low battery indication.

Maintaining the LCD Quality

When it comes to screen problems, heat plays a big part. After a good working session, the typical routine is to shut the machine and close the cover. The display surface (no matter what type it is) radiates heat. When you close the cover, you trap the heat against the screen. Make sure to leave the computer's cover open for about ten minutes while the heat disperses, before closing the LCD.

DISASSEMBLY AND REASSEMBLY

This section contains step-by-step disassembly procedures for the system. Reassembly is the reverse of disassembly. Each procedure is supported by a simplified disassembly illustration to facilitate removal. The Illustrated Parts Breakdown and parts lists for the system unit are shown later.

For complete disassembly of the system, follow the disassembly order listed in Table 4-1. To reassemble, follow the table in reverse order.

Table 4-1 NEC Versa 5000 Series Disassembly Sequence

Sequence	Part	See Page
1	Battery Pack	4-5
2	UltraSlim Versa Bay	4-5
3	Hard Disk Drive	4-8
4	Keyboard	4-10
5	LCD and Top Cover	4-10
6	Bottom Assembly	4-11
7	Top Cover Components	4-12

When disassembling the system unit, follow these general rules.

- Turn off and disconnect all power and all options, including the AC adapter (if connected) and battery packs (see the procedures that follow).
- Do not disassemble the system into parts that are smaller than those specified in the procedure.
- Label all removed connectors. Note where the connector goes and in what position it was installed.

Required Tools and Equipment

All NEC Versa corrective maintenance procedures can be performed using the following tools:

- Tweezers
 - Small flat-head screwdriver
 - Small Phillips screwdriver
 - Small Hex-bolt screwdriver
 - Rubber finger tip
 - Right-angled dentist style probe.
-

Battery Pack

Remove the battery pack installed in the NEC Versa system as follows.

1. Make sure the power is off.
2. Close the LCD and turn the system over.
3. Press the battery release latches and lift the battery out of the system.

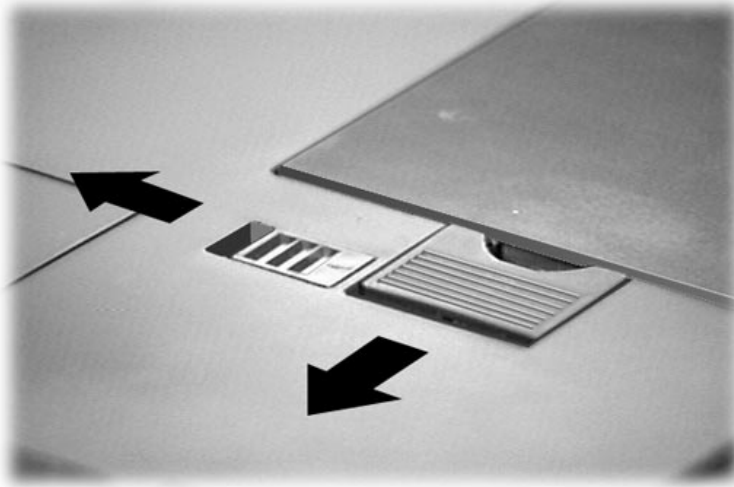

Figure 4-1 Releasing the Battery Pack

UltraSlim VersaBay

The NEC Versa 5000 comes with an UltraSlim VersaBay that lets you install the diskette drive, 20X CD-ROM reader, or Weight Saver pack in your system. Insert the Weight Saver pack into the VersaBay to decrease system weight. This is especially handy when you are traveling with your notebook computer!

Removing and installing devices in the VersaBay is easy. Follow these simple steps.

1. Make sure that any peripheral devices are disconnected from the system and that the LCD panel is closed and latched.



The Change DriveBay utility that is part of the Start menu puts your system into Suspend mode allowing you to change the option in the bay without shutting down your system completely.

2. Turn the system over and locate the VersaBay Release Lever cover.

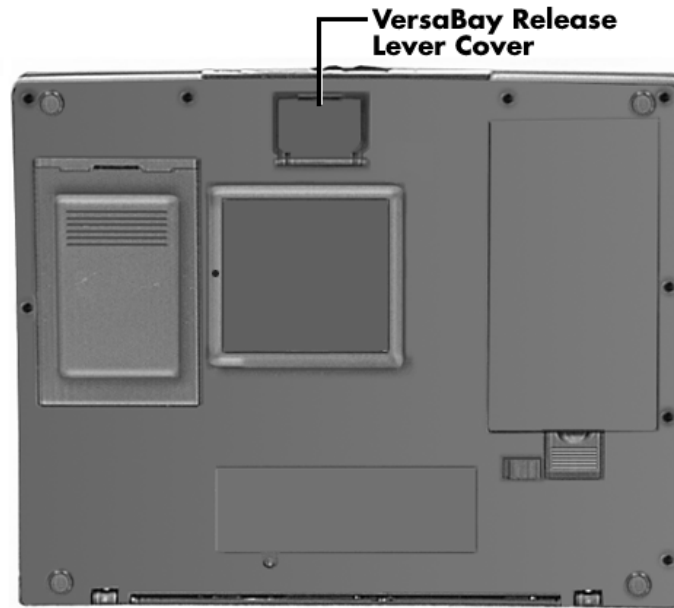

Figure 4-2 Release Lever cover

3. Open the cover. Opening the cover puts your system into a Suspend state, if it is currently powered on.



Figure 4-3 Opening the cover

4. Press the Release Lever toward the front of the system. Be sure that your fingers are not in front of the device that you are trying to remove.



Figure 4-4 *Pressing the Release Lever*

5. Pull the device installed in the VersaBay away from the system and remove it.

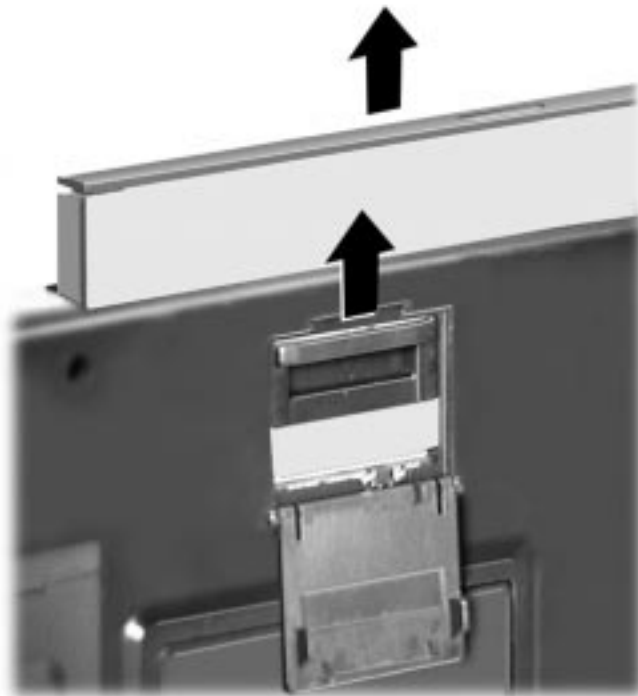



Figure 4-5 *Removing the device*

Removing the Hard Disk Drive

Make sure your NEC Versa is powered off, all external options are disconnected, and the LCD panel is closed. Then proceed as follows to replace the hard disk drive.

 The NEC Versa must be powered off while the hard drive is being removed and installed.

1. Verify that all peripheral devices and cables are disconnected from your system. Check that the LCD panel is closed and latched. Make sure the system is powered off.
2. Turn the NEC Versa over.
3. Insert the tip of a flat-head screwdriver or the edge of a coin into the groove and gently pry the drive spacer up.

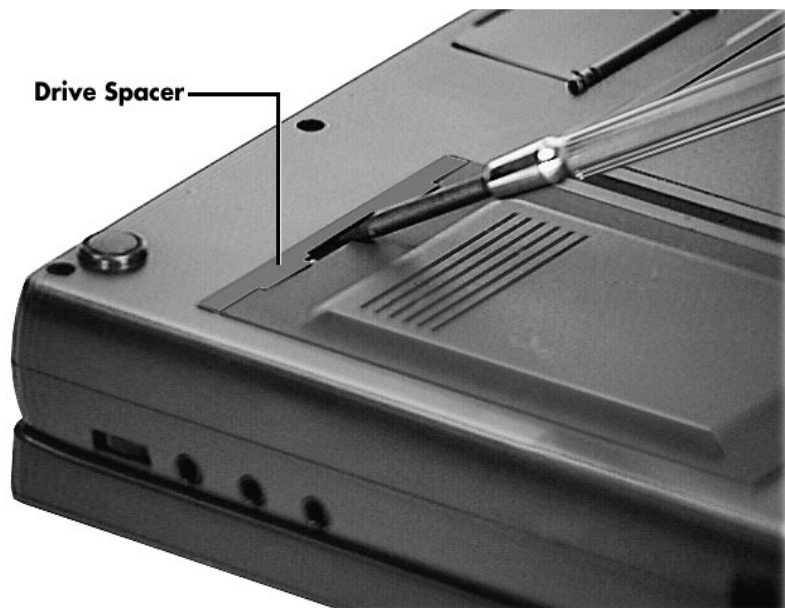

Figure 4-6 *Releasing the spacer*

4. Press down on the other end of the hard disk. Slide the drive towards the spacer to disconnect the drive from the connector.
-

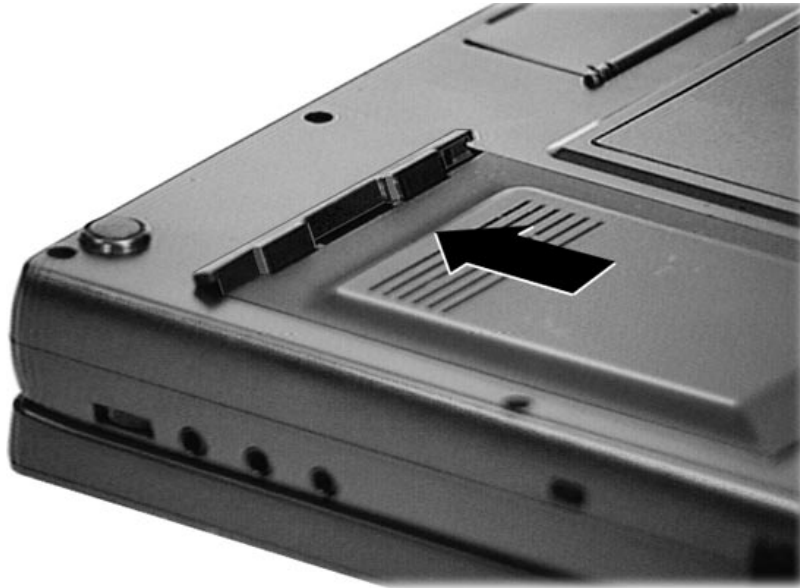

Figure 4-7 *Sliding the drive towards the spacer*



Figure 4-8 *Removing the hard drive*

5. Once you disconnect the drive connector from the system, lift the drive up by the drive spacer and lift it out of the bay.

Keyboard

Remove the keyboard from the system as follows.

1. Use a rubber fingertip to release the two screw covers. There is one cover above the **F1** and **F2** function keys and another above the **Prt Scr** and **Pause** keys.
2. Remove two screws and a retainer on each side of the top edge of the keyboard.
3. Use a screwdriver to gently lift the top edge of the keyboard up and towards the VersaGlide while spreading the keyboard frame at or near the center on each side of the keyboard.
4. Disconnect the keyboard ribbon cable at CN17 on the Main board.
5. Remove the keyboard from the system.

LCD and Top Cover Assembly

Remove the LCD by following the following instructions.

Hinge covers

Remove the two Hinge covers as follows:

1. Open the LCD cover to 90 degrees.
 2. Apply pressure to the bottom inside surface of the hinge until the hinge cover unseats. After both hinge covers are unseated open the LCD cover further and remove the hinge covers.
 3. Remove the two screws (one from each) hinge area. Disconnect the two LCD cables from CN11 and CN27 on the Main board.
 4. Close the LCD cover and turn the notebook over.
 5. Open the feet and remove two screws from under each foot.
 6. Remove 10 screws from the bottom.
 7. Turn over the notebook and open and lift the LCD from the bottom assembly carefully feeding the LCD cables through the opening in the keyboard surface.
 8. Remove one screw which is in the top center of the keyboard opening.
 9. Remove 4 screws under LCD.
 10. Remove 2 ribbon cables for sound board.
 11. Carefully feed LCD cables through opening in keyboard top cover.
-

12. Carefully separate the top and bottom subassemblies starting at the UltraSlim VersaBay opening
13. Lift off and turn over the Top Cover Assembly. Figure 4-9 show the various components on the under side of the top cover. Table 4-2 shows connector numbers and number of screws for each of the components in the top cover subassembly.

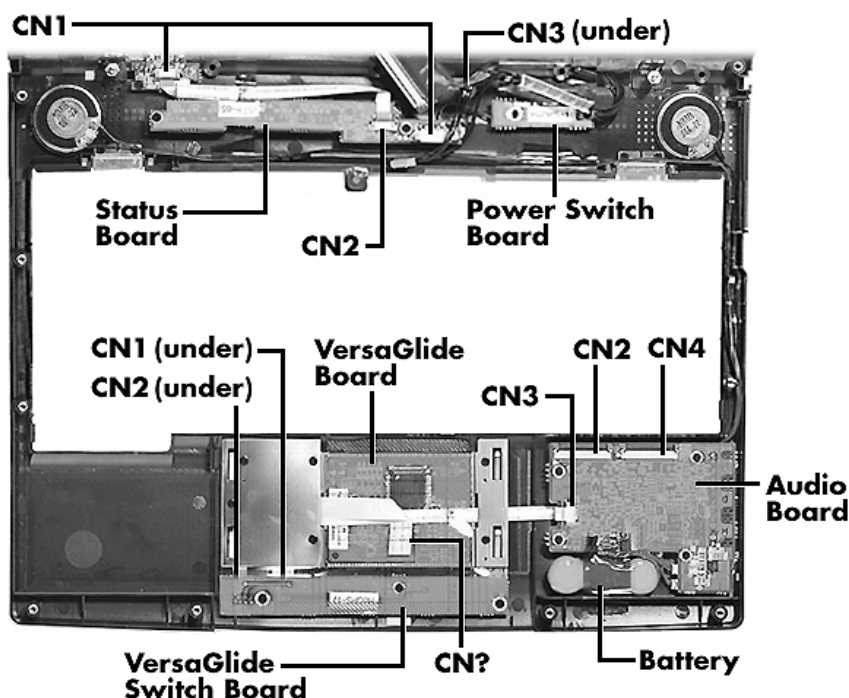

Figure 4-9 Top Cover Subassembly

Bottom Assembly

1. Remove the CPU assembly as followings
 - remove four screws
 - disconnect the fan cable from CN20 on the Main board
 - disconnect the lift the CPU assembly from the Main board
2. Remove the Power board as follows
 - Remove three screws and one stand off
 - Lift the Power board from the Main board

3. Remove the Main board as follows

- Remove four screws and two stand offs
- Disconnect cable at CN29
- Lift Main board from bottom assembly

4. Remove the VersaBay detector board as follows

- Remove two screw

Table 4-2 Top Cover Components

Component	No. of Screws	Cables Attached to Listed Boards	Cable Type	Remarks
Speakers, right	None, snap fit	CN8 on audio board	2 wires	Longer cable
IR Board	2	CN2 on LED Status board	Use ribbon cable	
LED Status Board	2	CN1 to Main board CN2 to IR board CN3 to Power Switch board		
Power Switch Board	2	CN3 on LED Status board		
Speakers, left	None, snap fit	CN9 on audio board		Short cables
Audio Board	4	1. Speaker left 2. Speaker right 3. Battery 4. HDD Assembly (2) 5. VersaGlide Switch board		
VersaGlide pad	6 and 2 retaining clips	Audio Board VersaGlide switch board		Need to remove or fold back clear insulator
VersaGlide switch board	3	Audio board CN3 VersaGlide pad CN1		Need to remove or fold back clear insulator

ILLUSTRATED PARTS BREAKDOWN

The NEC part numbers and illustrated parts breakdown (IPB) figure for the NEC Versa 5000 Series. The figure shows the system exploded view diagram, or IPB. The following table lists field-replaceable parts and corresponding part numbers.

NEC Versa 5000 Series Field-Replaceable Parts (Models 5060, 5060X, 5080 and 5080X)

Item	Part Number
1. LED Board and Chassis Assembly	3RE0B13515330
2. Bottom Base Assembly	3RE0123503250
3 Mouse Cable	3RE4W37000190
4. VersaGlide Button Switch	3RE0B13514201
5. Power Board Assembly	3RE0B13514370
6. Audio Board Assembly with Cable	3RE0B13515320
7. CPU Board 166 MHz (5060 and 5060X) CPU Board 233 MHz (5080 and 5080X)	3RE0B13514720 3RE0B13515560
8. Fan Assembly	3RE0384300100
9. IRDA Board Assembly with Cable	3RE0B13515340
10. Top Cover (Keyboard)	3RE0111504240
11. LCD Assembly 12.1" TFT SVGA 13.3" TFT XGA	3RE0T43000520 3RE0T43000530
12. Left Hinge Cover 12.1" TFT SVGA 13.3" TFT XGA	3RE2234504450 3RE2234504330
13. Power Button	3RE2169504340
14. Right Hinge Cover 12.1" TFT SVGA 13.3" TFT XGA	3RE0234502020 3RE0234502030
15. Expansion Port Covers	3RE0124500120
16. Main Board 5060 5060X 5080 5080X	3RE0B13515480 3RE0B13515490 3RE0B13515470 3RE0B13515550
17. Speaker Assembly	3RE0A11000360
18. Keyboard	3RE4U27001460

19. Power Switch Board Assembly with Cable	3RE0B13515350
20. Retainer Clip (Keyboard) 2	3RE2356100080
21. Ribbon Cable (LED Board)	3RE4W37000180
22. Keyboard Retainer Cover	3RE2473500070
23. Battery, Backup	3RE4D25000310
24. Microphone Assembly	3RE0A21000060
25. Memory Cover	3RE0129500350
26. Sound Cable	3RE4W37000330
27. Ribbon Cable, IR to LED	3RE4W37000440
28. Mouse Cable	3RE4W37000200
29. VersaBay Detector Switch with Cable	3RE0B13515370
30. Left VersaGlide Button	3RE2169504320
31. Right VersaGlide Button	3RE2169504330
32. Shipping Carton (Brown Box)*	158-041020-000
33. Shipping Carton Litho*	158-041032-000
34. <i>NEC Versa 5000 Series User's Guide*</i>	819-200364-000
35. <i>NEC Versa 5000 Service and Reference Manual *</i>	819-200371-000
36. LCD Screw Cover*	3RE2234503752
37. LCD Lock*	3RE226500630A
38. VersaBay Release Cover*	3RE2129501090A
39. Audio Interface Board*	3RE0B13514220
40. Weight Saver Pack*	3RE2194501930
41. FDD Assembly with Cable	3RE0U24000130
42. CD-ROM Assembly*	3RE0U24700090
43. External FDD Cable*	158-057426-000
44. AC Adapter*	158-057421-000
45. AC Power Cable*	158-057422-000

* Not Shown in IPB Figure.

This data was prepared December, 1997. For an up-to-date listing of spare parts, please call FaxFlash (888) 329-0088 (international (978) 635-6090) and order document number 42200371.

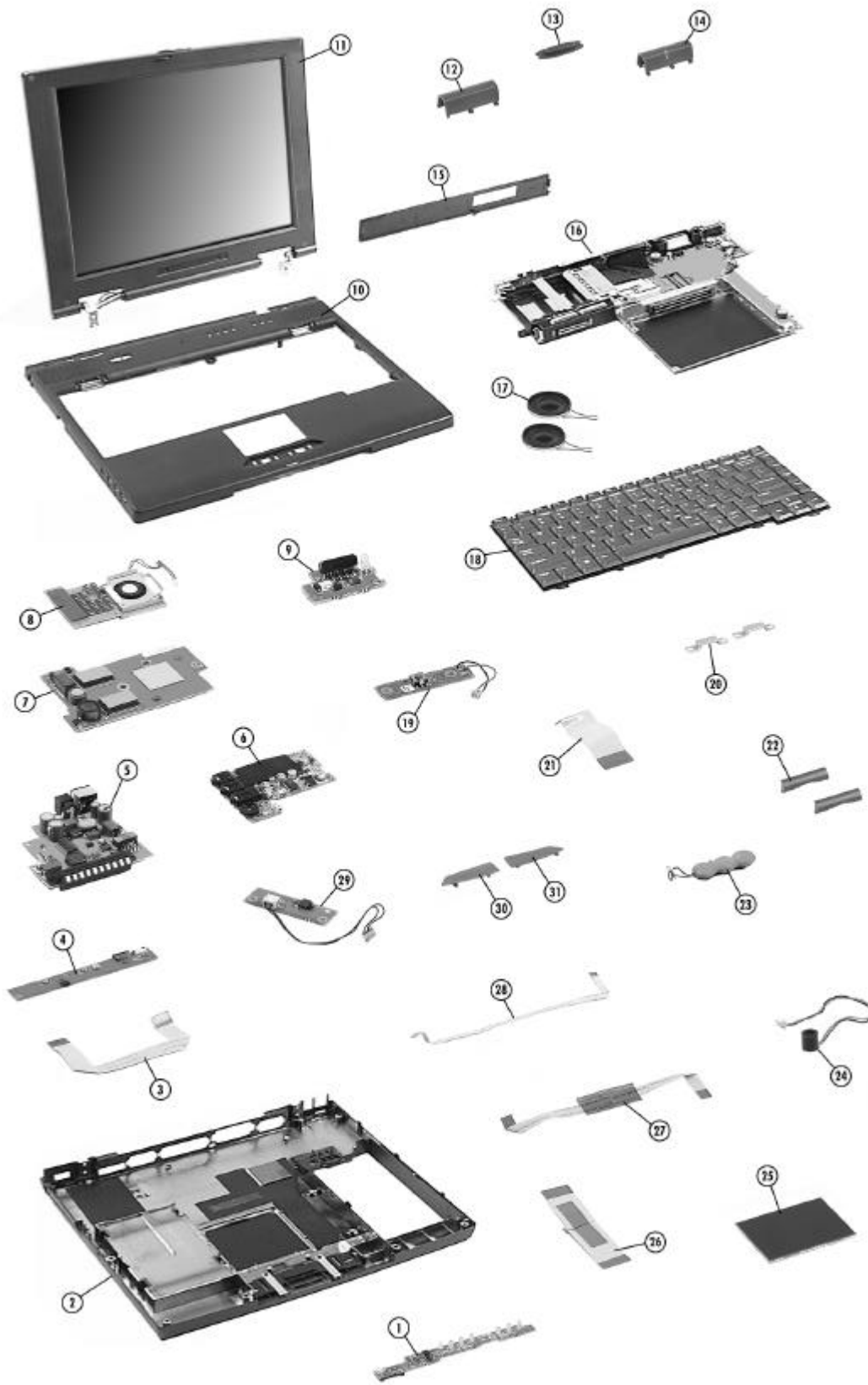

Figure 4-10 NEC Versa 5000 Series Illustrated Parts Breakdown

SERVICE INFORMATION

NEC service and information telephone numbers are listed in Table 4-4.

Table 4-4 NEC Service and Information Telephone Numbers

Service	Call
To order NECCSD spare parts	In the U.S., call 1(800) 632-4525
To order options in the U.S.	Local Sales Office
NECCSD Customer Service and Technical Support Center	In the U.S., call 1-800-632-4525
NECCSD Customer Assistance Center for extended warranties and contract information	1 (888) 632-9128

TECHNICAL SUPPORT

NECCSD Customer Service Response Center provides an E-mail service for Internet users. Technical questions regarding NEC products can be sent over the Internet system to the Center. The Internet address is as follows:

PRODUCT INFORMATION

NEC FaxFlash is an automated electronic information service used to obtain up-to-date product application notes, installation procedures, troubleshooting tips, data sheets, technical information bulletins, price lists, and other information.

Information can be obtained from the FaxFlash service 24 hours a day, 7 days a week. Using a touch-tone telephone, call the FaxFlash number, order the desired information through the automated attendant, and FaxFlash will automatically fax the information.

Catalogs that list the documents and the document numbers are available. Current catalogs include:

- Catalog 1 – Telephone Directory and information about Online Services
- Catalog 3 – Product specifications, warranty policy, UltraCare guidelines, and sales information
- Catalog 5 – Pro Serva and Express 5800 Server System technical support information
- Catalog 6 – NEC Ready Systems technical support information
- Catalog 7 – Powermate Systems technical support information
- Catalog 8 – NEC Portable System (including Versa Notebooks and MobilePro Handheld Personal computers) technical support information

ORDERING INFORMATION FROM FAXFLASH

Order information from FaxFlash as follows:

1. Check that the fax machine is on.
2. Locate the document part number.
3. Using a touch-tone telephone, call 1-800-329-0088 (U.S. and Canada only).

For international use, enter the international long distance access number, the U.S. telephone number, and the U.S. extension (1-978-635-6090).

4. Listen to the instructions provided by the automated attendant.

Press **1** to skip the FaxFlash introduction and jump to the automated instructions for ordering a document or catalog.

Press **2** for an introduction to FaxFlash, followed by the automated instructions for ordering a document or catalog.

5. When asked by the automated attendant, enter your fax number and telephone number.
-

For international use, first enter the international long distance access number (011), your country code, area code or city code, then your fax number.

The information requested will be sent automatically to your fax machine. If FaxFlash attempts to send the second order before the first order is completed, the order could be canceled. After three tries, FaxFlash assumes that the line is busy.

Appendix A

Connector Locations and Pin Assignments

Figure A-1 and Table A-1 show Main board connectors. The remaining tables provide pin assignments for additional system connectors.

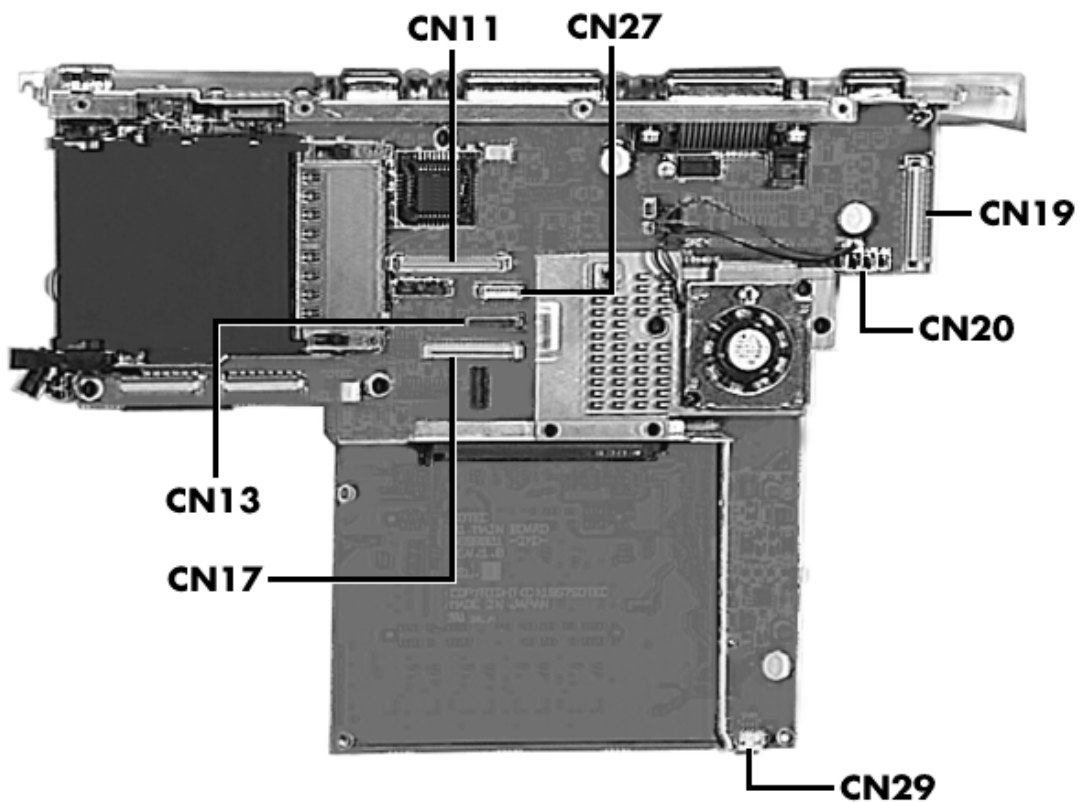

Figure A-1 CPU Board Layout

Table A-1 CPU Board Connectors

Connector	Description
CN1	CPU Assembly
CN11	LCD Panel
CN13	LED Status Bar
CN17	Keyboard
CN18	Power Board
CN20	Fan
CN27	LCD Panel
CN29	Memory Card Connector

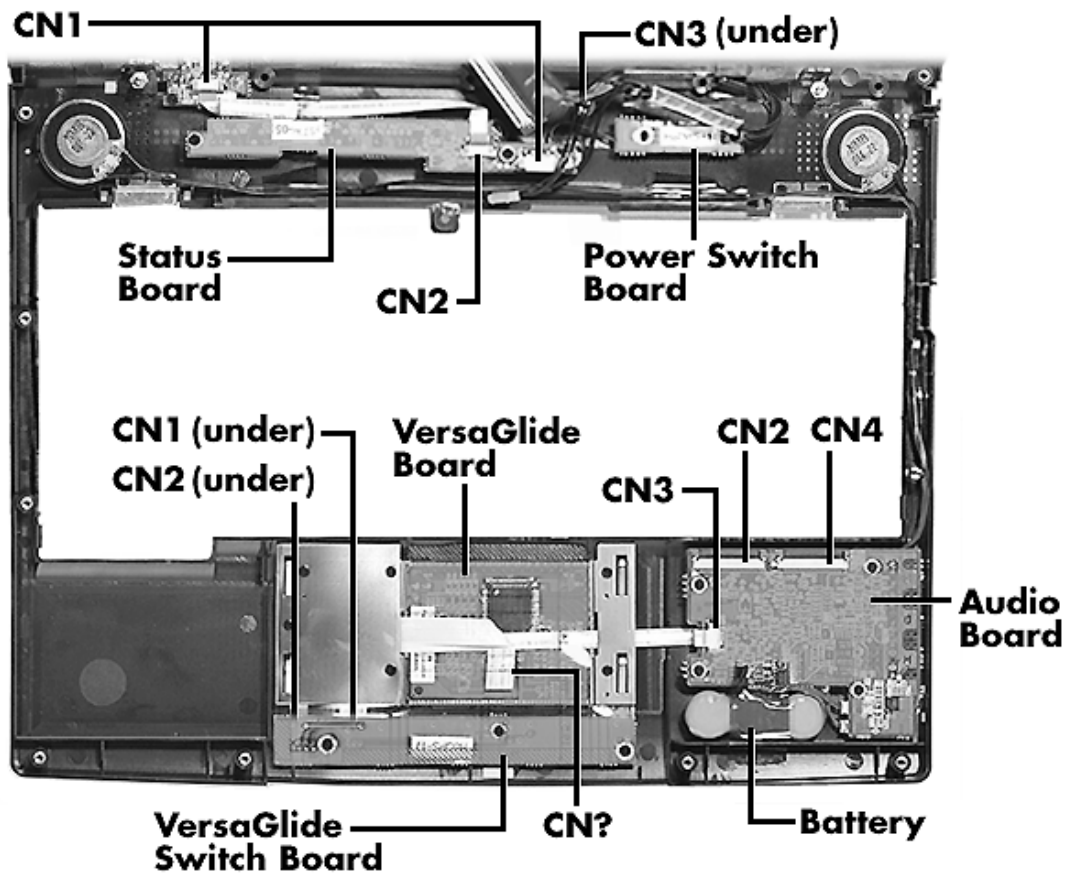

Figure A-2 I/O Board Layout

Table A-2 Top Cover Subassembly

Connector	Description
CN1 (LED Status Board)	Main Board (CN 13)
CN2 CN4 (Audio Board)	HDD Connector Assembly

Table A-3 Keyboard/Mouse Connectors

Pin	Signal
1	Keyboard Data
2	Mouse Data
3	Ground
4	+5V
5	Keyboard Clock
6	Mouse Clock

Table A-4 Serial Port Connector Pin Assignments

Pin	Signal
1	Data Carrier
2	Receive Data
3	Transmit Data
4	Data Terminal Ready
5	Ground
6	Data Set Ready
7	Request to Send
8	Clear to Send
9	Ring Indicator

Table A-5 CRT Connector Pin Assignments

Pin	Signal
1	Red
2	Green
3	Blue
4	OPT1
5	Ground
6	Ground
7	Ground
8	Ground
9	+5V PnP VESA Vcc
10	Ground
11	OPT2
12	PnP VESA Data
13	Horizontal Sync
14	Vertical Sync
15	PnP VESA Clock

Table A-6 Parallel Printer Pin Assignments

Pin	Signal
1	- Strobe
2	Data Bit 0
3	Data Bit 1
4	Data Bit 2
5	Data Bit 3
6	Data Bit 4
7	Data Bit 5
8	Data Bit 6
9	Data Bit 7
10	- Acknowledge
11	Busy
12	PE

Table A-6 Parallel Printer Pin Assignments

Pin	Signal
13	Select
14	- Auto Feed XT
15	- Error
16	- Initialize
17	- Select In
18 -25	Ground

Table A-7 Power Connector

Pin	Signal
1	Ground
2	DCSYS
3	DCCHG
4	Type

Table A-8 Hard Disk Drive Connector

Pin	Signal
1	HDD Access LED
2	+5V
3	Chip Select 0
4	+5
5	Chip Select 1
6	+5V
7	Address 0
8	+5V
9	Address 2
10	+5V
11	Address 1
12	+5V
13	Diagnostic
14	Not Used

Table A-8 Hard Disk Drive Connector

Pin	Signal
15	IRQ
16	DMACK
17	Not Used
18	IO Channel Ready
19	MS Select
20	IO Write
21	I/O Read
22	DMA Request
23	Data 0
24	Data1
25	Data15
26	Data14
27	Data2
28	Data13
29	Data3
30	Not Used
31	Data12
32	Ground
33	Data4
34	Ground
35	Data4
36	Ground
37	Data5
38	Ground
39	Data10
40	Ground
41	Data6
42	Ground
43	Data9
44	Ground
45	Data7
46	Ground

Table A-8 Hard Disk Drive Connector

Pin	Signal
47	Ground
48	Ground
49	RESET
50	Ground

Appendix B

Video Modes

The following tables list NEC Versa system video modes.

Table B-1 LCD Display Mode Setting (800x600 TFT Color LCD and Simultaneous CRT Display)

Mode (Hex)	Display Mode	Colors	Text Display	Pixel Resolution	Font	Video Memory (KB)
0*	Text	16 (gray)	40x25	320x200	8x8	256
0**	Text	16 (gray)	40x25	320x350	8x14	256
0***	Text	16	40x25	360x400	9x16	256
1*	Text	16	40x25	320x200	8x8	256
1**	Text	16	40x25	320x350	8x14	256
1***	Text	16	40x25	360x400	9x16	256
2*	Text	16 (gray)	80x25	640x200	8x8	256
2**	Text	16 (gray)	80x25	640x350	8x14	256
2***	Text	16	80x25	720x400	9x16	256
3*	Text	16	80x25	640x200	8x8	256
3**	Text	16	80x25	640x350	8x14	256
3***	Text	16	80x25	720x400	9x16	256
4	Graphics	4	40x25	320x200	8x8	256
5*	Graphics	4 (gray)	40x25	320x200	8x8	256
5**	Graphics	4 (gray)	40x25	320x200	8x8	256
5***	Graphics	4	40x25	320x200	8x8	256
6	Graphics	2	80x25	640x200	8x8	256

*CGA
**EGA
***VGA

Table B-1 LCD Display Mode Setting (800x600 TFT Color LCD and Simultaneous CRT Display)

Mode (Hex)	Display Mode	Colors	Text Display	Pixel Resolution	Font	Video Memory (KB)
7*	Text	Mono	80x25	720x350	9x8	256
7**	Text	Mono	80x25	720x350	9x14	256
7***	Text	Mono	80x25	720x400	9x16	256
D**/***	Graphics	16	40x25	320x200	8x8	256
E**/***	Graphics	16	80x25	640x200	8x8	256
F**/***	Graphics	Mono	80x25	640x350	8x14	256
10**/***	Graphics	16	80x25	640x350	8x14	256
11***	Graphics	2	80x30	640x480	8x16	256
12***	Graphics	16	80x30	640x480	8x16	256
13***	Graphics	256	40x25	320x200	8x8	256

* MDA

** EGA

*** VGA

Table B-2 LCD Display Mode Setting (800x600 TFT Color LCD and Simultaneous CRT Display)

Mode	Mode Type	Memory Org	Pixel Resolution	Color	Display Fonts	Font Size	Video Memory (KB)
100	Graph	Pack Pix	640x400	256	80x25	8x16	256
101	Graph	Pack Pix	640x480	256	80x30	8x16	512
102	Graph	Planar	800x600	16	100x37	8x16	256
103	Graph	Pack Pix	800x600	256	100x37	8x16	512
10D	Graph	Pack Pix	320x200	32K	40x25	8x8	256
10E	Graph	Pack Pix	320x200	64K	40x25	8x8	256
110	Graph	Pack Pix	640x480	32K	80x30	8x16	1024
111	Graph	Pack Pix	640x480	64K	80x30	8x16	1024
112	Graph	Pack Pix	640x480	16M	80x30	8x16	1024
113	Graph	Pack Pix	800x600	32K	100x37	8x16	1024
114	Graph	Pack Pix	800x600	64K	100x37	8x16	1024
115	Graph	Pack Pix	800x600	16M	100x37	8x16	1536

*200, 400 and 480 line modes are converted to 600 lines by the BIOS. Furthermore, 200 line mode is converted to 400 line mode with the double scanned.

Table B-3 CRT Display Mode (CRT only)

Mode (Hex)	Display Mode	Colors	Text Display	Pixel Resolution	Font	Refresh Rate
0, 1	Text	16	40x25	320x200	8x8	70
0*, 1*	Text	16	40x25	320x200	8x14	70
0**, 1**	Text	16	40x25	360x400	9x16	70
2, 3	Text	16	80x25	640x200	8x8	70
2*, 3*	Text	16	80x25	640x350	8x14	70
2**, 3**	Text	16	80x25	720x400	9x16	70
4,5*	Graphics	4	40x25	320x200	8x8	70
6	Graphics	2	80x25	640x200	8x8	70
7*	Text	Mono	80x25	720x350	9x14	70
7**	Text	Mono	80x25	720x400	9x16	70
D	Planar	16	40x25	320x200	8x8	70
E	Planar	16	80x25	640x200	8x8	70
F	Planar	Mono	80x25	640x350	8x14	70
10	Planar	16	80x25	640x350	8x14	70
11	Planar	2	80x30	640x480	8x16	60
12	Planar	16	80x30	640x480	8x16	60
13	Packed Pixel	256	40x25	320x200	8x8	70

*EGA Extension

**VGA Extension

Extended Video Mode

Mode	Mode Type	Memory Org	Pixel Resolution	Color	Display fonts	Font Size	Dot Colock (MHz)	Horiz. Freq (MHz)	Vert. Freq. (Hz)	Video Memory (KB)
101	Graph	Pack Pix	640x480	256	80x30	8x16	25.175 31.5 36	31.5 37.5 43.3	60 75 85	512
103	Graph	Pack Pix	800x600	256	100x37	8x16	40 49.5 56.25	37.8 46.9 53.7	60 75 85	512
105	Graph	Pack Pix	1024x768	256	128x48	8x16	65 78.75	48.3 60	60 75	1024

111	Graph	Pack Pix	640x480	64K	80x30	8x16	25.175 31.5 36	31.5 37.9 43.3	60 75 85	1024
112	Graph	Pack Pix	640x480	16M	80x30	8x16	25.175 31.5 36	31.5 37.5 43.3	60 75 85	1024
114	Graph	Pack Pix	800x600	64K	100x37	8x16	40 49.5 56.25	37.8 46.9 53.7	60 75 85	1024
115	Graph	Pack Pix	800x600	16M	100x37	8x16	40 49.5 56.25	37.8 46.9 53.7	60 75 85	1536
117	Graph	Pack Pix	1024x768	64K	128x48	8x16	65 78.75	48.3 60	60 75	1536

Table B-4 Panning Video Mode (800x600 TFT Color LCD and Simultaneous CRT Display)

Mode	Display Mode	Memory Org	Pixel Resolution	Col-ors	Text Display	Font Size	Video Memory (KB)
105	Graph	Pack Pix	800x600 (1024x768)	256	100x37 (160x64)	8x16	1024
116	Graph	Pack Pix	800x600 (1024x768)	32K	100x37 (128x48)	8x16	1536
117	Graph	Pack Pix	800x600 (1024x768)	64K	100x37 (128x48)	8x16	1536

BATTERY REPLACEMENT

A lithium CMOS clock battery in your computer maintains system configuration information. In the event that the battery fails to maintain system configuration information, NEC recommends that you replace the battery. Have an authorized NEC service representative replace the battery.

WARNING

There is a danger of explosion if the battery is incorrectly replaced. Replace only with the same or equivalent type recommended by the manufacturer. Discard used batteries according to the manufacturer's instructions.

ATTENTION

Il y a danger d'explosion s'il y a remplacement incorrect de la batterie. Remplacer uniquement avec une batterie du même type ou d'un type recommandé par le constructeur. Mettre au rebut les batteries usagées conformément aux instructions du fabricant.

BATTERY DISPOSAL

The bridge battery is made of nickel metal hydride (NiMH). The main battery and CMOS battery are made of lithium-ion (Li-Ion).

Contact your local waste management officials for other information regarding the environmentally sound collection, recycling, and disposal of the batteries. For additional information on the proper collection or disposal of rechargeable batteries, please call 1-800-8-BATTERY.

Index

A

AC adapter, 2-4
Accessing setup, 2-19
Active mode, 1-20, 2-29
Air vents, 1-7
Automatic power saving features, 1-19

B

Backup system disk, 4-2
Battery
 handling, 2-6
 leakage, 2-11
 recharging precautions, 2-11
 when to change, 2-5
Battery pack, 1-10, 1-11
 precautions, 2-10
 replacing, 4-5
Battery release latch, 1-10
Battery status, 2-5
Battery warning, 2-6
BIOS update, 1-16
Bridge battery, 1-13

C

Cable connections, 2-3
Cache RAM, 1-13
CD-ROM reader, 1-12
Chip types, 1-15
Cleaning
 internal components, 4-2
 outer surface, 4-1
Control keys, 2-15
CPU, 1-15
CPU board connectors, A-1
Creative Vibra 16S VLSI chip, 1-18
CRT connector pin assignments, A-4
Cursor Control keys, 2-15

D

Default power management settings, 1-20
Disassembly guidelines, 4-4

Diskette controller, serial interface, parallel interface, 1-17
Diskette drive, 1-7, 1-12
Display, 1-23

E

Emergency Reset Switch, 1-8
Expansion port, 1-11
External Diskette Drive connector, 1-11

F

Flash ROM, 1-16
Function keys, 2-14

H

Handling battery packs, 4-3
Hard disk drive, 1-10, 1-12
Hardware failures, 2-17
Hardware Overview
 VersaBay II, 1-7
Headphone port, 1-8

I

I/O board, 1-12
I/O connector descriptions, 2-3
Increasing system memory, 1-13
Interrupt level assignments, 1-18

K

Keyboard, 1-6, 1-24
Keyboard controller, 1-17
Keyboard/mouse connectors, A-3

L

LCD, 1-3
LEDs
 Battery/Charging Status, 1-5, 13
 Caps Lock, 1-5, 14
 CD-ROM reader, 1-5, 14
 diskette drive, 1-5, 14
 Num Lock, 1-5, 14
 Power, 1-5, 13

Scroll Lock, 2-14
Local power management, 1-20
Low battery power, 1-11, 2-5

M

Maintaining LCD quality, 4-3
Memory
 cache RAM, 1-13
Memory expansion slots, 1-10
Memory map, 1-13
Microprocessor, 1-15
Mobile Triton chipset, 1-15
Model configurations, 1-1
Monitor port, 1-11

N

NEC Versa disassembly sequence, 4-3
NEC Versa video modes, B-1
Numeric keys, 2-15

O

Operating controls, 2-12
Optional battery charger, 2-5
Ordering information from FaxFlash, 4-17

P

Parallel interface enhanced capabilities
 port, 1-14
Parallel port, 1-11
Parallel port pin assignments, A-5
Password, 2-26
Password override switch, 1-9
Password removal, 2-27
Password setting, 2-26
Password, forgotten, 2-27
Ports, 1-10
Post error messages, 2-17
Post errors, 2-17
Power
 longest battery life, 2-28
 maximum performance, 2-28
Power button, 1-4, 2-12
Power connector pin assignments, A-5

Power management

 Active mode, 2-29
 customize, 2-28
 default settings, 2-30
 power saving modes, 2-29
 Standby mode, 2-30
 Suspend mode, 2-30
Power Management
 How to use, 2-29
Power management modes
 active, 1-20
 local standby, 1-20
 suspend, 1-20
Power management overview, 1-19
Power management settings
 default, 1-20
Power sources, 2-4
Power-on self test (POST), 2-16
Product information, 4-17

Q

Quick troubleshooting, 3-1

R

Recharging the battery, 2-5
Removing a password, 2-27
Replacing the battery pack, 7, 4-5
ROM BIOS, 1-16

S

Security, 2-26
Serial interface, 1-14
Serial port, 1-11
Serial port connector pin assignments, A-3
Service telephone numbers, 4-16
Servicing a hard disk, 4-2
Servicing the system
 required tools, 4-4
Setting a password, 2-26
Setting power management levels
 using F7, 1-19
Setting system parameters, 2-21
 power, 2-28
Setup key functions, 2-20
Setup utility, 2-18
Setup utility screens

- Advanced, 2-25
- Exit, 2-29
- Main, 2-25
- Power Savings, 2-28
- Security, 2-26
- Side features, 1-7
- Smart power switch, 2-15
- Sound board, 1-12
- Standby mode, 1-20
- Suspend mode, 2-30
- System features
 - back, 1-10
 - bottom, 1-9
 - side, 1-7
- System Parameters, 2-16, 2-21
- System setup, 2-1
- System specifications, 1-22
- System video, 1-14

T

- Technical support, 4-16
- Troubleshooting
 - helpful questions, 3-4
- Typewriter keys, 2-15

U

- Unpacking, 2-1
- USB port, 1-11
- Using the battery pack, 2-5

V

- VersaBay II, 1-7
- VersaGlide, 1-6
- Versa Tools Catalog, 2-5
- VGA controller, 1-17
- Video mode
 - CRT only, 1-14
- Video RAM, 1-14
- Volume control dial, 1-8
