

Contents

| | |
|---|----|
| Chapter 1: Getting Started | 3 |
| Keyboard and LCD | 4 |
| System status indicators | 6 |
| Left side..... | 7 |
| Back | 8 |
| Bottom | 10 |
| Right side | 12 |
| | |
| Chapter 2: Using Your System | 13 |
| Connecting AC power..... | 14 |
| Starting up..... | 15 |
| LCD panel..... | 15 |
| Using the keyboard..... | 16 |
| Function key combinations..... | 17 |
| Special keys | 19 |
| Numeric keypad | 19 |
| Using the pointing device..... | 20 |
| Connecting the modem | 28 |
| Swapping Option Bay modules | 29 |
| Using audio | 32 |
| Adjusting the volume | 32 |
| Making an audio recording | 33 |
| Using disc media | 34 |
| Playing an audio CD | 35 |
| Removing or replacing the hard disk drive | 37 |
| Using PC Cards | 39 |
| About CardBus cards | 40 |
| Using Universal Serial Bus (USB) ports | 40 |
| Using Fast Infrared (IR) ports | 40 |
| Using Composite Video Out..... | 41 |
| Using ATI Player..... | 42 |
| | |
| Chapter 3: Managing Power Consumption | 45 |
| Maintaining battery power | 46 |
| Battery learning software | 46 |
| Battery status | 48 |

Thank you for purchasing this Factory Service Manual CD/DVD from servicemanuals4u.com.

Please check out our eBay auctions for more great deals on Factory Service Manuals:

servicemanuals4u

| | |
|--|-----------|
| Swapping batteries | 49 |
| Maximizing battery life | 51 |
| Managing power | 52 |
| Windows 98 | 52 |
| Windows 95 and Windows NT | 55 |
| Using the Power menu..... | 56 |
| Status menu | 58 |
| Chapter 4: Getting Online | 59 |
| Using the Internet..... | 60 |
| Using e-mail | 61 |
| Sending e-mail | 62 |
| Checking your e-mail | 63 |
| Exploring the World Wide Web | 65 |
| Using Microsoft Fax | 67 |
| Setting up Microsoft Fax | 67 |
| Sending and receiving faxes..... | 69 |
| Appendix A: Solo Notebook Accessories | 71 |
| Accessories..... | 72 |
| Appendix B: Contacting Gateway | 73 |
| Contacting Gateway..... | 74 |
| Index | 75 |



Getting Started

| | |
|--------------------------------|----|
| Keyboard and LCD | 4 |
| System status indicators | 6 |
| Left side..... | 7 |
| Back..... | 8 |
| Bottom..... | 10 |
| Right side | 12 |





Keyboard and LCD

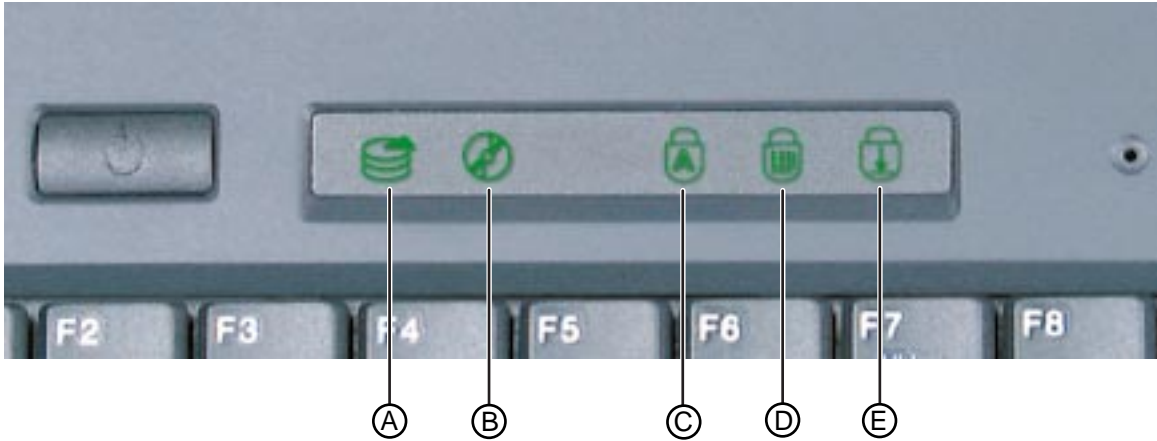

| Component | Description |
|---|---|
| A. XGA TFT Color Liquid Crystal Display (LCD) | Backlit anti-glare screen. |
| B. Power button | Turns power ON or OFF. Can also be configured to Standby/Resume mode. |
| C. Keyboard | Provides full functionality of a desktop computer keyboard. Many of these keys have assigned alternate functions, including shortcut keys for Windows 98 and Windows 95, Status Display menus, and numeric keypad. |
| D. Speakers | Provide high quality sound reproduction for software and audio CDs. |
| E. DVD/120MB SuperDisk -or- CD/diskette | Reads DVDs, CDs, standard diskettes, and 120MB diskettes. -or- Reads CDs and standard diskettes |
| F. EZ-Pad™ TouchPad or EZ-Point™ stickpoint | Controls the cursor movement on the screen. (EZ-Point™ stickpoint - U.S. keyboards only.) |
| G. Hard drive access cover | Opens to reveal the hard disk drive. |
| H. Power LED | Indicates the power status mode: <ul style="list-style-type: none"> • Steady green light indicates power is on and computer is in operation. • Flashing green light indicates that the computer is in standby mode. • No light indicates that the computer is off. |
| I. Battery LED | Indicates the battery status mode: <ul style="list-style-type: none"> • Green light indicates that the battery is fully charged. • Yellow light indicates that the battery is charging. • Red light indicates a battery malfunction. • No LED indicates that the system is running on the battery because the AC adapter is either not connected or is not providing power to the computer. |
| J. System status indicators | Indicate system status modes. |



System status indicators



| Indicator | Icon | Description |
|--|---|---|
| A. Hard drive access light |  | Indicates that the hard drive is in use. |
| B. DVD/120 MB SuperDisk or CD/diskette drive |  | Indicates that the DVD/120 MB SuperDisk or CD/diskette drive is in use. |
| C. Caps lock |  | Indicates that the caps lock is on. When the Caps lock light is on, you type in all capital letters. |
| D. Pad lock |  | Indicates that the pad lock is on. When the Pad lock light is on, you can access the secondary numeric keypad. |
| E. Scroll lock |  | Indicates that the scroll lock is on. With some programs, you can scroll through large volumes of text when scroll lock is turned on. |







Left side

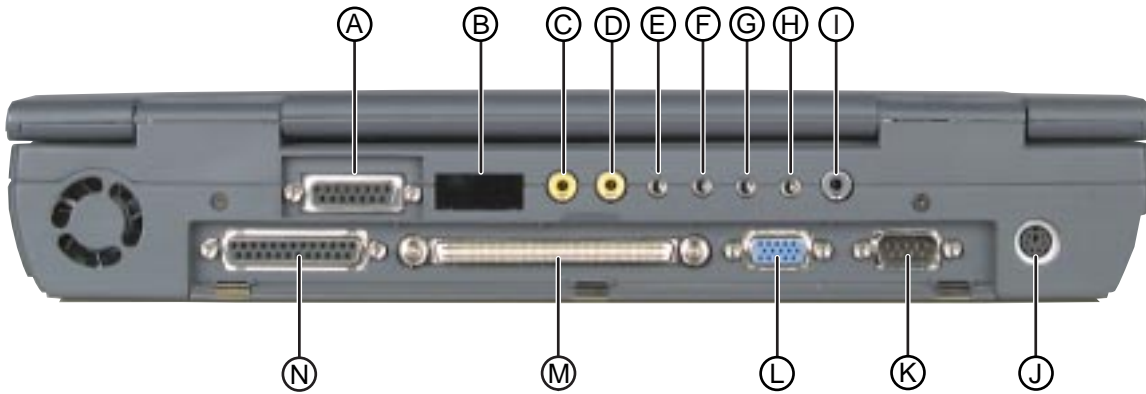









| Component | Icon | Description |
|------------------|---|---|
| A. Volume wheel |  | Adjusts built-in speaker, external speaker, and headphone volume. Volume levels are also controlled by multimedia software. |
| B. Modem jack |  | Plug a phone line into this jack to connect the notebook's on-board modem to an analog phone system. |
| C. PC Card slots | | Accepts one Type III PC Card or two Type I or Type II PC Cards. |
| D. Eject buttons |  | Ejects the PC Cards from the PC Card slots. |

Back



| Port | Icon | Description |
|----------------------------|---|---|
| A. Joystick/MIDI port |  | Connect a game joystick or an electronic MIDI musical instrument to this port. The port provides both MIDI In and Out capabilities. |
| B. Fast IR (Infrared) port |  | Sends infrared signals between the notebook and a remote device, such as another computer, printer, or peripheral. You can place infrared devices up to 3 feet (1 meter) apart. |
| C. Composite Video Out |  | You can view your notebook screen on a TV by connecting the notebook to the TV or VCR using a standard video cable. |
| D. Composite Video In |  | You can display NTSC or PAL format video on your notebook's screen from a VCR or video camera using a standard video cable. |
| E. Mic |  | Connect to an external microphone. (Using this connection will disable the built-in microphone.) |
| F. Line In |  | Audio line level input from another computer, stereo equipment, or a VCR. |

| Port | Icon | Description |
|-----------------------------------|---|---|
| G. Line Out |  | Audio line level output to another computer, stereo equipment, or a VCR. Line Out is not capable of driving unamplified speakers or headphones. |
| H. Speaker out/ Headphone jack |  | Connect to external speakers or headphones. Supports small unamplified speakers. (1/8-inch/3.5-mm jack.) |
| I. Dolby Digital Out |  | Connect to an (optional) surround-sound decoder. This connection will only provide DVD audio. |
| J. PS/2 port |  | Connect to an external mouse or keyboard. |
| K. Serial port |  | Connect to an optional serial device. |
| L. VGA |  | Connect to a VGA monitor cable. |
| M. Docking station port |  | Connect an optional docking station to this port. |
| N. Parallel port (LPT1) |  | Connect a parallel device (such as a printer) to this port. |

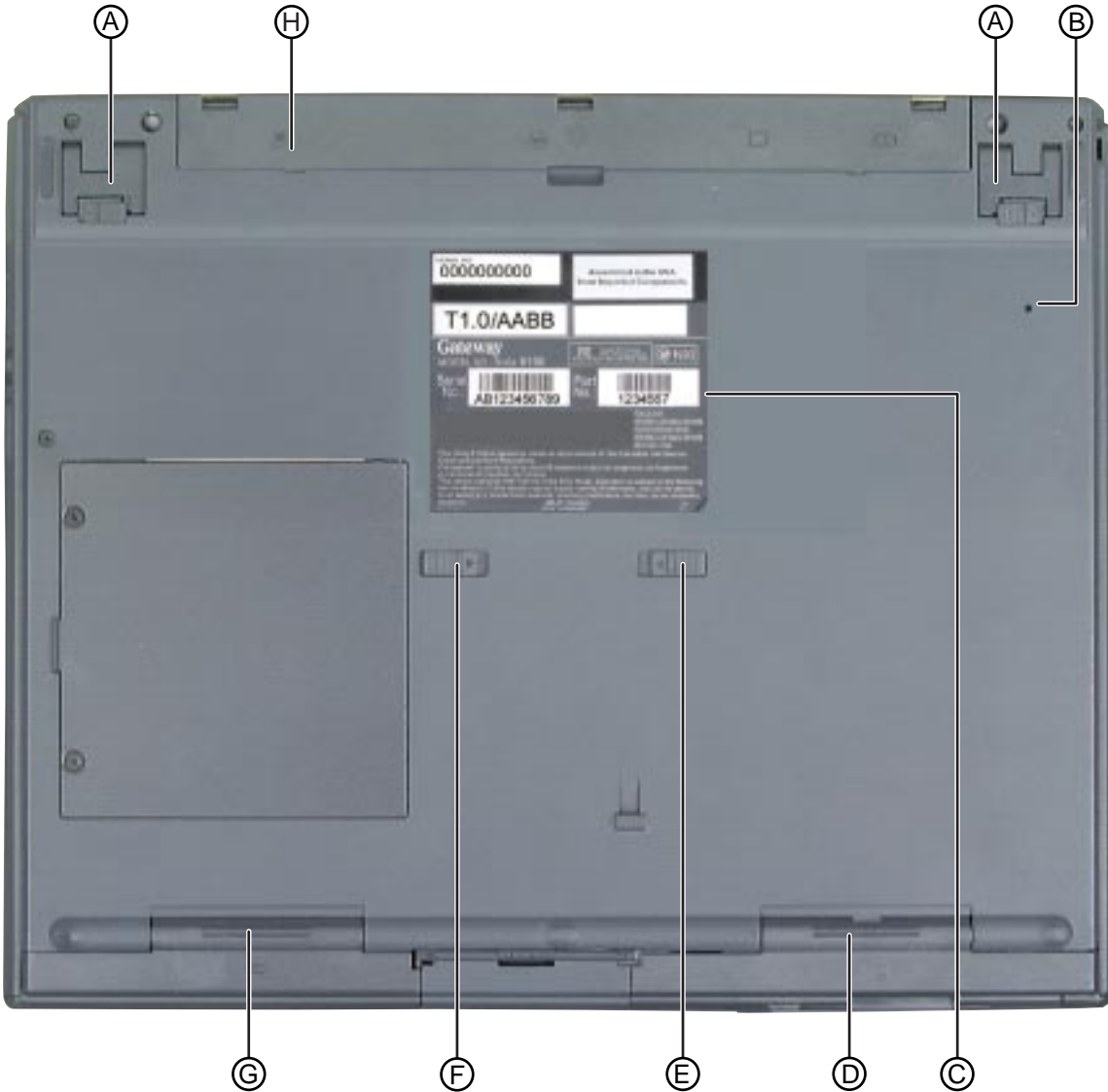

Bottom



| Component | Description |
|-------------------------------------|---|
| A. Flip foot | Flips out to tilt the notebook. |
| B. Reset switch | Restarts the notebook, if necessary. Insert a paper clip to press switch. |
| C. System identification label | Provides product model number, serial number, display type, and processor speed. |
| D. Combination module | Slide module into bay for use of a DVD/120MB SuperDisk or CD/diskette combination module. |
| E. Combination module release latch | Slide the latch to release the combination drive module from the bay. |
| F. Battery release latch | Slide the latch to release the battery pack from the battery pack bay. |
| G. Battery pack bay | Slide battery pack into bay for battery power and battery charging. |
| H. Back ports cover (open position) | Flips open to reveal ports. |

Right side



| Component | Icon | Description |
|-------------------------|---|--|
| A. USB ports |  | Plug optional USB serial devices into these ports. |
| B. Power connector |  | Connect to an AC power adapter. |
| C. Kensington lock slot |  | Attach a Kensington lock into this slot. A Kensington lock is an optional cable lock for portable computers. |



Using Your System

| | |
|--|----|
| Connecting AC power..... | 14 |
| Starting up..... | 15 |
| LCD panel..... | 15 |
| Using the keyboard..... | 16 |
| Using the pointing device..... | 20 |
| Using an external mouse or keyboard..... | 27 |
| Swapping Option Bay modules | 29 |
| Using audio | 32 |
| Using disc media | 34 |
| Removing or replacing the hard disk drive..... | 37 |
| Using PC Cards | 39 |
| Using Universal Serial Bus (USB) ports | 40 |
| Using Fast Infrared (IR) ports | 40 |
| Using Composite Video Out..... | 41 |

Warning!

To avoid serious injury, replace the power cord if it becomes damaged. The replacement cord must be of the same type and voltage rating as the original cord.

Connecting AC power

Your notebook is powered by one of the longest-lasting batteries available and was shipped to you charged and ready to use. You may want to use the AC adapter while you are checking out some of the features.

Connecting the AC adapter

1. Connect the power cord to the AC adapter.



2. Plug the AC adapter into your notebook's power connector.



3. Plug the power cord into an electrical outlet.

Warning!

Do not attempt to disassemble the AC adapter. The AC adapter has no user-replaceable or user-serviceable parts inside and has dangerous voltages that can cause serious personal injury or death. Contact Gateway about returning defective AC adapters.

Starting up

Slide the latch on the front face of your notebook to the right to release the cover and open up your notebook. To turn on your notebook, press the power button, located in the upper left corner of the notebook and close to the left LCD hinge.

The power button on your notebook is preset to On/Off mode. However, you can set it to function either in On/Off or Standby/Resume mode using the power menu.



Power
button

LCD panel

Your notebook features a color LCD XGA TFT 14.1-inch or 15.0-inch panel that provides sharp, crisp resolution and up to 16 million colors.

This notebook is shipped with the “Auto dim with battery” feature enabled. Auto dim cuts LCD power 50% when your notebook is operating on battery power. To disable this feature, refer to the chapter “Using Your BIOS Setup Program” in the *Maintaining and Troubleshooting Guide* that shipped with your notebook.

Tilt your notebook’s entire cover forward or backward to adjust the viewing angle. Press the FN key together with the up arrow and down arrow keys to control display brightness.

Note:

For instructions on accessing the power menu, see “Using the Power menu” on page 56.

Using the keyboard



- A.** Numeric keypad
- B.** Function keys
- C.** Shortcut keys

Your notebook features a full-size keyboard that has the same functionality as a desktop computer keyboard. Many of the keys have been assigned alternate functions, including shortcut keys for Windows, function keys for particular system operations, and padlock keys that enable a numeric keypad.

Function key combinations

Press the FN key together with one of the following keys to get these “on-the-fly” functions:

| Key Combination | Description |
|---|--|
|  | |
| F2 Status | Displays the power status in the upper left corner of the Windows desktop. Press the key combination again to make the power status disappear. |
| F3 LCD/CRT | Toggles between the LCD display, external monitor, both displays at the same time, or TV display (NTSC or PAL format). |
| F4 Standby | Windows 98™: Notebook goes into Standby mode. Pressing the power button brings the notebook out of Standby mode. Windows 95™ and Windows NT™: Notebook goes into Suspend mode. Pressing the power button brings the notebook out of Suspend mode. |
| F7 Video Source | Makes changes to the video source (VIDEOSRC) settings by toggling the following settings: DVD - if using the DVD drive. TV IN - if using the Composite Video In port. PCMCIA - if using a zoomed video card in PCMCIA slot. DISABLED - if 30 seconds pass, display disappears. |

★ Important!

In Windows 98™, Microsoft® has replaced the term “Suspend” with “Standby.”

Standby is used when referring to Windows 98™ and Suspend is used when referring to Windows 95™ or Windows NT™.

| Key Combination | Description |
|-----------------|-------------|
|-----------------|-------------|

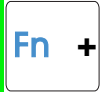

Enables the Pad Lock function so you can use the numeric keypad. The Pad Lock icon stays lit while this function is enabled. Press the key combination again to disable the numeric keypad.



In some applications, this lets you scroll through large volumes of text. The Scroll Lock icon stays lit as long as this function is enabled.



In some programs, this key combination pauses the display when text is scrolling quickly. Press any key to continue the text flow.



In some programs this key combination breaks text scrolling on a DOS screen.





Increases LCD brightness and displays the brightness meter for the Popup Status Display. Use the FN+F2 key combination to make the display disappear.



Decreases LCD brightness and displays the brightness meter for the Popup Status Display. Use the FN+F2 key combination to close the brightness meter.

Special keys

The following keys help you use shortcuts when working with some software:

| Key | Description |
|---|---|
|  | Displays the Windows Start menu. |
|  | Provides quick access to shortcut menus and help assistants in Windows. |

Numeric keypad

Press FN+F9 (PAD LOCK) keys to activate the numeric keypad. The section of keyboard below functions as a numeric keypad. Press FN+F9 to return the keyboard to standard mode.

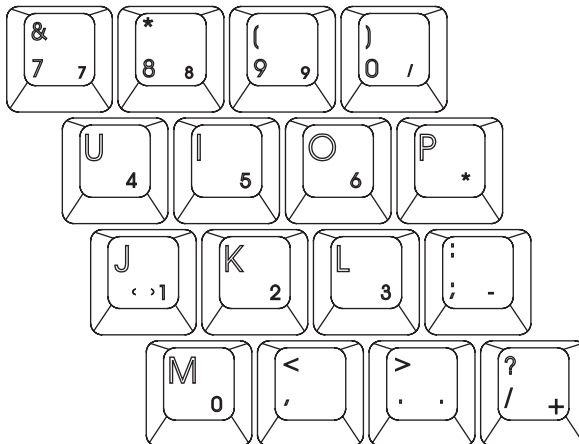

Using the pointing device

Your notebook came with either the EZ Pad™ TouchPad or the EZ Point™ stickpoint pointing device. Like a mouse, these pointing devices control the cursor movements on the display.

Also, you can use an external mouse. Connect the mouse device to the PS/2 port, the USB port, or the serial port. Review this section to find out more about these pointing device options.

Using the EZ Pad TouchPad

The EZ Pad TouchPad provides you with fast and easy navigation in large documents, spreadsheets, e-mails, and when using the Internet. You can scroll, zoom, autoscroll, and pan with the convenience of the touchpad. Scrolling capabilities are available in some Windows applications, including Microsoft Office.

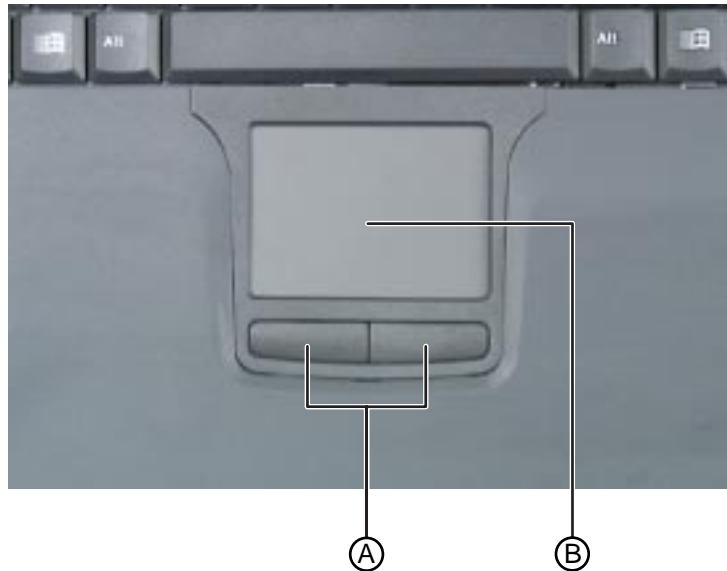





- A.** EZ Pad (TouchPad)
- B.** EZ Pad buttons (mouse buttons)

This touchpad uses one surface for both mouse and wheel actions, which means you can perform all of the wheel mouse actions without using the buttons on the notebook. The touchpad also uses movements of one, two, or three fingers to perform the left, middle, and right mouse button actions.

When your finger reaches the edges of the touchpad, you can continue to move the cursor and drag objects. You can also move horizontally and vertically without being constrained by the size of the touchpad. This is especially useful when dragging objects and selecting text because there is no need to remove your finger until the action is complete.

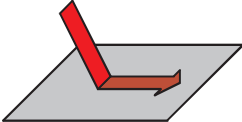
Mouse and TouchPad action equivalents

All of the mouse and wheel functions are illustrated and described in the following table.

| Mouse Action | TouchPad Action |
|---------------------|---|
| Move cursor |  |
| Left button click |  |
| Middle button click |  |
| Right button click |  |

Mouse Action**TouchPad Action**

Left button double click



Double tap 1 finger.

Left button drag

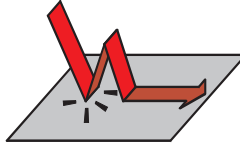



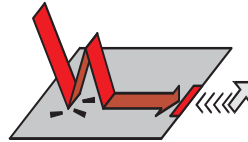

Double tap and drag.

Smart Edges

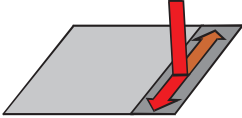

Double tap and drag.
When your finger stops at an edge of the TouchPad, the cursor continues moving across the screen until you lift or move your finger away from the edge of the TouchPad.

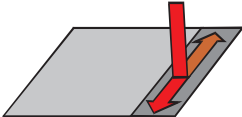
Mouse wheel equivalents

| Wheel Mouse Action | TouchPad Equivalent |
|--|--|
| Rotate the mouse wheel (roller) |  <p>Scrolling Up/Down: Place finger on right edge of the TouchPad and move up/down.</p> |
| CTRL + rotate the wheel |  <p>Zoom in/out: Press CTRL while moving finger along the right edge of the TouchPad. This changes the magnification of the document.</p> |
| SHIFT + rotate the wheel |  <p>Data zoom: Press SHIFT while moving finger along the right edge of the touchpad. You can jump to a hyperlink, return to previous Web sites using Internet Explorer, or expand or collapse menu trees in Windows Explorer using this method.</p> |
| Click on the wheel (middle mouse button) |  <p>Autoscroll: Tap with two fingers to drop an <i>Origin</i> mark. As the cursor moves away from this origin, the document scrolls. The direction and distance from the origin controls the scrolling direction and speed. Any subsequent key-stroke, mouse click, or roller action stops the scrolling action.</p> |

**Wheel Mouse
Action**

**TouchPad
Equivalent**



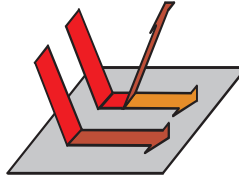

Press the wheel
(middle mouse
button)



Panning:

Same function as Auto-
scroll, except that the
action stops when you lift
your fingers.

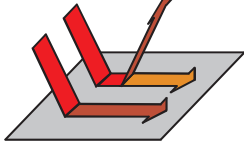
Advanced mouse and TouchPad action equivalents

| Mouse Action | | TouchPad Action |
|----------------------------|---|--|
| Middle button double click |  | Double tap 2 fingers. |
| Right button double click |  | Double tap 3 fingers. |
| Middle button drag |  | Slide 2 fingers. (2nd finger does not need to stay on the pad.) |
| Right button drag |  | Drag 3 fingers. (2nd and 3rd finger do not need to stay on the pad.) |

Changing touchpad properties

Use the following procedure to change EZ Pad properties including pointer size, button assignments, cursor speed and acceleration, scrolling speed, and edge motion.

To customize the EZ Pad

1. Double-click the  icon in the task tray (bottom right corner). The touchpad dialog box opens.

2. Click a tab in the **Mouse Properties** dialog box, then customize the touchpad functions.

In the taskbar located in the lower left corner of your screen click , then **MouseWare Help** to find more help about using the touchpad.

Using the EZ Point stickpoint

The EZ Point pointing device (U.S. keyboards only) provides an easy way to move the cursor across the screen and navigate through software. The EZ Point consists of a stick located on the keyboard between the G and H keys and two click buttons below the spacebar.

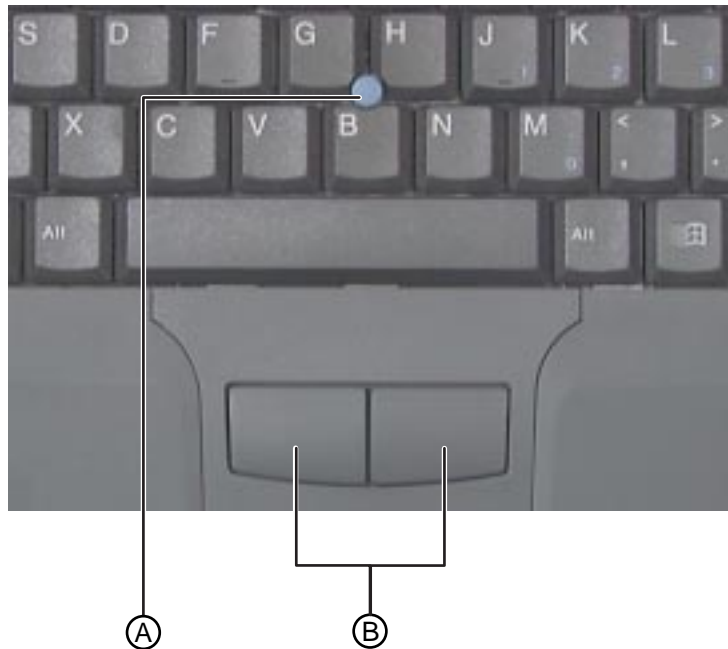

- A. EZ Point stickpoint
- B. EZ Point select buttons (mouse buttons)

To use the EZ Point

1. Place your hands in the typing position and press the EZ Point stickpoint in the direction you want to move the cursor.
2. Press the EZ Point buttons to select items as you would with a mouse.

Changing EZ Point properties

Use the following instructions to change EZ Point properties including pointer size, button assignments, cursor speed, and acceleration.

To customize the EZ Point

1. Click **Start**, **Settings**, then **Control Panel**. The Control Panel opens.
2. Double-click the **Mouse** icon. The **Mouse Properties** window opens.
3. Click the tab of your choice and customize the EZ Point features.

Click **Apply** to save a change and keep the **Mouse Properties** window open.
4. When all modifications have been made, click **OK**. The **Mouse Properties** window closes.

Using an external mouse or keyboard

You can attach an external mouse or keyboard to the notebook using the PS/2 port, the USB port, or the serial port. It is not necessary to shut down the notebook before connecting to an external PS/2 mouse or keyboard.

Connecting the modem

Your Solo 9150 notebook came with a built-in 56K data/fax/voice modem and a telephone cable. (The Solo 9150's internal modem is only available in the U.S., Canada, Japan, and Australia.)

To connect and use the modem

1. Insert one end of the telephone cable into the modem jack on the left side of the notebook.



2. Insert the other end of the telephone cable into any analog telephone wall jack.
3. Start your computer, then start your communications software.

For more information on using your notebook's modem and network connections, see Chapter 4, "Getting Online."

Swapping Option Bay modules

Your notebook shipped with a DVD/120 MB SuperDisk or CD/diskette combination drive. The modular option bay will accept the combination drive or an additional battery. You must restart your notebook each time they are swapped.



To switch the combination module for the battery module

1. Save all work.
2. Use your operating system's **Shut Down** procedure.
3. Close the cover and turn your notebook over.
4. Locate the modular bay access latch.
5. Slide and hold the latch open, then place your fingers over the raised bar near the front of the notebook.

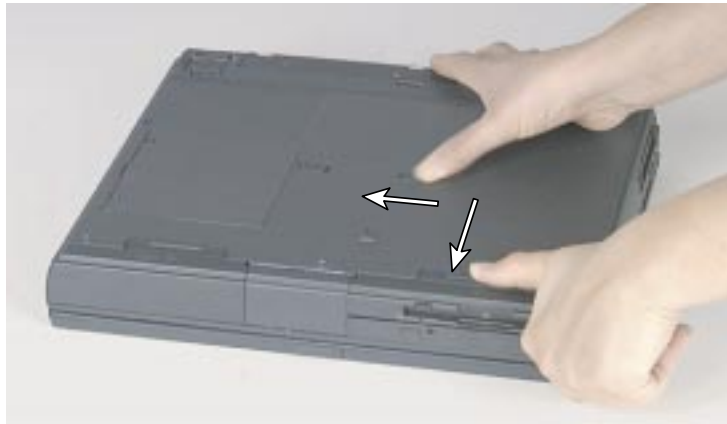

6. Pull the combination drive module straight out and away from your notebook, then release the latch.



7. Install the correct faceplate on the second battery. For details, see the instructions that come with the second battery.
8. Turn the battery module over. (Your notebook was already turned over, so the module being installed must be turned over as well.)
9. Firmly push the module straight into the bay until the latch clicks into place. If you don't hear the click, try it firmly again, making sure it clicks.
10. Restart your system.

★ *Important!*

Anytime you replace a module, you must restart your notebook for the module to work. The restart has to occur **after** the module is correctly seated.

Using audio

You can record audio for presentations, attach voice messages to your e-mail, listen to audio CDs, and use your notebook's audio function for many other multimedia applications.

Adjusting the volume

There are many ways to adjust audio input and output on your Solo notebook computer. The volume control wheel controls the Speaker Out port and the internal system speakers. The volume level for other ports is controlled by the multimedia software.

To adjust playback and recording volume levels

1. Click **Start**, **Settings**, then **Control Panel**.
2. Double click the **Multimedia** icon. The **Multimedia Properties** dialog box opens.
3. Click the **Audio** tab.
4. Set the **Playback** and **Recording** levels to your preference.

To adjust volume controls

1. Double-click the Speaker icon on the taskbar.

A **Volume Control** dialog box opens, containing volume and balance controls for master volume control, CD audio, wave, synthesizer, line, microphone, and 3D Enhanced settings.



2. Slide the various volume and balance controls to suit your requirements.

Making an audio recording

To make an audio recording, use the built-in microphone or connect an external microphone to the Mic port.

To make an audio recording

1. Click **Start, Programs, Accessories, Multimedia**, then **Sound Recorder**. The Sound Recorder opens.
2. Click **Edit, Audio Properties**, then set or check record volume levels.
3. Click **OK**.
4. Click ● (Record). Recording starts.
5. When you are finished recording, click ■ (Stop). Recording stops.
6. Click **File**, then **Save As**.

Note:

Connecting an external microphone will disable the built-in microphone.

7. Name the recording.
8. Click **Save**. The recording is saved.

To play back a recording in Media Player

1. Click **Start, Programs, Accessories, Multimedia**, then **Media Player**. The Media Player opens.
2. Click **File**, then **Open**. The **Open** dialog box appears.
3. Select the file to play back.
4. Click **Open**.
5. To play the file, click ► (Play) button. To stop the file, click ■ (Stop) button.

Using disc media

Your notebook may have a DVD drive. This section describes some of the ways to use it.

★ *Important!*

Be sure to place the DVD in the tray so that the label side is facing up. If the disc has two playable sides, place the disc so that the name of the side you want to play is facing up.

To insert a DVD

1. Press the eject button. The DVD drive tray opens.
2. Insert the DVD.
3. Press down carefully on the DVD to ensure that it snaps under the clips that hold the DVD in the tray.
4. Push the tray in. The tray closes.

To access information on the DVD drive

After inserting the DVD, the program should autorun. If it does not, follow the directions below.

1. Double-click the **My Computer** icon. The My Computer window opens.
2. Double-click the DVD-ROM drive icon. The DVD application will appear.



Playing an audio CD

Both DVD and CD-ROMs accept standard data and music CDs. You can play and control an audio CD using the Windows 98 or Windows 95 CD Player application.

To play an audio CD

1. Insert an audio CD. After a few seconds, the CD starts playing automatically.
2. If the CD did not auto-start, then click **Start, Programs, Accessories, Multimedia**, and **CD player** to start the CD player software.
3. Slide the mouse pointer slowly over the control buttons on the CD Player software to get familiar with each button function.



You can change music tracks, view playing times, control the volume, set preferences, define a play list, and even set the system to continuous or random play using the dialog box.

4. Control audio play as desired.

Removing or replacing the hard disk drive

If you choose to increase your storage space with a larger hard disk drive, follow the instructions below to remove and replace the drive.

To remove and replace the hard disk drive

1. Save all work.
2. Use your operating system's shut down procedure to turn your notebook completely off.
3. Close the LCD lid.
4. Disconnect the AC power and turn your notebook over.
5. Locate the modular bay access latch on the bottom of your notebook, then slide and hold the latch open.

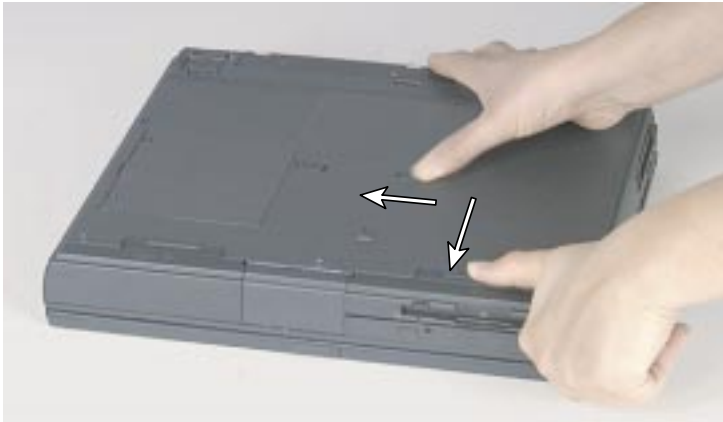

6. Remove the combination DVD/120 MB SuperDisk or CD/diskette module from the modular option bay.

7. Open the flap door next to the modular option bay to expose the hard drive.

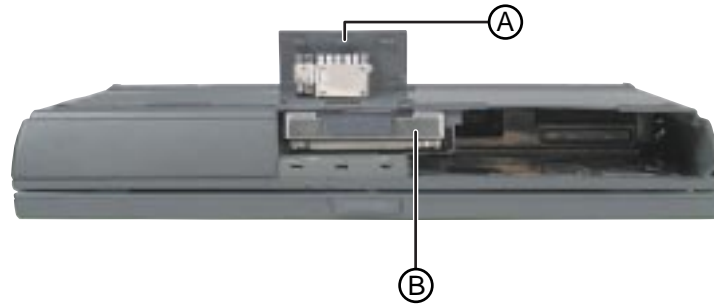

- A. Flap door
- B. Hard disk drive

8. Grasp the hard disk drive flap and pull the hard disk drive straight out from the notebook.



9. Slide the new hard drive firmly into your notebook and close the door.

Do not force the hard disk drive!

10. Reinstall the drive module and connect the AC adapter.

Using PC Cards

PC Cards, such as network and modem cards, interface with your hard disk drive. Your notebook's PC Card slots (also known as PCMCIA card slots) are located behind the PC Card doors. These slots accept PC Card 16, PC Card 32 (CardBus), or Zoomed Video cards.

You do not need to restart your notebook when changing most cards because your notebook supports "hot-swapping." This means that you can insert a PC Card while your notebook is running. If your PC Card does not work after hot swapping, refer to the PC Card manufacturer's documentation for further information.

★ *Important!*

If you are using a Type III PC Card, it must be inserted into the bottom slot.

To insert a PC Card

1. Insert the PC Card with the label face up.

Push the card firmly into the PC Card slot. When the card is installed correctly, the computer plays a two-toned beep.

To remove a PC Card

1. Click the **PC Card** icon in the taskbar.
2. Click the card that you want remove.
3. Click **Stop**. A screen appears telling you that you may safely remove the device.
4. Click **OK**.
5. Press the PC Card eject button once to release the eject button.
6. Press the PC Card eject button twice to eject the PC Card.
7. Press the PC Card eject button three times to reset the eject button.

About CardBus cards

The 32-bit CardBus technology (sometimes referred to as “PC Card 32 cards”) supports DMA and bus mastering technologies that are useful in performance-intensive applications such as full-motion video, high speed network connections, full-motion video capture and display, and high performance peripheral interfaces.

32-bit CardBus cards can be used interchangeably with 16-bit cards in your notebook. However, some Solo docking solutions do not support CardBus. CardBus cards function only in your notebook’s PC Card slots.

Using Universal Serial Bus (USB) ports

USB is an interface that serves as a single port alternative to connecting devices that traditionally have required their own specific ports such as mice, joysticks, keyboards, scanners, video conferencing cameras, and speakers.

To use a USB-compatible device, connect it to the USB port. The USB automatically installs and configures the necessary drivers and notebook resources.

Using Fast Infrared (IR) ports

The IR port uses infrared technology to send and receive signals between the notebook and a remote device also equipped with an IR port.

Your notebook shipped with the IR port enabled. A variety of desktop computers, printers, and other peripherals are IR-equipped. To set up a remote IR device, follow manufacturer instructions.

If you do not use the IR port and need to make more resources (IRQs) available for other commonly used devices, the IR port can be disabled.

Using Composite Video Out

By connecting a standard video cable to the Composite Video Out, you can view your notebook display on a TV screen. The Composite Video In lets you view and capture motion video or still images from a VCR or video camera. Video capture software programs require windows drivers, which are supplied with your notebook.

To perform the functions described in this section, you need to have a video display program installed.

 **Note:**

Reset your display setting to 640 × 480 resolution with large text fonts for best viewing.

To connect your notebook to a TV

1. Connect one end of a standard video cable to the Composite Video Out on the notebook.
2. Connect the other end of the cable to the Video In connector on your television or VCR.
3. Press FN+F3 to switch to Composite Video Out.

To connect a VCR/Camera to your notebook

1. Connect one end of a standard video cable to the Composite Video In on the notebook.
2. Connect the other end of the cable to the Video Out connector on your VCR or camera.
3. Switch to the TV IN video source by pressing FN+F7.

Using ATI Player

ATI Player is a video capture utility program that lets you display, capture, and edit video (single frame or video stream) from Composite Video In.

To use ATI Player

1. Connect Video Out of your external source, such as a video camera, to the Composite Video In on your notebook.
2. Connect Audio Out of your external source, if available, to the Line In.
3. Press FN+F7 until **TV IN** appears in the VIDEOSRC window in the upper left corner of your screen.
4. Click **Start, Programs, ATI Multimedia**, then **ATI Player**. The program starts. The following information will assist you in getting started.

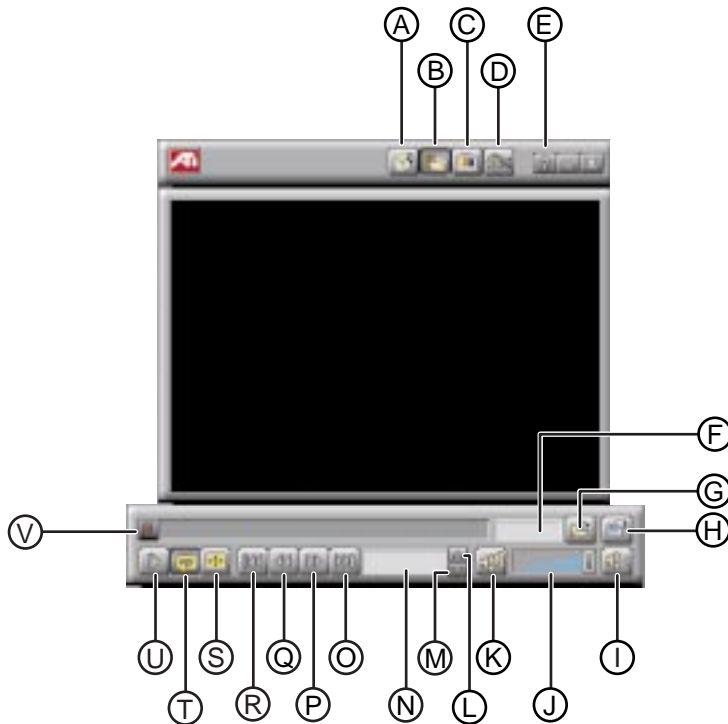

★ Important!

Your notebook configuration does not support Tuner Mode.

Note:

Click the **Help** button (E) for further details on the capabilities of this program.

ATI Player Descriptions

- A. CD Audio mode: Plays standard audio CDs.
- B. MPEG mode: Plays compressed/decompressed video and audio.
- C. TUNER mode: Not supported.
- D. CAPTURE mode: Captures still images from video input and displays full-motion video.
- E. Displays **Help** information.
- F. Displays current file position.
- G. Opens file(s).
- H. Opens setup dialog where you can display player options.
- I. Mutes audio volume.
- J. Controls audio volume.
- K. Selects between audio tracks on dual mode MPEG CDs.
- L. Plays previous track.
- M. Plays next track.
- N. Displays current file name.
- O. Skips to last frame.
- P. Advances to 10 seconds later.
- Q. Returns to 10 seconds before.
- R. Skips to first frame.
- S. Plays full screen video.
- T. Plays current track or playlist repeatedly.
- U. Plays or stops playback.
- V. Slides to randomly search through the file and select a location.



Managing Power Consumption

| | |
|---------------------------------|----|
| Maintaining battery power | 46 |
| Battery learning software | 46 |
| Battery status | 48 |
| Swapping batteries..... | 49 |
| Maximizing battery life | 51 |
| Managing power..... | 52 |
| Windows 98..... | 52 |
| Windows 95 and Windows NT | 55 |
| Using the Power menu | 56 |
| Status menu..... | 58 |

Maintaining battery power

The notebook can run on a fully charged battery for about 3 to 4 hours of normal use before the battery needs recharging.

As long as the AC adapter is properly connected, the battery will charge while your notebook is operating.

Battery learning software

About once a year you will need to run the Battery Learning Software to re-calibrate the battery gauge. This learning cycle increases the battery gauge accuracy (gauge accuracy changes over time).

Because the learning cycle can take as long as 16 hours per battery, we suggest that you let the Learning Cycle program run overnight.

★ *Important!*

Removing the battery or disconnecting the AC power will interrupt the learning cycle. If the learning cycle is interrupted, it must be restarted from the beginning to properly condition the battery.

To perform a learning cycle on the battery pack

1. Insert the battery into the battery bay.
2. Plug the AC adapter into the notebook, then to an AC outlet.
3. Insert the Portable System Restoration CD.
4. Start up your notebook.
5. After pressing the power button, watch for a message to appear on the bottom left side of your screen. This message will prompt you to press F2.
6. Press F2 as soon as the message appears. The BIOS Setup program opens.
7. In the **Main** menu, select **Boot sequence** by pressing the down arrow key.
8. Change the **Boot sequence** value to **CD-ROM** by pressing the (-) minus key.
9. Select the **Exit** menu by pressing the right arrow key.

10. Select **Save Changes & Exit** by pressing ENTER, then press ENTER again.
11. At the next screen, select **Boot from CD-ROM**.
12. Press ENTER. After the program loads memory for approximately 5 to 10 seconds, another screen appears.
13. Select **Go to other options** by pressing the down arrow, then press ENTER.
14. Select **Battery learning...** (of your particular notebook model) by pressing the down arrow.
15. Press ENTER. A screen with a description of the Battery Learning Software appears.
16. Press ENTER.
17. After reading the last screen of instructions, press any key to continue.
18. Type **Y**, then press ENTER. After a couple of minutes, a screen showing the progress of the Battery Learning Software appears.
19. Once the cycle is complete, follow the on-screen instructions.

Battery status

You can check the battery status in several ways.

- ◆ Position the cursor over the power cord or battery icon in the lower right corner of the taskbar. A battery status popup window appears. Moving the cursor anywhere on the display closes the window.
- ◆ Click twice on the power cord or battery icon in the lower right corner of the taskbar. A battery status window opens. Click on the **X** in the upper right corner of the screen to close it.
- ◆ Click on **Start, Settings**, then **Control Panel**. Double click on the **Power Management** icon. You can view the battery status and set power preferences from the **Power Management Properties** window.
- ◆ Press the FN and the F2 keys simultaneously. The Power Status window appears in the upper left corner of the display. This window monitors battery status and the power management selection. BAT1 monitors the status of the battery pack in the battery bay. Press the FN and the F2 (Status) keys again to close the window.

When the battery level gets low:

- ◆ The system beeps three times.
- ◆ The battery icon in the lower right task bar has a red “X” over it.
- ◆ The Low Battery window appears, advising you to change your battery or switch to AC power immediately to prevent losing your work. Connect the AC adapter to the notebook to recharge the battery.

Swapping batteries

Battery packs can be “warm-swapped.” This means that you can change battery packs while in Standby mode.

To replace the battery pack

1. Save all work.
2. Press the FN and the F4 keys simultaneously. The notebook goes into Standby mode.
3. Close the cover and turn your notebook over.
4. Slide the battery release latch toward the center of the notebook.
5. Hold the latch in its release position and place your fingers over the raised bar on the battery pack next to the latch.



6. Slide the battery pack straight out and away from your notebook, then release the battery release latch.

★ Important!

Since notebooks only operate in Standby mode for a short time without power, battery swapping should be done quickly.

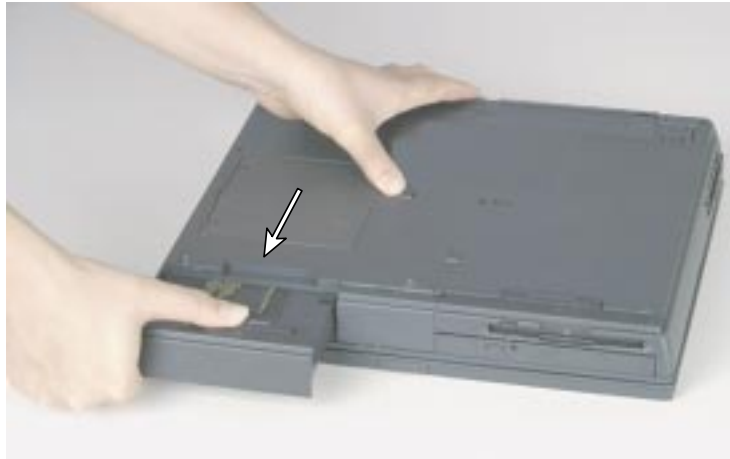

- 7.** Slide a recharged battery pack (bottom side up) straight into the battery bay until it snaps into place.
- 8.** Turn the notebook right side up and open the cover.
- 9.** Press the power button. The notebook resumes power.

Maximizing battery life

You can extend the battery life by following these practices:

- ◆ Dim the display brightness as low as is comfortable.
- ◆ Close the LCD lid when not in use. The LCD display stays off until you open the lid.
- ◆ If your PC Card uses battery power even when not in use, remove the card between uses. Check the PC Card manufacturer's documentation for your card's power requirements.
- ◆ Keep the battery pack in the computer when using AC power to continuously charge the battery.
- ◆ Use the DVD or CD-ROM only when necessary. (Both of these drives use a large amount of battery power.)

See "Managing power" on page 52 for more information about changing the power management settings in Windows 98.

See "Using the Power menu" on page 56 for more information about accessing the Power menu settings in the BIOS Setup program for Windows 95 and Windows NT.

Managing power

Power management is handled differently in Windows 98 than in Windows 95 and Windows NT. The following sections address these differences. Refer to the section that applies to your operating system.

Windows 98

To manage your power management settings in Windows 98, you do not need to open the BIOS Setup program. This is only necessary if you want to change the power button setting. Instead, Windows 98 includes a Power Management Properties dialog box.

To use the Power Management Properties

1. Click **Start, Settings, then Control Panel**.
2. In the Control Panel window, double-click the **Power Management** icon. The **Power Management Properties** dialog box appears.



3. Click the appropriate tab to view and modify settings.

Creating power schemes

The **Portables/Laptop** power scheme changes the settings to maximize the battery life of your notebook.

You can select one of three pre-defined power schemes from the **Power schemes** drop-down list.

You can also create your own power scheme and add it to the list.

To create a power scheme

1. Click on **Start, Settings**, then **Control Panel**.
2. Double-click the **Power Management** icon. The Power Management Properties window appears.
3. Click to select the Power Schemes tab.
4. Set the properties as you want them to be in your power scheme, then click **Save As**.
5. Type a name for your power scheme, then click **OK**.
6. Select your power scheme from the **Power scheme** drop-down list.
7. Click **OK** to apply the change.

Alarm settings

Your notebook is equipped with alarms that can alert you if your battery power is running low.

An Alarms tab is located in your Power Management Properties dialog box. You can turn the alarms on and off, set the time when your notebook alerts you of a low battery, then select how you want to be notified.

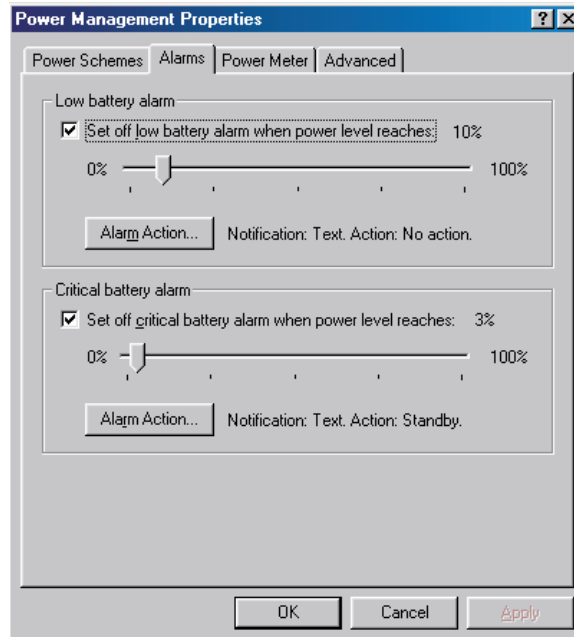

Using Standby mode in Windows 98

Windows 98 uses Standby mode (which is referred to as Suspend mode in Windows 95). When in Standby mode, your notebook enters a sleep state, cutting off power to most devices except memory.

The following table shows how to change the system modes in Windows 98.

| If your notebook is... | ...and you want to... | ...then do this |
|------------------------|-----------------------|---|
| Off | Start up | Press the power button. |
| On | Standby | Click Start, Shut Down, Standby , then click OK . - OR - Press FN+F4. |
| In Standby mode | Resume power | Press the power button briefly. |
| On | Shut down | Click Start, Shut Down , click Shut Down again, then click OK . |

Windows 95 and Windows NT

To manage your power management settings in Windows 95 and Windows NT, you need to go into the BIOS Setup program and change the power management settings. See “Using the Power menu” on page 56 for more information on these settings and how to modify them.

Using Suspend mode in Windows 95 and Windows NT

Windows 95 and Windows NT use Suspend mode (which is referred to as Standby mode in Windows 98). When in Suspend mode, your notebook enters a sleep state according to the power management settings. Suspend mode cuts off power from most devices except memory.

The following table shows how to change the system modes in Windows 95 and Windows NT.

| If your notebook is... | ...and you want to... | then do this |
|------------------------|-----------------------|---|
| Off | Start up | Press the power button. |
| On | Suspend | Click Start , then Suspend . |
| In Suspend mode | Resume power | Press the power button briefly. |
| On | Shut down | Click Start , Shut Down , Shut down the computer , then click Yes . |

Using the Power menu

The Power menu is a part of the BIOS Setup Utility that contains the power management settings. Use the Power menu to make changes to the notebook to improve the battery-powered session time and performance. The rest of the BIOS Setup screens are explained in *Maintaining and Troubleshooting Your Solo Notebook*.

To access the Power menu

1. Start your notebook.
2. Press the F2 key when prompted to do so.

- The “Entering Setup...” message appears briefly and then the Main menu appears.

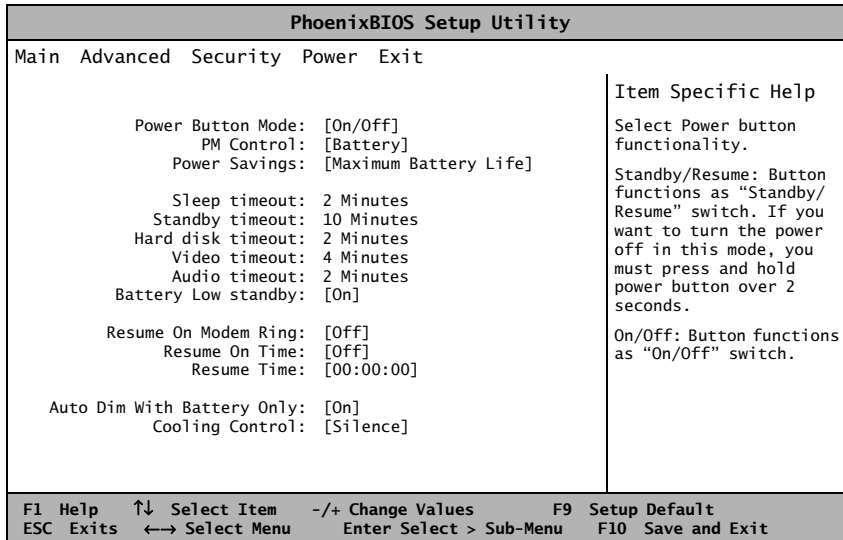

- Use the keys identified at the bottom of the screen to navigate through the various options. An Item Specific Help bar providing additional information is also located to the right of each menu.

This screen example is similar to what you see on your LCD. However, you may have a notebook with a newer BIOS version than the one described in this manual. If there are differences, see the information in the Item Specific Help box in the right column of the BIOS Setup menu.

★ *Important!*

In Windows 98™, Microsoft® has replaced the term “Suspend” with “Standby.”

Standby is used when referring to Windows 98™ and Suspend is used when referring to Windows 95™.

★ *Important!*

Changes in power management levels are temporary and do not affect the power settings in the BIOS setup screens. The changes are only in effect until the notebook is restarted, then the BIOS power settings are restored.

The following settings are most commonly changed:

- ◆ **Power button mode** sets power switch functionality. When you press the power button, the notebook can be set to either Shut Down or Standby. Press the spacebar to select **On/Off** or **Standby/Resume**.
- ◆ **PM Control** provides preset or customized power management.
 - Setting this option to **Maximum Performance** gives the best system performance.
 - Setting this option to **Maximum Battery Life** gives the best battery performance.
 - Setting this option to **Customize** lets you manually set the **Standby**, **Hard disk**, and **Video timeouts**. Press the spacebar to choose between options.
- ◆ **Auto dim with battery** decreases the LCD brightness 50% when using battery power only. Press the spacebar to select **On** or **Off**.

Status menu

The **Status** menu is supported by the VGA controller chip. The menu opens in the upper left corner and closes after about 30 seconds.

- ◆ **Power status display** appears when you press the FN key together with the F2 (Status). It shows current battery status. The display is updated when you change any function choice.
- ◆ **Battery status** appears in the top two lines. The first line reflects the status of the primary battery pack. The second line reflects the status of the optional secondary battery.

The power management levels appear in the third and fourth lines. You can change power management levels during setup.

AC power status is monitored on the fifth line.

- ◆ **The Brightness meter** shows the brightness level for the LCD panel. Press the FN key simultaneously with the up arrow or down arrow key to increase or decrease the brightness level.



Getting Online

| | |
|-----------------------------------|----|
| Using the Internet | 60 |
| Using e-mail..... | 61 |
| Sending e-mail..... | 62 |
| Checking your e-mail..... | 63 |
| Exploring the World Wide Web..... | 65 |
| Using Microsoft Fax..... | 67 |
| Setting up Microsoft Fax..... | 67 |
| Sending and receiving faxes | 69 |



Using the Internet

The Internet is a worldwide network of computers linked together to provide information to users everywhere. You can access this global network by connecting your computer to a normal phone line and signing up with an Internet service provider. Internet services include e-mail and the World Wide Web.

E-mail (electronic mail) lets you send messages to anyone in the world, as long as you and the recipient both have Internet connections and e-mail addresses.

The World Wide Web is a user-friendly interface to the Internet that gives you point-and-click access to millions of sources of information. Almost everything is available for download, including pictures, sounds, and programs.

To begin your journey through the Internet you need:

- ◆ **Modem** — a device installed in the computer that connects the computer to a phone line. Your Solo 9150 notebook has a built-in 56K data/fax/voice modem.
- ◆ **Internet service provider (ISP)** — a connection between the modem and the Internet, such as gateway.net.
- ◆ **Web browser** — an application that translates information from the Internet service provider to the computer. The Microsoft® Internet Explorer™ Web browser is already installed on your notebook.

To understand Internet functions, you should know the following terms:

- ◆ **Electronic mail (E-mail)** — messages transmitted by telephone lines.
- ◆ **E-mail address** — an Internet address to which e-mail can be sent. This address designates a location on the Internet that messages and files can be sent to.
- ◆ **Downloading** — transferring a copy of a file from a remote server (see definition on following page) or computer to your computer's hard drive.
- ◆ **Link** — a word or image within a Web page on which you can click to go to another Web page or access additional information.

Note:

For more information on modems, see "Connecting the modem" on page 28.

★ Important!

Downloading (receiving files from the Internet) is not always fast. Sometimes large files and slow connection speeds contribute to slow downloading.

- ◆ **Home page** — a file that appears after connection has been made to a Web site address. This page contains links that will guide you throughout the Web site and may link you to other Web sites.
- ◆ **Server** — a computer or computer program that saves data in a storage area. This data can be downloaded to your computer for manipulation or printing purposes.

Using e-mail

You can send *e-mail* (electronic mail) over the Internet to anyone on the Internet with an e-mail address.

Sending e-mail requires no postage or other additional fees — it is a free service of your Internet account. And, because the Internet never “closes,” you can send e-mail messages at any time of the day or night. Your e-mail arrives at most Internet e-mail addresses in minutes.

An *e-mail address* consists of a user name, the @ symbol, and the “domain name” of the ISP or company that “hosts” that user. Your e-mail address is assigned when you sign up for an account with an ISP. For example, a person with an account with the gateway.net ISP might have this e-mail address:

jdoe@gateway.net

which is...

User name at Internet domain name

The domain name of gateway.net ISP users ends with .net (to designate a network-oriented host). However, other Internet domain names may have other suffixes such as .com (mostly US commercial hosts), .edu (US educational hosts), .org (organizations), or .gov (US government). Regardless of the Internet domain name, the steps in sending and receiving e-mail are the same.

Sending e-mail

If you have signed up for an account with the gateway.net Internet access service, your e-mail is set up and ready to use.

To send e-mail

★ *Important!*

These instructions are specific to the gateway.net Internet access service.

If you have an account with a different Internet Service Provider, or are using a different e-mail application, refer to the documentation from that ISP or software manufacturer.

1. Log on to your gateway.net account (or other ISP account).

After the computer connects, the Web browser opens. (If you are using another ISP, start your Web browser.)

2. From the Web browser start your e-mail application:

- If you use the Microsoft Internet Explorer Web browser, click **Go**, then **Mail**. This opens the Microsoft Outlook Express e-mail application.
- If you use the Netscape Navigator Web browser, click **Communicator**, then **Messenger Mailbox**. This opens the Netscape Messenger e-mail application.

3. Open a new message window:

- If you use the Microsoft Outlook Express e-mail application, click **Compose**, then **New Message**.
- If you use the Netscape Messenger e-mail application, click **Message**, then **New Message**.

4. In the new message window type the e-mail address of the person you want to send your message to in the **To:** field (if you have multiple e-mail addresses, separate them with semicolons), then type in the **Subject:** and your message.

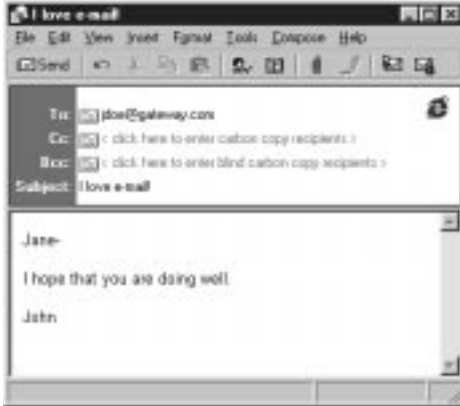

New Message window in Microsoft Outlook Express

5. Click Send.

After the message has been sent, you can close your e-mail and Web browser applications and disconnect from your Internet service.

The e-mail is routed over the Internet and, after a few minutes (or longer, depending upon Internet conditions), it arrives at the recipient's e-mail account.

Because your e-mail address is contained in your message, the recipient only needs to click a "reply" button to respond to your e-mail.

Checking your e-mail

For you to receive e-mail, someone must first send an e-mail to your e-mail address. (If you have an account with the gateway.net ISP, your address is your user name at gateway.net, for example, jdoe@gateway.net.)

When someone sends an e-mail to you, it arrives at your e-mail account on a gateway.net computer usually within minutes (depending upon Internet conditions).

To check your e-mail

1. Log on to your gateway.net account (or other ISP account).

★ *Important!*

These instructions are specific to the gateway.net Internet access service.

If you have an account with another Internet Service Provider, or are using another e-mail application, refer to the documentation from that ISP or software manufacturer.

After your computer has connected, the Web browser opens. (If you are using another ISP, start your Web browser.)

2. Start your e-mail application:

- If you are using the Microsoft Internet Explorer Web browser, click **Go**, then **Mail**. This opens the Microsoft Outlook Express e-mail application.
- If you are using the Netscape Navigator Web browser, click **Communicator**, then **Messenger Mailbox**. This opens the Netscape Messenger e-mail application.

3. Check for new messages:

- If you are using the Microsoft Outlook Express e-mail application, click **Tools**, then **Send and Receive**.
- If you are using the Netscape Messenger e-mail application, click **File**, **Get Messages**, then **New**.

If you have new e-mail, it is downloaded to your computer and displayed in your e-mail inbox.

4. To read a message, double-click it.

The message opens.

After you have received your e-mail messages, they remain on your computer until you delete them. (For information about deleting a message, see your e-mail application's online help.) Also, you do not need to be connected to the Internet to read messages that you have already received.

Exploring the World Wide Web

Once your Internet service is set up, you are ready to explore the Internet. To do this, you need to use a Web browser. In our example below we use Microsoft Internet Explorer to visit the Gateway Web site.

To browse the World Wide Web

1. Connect to the Internet service. Depending upon your Internet service provider, you may be prompted to provide your user ID and password.
2. Double-click the **Internet Explorer** icon on the desktop. Microsoft Internet Explorer opens.
3. Go to a Web site by typing its address in the browser's address bar (for example, <http://www.gateway.com>) then pressing ENTER.

★ *Important!*

Web site addresses are not always permanent. If an error screen appears that states the file cannot be found, verify that you have typed the correct address. If a screen stating the file cannot be found appears again, the Web site has either changed location or no longer exists.

The Web browser locates the site, downloads the text and graphics to the computer, and displays the site in the browser window. In the following illustration, the Gateway Web site appears in Microsoft Internet Explorer.

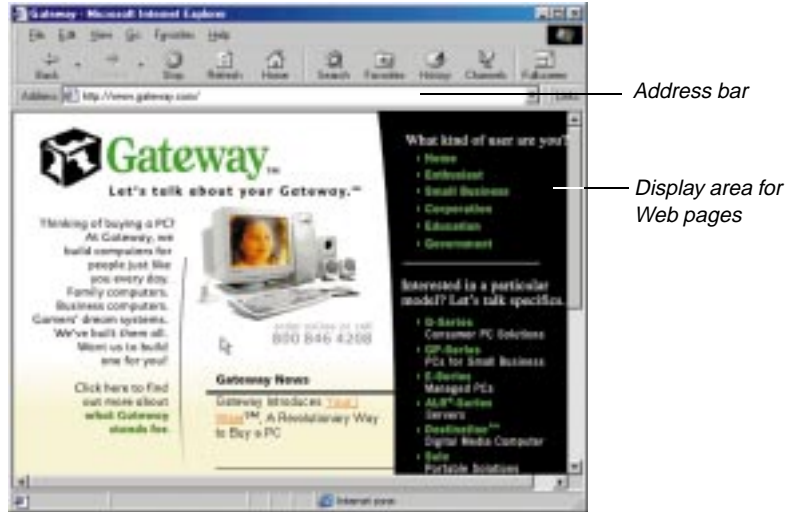

When you move the cursor over the screen and it changes to a hand, you can click to link to another page or section of the Web site.

Refer to the Web browser's online help to learn more about using the Web browser, exploring the Web, and printing and saving information.

Using Microsoft Fax

To fax documents with Windows 98 and Windows 95, we recommend using Microsoft Fax, which is available in both operating systems.

Setting up Microsoft Fax

Although Windows 98 and Windows 95 look very similar, the setup required for Microsoft Fax is different for each operating system.

To set up Microsoft Fax in Windows 95

1. Double-click the **My Computer** icon on your desktop, then click **Control Panel**. The Control Panel appears.
2. Click **Add/Remove Programs**, then click the **Windows Setup** tab.
3. If it is not already selected, click to select the **Microsoft Fax** check box. If the check box is already selected, exit **Add/Remove Programs** and stop here. If a message asks you to include all required components, click **Yes** and go to next step.
4. Click **OK** at the bottom of the **Add/Remove Programs** window. If the Inbox Setup Wizard appears, go to Step 5. If the Inbox Setup Wizard does not appear, follow the instructions on the screen.
5. In the Inbox Setup Wizard, click the **Properties** button and make sure your active modem is selected. If the wizard prompts you for mail information you do not have, click **Cancel** to exit the wizard, then restart the wizard and clear the check boxes for **Microsoft Mail** and **Internet Mail**.
6. The default Answer mode is **Don't Answer**. If another program uses the same COM port as your modem, keep the default setting. Otherwise, change the Answer mode to either **Manual** or **Answer After**. Select **Manual** if you will use your phone line for voice calls or other programs. If you will use your modem only for faxing, choose **Answer After**. Click **OK** to save changes.

7. Click to indicate whether you want Microsoft Fax to answer all incoming calls, then click **Next**.
8. Fill in your personal and phone line information, then click **Next**.
9. If you chose to install Microsoft Mail, enter the path to your Post Office, which you can get from a server administrator.
10. If you chose to install Internet Mail, enter the information requested in the next few windows.
11. If this is your first Microsoft Fax installation, select the default path for Personal Address Book by clicking **Next**.
12. Choose whether you want Microsoft Exchange to automatically run when you start Windows 95. Remember that you need to have Microsoft Exchange running to receive faxes. Click **Next**.
13. Click **Finish**. Microsoft Exchange opens. If the Mail logon dialog box appears and states that you do not have a post office set up, click **Offline**. You will still be able to use Microsoft Fax.

To set up Microsoft Fax in Windows 98

1. Insert the Windows 98 CD into your DVD or CD drive.
2. Double-click on the DVD or CD icon in Microsoft Windows Explorer, then open the folder `\tools\oldwin95\message\us\`.
3. Double-click the file **wms.exe**, then follow the Windows Messaging installation instructions.
4. After Windows Messaging is installed, double-click the file **awfax.exe** and follow the Microsoft Fax instructions.

Sending and receiving faxes

To send a fax

To send a fax using the Start button:

1. Click the **Start**, **Programs**, then **Accessories**.
2. Click **Fax**, then click **Compose New Fax**. The Compose New Fax Wizard opens to guide you in preparing your fax. Follow the instructions on the screen.

- OR -

To send a fax using Microsoft Exchange:

1. Double-click the **Inbox** icon to run Microsoft Exchange.
2. Click the **Compose** menu, then click **New Fax**. Follow the instructions in the Compose New Fax Wizard.

- OR -

To send a fax by printing to Microsoft Fax:

1. Open the document that you want to fax (for example, a Microsoft Word document).
2. Select the **File** menu, then click **Print**.
3. Select **Microsoft Fax** from the list of printers, then click **OK**. Follow the instructions in the Compose New Fax Wizard.

To receive, view, and print a fax

1. Double-click the **Inbox** icon. Microsoft Exchange opens.
2. If you have already changed the Answer Mode to **Answer After** or **Manual** go to Step 8. Otherwise, go to the next step.
3. Click the **Tools** menu, **Microsoft Fax Tools**, then **Options**. The **Microsoft Fax Properties** window appears.

4. Click the Modem tab in the Microsoft Fax Properties window.
5. Click the **Properties** button and make sure your active modem is selected. (The default Answer mode is **Don't Answer**.)

If another program uses the same COM port as your modem, keep the default setting. Otherwise, you must change the Answer mode to be able to receive faxes.

6. If you will use your phone line for voice calls or other programs, select **Manual**.

- OR -

7. If you will use your modem only for faxing, select **Answer After**.
8. Click **OK** to save changes.
9. Close the Microsoft Fax Properties window, but leave Microsoft Exchange open to receive faxes. You are notified when a fax arrives.
10. After a fax is received, click the **Inbox** folder in the Personal Folders window, then double-click the first fax in the list. The fax document opens in the FaxViewer.
11. Click **Print** to print the fax.



Solo Notebook Accessories



Accessories

We offer many accessories that can help you make the most of using your Solo notebook. Check out our web site or call our Add Ons group to find products that will best fit your needs.

The **Docking station** is a full-featured expansion unit designed for mobile users who require the modularity and functionality of a desktop system. The docking station's key features include two dual expansion slots (PCI or ISA), a 3.5" hard drive expansion bay, a 5.25" or 3.5" device expansion bay, two PC Card slots, built-in stereo speakers, and a removable monitor stand.

Other features are the MIDI/game port and two PS/2 ports. These ports give you the capability to attach such peripheral devices as a mouse, joystick, or an external keyboard to the docking station. Once you connect the peripherals, you can leave them attached for the next use.

The **Mini-docking station** enhances the capabilities of your Solo notebook by providing a connection to external devices such as a monitor, keyboard, mouse, printer, serial device, joystick, external power, speakers, and microphone. This docking station provides additional PC Card slots for expanded functionality when using network cards, SCSI adapters, and modems.

The **extra battery pack** provides power when you're on the road and cannot use the AC power adapter.

The **battery charger** charges your notebook's battery packs. It takes approximately two to three hours to charge a fully discharged battery. This battery charger has two LEDs to indicate battery charge status.

The **automobile/airplane adapter** provides a safe and easy way to plug your notebook into industry-standard EmPower in-seat power receptacles. These receptacles can be found on major airlines, cars, boats, or recreation vehicles.

Accessories such as memory modules, external keyboards, speakers, carrying cases, printers, tape backup units, hard drives, modems, network cards, software, and uninterruptable power supplies (UPS) are also available.

 **Note:**

For more information on this or other Gateway accessories for your notebook, visit our website at www.gateway.com or call (800) 846-2000.



Contacting Gateway

Contacting Gateway

If you have any trouble while using your Gateway Solo Multimedia Notebook, please contact Gateway. You will need to supply your Client ID, serial number, and order number to the customer support technicians. Your Client ID number and order number can be found on your invoice. The serial number can be found on the bottom of your notebook. Make a note of these numbers here.

Client ID: _____

Serial Number: _____

Order Number: _____

If your computer is ever stolen, be sure to contact your local police and a Gateway representative at once. We will put a note on the account so that if anyone calls trying to use your notebook serial number, we will contact you immediately.

Gateway offers a wide range of customer service, technical support, and information services. If you have questions or problems, contact the Gateway service that is most appropriate.

| For assistance or information about: | Contact: | At: |
|---|--|---|
| Systems, pricing, orders, billing statements, warranty service, and other non-technical issues. | Sales & client support: If outside the US, check your warranty booklet for numbers | 800-846-2000 |
| Problems with hardware or software. | Portables technical support: US - toll free Canada - toll free | 800-846-2302 800-846-3609 |
| The Gateway Web site which contains a variety of information about Gateway. (Modem required.) | World Wide Web: US and Canada | http://www.gateway.com |

Index

A

- AC connector 12
 - power 14
- accessories
 - notebook 72
- address bar 65
- answer mode 67, 69
 - answer after 67
 - manual 67
- applications
 - e-mail 62
 - key 19
 - Microsoft Internet Explorer 65
 - Web browser 65
- arrow down 18
- arrow up 18
- assistance resources 74
- ATI player 42
- audio
 - connectors 41
 - Dolby Digital Out 9
 - Line In 8
 - Line Out 9
 - speakers 5
- audio recording
 - creating 31, 33
- auto dim with battery 15, 58
- automobile/airline adapter 72

B

- back ports cover 11
- battery 46, 72
 - charger 72
 - gauge 46
 - latch 11
 - maintaining 46
 - status 48
- battery learning
 - software 46
- battery LED 5

- battery life
 - maximizing 51
- battery pack
 - bay 11
 - replacing 49
- battery status 58
- BIOS setup utility 57
- brightness 18
- browser 60
- button
 - eject 7
 - power 5, 15
 - reset 11

C

- calling Gateway 72, 74
- Caps lock 6
- CardBus 39, 40, 75
- CD-ROM
 - drive 5
 - playing 35
- charging
 - battery pack 48
- client ID 74
- combination module 11
- composite video (TV) 41
- connecting
 - AC power 14
 - modem 7
- contacting Gateway 72, 74

D

- data modem 60
- decrease
 - LCD brightness 18
- display 5, 15
 - TV 17
- display type 11
- docking station 72
- docking station port 9
- Dolby Digital Out 9

- downloading 60
- drive
 - 120 MB SuperDisk 5
 - CD-ROM 5
 - combination 5, 11
 - diskette 5
 - DVD 5
 - hard disk 5
- DVD
 - drive 5
 - playing 34
- E**
- eject buttons 7
- e-mail 60
 - checking 63
 - introduction 61
 - sending 62
- e-mail address 60
- external
 - headphones 9
 - microphone 8
 - monitor 5, 15
 - mouse 27
 - speakers 9
- EZ-Pad
 - touchpad 5, 20
 - touchpad properties 25
- EZ-Point
 - stickpoint 5, 26
 - stickpoint properties 27
- F**
- F10 18
- F11 18
- F12 18
- F2 17
- F3 17
- F4 17
- F7 17
- F9 18
- Fast IR port 8, 40
- fax modem 60

- faxes
 - printing 69
 - receiving 69
 - viewing 69
- flip foot 11
- function keys 16
 - pad lock 18
 - pause 18
 - scroll lock 18

G

- Gateway
 - contacting 74
- Gateway Web site 65
- gateway.net
 - checking e-mail 63
 - sending e-mail 62

H

- hard drive 5, 37
 - access cover 5
 - access light 6
 - removing 37
 - replacing 37
- home page 61
- <http://www.gateway.com> (US site) 74
- hyperlink 60

I

- increase
 - LCD brightness 18
- indicator 6
 - Caps lock 6
 - CD/diskette drive 6
 - DVD/120 MB drive 6
 - hard drive access light 6
 - Pad lock 6
 - system status 5
- infrared port 8, 40
- inserting PC cards 39
- Internet 60
 - e-mail 60, 61, 62, 63
 - Gateway Web site 65
 - World Wide Web 65

Internet Explorer 60, 65
Internet service provider 60
ISP 60

J

jack
 modem 7
 speaker out/headphone 9
joystick/MIDI port 8

K

Kensington lock slot 12
keyboard 5, 16, 17
keypad 18
keys
 application 19
 break 18
 F10 18
 F11 18
 F12 18
 F2 17
 F3 17
 F4 17
 F7 17
 F9 18
 Fn 17
 function 16
 pad lock 19
 shortcut 16
 special 19
 Windows 19

L

LCD 5, 15
 brightness 18, 58
LED
 battery 5
 power 5
lid switch
 on/off 58
 standby/resume 58
 suspend/resume 58
Line In 8
Line Out 9

link 60
lock slot
 Kensington 12
LPT1 9

M

managing power 52
manual answer mode 67
maximizing
 battery life 51
Mic 8
Microsoft Exchange 68, 69
Microsoft Fax
 setting up 67
MIDI
 In 8
 Out 8
mini-docking station 72
mode
 answer 67
 battery status 5, 58
 power status 5, 58
 standby 55
 suspend 55
 system status 5, 56
model number 11
modem 7, 60
monitor 5
 external 17
 TV display 17
mouse
 external 27
mousepad 20

N

notebook
 accessories 72
numeric keypad 16, 18, 19

O

on/off mode 58
order number 74

P

- Pad lock 6
- pad lock
 - function keys 18, 19
- parallel port 9
- password 65
- pause
 - function key 18
- PC Card
 - 32 Card 40
 - eject buttons 7
 - inserting 39
 - removing 39
 - slots 7
 - using 39, 75
- phone line jack 7
- playing
 - CD-ROM 31
 - DVD 34
- pointing device
 - EZ-Pad touchpad 5
 - EZ-Point stickpoint 5
- pop-up status display 17
- portables technical support 74
- ports
 - docking station 9
 - Fast IR 8, 40
 - joystick/MIDI 8
 - parallel (LPT1) 9
 - PS/2 9
 - serial 9
 - Universal Serial Bus (USB) 12
- post office 68
- power
 - button 5, 15
 - LCD 15
 - LED 5
- power button 56
- power button mode 58
- power connector 12

- power management 52
 - Windows 95 55
 - Windows 98 52
 - Windows NT 55
- power menu 56
- power schemes 53
- power status 58
- printing faxes 69
- processor speed 11
- properties
 - stickpoint 27
 - touchpad 25
- PS/2 port 9

R

- receiving faxes 69
- removing
 - battery 11
 - combination modules 30
 - hard disk drive 37
 - PC Cards 39
- replacing
 - batteries 49
 - combination modules 31
 - hard disk 37
- reset switch 11

S

- sales & customer support 74
- Scroll lock 6
- scroll lock
 - function key 18
- serial number 11, 74
- serial port 9
- server 61
- setting
 - alarm 54
 - power button 56
 - standby/resume 56
- shortcut keys 16
- shutdown
 - Windows 98 55
- software
 - battery learning 46

- speaker out/headphone jack 9
- speakers 5
 - volume 7
- special keys 19
- standby mode 17, 55
- standby/resume 15
 - lid switch 58
- status
 - batteries 48
 - menu 58
- stickpoint 5
 - customizing 27
 - properties 27
- suspend mode 55
- suspend/resume
 - power button 58
- system
 - identification 11
- system status indicators 5

T

- technical support 74
- touchpad 5, 20
 - customizing 25
 - properties 25

U

- Universal Serial Bus (USB) ports 12, 40
- user ID 65
- using
 - EZ Point 26
 - Fast IR port 40
 - keyboard 27
 - mouse 27
 - PC Cards 39, 75
 - touchpad 20

V

- VGA 9
- video
 - capture 42
 - In 8, 42
 - Out 8, 42
 - ports 41
 - source 17
- viewing faxes 69
- volume wheel 7

W

- Web
 - browser 65
 - See also* World Wide Web
- Windows
 - key 19
- Windows 95
 - power management 55
 - suspend mode 55
- Windows 98
 - power management 52
 - standby mode 55
- Windows Messaging 68
- Windows NT
 - power management 55
 - suspend mode 55
- World Wide Web 60, 65

Z

- zoomed video 39, 75

Regulatory Compliance Statements

American Users:



This device has been tested and found to comply with the limits for a Class B digital device, pursuant to Part 15 of the FCC rules. These limits are designed to provide reasonable protection against harmful interference in a residential installation. This equipment generates, uses and can radiate radio frequency energy and, if not installed and used in accordance with the instructions, may cause harmful interference to radio or television reception. However, there is no guarantee that interference will not occur in a particular installation. If this equipment does cause interference to radio and television reception, which can be determined by turning the equipment off and on, the user is encouraged to try to correct the interference by one or more of the following measures:

- ◆ Reorient or relocate the receiving antenna
- ◆ Increase the separation between the equipment and receiver
- ◆ Connect the equipment into an outlet on a circuit different from that to which the receiver is connected
- ◆ Consult the dealer or an experienced radio/TV technician for help.

Accessories: This equipment has been tested and found to comply with the limits of a Class B digital device. The accessory associated with this equipment is the shielded power cord.

This accessory is required to be used in order to ensure compliance with FCC rules.

This digital apparatus does not exceed the Class B limits for radio noise emissions from digital apparatus as set out in the radio interference regulations of Industry Canada.

Le présent appareil numérique n'émet pas de bruits radioélectriques dépassant les limites applicables aux appareils numériques de Classe B prescrites dans le règlement sur le brouillage radioélectrique édicté par Industrie Canada

Attention!

Couper le courant avant l'entretien.

Caution!

The Federal Communications Commission warns the users that changes or modifications to the unit not expressly approved by the party responsible for compliance could void the user's authority to operate the equipment.

Canadian Users:



This Information Technology Equipment has been tested and found to comply with the following European directives:

[i]EMC Directive 89/336/EEC amending directive 92/31/EEC & 93/68/EEC as per

- EN 50081-1:1992 according to
EN 55022:1995 Class B
EN 61000-3-2:1995 or EN 60555-2:1986
EN 61000-3-3: 1995
- EN50082-1:1992 according to
EN 61000-4-2:1995 or IEC 801-2:1984
ENV 50140:1994 or IEC 801-3:1984
EN 61000-4-4:1988 or IEC 801-4:1998

[ii]Low Voltage Directive (Safety) 73/23/EEC as per EN 60950: 1992

This equipment is in the Class 2 category (Information Technology Equipment to be used in a residential area or an adjacent area thereto) and conforms to the standards set by the Voluntary Control Council for Interference by Information Technology Equipment aimed at preventing radio interference in such residential area.

When used near a radio or TV receiver, it may become the cause of radio interference. Read instructions for correct handling.

電波障害について

この装置は、情報処理装置等電波障害自主規制協議会（VCCI）の基準に基づく第二種情報技術装置です。この装置は、家庭環境で使用することを目的としていますが、この装置をラジオやテレビジョン受信器に近接してご使用になると、受信障害を引き起こすことがあります。

取扱説明書に従って正しい取り扱いをしてください。

This device has been tested and found to comply with the limits for a Class B digital device, pursuant to the Australian/New Zealand standard AS/NZS 3548 set out by the Spectrum Management Agency.

Caution!

Disconnect power before servicing.

European Users:



Japanese Users:



Australian and New Zealand Users:



Regulatory Compliance Statements

FCC Part 68

This modem complies with the FCC, Part 68 Rules and Regulations.

The telephone company may request the following information:

- The ringer equivalence number*
- The FCC Registration number*

*This information is printed on the FCC label provided on the bottom of your notebook.

Note:

The Ringer Equivalence Number (REN) is used to determine the quantity of devices which may be connected to the telephone line. Excessive REN's on the telephone line may result in the devices not ringing in response to an incoming call. In most, but not all areas, the sum of the REN's should not exceed five (5.0). To be certain of the number of devices that may be connected to the line, as determined by the total REN's, contact the telephone company to determine the maximum REN for your area.

If the modem malfunctions, disconnect it from the telephone line until the problem is corrected. If you do not disconnect the modem and correct the problem, the telephone company may temporarily disconnect your service.

The telephone company must notify you if it makes changes to the telephone line that would affect the modem in any way. If advance notice is not practical, the phone company will contact you as soon as possible. Also, you will be advised of your rights to file a complaint with the FCC if you believe it is necessary.

Do not connect this modem to a coin telephone line or party line.

This modem uses the following USOC jacks:

- US: RJ-11C
- CANADA: CA11A

If you have any problems, contact Gateway Client Care.

Notices

Copyright © 1999 Gateway 2000, Inc.
All Rights Reserved
610 Gateway Drive
N. Sioux City, SD 57049 USA

All Rights Reserved

This publication is protected by copyright and all rights are reserved. No part of it may be reproduced or transmitted by any means or in any form, without prior consent in writing from Gateway 2000.

The information in this manual has been carefully checked and is believed to be accurate. However, changes are made periodically. These changes are incorporated in newer publication editions. Gateway 2000 may improve and/or change products described in this publication at any time. Due to continuing system improvements, Gateway 2000 is not responsible for inaccurate information which may appear in this manual. For the latest product updates, consult the Gateway 2000 web site at www.gateway.com. In no event will Gateway 2000 be liable for direct, indirect, special, exemplary, incidental, or consequential damages resulting from any defect or omission in this manual, even if advised of the possibility of such damages.

In the interest of continued product development, Gateway 2000 reserves the right to make improvements in this manual and the products it describes at any time, without notices or obligation.

Trademark Acknowledgments

AnyKey, black-and-white spot design, CrystalScan, Destination, EZ Pad, EZ Point, Field Mouse, Solo, TelePath, Vivitron, stylized "G" design, and "You've got a friend in the business" slogan are registered trademarks and GATEWAY, Gateway Solo, green stylized GATEWAY, green stylized Gateway logo, and the black-and-white spotted box logo are trademarks of Gateway 2000, Inc. Intel, Intel Inside logo, and Pentium are registered trademarks and MMX is a trademark of Intel Corporation. Microsoft, MS, MS-DOS, and Windows are trademarks or registered trademarks of Microsoft Corporation. All other product names mentioned herein are used for identification purposes only, and may be the trademarks or registered trademarks of their respective companies.

Copyright © 1999 Advanced Logic Research, Inc. (ALR)
All Rights Reserved
9401 Jeronimo
Irvine, CA 92618 USA

All Rights Reserved

This publication is protected by copyright and all rights are reserved. No part of it may be reproduced or transmitted by any means or in any form, without prior consent in writing from ALR.

The information in this manual has been carefully checked and is believed to be accurate. However, changes are made periodically. These changes are incorporated in newer publication editions. ALR may improve and/or change products described in this publication at any time. Due to continuing system improvements, ALR is not responsible for inaccurate information which may appear in this manual. For the latest product updates, consult the ALR web site at www.alr.com. In no event will ALR be liable for direct, indirect, special, exemplary, incidental, or consequential damages resulting from any defect or omission in this manual, even if advised of the possibility of such damages.

In the interest of continued product development, ALR reserves the right to make improvements in this manual and the products it describes at any time, without notices or obligation.

Trademark Acknowledgments

ALR is a registered trademark of Advanced Logic Research, Inc. All other product names mentioned herein are used for identification purposes only, and may be the trademarks or registered trademarks of their respective companies.

