

EPSON®

ActionNote™ 890 Series

User's Guide



Printed on recycled paper with at least 10% post consumer content

ActionNote 890 Series Update

This update sheet contains additional information about your computer.

Upgrading the Memory

Your system comes with 8MB RAM. In this system's configuration, 4MB is on the system board and 4MB is on a separate memory module inserted in the memory module socket. To upgrade memory, you have to remove the 4MB memory module from the socket and replace it with a larger capacity memory module.

The maximum memory for this computer is 24MB. Use this table to determine the size of the memory module you need to buy. For information on how to replace a memory module, see Chapter 5 of your User's Guide.

You want to upgrade to	Memory module size to buy
12MB	8MB
20MB	16MB
24MB	20MB

PC Card Software

We have provided SystemSoft® CardSoft and Card Wizard drivers and utilities for you to use if you select MS-DOS® and Windows®3.11 as your operating system. If you select Windows 95 as your operating system, you can use the PC Card (PCMCIA) utilities in the control panel.

Setup Option Changes

The power management functions in your BIOS contain more options to let you customize your ActionNote. In addition to the options documented in your User's Guide, you can also enable a time out interval for the serial port, the parallel port, and the diskette drive (FDD). Also, the default for the Power Management option is Enabled.

Also, the options on page 3 of your system's Setup program now support your system's capabilities more easily. The following table lists these Setup options:

Setup page 3 options

Setting	Options	Description
Internal Cache	Enabled* Disabled	Controls the processor's Internal cache operation
External Cache	Enabled Disabled*	Controls the processor's external cache operation when external cache is installed
Serial Port	3F8h* 2F8h 3E8h 2E8h Disabled	Assigns the serial port address
Serial Port 2	3F8h 2F8h* 3E8h 2E8h Disabled	Assigns the port address for the fax/modem or IrDA device, when Installed
Parallel Port	278h* 378h 3BCh Disabled	Controls the parallel port operation
Audio I/O	220h* 230h 240h 250h	Identifies the I/O setting the audio card uses
Audio IRQ	5 7 9 10	Identifies the IRQ setting the audio card uses
Pointing Device	Enabled* Disabled	lets you disable the built-in touchpad, In case you connect a serial mouse
Block DE	Enabled Disabled*	Enables support for block mode transfers, if your hard disk drive supports it
Serial 2	Fax/modem IR*	Lets you define serial Port 2 as either the optional Fax/modem or IrDA interface

* Default setting

.. Autodetects ECP or EPP devices when connected and turned on at system start-up

About Your Software

Before you set up and use your EPSON® ActionNote™ computer, be sure to read the information on this card about the software and online manuals installed on your system. This information is also available in the About Your Software online documentation.

You must use a modem with several of the software applications. If your system didn't come with one installed, you can install an optional internal fax/modem, connect an external modem to your serial port, or use a fax/modem PC card. See your User's **Guide** for instructions.

Where to Go for Help

All ActionNote systems come with the software listed below installed on the hard disk drive. If you have trouble using any of these programs, first check to see if the software includes online help or an online user manual. Many programs also provide support through CompuServe® forums; check your software documentation for information.

If these sources do not help you solve the problem, contact the software manufacturer for assistance at any of the numbers given on this card. Some 800 numbers may not be available in Canada.

- I (Windows® 3.1 and MS-DOS⁰ installation only) Microsoft MS-DOS 6.22 operating system software installed on the hard disk drive; for more information, type `HELP` at the DOS prompt.

Technical support: Microsoft FastTips,
a free 24-hour automated service
at (800) 936-4200

or: EPSON Connection
at (800) 922-8911 (U.S. and Canada)
Fax-back (310) 782-4214

- I (Windows 3.1 and DOS installation only) Microsoft Windows 3.11 graphical user interface software installed on the hard disk drive; including a documentation fulfillment card and online help; for more information, press the **F1** key.

Technical support: Microsoft FastTips,
a free 24-hour automated service
at (800) 936-4200

or: EPSON Connection
at (800) 922-8911 (U.S. and Canada)
Fax-back: (310) 782-4214

- I (Windows 95 installation only) Microsoft Windows95 graphical user interface software installed on the hard disk drive; including the **Introducing Windows 95** manual and online help; for more information, press the **F1** key.

Technical support: Microsoft FastTips,
a free 24-hour automated service
at (800) 936-4200

Microsoft and WINNEWS areas
of America Online, Prodigy, and
CompuServe, or Microsoft's Internet
web page

or: EPSON Connection
at (800) 922-8911 (U.S. and Canada)
Fax-back: (310) 782-4214

- SystemSoft® PC card software utilities including CardSoft and CardWizard installed on the hard disk drive; printed and online PCMCIA Card Software Users' Guide.

Technical support EPSON Connection
at (800) 922-8911 (U.S. and Canada)
Fax-back: (310) 782-4214

- Lotus® SmartSuite™ version 3 integrated application package installed on the hard disk drive; for more information, see the online help; brochure and Lotus Technical Support information included.

Technical support EPSON Connection
at (800) 922-8911 (U.S. and Canada)
Fax-back: (310) 782-4214

- OAG® (Official Airline Guide) FlightDisk* Worldwide edition; for DOS/Windows 3.1 software installed on the hard disk drive (send in the coupon for the latest version for Windows 95); brochure and subscription information included.

Technical support: (800) 525-1138

- America Online® news and information service software installed on the hard disk drive; brochure, subscription, and free trial information included.

Technical support: (800) 827-6364
BBS (800) 827-5808

- CompuServe WinCIM® Information Manager for CompuServe news and information service; software installed on the hard disk drive; brochure, subscription, and free trial information included.

Technical support (800) 848-8990

- **PRODIGY®** news and information service; software installed on the hard disk drive; brochure, subscription, and free trial information included.

Technical support (800) 776-3449

- **NetCom™** NetCruiser Internet access service; brochure, subscription, and free trial information included.

Technical support (408) 983-5970

- (ActionNote 895 only) **Delrina WinComm** and **WinFax Lite** modem/fax communications software installed on the hard disk drive; printed manual included.

Technical support EPSON Connection
at (800) 922-8911 (U.S. and Canada)
Fax-back: (310) 782-4214

- **ARK®** **Workspace™** alternative interface for Windows installed on the hard disk drive.

Technical support EPSON Connection
at (800) 922-8911 (U.S. and Canada)
Fax-back: (310) 782-4214

EPSON is a registered trademark of Seiko Epson Corporation. ActionNote is a trademark and EPSON Connection is a service mark of Epson America, Inc. Other trademarks are trademarks of their respective owners.

Copyright © 1995 by Epson America, Inc.
Torrance, California, USA

400526800
9/95

Choosing Your Operating System

Your EPSON® ActionNote™ allows you a one time installation choice of either windows®95 or windows 3.1 (which includes MS-DOS®) as your operating system the first time you start your computer. Regardless of the operating system you choose, you can use the all of the applications that come with your ActionNote.

CAUTION

Be careful as you go through the procedure. If you decide you want the other operating system, you must purchase it.

Before you can make your final operating system selection, you see several screens that refer to Windows 95. Although Windows 95 does some preliminary setup activity, it is not already selected as the operating system.

When you start your ActionNote, Windows Setup checks your system and records information about all the hardware devices it finds. You see its progress on the System Detection screen. Next, you see the Welcome to Windows Setup screen. Follow these steps to select your operating system.

1. From the windows 95 setup screen, choose the Next button.
2. **Select your Regional Setting and choose Next.**
3. Select the keyboard layout and you want and choose Next.
4. **Type your user information and choose Next.**
5. **Read the license agreement and select I accept the agreement, then choose Next. (You must do this even if you plan to choose Windows 3.1/MS-DOS; if you do not accept the agreement, the process ends.)**
6. **Type the registration number from your Windows 95 Certificate of Authenticity located in your accessories box; then choose Next. You must enter the registration number or you cannot proceed.**

7. Select your operating system:

- To select Windows 95, choose Next. The Windows 95 Setup screen appears again. Select Next to complete the Windows 95 operating system setup.
- To select Windows 3.1/MS-DOS, choose Change. You see a screen on which you can select either Windows 3.1/MS-DOS or Windows 95. If you select Windows 3.1/MS-DOS, the system deletes the Windows 95 files and installs Windows 3.1/MS-DOS.

Note that, although the dialog box title is a Windows 95 Setup Wizard, it is deleting the Windows 95 files and installing Windows 3.1/MS-DOS. You can obtain a Windows 3.1/MS-DOS manual by sending in the card attached to this document.

- 8. Choose Finish to complete installation. Be patient. It will take a while to install your operating system.**
- 9. Click OK on the Finishing Setup dialog box to restart the system. When the system restarts, Windows 95 users may need to make additional choices. Windows 3.1/MS-DOS users are ready to go.**

Creating Application Disks

Your ActionNote comes with software installed on your hard disk drive. However, in case you need to reinstall a device driver, you should create system and utility disks with the utilities provided.

Before you start, make sure you have enough blank, pre-formatted disks available. How many you need depends on the size of the application.

NOTE

To find out how many formatted disks you need, follow the instruction below to start the utility. It tells you how many disks you need for the application you have chosen. At that point, you can stop if you need to get the right number of pre-formatted disks.

create Application Disks with windows 3.1/MS-DOS

Follows these steps to create application disks:

1. From the Program manager, open Make Diskettes. You see an icon for each application for which you can create disks.
2. Double click on the application icon you want. For example, if you want to create for the audio application software, double click the Audio Application icon.
3. The process is automated. Follow the instructions on the screen and insert blank, pre-formatted disks when prompted.
4. When disk creation is complete, the utility gives you a summary of its activity.

NOTE

To receive Windows 3.1/MS-DOS disks and documentation, send in your Windows 95 manual with the fulfillment card attached to this document.

Create Application Disks with Windows 95

Follow these steps to create disks:

1. With Windows 95 loaded, open the EPSON software group on the Startup button.
2. Open the Utilities folder within the EPSON software folder. The Make Diskettes folder contains an icon for each application for which you can create disks.

3. Double click on the icon you want. For example, if you want to create disks for the PC card utilities software, double-click the PC Card Drivers icon.
4. The process is automated. Follow the instructions on the screen and insert blank, pre-formatted disks when prompted. You can skip a disk if you want by clicking cancel when you are prompted to insert a blank disk for that program disk.

When the process is complete, the utility gives you a summary of how many disks were created.

NOTE

To create a set of Windows 95 system disks, run create system Disks from the System Tools folder. You need 30 pre-formatted disks to make a complete set.

Maintaining System Backups

As well as creating for your applications, you should maintain up-to-date copies of the other files on your hard hand disk. Your operating system includes a backup utility. Use it to make backup copies of your system and data files. In addition, make backup copies of any software for which you do not have the original program disks.

If you need to reinstall any software and you do not have a backup, you may need to obtain program disks from the manufacturer. Contact them at the number(s) listed in your About Your Software documentation.

EPSON is a registered trademark of Seiko Epson Corporation. **ActionNote** is a trademark and **EPSON Connection** is a service mark of Epson America, Inc. Other trademarks are trademarks of their respective owners.

Copyright ©95 by Epson America, Inc.
Torrance, California, USA

400527000
9/95

Mail order to: **EPSON Windows 3.1 Offer**
P.O. Box 3802
Salinas, CA 93912

Type of kit

Windows 3.1/MS-DOS User Pack (diskettes and User's Guide) \$ FREE*

•Add shipping and handling (check one only)

U.S. \$ 9.95

Canada \$ 15.50

Express U.S. \$ 20.00

Express Canada \$ 30.00

State Sales Tax (Residents of CA, MA, NY, TX must add state sales tax) \$ _____

TOTAL \$ _____

Method of payment (choose one)

I am paying by check (enclosed)

(checks must be drawn in U.S. dollars, U.S. banks)

VISA

MasterCard

American Express

Discover Card

Card No. _____

Exp. Date _____

Signature _____

Date _____

EPSDUAL

Getting WINDOWS 3.1/MS-DOS DISKS AND DOCUMENTATION

EPSON has given you the choice of operating systems: either MS-DOS and Windows 3.1 or Windows 95. If you choose Windows 95, we have included both a printed and an on-line User's Guide for the operating system. If you choose Windows 3.1/MS-DOS as your operating system, you can get a user pack that includes diskettes and a User's Guide FREE* from EPSON. Just complete the order form on the other side and mail it in.

How the Offer Works

1. Purchase a qualifying EPSON computer (see item 2 under Offer Terms below).
2. Fill out the order forms on the other side; remove the UPC code from the EPSON box and attach it to the form; write in the product serial number and computer model.
3. Attach a copy of your sales receipt with store name, purchase date, and price with this order form. Make sure this information is legible.
4. Mail your order to us.

Offer Terms

1. This offer good only in the United States and Canada to purchasers of EPSON computers configured by EPSON with a one-time choice of MS-DOS and Windows 3.1, or Windows 95.
2. This offer is valid only for the following models: EPSON ActionNote 890 Series and EPSON ActionNote 900 Series.
3. You must pay shipping and handling charges as listed on this order form.
4. Incomplete orders and claims that do not comply with the terms of this offer will be rejected and not be processed or acknowledged, and accompanying checks will be destroyed.
5. Do not send original or handwritten invoices or sales receipts. Only one offer per unit purchased, subject to verification by EPSON.
6. This upgrade offer is not valid on products purchased for resale. Void where restricted or prohibited by law.
7. EPSON is not responsible for lost, stolen, or misdirected submissions. Do not send cash.
8. This offer is subject to product availability.

IMPORTANT NOTICE DISCLAIMER OF WARRANTY

Epson America makes no representations **or warranties**, either express or implied by or with respect to anything in this manual, and shall not be liable for any implied warranties of merchantability and fitness for a particular purpose or for any indirect special, or consequential damages. Some states do not allow the exclusion of incidental or consequential damages so this exclusion may not apply to you.

COPYRIGHT NOTICE

All rights reserved. No part of this publication may be reproduced, stored in a retrieval system, or transmitted, in any form or by any means, electronic, mechanical, photocopying, recording, or otherwise, without the prior written permission of Epson America, Inc. No potential liability is assumed with respect to the use of information contained herein. Nor is any liability assumed for damages resulting from the use of the information contained herein. Further, this publication and features described herein are subject to change without notice.

TRADEMARKS

EPSON is a registered trademark of Seiko Epson Corporation.

ActionNote, ActionPoint, and ActionPort are trademarks of Epson America, Inc.

EPSON Connection is a service mark of Epson America, Inc.

General notice: Other product names used herein are for identification purposes only and **may** be trademarks of their respective owners. EPSON disclaims any and all rights in those marks.

The Energy Star emblem does not represent EPA endorsement of any product or service.

Important Safety Instructions

Read all of these instructions and save them for later reference. Follow all warnings and instructions marked on the computer and AC power adapter.

- Turn off the computer before cleaning. Clean with a damp cloth only. Do not spill liquid on the computer.
- Use only **the** type of power source indicated on the computer's label.
- Avoid using outlets on the same circuit as photocopiers or air control systems that regularly switch on and off.
- Do not let the computer's power cord become damaged or frayed
- If you use an extension cord with the computer, make sure the total Amp rating of the devices plugged into the extension cord does not exceed the cord's Amp rating. Make sure the total of all devices plugged into the wall outlet does not exceed 15 Amps
- Except as specifically explained in this Users **Guide**, **do** not attempt to service the computer yourself.
- Unplug the computer and refer servicing to qualified service personnel if the power cord or plug is damaged; if liquid has entered the computer; if the computer has been dropped or the cabinet damaged; or if the computer does not operate normally or exhibits a distinct change in performance. Adjust only those controls that are covered by the operating instructions
- When travelling by airplane, be sure to take your computer into the passenger compartment as carry-on luggage to prevent it from being stored in an unpressurized storage area.
- If you plan to use the computer in Germany, observe the following:

To provide adequate short-circuit protection and over-current protection for this computer, the building installation must be protected by a 16 Amp circuit breaker.

Sécurité

Lire attentivement les instructions suivantes et les conserver pour les consulter en cas de besoin. Observer soigneusement tous les overtissements et directives marqués sur l'ordinateur et l'adaptateur secteur.

- Débrancher l'ordinateur avant de le nettoyer. N'utiliser qu'un chiffon humide. Veiller à ne pas renverser de liquides sur l'appareil.
- Utiliser seulement le type de source d'alimentation électrique indiqué sur l'étiquette.
- Ne jamais utiliser une prise sur le même circuit qu'un appareil à photocopies ou un système de contrôle de ventilation avec commutation marche-arrêt automatique.
- S'assurer que le cordon d'alimentation de l'ordinateur n'est pas a bimé ni effiloché.
- Dans le cas où on utilise un cordon de rallonge avec l'ordinateur, s'assurer que l'intensité en ampères requise pour tous les appareils branchés sur ce cordon n'est pas supérieure à la capacité du cordon. S'assurer aussi que cette intensité ne dépasse jamais la somme de 15 ampères pour l'ensemble des appareils branchés sur la prise secteur.
- Sauf dans les cas spécifiques expliqués dans ce manuel de l'utilisateur, ne pas essayer d'entretenir ou de réparer l'ordinateur soi-même.
- **Débrancher l'ordinateur et contacter un technicien** qualifié dans les circonstances suivantes:
 - Si le cordon ou la prise sent abimés; si un liquide a pénétré à l'intérieur de l'appareil; si on a laissé tomber l'appareil ou si le boîtier est endommagé; si l'ordinateur ne fonctionne pas normalement ou fonctionne d'une manière très différente de l'ordinaire. N'ajuster que les commandes décrites dans les directives
 - Pour les voyages par avion, prendre l'ordinateur avec soi dans la cabine comme bagage à main, pour éviter qu'il soit transporté dans une soute non pressurisée.
 - Pour utiliser l'ordinateur en Allemagne, il est nécessaire que le boîtier soit muni d'un disjoncteur de 16 ampères pour protéger l'ordinateur contre les courts-circuits et le survoltage.

Wichtige Sicherheitshinweise

Bitte lesen Sie diese Sicherheitshinweise, und he ben Sie sich zur späteren Verwendung auf. Beachten Sie alle Wamungen und Anweisungen, die auf dem Computer und dem Wechselstromadapter angebracht sind

- Schalten Sie den Computer vor der Reinigung aus. Verwenden Sie zur Reinigung nur ein souberes Tuch. Achten Sie darauf, daß keine Flüssigkeiten auf dem Computer verschüttet werden
- Verwenden Sie nur die auf dem Typenschild des Computers angegebene Stromversorgung.
- Schließen Sie den Computer nicht an denselben Stromkreis an wie Fotokopiergeräte oder Klimaanlage, die sich regelmäßig ein- und ausschalten
- Achten Sie darauf, daß das Netzkabel des Computers stets in einwandfreiem Zustand ist.
- Stellen Sie bei Verwendung eines Verlängerungskabels sicher, daß der gesamte Amperewert aller an das Verlängerungskabel angeschlossenen Geräte den zulässigen Höchstwert des Kabels nicht überschreitet. Stellen Sie ferner sicher, daß der Gesamtwert aller an die Wandsteckdose angeschlossenen Geräte 15 Ampere nicht überschreitet.
- Führen Sie keine Wartungsarbeiten am Computer durch, die **über** das **im Benutzerhandbuch** beschriebene Ausmaß hinausgehen.
- Ziehen Sie den Computer heraus und rufen Sie qualifiziertes Wartungspersonal wenn eine der folgenden Bedingungen auftritt:
 - Das Netzkabel oder der Netzstecker ist beschädigt; Flüssigkeit ist in den Computer eingetreten; der Computer wurde fallengelassen oder das Gehäuse ist beschädigt; der Computer funktioniert nicht ordnungsgemäß oder die Leistung hat sich merklich geändert. Stellen Sie nur die Bedienelemente ein, die in der Gebrauchsanweisung beschrieben sind
 - Nehmen Sie den Computer bei Flugreisen als Handgepäck mit in **den** Fluggastraum damit er nicht in einem drucklosen Frachtraum verstaut wird
 - Beachten Sie den folgenden Hinweis wenn Sie den Computer in Deutschland in Betrieb **nehmen**:
Beim Anschluß des Computers an die Netzversorgung muß sichergestellt werden, daß die Gebäudeinstallation mit einem 16 Ampere Überstromschutzschalter abgesichert ist

FCC COMPLIANCE STATEMENT FOR AMERICAN USERS

This equipment has **been** tested and found to comply with the limits for a class B digital device, pursuant to Part 15 of the FCC Rules. These limits are designed to provide reasonable protection against harmful interference in a residential installation. This equipment generates, uses, and can radiate radio frequency energy **and if not** installed and used in accordance with the instructions may cause harmful interference to radio and television reception. However, there is no guarantee that interference will not occur in a particular installation. If this equipment does cause interference to radio and television reception which can be determined by turning the equipment off and on, the user is encouraged to try to correct the interference by one or more of the following measures:

- 1 Reorient or relocate the receiving antenna
- 1 Increase the separation between the equipment and receiver
- 1 Connect the equipment into an outlet on a circuit different from that to which the receiver is connected
- 1 Consult an experienced radio/TV technician for help.

WARNING

The connection of a non-shielded equipment interface cable to this equipment will invalidate the FCC Certification of this device and may cause interference levels that exceed the limits established by the FCC for this equipment. It is the responsibility of the user to obtain and use a shielded equipment interface cable with this device. If this equipment has more than one interface connector, do not leave cables **connected** to unused interfaces.

Changes or modifications not expressly approved by the manufacturer could void the user's authority to operate the equipment.

FOR CANADIAN USERS

This digital apparatus does not exceed the Class B limits for radio noise emissions from digital apparatus as set out in the radio interference regulations of the Canadian Department of Communications.

Le présent appareil numérique n'émet pas de bruits radioélectriques dépassant les limites applicables aux appareils numériques de Classe B prescrites dans le règlement sur le brouillage radioélectrique édicté par le Ministère des Communications du Canada.

Contents

1 Getting Started

Opening Your Computer	1-2
Powering Your Computer	1-2
Connecting the AC Power Adapter	1-3
Turning the Computer On and Off	1-4
Checking the Indicator Lights..	1-4
Adjusting the Screen Controls	1-6
Using the ActionPoint Touchpad	1-6
Learning More About ActionPoint	1-8
Using the Keyboard	1-8
Using the Fn Key	1-9
Using the Embedded Numeric Keypad	1-9
Creating Software Diskettes	1-10

2 Powering the Computer

Using the AC Power Adapter.	2-1
Using the Battery	2-2
Recharging the Battery.	2-3
Replacing the Battery	2-3
Using Power Management	2-5
Low Battery Protection	2-6
Using Energy Wisely	2-8

3 Getting to Work

Using Passwords	3-1
Entering a Password.	3-1
Using Diskettes	3-2
Resetting the Computer	3-3
Working Comfortably	3-4

4 Caring for Your Computer

Protecting the Hard Disk Drive	4-2
Moving and Storing the Computer	4-3
Cleaning Your ActionNote	4-4
Cleaning the ActionPoint Touchpad	4-4
Cleaning the Diskette Drive	4-4

5 Upgrading Internal Components

Upgrading the Hard Disk Drive	5-1
Removing the Hard Disk Drive	5-2
Replacing a Hard Disk Drive	5-4
Removing and Replacing the Keyboard	5-7
Removing the Keyboard	5-7
Replacing the Keyboard	5-10
Upgrading Your Memory	5-11
Removing a Memory Module	5-12
Installing a Memory Module	5-13
Installing a Fax/Modem or Infrared Device	5-14
Connecting a Phone Line	5-17

6 Customizing Your Computer

Customizing Your ActionPoint	6-1
Customizing Computer Settings	6-3
Starting Setup.	6-4
Changing the Settings	6-4
Customizing Power Management	6-8
Using Instant On and Saving to Disk	6-9
Using Password Security	6-11
Setting or Changing a Password	6-11
Setting a Password	6-12
Deleting or Changing a Password	6-13
Using Video Drivers and Utilities	6-13

7 Troubleshooting

Where to Get Help.	7-1
Electronic Support Services	7-2
Identifying Your System	7-4
Error Messages	7-5

Troubleshooting Your ActionNote	7-5
The Computer Won't Start	7-6
The LCD Screen Is Blank	7-8
The Computer Locks Up	7-9
Your Password Isn't Working	7-9
You Can't Access Data on a Diskette	7-10
The Diskette Drive Isn't Working.	7-10
You Can't Access Files on the Hard Disk Drive	7-11
A PC Card Isn't Working	7-11
The ActionPoint Isn't Working Correctly	7-13
An External Monitor Is Blank	7-14
An External Pointing Device Doesn't Work	7-14
Your Printer Isn't Working	7-16
The Memory Count Is Incorrect	7-16
Your Software Isn't Working Correctly ...	7-16

A Specifications

CPU and Memory	A-1
Controllers	A-2
Interfaces	A-3
Keyboard	A-4
ActionPoint Touchpad	A-4
Volume Control	A-4
Mass Storage	A-5
LCD Screen	A-5
Setup Program	A-5
Software	A-6
Power Sources	A-6
AC Power Adapter	A-6
AC Power Adapter Dimensions.....	A-7
Fax/Modem Specifications	A-7
Environmental Requirements	A-8
Physical Dimensions	A-8

Index

1 Getting Started



Your EPSON® ActionNote™ computer is all set up and ready to use. This chapter gives you the information you need to get started. You'll find a list of the computer's features on the back cover of this manual, illustrations of your system on the inside front cover, and a place to write important information about your ActionNote on the inside back cover.

If you have questions, this manual or the online version should provide you with answers. Read the troubleshooting information in Chapter 7 or call the EPSON ConnectionalSM at (800) 922-8911 for help.

Opening Your Computer

To open your ActionNote, slide the latches on each side of the computer's lid forward and lift up the screen.

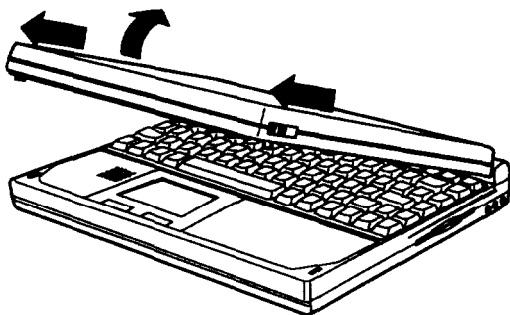

Powering Your Computer

Your computer is shipped with a charged battery and is ready to use when you take it out of the box. You don't need to plug it in. To conserve battery power, however, (or if your battery has lost its charge while in storage,) you should use the AC power adapter to connect your computer to an electrical outlet whenever possible. The adapter also recharges your battery.

Connecting the AC Power Adapter

The lightweight AC power adapter included with your ActionNote operates in the input ranges 100 to 250 VAC and 40/63 Hz.

NOTE

*If you purchased your computer out side the **United States**, you have the international AC power adapter. See “Using the international AC Power Adapter” in Appendix B for more information.*

Follow these steps to connect the AC power adapter:

1. Plug the connector into the **DC-in** port on the back of the computer.

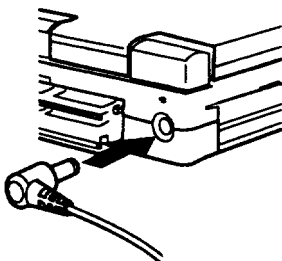

2. Flip the adapter's two prongs out of their compartment, then plug the adapter into an electrical outlet.

Recharging the battery takes about 3 hours with the computer turned on, and about 1.5 hours when it is turned off. While it recharges, the charge indicator light is orange. When the battery is fully charged, it is green.

Turning the Computer On and Off

The on/off button is beneath the screen on your right

Press the button and hold it briefly to turn on the computer. As the computer starts, it does a complete self test of its circuits and drives.

To turn the computer off, press and hold the button for two seconds. Be sure to save your work before you turn off the computer.





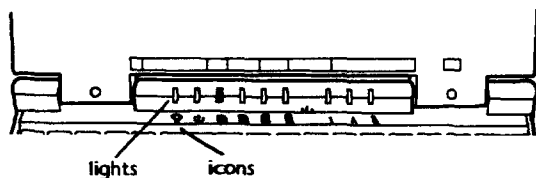

Checking the Indicator Lights

The indicator lights above the keyboard give you information about your computer.



The following table identifies the indicator lights for your ActionNote.

Indicator lights

con	Name	Description
	Power mode Green Flashing green	Computer is on Very low battery; system is about to power down
	Suspend mode: Green Flashing green	Standby mode: press any key to return to full power Suspend mode: press Suspend/Resume to return to full power
	Charge mode: Orange Flashing orange Green	Battery is charging normally Battery is not installed correctly or is damaged Battery is fully charged
	Diskette drive	Computer is accessing diskette drive
	Hard disk drive	Computer is accessing hard disk drive
	PC card	PC card is inserted
1	Num Lock	Num Lock is on, which activates the embedded numeric keypad
A	Caps Lock	Caps Lock is on
	scroll Lock	Scroll Lock is on

Adjusting the Screen Controls

The screen contrast and brightness controls are located at the bottom of the screen.

Slide the contrast control to the right to increase the contrast, or to the left to decrease it. On dual scan screens, slide the brightness control to the right to lighten the screen, or to the left to darken it

Unless you need a bright screen, you can extend battery life and save energy by making it dimmer.

Using the ActionPoint Touchpad

You can move your cursor on the screen by sliding your finger along the built-in ActionPoint™ touchpad. It works with any software application that uses PS/2® compatible mouse drivers, and has a utility that lets you adjust its response.

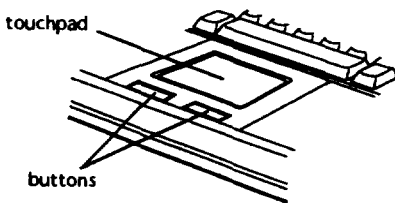

To **move the** cursor, slide your finger along the ActionPoint touchpad. If your finger is too close to the edge, lift it and put it down on the opposite edge. The cursor moves only when your finger touches the pad. See “Customizing Your ActionPoint” in Chapter 6 or the utility’s online help for more about cursor settings.

To **click**, quickly press and release the left touchpad button **or** gently tap the touchpad once.

To **select and move an item** (click and drag), doubletap on the touchpad and then slide your finger across it. You can also hold down the left touchpad button while sliding your finger along the touchpad.

When you reach the edge of the touchpad surface, the pointer continues to move in the same direction until you lift or move your finger. This feature is called “Edge Motion.”

When software manuals tell you to use your mouse, use these ActionPoint equivalents:

Touchpad movements

Mouse	ActionPoint
Click	Tap
Double-click	Double-tap
Drag	Slide
Click and drag select	Double-tap, slide
Right mouse button	Tap Right touchpad button

Learning More About ActionPoint

For information about changing the speed and sensitivity of your touchpad, see “Customizing Your ActionPoint” in Chapter 6. You can also access the online help in the touchpad’s control panel

Using the Keyboard

Your computer’s keyboard has 85 keys that provide the same functions as a full-sized keyboard, thanks to function keys and an embedded numeric keypad. The Fn key provides a second function for other keys.

The keyboard on the ActionNote is available with different layouts for different languages. You can also use the operating system to reassign the layout of your keyboard. See your operating system documentation.

Using the Fn Key

To use special functions, hold down the **Fn** key and then press the second key. A key's special function is labeled in blue.

Fn key functions

Key	Label	Function
Fn F8	Set Up	Displays Power Management screen
Fn F9	Invert	Toggles between normal and reverse video (passive matrix only)
Fn F10	Display	Toggles between displaying the image on the LCD, external monitor, or both

Using the Embedded Numeric Keypad

In Num Lock mode, the keys in the embedded numeric keypad give you the number or symbol for that key instead of the letter.

Press **Num Lock** to turn Num Lock mode on and off. To enter the letter while in Num Lock press **Fn** plus the key. With Num Lock off, you can enter a number or symbol on the numeric keypad by pressing **Fn** plus the key.

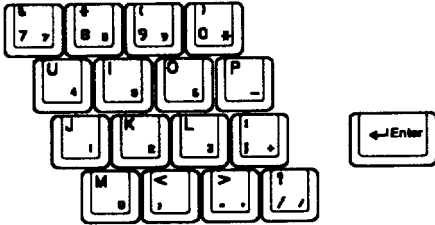

Creating Software Diskettes

Your computer came with software installed; the program diskettes are not included. However, you may need the diskettes to set up a new printer or re-install a program. You have utilities that let you create these diskettes See your “Choosing Your Operating System” documentation for information

2 *Powering the Computer*

This chapter describes how to conserve your computer's battery and save energy using the power management tools supplied.

Using the AC Power Adapter

The AC power adapter charges the battery and runs the computer off power from an electrical outlet. Use the adapter whenever you have access to an outlet, especially when you are using a PC card

Check the charge indicator light to monitor charging status when you use the adapter.

Battery charging status

Light	Status
Orange	Battery is charging normally
Green	Battery is fully charged
Flashing orange	Battery is not installed properly or is damaged

If you plan to use the computer in countries other than the U.S. or Canada, you'll need to purchase the international AC power adapter. EPSON also offers an automobile adapter. See "Using the International AC Power Adapter"

and “Using the Automobile Adapter” in Appendix B of the online manual for more information.

CAUTION

To avoid damaging the computer, use on/y adapters designed for the Action/Vote 890 series computers.

Using the Battery

The removable NiMH battery can provide between 4 and 6 hours of power when you use your computer’s power management features.

How long the battery lasts depends on how you use the computer. It consumes more power when you do the following:

- Use a bright screen display
- Access the drives often
- Use a PC card

Your operating system may provide ways to view your battery’s status and additional power management features. Check your operating system documentation.

Recharging the Battery

The battery that comes with your system is rechargeable. It takes approximately 1.5 hours to charge a completely discharged battery when the computer is off or when it is in Suspend mode. If you use the system while the battery is recharging it can take up to 3 hours.

If you find that over time the battery is losing its charge faster, the battery life may be reaching its end. Try letting it discharge completely; then recharge it. You can also use the optional external battery charger to recondition the battery.

Replacing the Battery

If you have additional batteries, keep them fully charged so you can replace your battery when it runs low. This is especially useful when you're traveling.

CAUTION

Use only the NiMH battery pack designed for the ActionNote 890 series computers.

You can use the optional external battery charger to charge an extra battery while using another one in your computer. See

“Using the Battery HyperCharger/Conditioner” in Appendix B of the online manual for more information.

NOTE

Contact your local **government agency for recycling information on NiMH batteries.**

Follow these steps to replace the battery:

1. Save the files you're revising.
2. Press the on/off button
3. Close the screen and turn the computer over.

CAUTION

To avoid a short, do not touch the battery contacts with metal objects.

4. Press the battery release lever, then lift the battery up and out of the case.

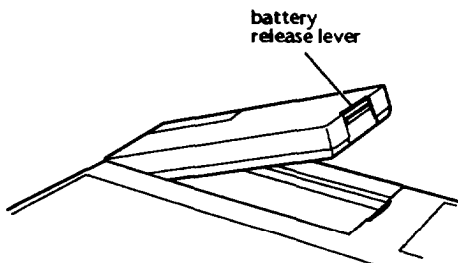

5. Insert the new battery at an angle and then lower it into place.

Using Power Management

Your ActionNote offers a variety of power management features to help you conserve battery power. Your computer has three power-saving modes Idle, Standby, and Suspend. These modes progressively reduce computer functions and save battery life by turning off various system components when they are not in use, as described in the following table:

Power saving modes

<i>Mode</i>	<i>Description</i>
System idle	CPU clock speed reduced
System standby	CPU clock speed further reduced, screen backlight turned off, hard disk drive and other components in low power state
Suspend mode	CPU clock stopped, screen and hard disk drive turned off, and other components

The screen and hard disk drive also have their own independent timeout periods and the screen backlight turns off whenever you close the cover.

You can press the **Suspend/Resume** button (located between the brightness and contrast controls) at any time to enter Suspend mode

and temporarily stop system activity. After **you** press **Suspend/Resume**, it takes a moment for the computer to enter Suspend mode. Then the Suspend indicator light comes on and the screen becomes dark.

NOTE

*In environments where you can perform background tasks, the system may appear to be inactive when it is performing one of these tasks. Check this possibility before pressing **Suspend/Resume**.*

With a fully charged battery, the computer can remain in Suspend mode for several hours without losing data. To resume activity, press the **Suspend/Resume** button again.

Low Battery Protection

The ActionNote's power management features protect your data when the battery runs low. When you have only a few minutes of power left, the power indicator light flashes and the computer beeps. At this point, you should immediately save your data and either connect the AC power adapter or turn off the computer and replace the battery (as described earlier in this chapter).

In addition, the computer can be set up to enter Suspend mode when the battery power reaches a minimum level. This protects the contents of your computer's memory for several hours.

You can also configure your ActionNote to save your data to the hard disk drive whenever your battery can no longer provide enough power. With this configuration, the memory contents are saved on the hard disk drive and protected indefinitely.

To resume activity where you left off after saving to disk, replace your battery and press the on/off button.

Your ActionNote also provides a similar Instant On feature. When you set up your computer to use Instant On, you can press the **Suspend/Resume** button to save your data and turn off the power at the same time. To start up again “instantly” (without reloading your operating system or software applications), simply press the on/off button.

For instructions on setting up your ActionNote to use the Save to Disk and Instant On features, see “Using Instant On and Saving to Disk” in Chapter 6.

Using Energy Wisely

By purchasing this Energy Star compliant computer, you join a growing number of users concerned about conserving energy. Here are a few energy-saving tips:

- When using a printer and external monitor, check to see if they are Energy Star compliant. If not, turn them off when you're not using them.
- Use the print preview option in your software before you print something. You'll be able to catch formatting errors before you commit them to paper.
- If you have an electronic mail system available to you, send E-mail rather than memos. Not only is this faster, but you'll save paper and storage space too.
- Use recycled paper and recycle your used paper whenever you can.

3 *Getting to Work*

This chapter contains practical information about using your ActionNote. Reading it now can save you time later.

.....

Using Passwords

Passwords help protect data from theft. Your ActionNote offers two types of passwords a Setup password that controls access to the Setup utility, and a System password that controls access to your computer.

For details on setting both types of passwords, see “Setting a Password” in Chapter 6.

NOTE

The passwords described here are not related to the password you may set through you operating system.

Entering a Password

Whether the computer is configured with a System or Setup password, you enter the password in the same way. When you turn on

your system (for the System password) or access Setup (for the Setup password), you see this prompt:

Enter password:

Type the correct password and press Enter. To protect your password, the screen does not display the characters you type.

If you type the password incorrectly, the computer displays this message and repeats the password prompt:

Password is incorrect

Enter password:

Try typing the password again. The computer allows you three tries to enter it correctly. If you don't enter a System password correctly, the system locks up. Turn off the computer, wait 30 seconds, and try again. If you don't enter a Setup password correctly, the computer loads the operating system without letting you access Setup. See "Using Password Security" in Chapter 6 for more information

.....

Using Diskettes

You can use either 720KB double-density or 1.44MB high-density, double-sided diskettes in your 3.5-inch, 1.44MB diskette drive.

To insert a diskette, hold it with the label facing up and the shutter leading into the drive. Slide it all the way into the drive.

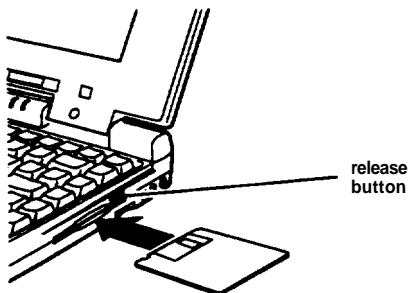

To remove the diskette, make sure the diskette drive light is off. Then press the release button and pull out the diskette.

CAUTION

Never remove a diskette or reset or turn off the computer while the diskette drive is being accessed; you could lose data. Also, be sure to remove the diskette before you turn off the computer.

.....

Resetting the Computer

Occasionally, when the computer doesn't respond, you may need to reset it. Resetting clears the memory and is easier on the hardware than turning the computer off.

To reset the computer, hold down the Ctrl key and press the Alt and Del keys simultaneously. Then follow any instructions you see-.

Working Comfortably

It's easy to spend a lot of time working on the computer. But too much work time without a break can cause repetitive motion strain on your hands and arms. Follow these suggestions to relieve strain:

- Your ActionNote is ergonomically designed with a palm rest and embedded ActionPoint touchpad. Try to take advantage of these while you're working.
- If you do a lot of typing avoid wrist strain by resting your forearms on an arm rest or other surface while you type.
- Keep your fingers relaxed, and don't press too hard on the keys.
- Remove your hands from the keyboard when you are not typing take frequent breaks, and stretch **your** fingers.

4 *Caring for Your Computer*

Although it has been built for years of use, your ActionNote contains fragile circuits and needs to be handled with care to keep it in good working order:

- Keep the computer and AC power adapter dry, and do not subject them to extreme heat or cold.
- To prevent damage to the LCD, do not place external devices on top of the computer, even when it is closed.
- When you are not using the serial, parallel, video ports, or the PC card slots, keep their covers closed to prevent damage to the pins in the ports.
- Be sure you turn off the computer before you connect devices other than PC cards that support hot swapping.

Protecting the Hard Disk Drive

Your hard disk drive is designed for travel and lots of use. Follow these precautions, however, to protect your data and prolong hard disk life.

- Never turn off or reset the computer when it is copying data to or from the hard disk drive (the indicator light is on).
- Never remove the hard disk drive when the computer is on.
- After turning the power off, wait 20 seconds before moving the computer. This allows the disks in the drive to stop spinning and the read/write heads to lock in place.
- Although the hard disk drive is very reliable, be sure to back up your files regularly.

Moving and Storing the Computer

Before you move your ActionNote, make sure the power is off and the screen is closed.

Remove any diskettes. Use a carrying case or equivalent. If you have any devices attached, make sure they are turned off and unplugged.

The ActionNote has an operating temperature range of 42 to 95° Fahrenheit, or 5 to 35° Centigrade. You should keep your computer well within that range to prevent damage.

If you will not be using your ActionNote for a while, store it in a dry place, protected from dust and moisture.

The ActionNote can tolerate storage temperatures from -4 to 140° Fahrenheit, or -20 to 60° Centigrade. Also, if temperatures change more quickly than 5° Centigrade per hour, it may damage your hard disk drive or screen.

CAUTION

When traveling by air, be sure to take your computer as carry-on luggage to prevent it from being stored in an unpressurized storage area.

..... Cleaning Your ActionNote

You may need to clean your ActionNote occasionally. Clean the exterior with a soft, damp cloth. Spray glass cleaner on a lint-free, soft cloth to clean the LCD screen; do not spray the cleaner directly onto the screen.

Cleaning the ActionPoint Touchpad

The ActionPoint is sensitive to moisture which may affect your cursor movement. Use a soft, lint-free cloth to clean the ActionPoint. If you need something stronger, lightly moisten the cloth with glass cleaner. Do not spray the cleaner directly onto the ActionPoint, and make sure its surface is completely dry before you use it.

Cleaning the Diskette Drive

It's a good idea to clean the diskette drive occasionally. The drive heads are exposed to magnetic contaminants in the air and on diskettes. Many diskette manufacturers offer diskette drive cleaning kits. Just follow the instructions in the kit.

5 *Upgrading Internal Components*

Several internal components in your ActionNote can be upgraded including the hard disk drive and system memory.

In addition, if your computer did not come with the internal audio card, you can have your Authorized EPSON Servicer install one.

Upgrading the Hard Disk Drive

If you need to remove the existing drive, just follow the instructions below. You won't need any tools.

Your ActionNote supports EPSON-qualified, IDE hard disk drives with a 2.5-inch form factor and a maximum height of 19 mm. Contact the EPSON Connection or your dealer to find out about the latest upgrade options

CAUTION

Before you replace your hard disk drive, be sure to make backup copies of all your files and programs.

Removing the Hard Disk Drive

Follow these steps to remove the drive:

1. Turn off the computer and disconnect any external devices or cables.
2. Close the LCD screen and turn the computer over.
3. Press the latch away from the hard disk drive cover and slide the cover back slightly. Then lift the cover off, as shown.

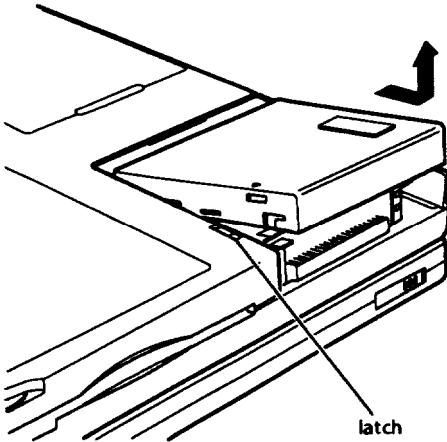

4. Pull up on the two metal tabs to disconnect the drive, and remove it from the case.

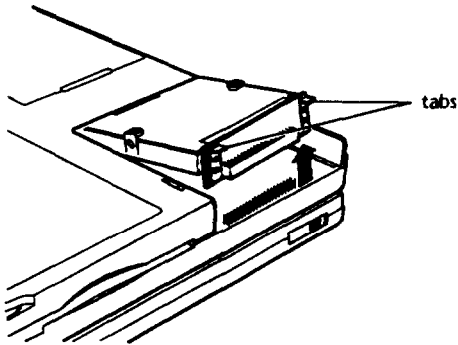

5. If you need to disconnect the connector card, hold it by the edges and pull it away from the drive, as shown below.

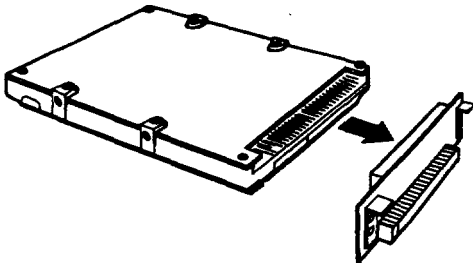

Replacing a Hard Disk Drive

Follow these steps to replace a hard disk drive. If your new drive already has the connector card attached, start with step 3.

1. If necessary, attach the connector card. Align the holes in the card with the group of 44 pins on the right side of the drive connector.

Make sure the connector does not cover the group of four pins on the left side of the drive connector.

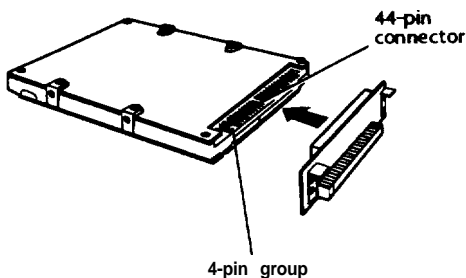

2. When the holes and pins are properly aligned, carefully push the card straight onto the pins, pressing firmly on the card until it is in place.

The hard disk drive compartment on your ActionNote can accommodate IDE standard drives up to 19 mm high. If the drive that comes with your computer is less than 19 mm high, it is installed above a black foam spacer. If you are going to install a 19 mm drive, remove the spacer from the compartment before you perform step 3.

- 3 Insert the drive and card into the drive compartment, aligning the connector on the card with the pins in the compartment. Press down on the metal tabs until the drive is fully seated.

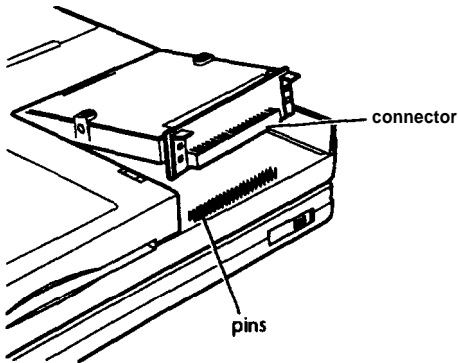

4. Position the drive cover over the compartment so that the small arrow on the cover aligns with the first notch in the latch. Lower the cover and then slide it until it snaps shut.

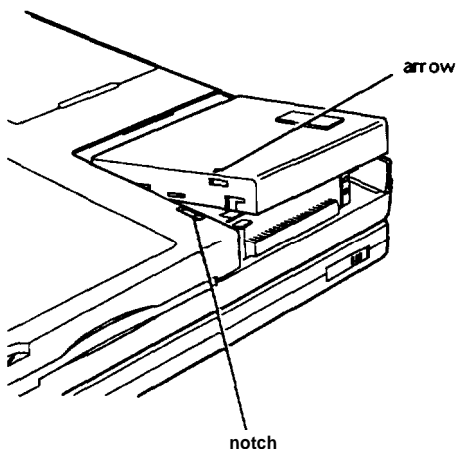

5. Run Setup as described under “Customizing Computer Settings” in Chapter 6 to make sure the computer recognizes your new drive.
6. After installing the operating system, run the PHDISK utility to create a 25MB partition on the drive. See “Using Instant On and Saving to Disk” in Chapter 6 for more information.

.....

Removing and Replacing the Keyboard

You need to remove the keyboard to install memory. However, you don't need to disconnect the keyboard cables.

Removing the Keyboard

Follow these steps to remove the keyboard:

1. Turn off the computer and disconnect the AC power adapter.
2. Disconnect any attached external devices and cables.
3. Open the screen to 180°, or as wide as you can.



4. Remove the plastic caps on both sides of the case below the screen. Use a small screwdriver to pry each cap loose and then slide it off, as shown.

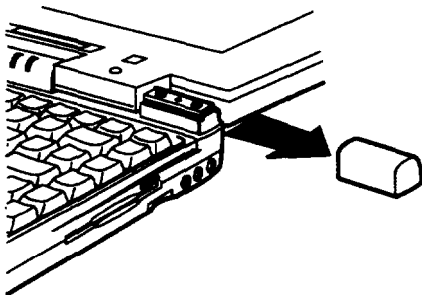

5. Use a small screwdriver to gently pry up the plastic strip above the keyboard. You can pry in the center as shown here, or in front of the left and right hinges.

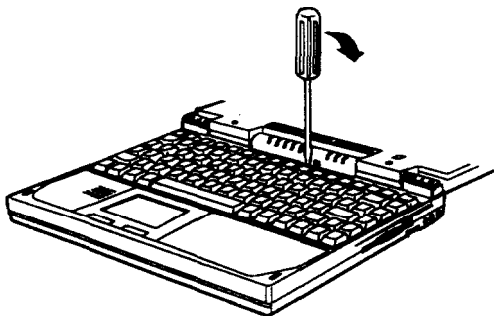

6. Lift up the strip and remove it from the case.

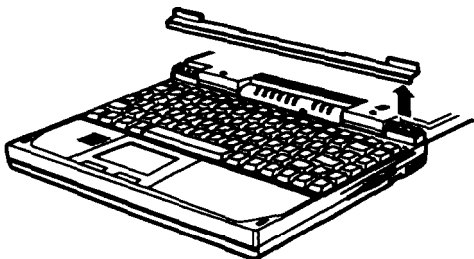

7. Being careful not to pull on the keyboard cables, gently lift the keyboard, holding it by the top edge. Remove it from the case and place it on a flat surface in front of the computer.

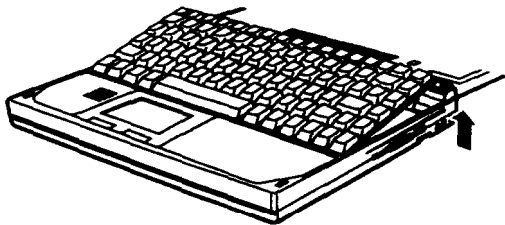

Replacing the Keyboard

When you are ready to replace the keyboard, refer to the illustrations in the previous section as you follow these steps:

1. Carefully lift up the keyboard and position it over the case.
2. Hold the keyboard at a 45° angle and align it so that the clips on the bottom edge fit into the case.
3. Gently lower the top of the keyboard until it is securely in place. You should not have to force it. Make **sure** the flat cables are not caught under the edge of the keyboard.

The top edge of the keyboard should not overlap the bronze-colored ledge of the case. If you have difficulty aligning the keyboard try the following approach hold the top of the keyboard in the center with the keyboard at a 45° angle and line up the clips on the bottom of the keyboard with the case. Gently lift up the keyboard until the clips are aligned.

4. Position the plastic strip above the keyboard and push it back until it snaps into place. The strip fits tightly but should not obstruct the function keys

5. Slide the plastic caps over the screws on each side of the case and snap them into position. Make sure you use the correct cap for the left or right side; they do not slide into place on the wrong side.

After you have replaced the keyboard, check that the keys operate smoothly. If any of the keys stick, press back again on the plastic strip under each hinge cover and in the center of the plastic strip. If the keys still stick, repeat the keyboard replacement procedure.

Upgrading Your Memory

Your ActionNote comes with 8MB of memory. You can increase your computer's memory to up to 24MB by installing a 4, 8, or 16MB snap-in memory module.

If you are using Instant On or Save to Disk, you need to rerun the PHDISK utility after you have changed the amount of memory. See Chapter 6 for more information.

CAUTION

A memory module is delicate and needs careful handling. If you don't feel confident installing it yourself, ask your Authorized EPSON Servicer for assistance.

Removing a Memory Module

Your computer may have a memory module installed. If you want to replace it with a higher-capacity module, follow the steps below to remove the original memory module. If it doesn't have a module installed, see the next section, "Installing a Memory Module," to Install one.

1. Remove the keyboard as described In the previous section.
2. Press each of the retaining clips toward the side of the memory module socket and lift the module until it is released.

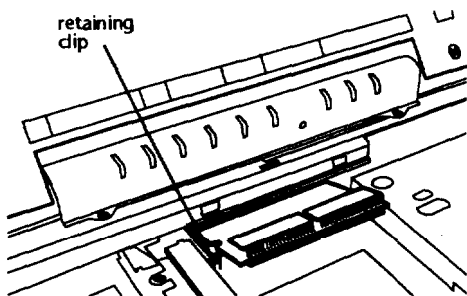

3. Pull the module out of the socket You are now ready to install the new memory module.

Installing a Memory Module

Follow these steps to install the new memory module:

CAUTION

Computer memory modules are sensitive to static electricity. Ground yourself by touching a metal surface before you touch the memory module. Keep it safe inside its anti-static packaging until you are ready to install it. Remain as stationary as possible while you install it.

1. Holding the memory module with the notch on the upper right corner, align it with the connector at the edge of the socket.
2. Insert the memory module into the socket at an angle, pressing along the edge until it clicks into place.

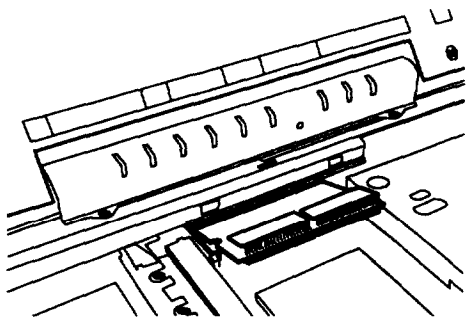

3. Press down on the module until it snaps into the retaining clips on the sides
4. Replace the keyboard as described in the previous section.
5. Run Setup, as described under “Customizing Computer Settings” in Chapter 6, to make sure your computer recognizes the new memory. (When you turn on the computer, it might warn you of a memory size mismatch.)

.....

Installing a Fax/Modem or Infrared Device

If your computer did not come with the internal fax/modem, you can install either a fax/modem or an infrared device yourself. If you have a fax/modem already installed, you can replace it with an infrared device. Follow these steps to install the device:

1. Remove the keyboard as described under “Removing the Keyboard.”

2. Refer to the illustration below to locate the connector on the system board.

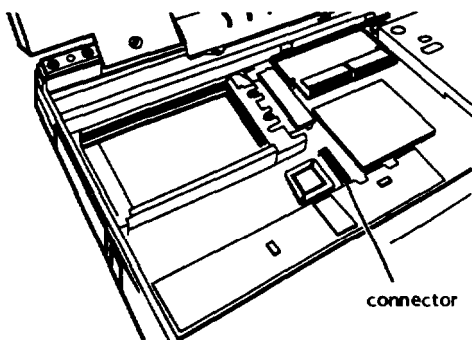

3. Remove the plastic insert covering the port opening on the left side of the computer, next to the PC card slots. Insert the tip of a screwdriver through the slot in the plastic cover and carefully pry the cover off. You may need to use gently increasing pressure to pull the cover away from the case and push it out.

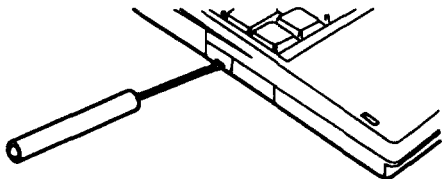

4. Insert the phone jack end of the fax/modem card or the LED window of the infrared card into the port opening and align the connector on the card with the connector on the system board as shown below.

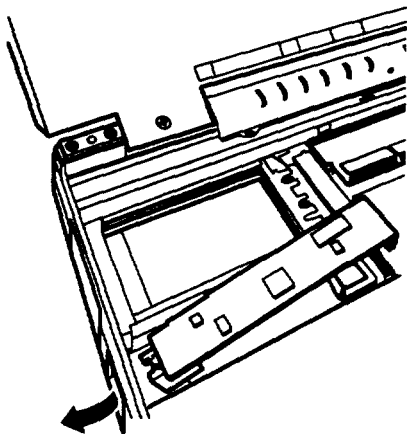

5. Make sure the pins in the connector are directly over the holes in the connector on the system board. Then gently push the card straight into the connector.
6. If you are installing an infrared device, you must cover the port opening with the clear plastic cover provided with the device.

7. If you are finished installing internal components, replace the keyboard as described under “Replacing the Keyboard.”
8. Run Setup, as described under “Customizing Computer Settings” in Chapter 6, to make sure the port address is set correctly for the fax/modem or the Infrared device. The default setting is COM2.

For information about using your fax/modem, see the following section. For more information on using an infrared device, see Appendix B in the online manual.

Connecting a Phone Line

You can connect your telephone line directly to the fax/modem in your ActionNote with a standard RJ-11 telephone cable.

Before you connect the phone line, you need to install the software that came with your *fax/modem*. See your software manuals for Instructions on installing these programs and using them with your system.

Position the phone line connector so the tab faces down and aligns with the notch in the phone jack on the left side of your computer.

CAUTION

Some commercial telephones have high-voltage digital telephone lines that can damage the fax/modem. If in doubt, check before connecting.

Insert the cable into the phone jack. (Connect the other end of the cable to the modular jack outlet for your phone line.)

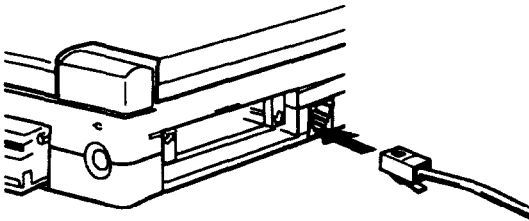

NOTE

You fax/modem also has an internal modem command set that you may need in certain situations to control data transmission. See the manual that came with you modem for more information.

6 Customizing Your Computer

You can customize your ActionNote in a variety of ways covered in this chapter.

..... Customizing Your ActionPoint

You can adjust the amount of pressure you need to apply to your touchpad as well as the speed and precision of the cursor movement.

Select the ActionPoint Configuration control panel utility. Then use the table below to change your settings

ActionPoint configuration panels

Panel	Features	Description
Pointer settings	Color ad size	Lets you choose from nine pointers in three color schemes and three sizes
	Pointer growth	When enabled, medium or large pointers grow to the selected size while moving, and shrink back to a small size while at rest
	Pointer tails	When enabled, ghost images follow the pointer to increase visibility on LCD screens; can also adjust tail length

ActionPoint configuration panels (continued)

Panel	Features	Description
Motion settings	Sensitivity	Adjusts the response of the pointer to the motion of the pointing device
	Double-click speed	Adjusts how quickly you must double-click
	Acceleration	Increases the cursor speed in relation to sensitivity settings
	Extra precision	Lets you shift the screen pointer temporarily into one of four special-purpose operating modes: slow motion, freeze motion, horizontal motion, and vertical motion
Orientation settings	Set rotation	Adjusts the direction of the cursor
	Set buttons	Lets you swap left and right buttons
Shortcuts settings	Autojumps	Sets the pointer to jump to a predefined location whenever a dialog box opens
	Hotspots	Sets the pointer to jump to a predefined location when you press a key combination
	Custom assignments	Lets you assign key combinations to predefined keyboard and mouse actions

ActionPoint configuration panels (continued)

Panel	Features	Description
Touchpad settings	Edge motion	Lets you extend cursor motion when your finger reaches the edge of the touchpad
	Touch threshold	Controls how much finger pressure you must apply before the touchpad responds
	Gestures	Lets the touchpad recognize several tapping gestures that replace right or left mouse button clicks

To select a setting click the button for that setting then adjust the controls.

When you've made changes, click OK to exit. Your settings take effect immediately.

Customizing Computer Settings

Setup configures your ActionNote and stores the settings in the computer's CMOS ROM (read-only memory) Because this area of memory is backed up by a battery, it is not erased when you turn off or reset the computer.

The current configuration is probably fine for most of your needs. However, you may need to run Setup when you upgrade your computer or connect new equipment You can also run Setup to customize power management.

Starting Setup

To start Setup, turn on your computer. (If your computer is already on, save any files you've been working on, then restart your computer.)

During power-on diagnostics you see the following prompt:

Press F8 to run SETUP

As soon as you see this message, press F8

If you do not press F8 within 5 seconds, the computer loads the operating system. You can restart the computer and try again.

Changing the Settings

When the computer starts Setup, you see the Page 1 screen, which displays your computer's memory configuration in addition to other settings you can change. Base memory plus extended memory is total system memory.

Use the right, left, down, and up arrow keys to move the cursor from option to option. Once you have highlighted an option you want to change, press the + or - key to scroll through the settings and select the one you want. Press PgDn or PgUp to go to the next or previous Setup screen.

Help information is available for each option. Highlight the option you want to change and press F1 to get Help.

Setup lets you change or verify the settings listed in the following tables.

Setup page 1 options

Setting	Options	Description
System Time	hh:mm:ss (24 hour format)	Sets the time used by the system
System Date	mmm dd, yyy	Sets the date used by the system
Update Flash	Enabled Disabled*	Lets you upgrade your BIOS horn a diskette
Hard Disk 1	Auto (automatically detected)* user None	Sets the type of drive installed of allows you to define the type
CPU Speed	Fast* slow	Sets the processor speed
Quick Boot	Disabled* Enabled	Lets you skip non-essential diagnostic tests at startup
Boot Drive	C:, A A:, C*	Sets the drive from which the operating system will be loaded at startup
Password	Disabled Enabled	See 'Setting or Changing a Password- below
Security	Setup* system	Applies password protection to entire system or Setup only
Boot Display	Auto* Simul	Sets the display mode at startup; Auto lets the system select the LCD screen or monitor (if connected); Simul displays on both

*Default setting

The table below lists the page 3 Setup options.

Setup, page 3 options

Setting	options	Description
Internal Cache	Enabled*	Controls the processor's internal cache operation
	Disabled	
External Cache	Enabled	Controls the processor's external cache operation when external cache is installed
	Disabled*	
Serial Port	3F8h (COM1)*	Assigns the serial port address
	2F8h (COM2)	
	Disabled	
Fax/Modem	3F8h (COM1)	Assigns the port address for the fax/modem when it is installed
	2F8h (COM2)*	
	Disabled	
Parallel Port**	378h (LPT1)*	Controls the parallel port operation
	Disabled	
Audio I/O	220*	Identifies the I/O address the audio card uses
	230	
	240	
Audio IRQ	5*	Identifies the IRQ setting the audio card uses
	7	
	9	
	10	
Pointing Device	Enabled* Disabled	Lets you die the built-in touchpad, in case you connect a serial mouse

* Default setting

** Autodetects ECP or EPP devices when connected and turned on at system start-up

The table below lists the power management options. Additional information about power management follows the table.

Power management options (Setup page 2)

Setting	Options	Description
Power Management	Enabled Disabled AC Disabled*	Lets you enable power management at all times, disable it completely, or disable it only when you use an adapter
System Idle	Disabled Enabled*	Lets you disable the Idle mode
System Standby	Disabled 1 to 15 minutes; 2 minutes*	Lets you disable or set the period of inactivity before the Standby mode takes effect
System Suspend	Disabled 1 to 15 minutes; 10 minutes*	Lets you disable or set the period of inactivity (following the Standby period) before the Suspendmode takes effect
Hard Disk Timeout	Disabled 1 to 15 minutes; 5 minutes*	Lets you disable or set the period of in activity before the hard disk drive turns off
Screen Timeout	Disabled 1 to 15 minutes; 2 minutes*	Lets you disable or set the period of inactivity before the screen turns off
Low Battery	Save to HDD Disabled	See 'Customizing Power Management' below
Instant On	Enabled Disabled*	See 'Customizing Power Management' below

*Default setting

When you are ready to exit Setup, press Esc. You see the exit menu. Press one of the following keys:

Setup exit command keys

Key	Description
ESC	Returns you to the main Setup or Power Management Setup screen
F4	Saves your new settings and restarts the computer
F5	Loads the default settings for all the options and returns to Setup
F6	Exits Setup without saving your settings

Customizing Power Management

In addition to the timeout options listed above, the Power Management screen also lets you press one of the following function keys to configure your timeout options

Function key	Description
F2	Selects Maximum Performance mode; maximizes system performance in all power management states, but allows some features to power down
F3	Selects Maximum Battery mode; minimizes battery usage and decreases system performance in low power states

You may want to experiment to find the settings that work best for you. You can access the Power Management screen (without running Setup) by pressing Fn F8, so you can adjust your settings at any time.

You should not, however, change the Power Management and Low Battery options. These features protect your data when your battery is about to run out.

For more information about how your power management features work, see “Using Power Management” in Chapter 2.

Using Instant On and Saving to Disk

The Low Battery option in Setup allows you to select Suspend or Save to HDD, which perform the following functions

Mode	Description
Suspend	The computer continues to use a very small amount of power. If you select Suspend and leave your system suspended, the battery eventually runs down and your data will be lost.
Save to HDD	Contents of your system and video memory are saved to a special partition on your hard disk drive. Even if your battery <i>MS down</i> , your data is protected.

Instant On works through the same process as Save to HDD, except that your data is saved to disk when you press the Suspend/Resume

button Before you can use either of these features, you have to configure your hard disk drive.

The drive is already partitioned to set aside a 25MB area for the saved data (allowing space for all memory configurations). This area is invisible to your software, and the amount of disk space available to you for normal data storage is reduced

If you need to partition a drive, for example if you install a new one, copy the utility into the PM directory; then run the PHDISK utility program by typing the following commands at the DOS prompt:

```
CD\PM  
PHDISK/CREATE
```

The PHDISK program formats the partition on your hard disk drive. After you run this program, you can use the Save to Disk and Instant On functions available on the Power Management screen. These options take effect immediately. You might need to run this utility again if you change the memory size.

Using Password Security

This section tells you how to set up a password to prevent unauthorized people from using your ActionNote.

NOTE

Remember that once you set a system password, you cannot access your system unless you enter it correctly. Write down your password and keep it in a safe place. If you forget it, call the EPSON Connection for assistance.

Setting or Changing a Password

You can set two types of passwords for your computer: a system password and a Setup password

If you set a system password, the computer prompts you to enter it each *time you turn on* or reset your computer. If you set a Setup password, the computer prompts you to enter it each time you press F8 to run Setup.

Follow the instructions in the next sections to set, delete, or change your password See "Entering a Password" in Chapter 3 for information on using a password

Setting a Password

Follow these steps to set a password

1. Highlight the **Password** option.
2. **Press Enter.**
3. Type a password up to seven characters long. As you type, you see only symbols displayed on the screen.
4. **Press Enter.**
5. Type the password again and press **Enter.** (If you enter an incorrect password, you must start the process over again. Keep trying until you have entered the password correctly twice in a row.)
6. Press any key to continue. The Password option setting is enabled.
7. You can now highlight the Security option and select **SETUP**, which applies the password to the Setup program. You can also select **SYSTEM**. If you select **SYSTEM**, you are prompted to enter the password whenever you turn on the computer or run Setup.

Deleting or Changing a Password

If you want to delete or change a password, follow these steps:

1. Highlight the **Password** option
2. **Press Enter.**
3. Type your password. You see only squares on the screen
4. **Press Enter.**
5. If you are deleting your password, press the / key. The Password option setting is changed to **Disabled**

If you are changing your password, type the new password You see only squares displayed on the screen

6. **Press Enter.**
7. Type the password again and press Enter.
8. Press any key to continue.

.....

Using Video Drivers and Utilities

Your system includes high-resolution video display drivers for Windows[®] installed on your hard disk drive. If you are using Windows 3.1, you can use these drivers to

display in resolutions up to 1024 x 768 in 16 colors on an external monitor. Windows 95 provides the Chips and Technology drivers to do the same thing. To select these drivers, use your operating system's video display or control panel utility.

If you select a higher resolution for your LCD screen, your display is larger than the screen itself. As you move your cursor up and down and from side to side, the screen pans to show the entire display.

NOTE

Your Action/We is configured to display in standard VGA resolution on your LCD or an external monitor. You can toggle between displaying on the LCD, on the external monitor, or on both screens simultaneously by pressing Fn F10. You can also set the default video mode by using Setup; see "Changing the Settings" for more information.

To check on the availability of drivers for non-Windows applications, call the EPSON Connection or access one of the EPSON electronic support services, as described under "Where to Get Help" in Chapter 7.

7 *Troubleshooting*

You probably won't have any problems as you set up and use your ActionNote. If anything out of the ordinary happens, however, see this chapter for help.

..... Where to Get Help

If you purchased your computer in the United States or Canada, EPSON provides customer support and service through a network of Authorized EPSON Customer Care Centers. EPSON also provides the following services when you dial (800) 922-8911.

- Technical information on the installation, configuration, and operation of EPSON products
- Assistance in locating your nearest Authorized EPSON Reseller or Customer Care Center
- Customer relations
- EPSON technical information library fax service
- Product literature on current and new products.

You can purchase printed manuals, accessories, or parts for EPSON products from EPSON Accessories Call (800) 873-7766 (U.S. sales only) from 6:00 a.m. to 6:00 pm. Pacific time. In Canada, call (800) BUY EPSON.

If you purchased your computer outside the United States or Canada, contact your EPSON dealer or the marketing location nearest you for customer support and service.

If you need help with any application program you are using see the documentation for that program for technical support information.

Electronic Support Services

If you have a modem, the fastest way to access helpful tips, specifications, drivers, application notes, and bulletins for EPSON products is through the online services below.

NOTE

*To access electronic support services, you must have a modem. You can install **an internal fax modem**, a **fax/modem PC card**, or connect **an external modem to you serial** port.*

EPSON bulletin board service

You can call the EPSON bulletin board service (BBS) 24 hours a day at (310) 782-4531. No membership is required. Make sure your communications software is set to 8 data bits with no parity and 1 stop bit, and any modem speed up to 28.8 Kbps. See the documentation that came with your communications software for more information.

CompuServe's EPSON America Forum

EPSON also maintains the EPSON America Forum on CompuServe.[®] If you have questions about your EPSON product, this is a good place to get them answered.



Your computer includes the CompuServe WinCIM[®] Information Manager[®] installed on your hard disk drive and a free trial subscription to CompuServe's services and forums. The brochure that comes with your ActionNote describes all the CompuServe services and how to access them, as well as providing subscription information.

To access the EPSON America Forum in WinCIM, simply click on the green traffic light icon and type EPSON at the menu prompt.

Identifying Your System

When you request technical assistance, be ready to provide the following

- EPSON product name and model (on the logo for your ActionNote)
- EPSON product code (Axxxxxx)
- Serial number (on base of ActionNote)
- System BIOS version (displayed during startup)
- System configuration information from Setup
- Operating system version number
- Hardware configuration (connections to external devices, memory size, and so on)
- Names and version numbers of software you're using
- Any installed options
- Any error message displayed

Once you gather this information, write it down at the back of this manual to keep it handy whenever you need it.

.....

Error Messages

Your computer contains power-on diagnostics that check internal devices every time you turn it on. If the computer finds an error, it displays an error message on the screen. Many error messages suggest a remedy. For example, if you have installed a component, you might need to check that it was installed correctly.

If the error is serious, the error message remains on the screen and the computer locks up. If this happens, contact your Authorized EPSON Servicer or the EPSON Connection

.....

Troubleshooting Your ActionNote

If you have trouble with your ActionNote, look through the headings in this chapter to see if the problem is covered. Then follow the suggestions to see if you can solve the problem. If your computer is still not working correctly, call (800) 922-8911 or access any of the electronic support services described earlier in this chapter.



The Computer Won't Start

The computer won't start when you press the on/off button.

- If the Power light is on, check the Suspend light. Press any key if it is on; press the **Suspend/Resume** button if it is flashing
- Check the Power light. If it is flashing green, it means the battery is too low to power the computer.
- Make sure the brightness and contrast controls are not turned down. If an external monitor is connected, make sure it's turned on
- If you replaced your hard disk drive, make sure you installed it correctly.
- **Turn** off the computer. If you are using the battery, remove it and reinstall it. If you are using an AC power adapter, disconnect it and then reconnect it. Then **turn** the power **on** again

You have trouble running the computer from a battery

- The battery power may be low. If you have a second fully charged battery, use it to replace the one in the computer and recharge the original battery.

- ❑ If you replace the battery and the computer does not work properly, the new battery may also not be fully charged. Recharge it.
- ❑ When the charge light is flashing orange, the battery may not be installed properly. Try removing and reinstalling it.
- ❑ Connect the AC power adapter to the computer and plug the adapter into an electrical outlet. If you have not used the battery in a long time (three months or more), you may need to recharge it.

When you find that, over time, the battery is losing its charge faster, it may be reaching the end of its life. You may need to replace it with a new battery.

NOTE

When you need to discard your battery, contact your local government agency for information about recycling NMH batteries.

The computer doesn't work properly with the AC power adapter.

- ❑ Make sure the **AC** power adapter is securely connected to the computer and the electrical outlet.

- Make sure the electrical outlet is supplying power. If the outlet is working there may be something wrong with your AC power adapter.

The LCD Screen is Blank

- Use the brightness and contrast controls to adjust the screen display. See “Adjusting the Screen Controls” in Chapter 1.
- You may have switched your display to external monitor mode. Press Fn F10 until you see the display on your LCD screen. Make sure the default display selected in Setup and the setting in the video display control panel utility are correct for your system. See “Using Video Drivers and Utilities” in Chapter 6.
- The computer may be in Suspend mode; press any key or the Suspend/Resume button to resume. Press the on/off button to resume if you are using Instant On See Chapter 2 for more information.
- You may have set a timeout period for the LCD screen in Setup or with your operating system. This turns off the screen after a specified period of time has elapsed with no system activity. Press any key to restore the display. (See “Using Power Management” in Chapter 2.)

The Computer Locks Up

- Some operations take longer than others to perform. Wait a few minutes to see if the computer returns to normal operation.
- The computer may be in Standby or Suspend mode. Press any key or the **Suspend/Resume** button to resume activity.
- Try pressing the **Num Lock** key. If the Num Lock light does not come on, the computer is probably locked up.
- You may be able to resume activity by cancelling the current operation. Press **Ctrl Alt Del**. Then follow any instructions on the screen
- Turn off the computer, wait thirty seconds, and turn it back on

Your Password Isn't Working

- If you type the password and then see the password prompt again, type the password again and press **Enter**.
- If the computer locks up, turn it off, wait 30 seconds, and try again
- If you have forgotten your password, call the EPSON Connection for assistance.

You Can't Access Data on a Diskette

- Remove the diskette and make sure it is inserted with the label facing up.
- Make sure the diskette is either 720KB or **1.44MB**.
- If the write-protect switch is set, and you are trying to save a file to the diskette, either use a different diskette, or move the writeprotect switch
- If the diskette is damaged, use a backup copy to repeat the operation. If you need the files on the original diskette, try copying one file at a time.
- Try cleaning the diskette drive heads. See “Cleaning the Diskette Drive” in Chapter 4.
- Try formatting a new blank diskette to determine whether the problem is with the diskette or the drive. See your operating system documentation or online help for instructions

The Diskette Drive Isn't Working

- Try reading from or writing to the diskette in another computer's drive, if you have access to one.

- If the drive is making loud or unusual noises, contact your Authorized EPSON Servicer or the EPSON Connection

You Can't Access Files on the Hard Disk Drive

- If you have set a timeout for the hard disk drive in Setup and the drive powered down, it may still be coming back up to speed. Your drive takes about 15 seconds to resume speed.
- Make sure the Hard Disk option is set correctly in Setup. If your hard disk drive is not detected, you will have to configure the appropriate hard disk drive parameters yourself.
- If you replaced or upgraded the hard disk drive, make sure it is installed correctly and that the operating system is installed. See "Upgrading the Hard Disk Drive" in Chapter 5.

A PC Card Isn't Working

- The PC card slots on your computer support PCMCIA version 2.1 or earlier and accept up to two Type I or II cards, or one Type III card. If you aren't sure your card

is compatible, call the EPSON Connection or your Authorized EPSON Servicer for the latest information about tested cards.

- Like a diskette, a new PC RAM or hard disk card may need to be formatted (initialized) before you can use it. See the documentation that came with your card or driver for instructions.
- Press the release button to remove the card; then try inserting it again. See “Using PC Cards” in Appendix B for instructions.
- Your computer is set up to work with most PC cards, but some cards require that you install other software drivers. See the documentation that came with your card

The ActionNote comes with PCMCIA drivers and utilities that you can use with your card. Your operating system may also include drivers. For details, see “Using PC Cards” in Appendix B.

- You may need to restart your computer and select the appropriate option at the PCMCIA driver prompt. Then try your PC card operation again.
- When you resume from Suspend to Disk mode, your PCMCIA drivers may not be reloaded or reinitialized. Exit any application programs you are using and

restart your computer; then, if necessary, select the option to load your PCMCIA card drivers at the prompt.

See the EPSON PCMCIA Card Software User's **Guide** for information about configuring PC cards using the drivers supplied with your computer. If none of these solutions solve your problem, contact the card manufacturer or call your Authorized EPSON Servicer or the EPSON Connection for assistance.

The ActionPoint Isn't Working Correctly

- Make sure the touchpad has not been disabled in Setup. See “Changing the Settings” in Chapter 6 for instructions.
- Make sure the touchpad drivers are loaded and the ActionPoint is configured the way you want. See “Customizing Your ActionPoint” in Chapter 6 for more information.
- The touchpad is highly sensitive to moisture. Clean the ActionPoint (see “Cleaning your ActionNote” in Chapter 4); then wash and dry your hands.
- If you still have trouble with the ActionPoint, contact your Authorized EPSON Servicer or the EPSON Connection.

An External Monitor Is Blank

- Adjust the brightness and contrast of the monitor screen
- Check that the monitor's power cable is securely connected to the monitor and to an electrical outlet.
- Make sure the monitor is set for the correct input and can support the video mode you have selected. See your monitor manual for more information.
- You may have switched your display to LCD mode. Press Fn F10 until you see the display on your external monitor.
- If the monitor still does not work, turn off both the computer and the monitor. Then check the electrical outlet for power.
- Contact your Authorized EPSON Servicer or the EPSON Connection for assistance.

An External Pointing Device Doesn't Work

- If you have disabled the pointing device in Setup, make sure your new pointing device driver is installed and loaded. See the documentation that came with your device for instructions.

- Your ActionPoint touchpad is disabled when you connect a device to the external keyboard/mouse port and use it before you use the touchpad.

If you connect a pointing device to the serial port (rather than the mouse port), however, you must disable the touchpad in Setup. See “Changing the Settings” in Chapter 6 for instructions

- Make sure you connected the device to the external keyboard/mouse port (or serial port) before you turned on the computer, as described in “Using an External Keyboard, Mouse, or Other Pointing Device” in Appendix B.
- If the device is connected to the computer’s serial port, make sure the device and the serial port options in Setup are set to use the same memory address or COM port See “Changing the Settings” in Chapter 6 for more information
- If you still have trouble with an external device, check the manual that came with it or contact the manufacturer.

Your Printer Isn't Working

- ❑ If you have just connected the printer, check that the printer has power and is properly connected to the computer.
- ❑ If you have a serial printer or if you have problems feeding paper, check the printer manual for the correct DIP switch settings and settings for serial operation.
- ❑ Check the settings in your software to make sure the correct port is selected

The Memory Count Is Incorrect

Reinsert the memory module following the instructions under “Installing a Memory Module” in Chapter 5.

Your Software Isn't Working Correctly

- ❑ If the application program does not start, check that you are following the correct procedure for starting the program, and that it is installed correctly.
- ❑ If it's available, see the software's online to help you diagnose the problem.
- ❑ Your computer can run at either high speed or low speed. While almost all programs work properly at high speed, some must run at the slower speed. Check

your software manual to see if this is the case, and change the CPU Speed setting in Setup if necessary. See “Changing the Settings” in Chapter 6 for details.

- If you have entered a command that you want to stop, press **Ctrl Alt Del** and follow the instructions on the screen
- An application program can occasionally lock up the computer. If your computer does not respond when you press the **Num Lock** key, turn off your computer, wait 30 seconds, and then turn it back on and restart your application program.
- If none of these solutions solves your software problem, contact the software manufacturer for technical support.

Your Optional Infrared Port Isn't Communicating

- Make sure you have the infrared utility software running and check the software utility's communications indicator to see if the port is active The IrDA device polls for data until it finds another IrDA signal
- To check that it is communicating hold a mirror up to the port so that it receives its own reflected signal The signal will show in the utility software's indicator.

- ❑ Check that there is no obstruction between the ActionNote IrDA port and the receiving device's IrDA port. There must be a clear line of sight between the two communicating ports.
- ❑ Make sure that the communicating IrDA ports are within three feet of each other, and are positioned at a 30° angle.
- ❑ Check that the IrDA port's COM assignment is correct. The default setting is COM2.

A Specifications



CPU and Memory

<i>CPU</i>	486 DX4 microprocessor installed in a PGA socket; includes 8KB of internal cache in write-back mode and integrated math coprocessor
<i>System speed</i>	Fast speed and slow speed selectable in Setup
<i>Memory</i>	8MB RAM <i>on</i> the system board expandable up to 24MB using a 4, 8, or 16MB memory expansion module
<i>ROM</i>	128KB Flash ROM device containing the system and video BIOS and Setup program code. The BIOS is shadowed in DRAM for faster access
<i>Video RAM</i>	512KB DRAM supports resolutions up to 640 by 480 in 256 colors on LCD and up to 1024 by 768 in 16 colors or 800 by 600 in 256 colors on external monitor
Cache	8KB internal
Clock/calendar	Real-time clock, calendar, and CMOS RAM; backed up by internal battery

Controllers

Video	Chips and Technology® 65535 video controller; 1MB DRAM; 32-bit VL Local bus; supports 640 by 480 in 256 colors on LCD 800 by 600 in 256 colors or 1024 by 768 in 16 colors on external monitor; automatic external monitor detection; simultaneous display with LCD screen using Fn F10 command or software
Diskette drive	Super I/O controller for one internal 3.5-inch diskette drive; supports 720KB and 1.44MB formats
Hard disk	Super I/O controller has interface for one internal hard disk drive; automatically recognizes and configures drives that support the IDE interface
PCMCIA	Built-in Vadem® VG-468 controller for two stacked slots supports two Type I or II cards or one Type III; PCMCIA version 2.01 and JEIDA 4.1 compatible; supports low power and suspend modes; supports hot insertion (including ExCA standards) register compatible with Intel® 82365SL

Interfaces

External VGA

Auto-sensing, 15-pin, D-sub, female connector for analog monitor, supports simultaneous display with LCD using Fn F10 hot key sequence or software command

Parallel

Centronics® compatible; 25-pin, D-sub, female connector, bidirectional 8-bit parallel; autodetects ECP or EPP devices when connected and turned on at system start-up

Serial

RS-232C, programmable, asynchronous, 9-pin, D-sub male connector

External keyboard/mouse

Auto-sensing, 6-pin, mini-DIN connector for a PS/2-type external keyboard, keypad, or pointing device

Phone jock

Standard RJ-11 connector with optional internal send/receive fax/modem installed

Infrared

Supports optional IrDA-compliant interface; up to 115.2 kbits/second to a distance of 3.3 feet (1 meter) within a 30° viewing angle; can use COM1 (3F8h) or COM2 (2F8h)

Speaker	Internal; automatically disabled when the audio output port is used with the optional audio cord
Audio input and output	Connectors for stereo line-in, stereo line-out and for monaural microphone when optional audio card is installed; IRQ 5 (default), 7, 9, or 10; I/O address of 220 (default), 230 or 240
Port replicator	Connector for ActionPort™ Replicator
Security	Connector for security cable

Keyboard

85 keys 101-key keyboard compatible; embedded numeric keypad; Fn key for hot key commands

ActionPoint Touchpad

Built-in pointing device with two buttons compatible with PS/2 mouse driver software; can be disabled with Setup

Volume Control

Knob adjusts sound of internal speaker or audio card (if installed)

Mass Storage

Hard disk drive

Removable internal IDE hard disk drive, 2.5-inch form factor; maximum height 19 mm; Setup automatically recognizes and configures drives that support IDE interface

Diskette *Drive*

Internal 3.5-inch diskette drive; 720KB or 1.44MB format; supports lower power consumption

LCD Screen

Screen type (all backlit)	Resolutions and color	Active area, diagonal measurement
Monochrome	640 by 480, 64 gray shades	9.5 inches
Passive color	640 by 480 256 colors	10.4 inches
Active color	640 by 480 256 colors	10.4 inches

Setup Program

Stored in ROM; accessible by pressing F8 at system startup; includes power management utilities.

Software

See the Software Support icon in the About My ActionNote folder or group for the latest information about the software included with your system and installed on the hard disk drive

Power Sources

Sources include internal removable battery, lightweight AC power adapter, or optional international AC power and automobile adapters

Battery

Rechargeable 12 Volt NiMH battery, current regulation by thermistor

AC Power Adapter

Specification	Lightweight AC power adapter	International AC power adapter
AC Connection	2 folding connectors	6 ft (1.8 meter) cable
DC cable	6 ft (1.8 meters)	6 ft (1.8 meters)
Input voltage	100 VAC to 250 VAC	100 VAC to 250 VAC
Input frequency	40/63 Hz	40/63 Hz
Output voltage	19 VDC, 1.23 Amp maximum	19 VDC, 1.5 Amp maximum

AC Power Adapter Dimensions

Dimension	Lightweight AC power adapter	International AC power adapter
Length	3.4 inches (86 mm)	4.7 inches (120 mm)
Width	2.2 inches (56 mm)	2.04 inches (60 mm)
Height	1.1 inches (28 mm)	1.5 inches (37 mm)
Weight	7.8 oz (220 g)	9 oz (255 g)

CAUTION

Use on/y the adapters and replacement batteries designed for use with the ActionNote 890 series.

Fax/Modem Specifications

Characteristic	Fax	Modem
Compatibility	Group 3, CCITT G3 V.2.1, V.27ter, V.29 (send only)	Bell 103, 212A. CCITT V.22, V.22 Bis
speeds	14.4K, 9600, 7200, 4800, 2400, 300 baud	14.4K, 9600, 2400, 1200, 300 baud
Command set	Class 1	Enhanced AT
Data correction	MNP 2 to 4, V.42	
Data compression	MNP 5, V.42 bis	
Dialing type	Touchtone or pulse	

Environmental Requirements

Condition	Operating	Non-operating
Temperature	42° to 95° F (5° to 35° C)	-4° to 140° F (-20° to 60° C)
Humidity (non-condensing)	30% to 90%	5% to 95%
Altitude	-200 to 12,000 ft (-67 to 4,000 m)	-200 to 30,000 ft (-67 to 9,000 m)
Acoustical noise	35 dB at 1 meter (maximum)	

CAUTION

When traveling by airplane, take the computer into the passenger compartment as carry-on luggage to prevent it from being stored in an unpressurized storage compartment.

Physical Dimensions

Dimensions*	U. S	Metric
Depth	8.8 in	220 mm
Width	11.7 in	292 mm
Height	1.7 in (1.6 in)	43 mm (40 mm)
Weight	6 lb (5.5 lb)	2.5 kg (2.5 kg)

- * Dimensions for monochrome ActionNote are given in parentheses

A-8 Specifications

Index

A

AC adapter

- connecting 1-3
- dimensions A-7
- input ranges, 1-3
- International, 1-3, 2-2
- model numbers, 2-2
- precautions 4-1
- specifications A-6
- using 1-2, 2-1

Adapter, automobile, 2-2

Adapter, see AC adapter

Audio

- input/output, A-4
- volume control, A-4

Automobile power adapter, 2-2

B

backing up files, 4-2

Battery

- charging 1-2, 2-1, 2-3-2-4
- checking status 1-4
- configuration, 2-7
- conserving power, 1-6, 2-2, 2-5
- external charger, 2-3-2-4
- indicator light, 1-5, 2-1
- Instant On, 5-6
- losing power, 2-3
- low power protection, 2-6
- NiMH, 2-3
- operating in Suspend mode, 2-6
- recharging 1-4, 2-3
- reconditioning 2-3
- recycling, 2-5**
- replacing, 2-3-2-5

Battery (continued)
 Save to Disk 5-6
 specifications A-6
 using 2-2-2-5
Boot password, 6-12
Brightness 1-6

C

Cache, A-1
Calendar, A-1
Caps Lock indicator light 1-5
Charge light 2-1
Cleaning the computer, 4-4
Clock, A-1
CompuServe, 7-3
Computer specifications, A-1-A-8
Contrast 1-6
Controllers, A-2
CPU specifications A-1
Customization
 computer settings, 6-3-6-8
 power management, 6-8-6-10
 security, 6-11-6-13
 touchpad, 6-1

D

DC-in port 1-3
Dimensions
 computer, A-8
 hard disk drive, 5-1
Disk Creation Utility, 1-10
Diskette drive
 cleaning 4-4
 controller, A-2
 indicator light, 1-5
 problems accessing, 7-10
 specifications, A-5
Diskettes
 inserting 3-2
 size, 3-2
 software, 1-10

E

Energy, conserving, 2-8

Environmental requirements, A-8

EPSON

Accessories 7-2

bulletin board, 7-2

Connection 1-1

Customer Care Centers, 7-1

electronic support service, 7-2

parts 7-2

services 7-1

Ergonomics, 3-4

Error messages 7-5

External battery charger, see Battery

External monitor, see Monitor, external

External pointing device, see Pointing device

External VGA, see VGA

F

Fax/modem

command set 5-18

connecting phone, 5-17

FDISK utility, 5-6

Features, 1-1

Files, backing up, 4-2

Fn key functions, 1-8

Function keys

F8, 6-4

Power Management 6-9

sticking 5-11

G

Green light flashing, 2-6

H

Hard disk drive

- controller, A-2
- dimensions 5-1
- indicator light, 1-5
- partition, 6-10
- precautions 4-2
- problems, 7-11
- removing, 5-2
- replacing, 5-4
- specifications, A-5
- timeout 2-5
- upgrading 5-1-5-6

I

- Indicator Lights 1-4, 1-5
- Infrared, 5-14-5-17, A-3
- Instant On feature, 2-7, 6-9-6-10
- Interface specifications A-3-A-4
- IrDA, 5-14-5-17, A-3

K

Keyboard

- embedded numeric keypad, 1-9
- external, A-3
- Fn key functions 1-8
- layouts 1-8
- removing, 5-7-5-9
- replacing, 5-10-5-11
- specifications A-3-A-4
- using 1-8

Keypad, embedded, 1-9

L

LCD screen

- cleaning 4-4**
- drivers and utilities, 6-13
- precautions, 4-1
- resolution, 6-13
- specifications A-5
- timeout 2-5

Low Battery option, 6-9

M

Mass storage, see Diskette drive, Hard disk drive

Memory

- capacity, 5-11
- module, 5-12
- problems 7-16
- specifications, A-1
- upgrading 5-11-5-14

Model number, 7-4

Moisture, 4-4

Monitor, external, 6-14, 7-14

Mouse problems, 7-14

Moving the computer, 4-3

N

NiMH battery, 2-3

Num Lock

- indicator light 1-5
- key, 1-9

O

On/off button, 1-4

Opening your computer, 1-2

P

Parallel interface, A-3

Parallel port, enabling 6-6

Password

- changing, 6-13
- deleting 6-13
- entering 3-1
- incorrect 3-2
- losing** 6-11
- problems, 7-9
- setting** 6-11-6-12
- setup 6-11
- system, 6-11
- types, 3-1, 6-11**
- using 3-1-3-2**

PC card

- controller, A-2
- indicator light, 1-5
- problems 7-11

PCMCIA, see PC card

PHDISK utility, 5-6, 5-11, 6-10

Phone line, connecting, 5-17

Pointing device, see Keyboard, Mouse, Touchpad

Ports, enabling, 6-6

Power

- AC adapter, 1-2, 1-4
- automobile adapter, 2-2
- battery, 1-2
- conserving 1-6, 2-5-2-8
- consumption with battery, 2-2
- function keys 6-9
- hard **disk** drive, 4-2
- Instant On feature, 2-7, 6-7, 6-9-6-10
- Low Battery option, 6-9
- low battery protection 2-6-2-7
- managing 2-5-2-6, 6-8-6-10
- precautions, 4-1
- recharging 2-3
- replacing battery, 2-7
- resume mode, 2-6
- saving to disk, 6-9-6-10
- sources, A-6
- suspend mode, 2-5
- turning on and off, 1-4

Power modes 2-5

Precautions

- computer, 4-1
- diskette drive, 4-4**
- hard disk drive, 4-2
- touchpad, 4-4
- when traveling 4-3

Printer

- enabling port 6-6
- problems, 7-16

- Problems, 7-6-7-17
 - diskette drive, 7-10
 - external monitor, 7-14
 - hard disk drive, 7-11
 - memory, 7-16
 - password, 7-9
 - PC card, 7-11
 - printer, 7-16
 - software, 7-16
 - touchpad, 7-13
- Product code, 7-4
- Protection, see Password Security
- Q**
- Questions, 1-1
- R**
- Recharging the battery, 2-3
- Replacing the battery, 2-4
- ROM, A-1
- S**
- Save to HDD mode, 6-9
- Screen controls 1-6
- Screen timeout 2-5
- Scroll Lock, indicator light, 1-5
- Scrolling 6-14
- SCU password 6-12
- Self-test 1-4
- Serial interface, A-3
- Serial number, 7-4
- Serial port, enabling 6-6
- Software
 - diskettes, 1-10
 - problems, 7-16
- Speaker, A-4
- Specifications, computer, A-1-A-8
- Storing the computer, 4-3
- Strain, avoiding, 3-4
- Suspend/Resume function 2-5, 6-10
 - in Windows 95, 2-6
- Switches, contrast and brightness 1-6

T

Telephone, see Phone line, connecting

Temperature ranges 4-3

Timeout, 2-5

Touchpad

cleaning 4-4

clicking 1-7

compatibility, 1-6

configuring 6-1

mouse equivalents 1-7

problems, 7-13

selecting an item, 1-7

specifications A-4

using **1-6**

Troubleshooting 7-1-7-17

error messages 7-5

function keys sticking 5-11

Turning computer on and off, 1-4, 4-1

Typing avoiding strain 3-4

U

Upgrading hard disk drive, 5-1

V

VGA, A-3

resolution, 6-14

Video

controller, A-2

drivers and utilities, 6-13

RAM, A-1

resolution, 6-13, 6-14

specifications A-5

Volume control, A-4

W

Wrist rest, 3-4