

Dell Precision™ Mobile Workstation M40 User's Guide

About Your Computer

[What You Need to Know](#)
[Features and Options](#)
[Front View](#)

Setup and Operation

[Using Your Computer](#)
[Connecting Devices](#)
[Passwords and Security](#)
[Traveling With Your Computer](#)
[Removing and Replacing Parts](#)

Powering Your Computer

[AC Adapter and Battery](#)
[Conserving Power](#)

[Using the System Setup Program](#)

[Reinstalling Software](#)

Solving Problems

[Finding Solutions](#)
[Dell Diagnostics](#)
[Understanding Error Messages](#)

Getting Help

[Help Overview](#)
[Contacting Dell](#)

[Technical Specifications](#)

Additional Information

[Regulatory Notices](#)
[Warranty and Return Policy](#)

Model PP01X

Notes, Notices, and Cautions



NOTE: A NOTE indicates important information that helps you make better use of your computer.

NOTICE: A NOTICE indicates either potential damage to hardware or loss of data and tells you how to avoid the problem.



CAUTION: A CAUTION indicates a potential for property damage, personal injury, or death.

Information in this document is subject to change without notice.
© 2001 Dell Computer Corporation. All rights reserved.

Reproduction in any manner whatsoever without the written permission of Dell Computer Corporation is strictly forbidden.

Trademarks used in this text: *Dell*, *Dimension*, *Dell Precision*, *Latitude*, *Inspiron*, *OptiPlex*, *ExpressCharge*, *HyperCool*, *DellWare*, *TrueMobile*, *DellNet*, and *AccessDirect* are trademarks of Dell Computer Corporation; *Microsoft*, *Windows*, and *MS-DOS* are registered trademarks of Microsoft Corporation; *3Com* is a registered trademark of 3Com Corporation; *Intel* and *Pentium* are registered trademarks of Intel Corporation; *Quadro2 Go* is a trademark of NVIDIA Corporation; *ENERGY STAR* is a registered trademark of the U.S. Environmental Protection Agency. As an *ENERGY STAR* partner, Dell has determined that this product meets the *ENERGY STAR* guidelines for energy efficiency.

Other trademarks and trade names may be used in this document to refer to either the entities claiming the marks and names or their products. Dell disclaims any proprietary interest in trademarks and trade names other than its own.

The following product notice applies to the Macrovision Corporation product that is included with the DVD drive:

This product incorporates copyright protection technology that is protected by method claims of certain U.S. patents and other intellectual property rights owned by Macrovision Corporation and other rights owners. Use of this copyright protection technology must be authorized by Macrovision Corporation, and is intended for home and other limited viewing uses only unless otherwise authorized by Macrovision Corporation. Reverse engineering or disassembly is prohibited.

September 2001 1K409 A00

[Back to Contents Page](#)

AC Adapter and Battery: Dell Precision™ Mobile Workstation M40 User's Guide

[About the AC Adapter](#)

[Connecting the AC Adapter](#)

[About the Batteries](#)

[Removing a Battery](#)

[Installing a Battery](#)

[Checking the Battery Charge](#)

[Battery Warnings](#)

[Charging the Battery](#)

[Detecting Battery Problems](#)

[Battery Disposal](#)

About the AC Adapter

- 1 You can connect the AC adapter with your computer either turned on or off.
- 1 The AC adapter works with electrical outlets worldwide. However, power connectors vary among countries. Before you use AC power in a foreign country, you may need to obtain a new power cable designed for use in that country.
- 1 If the computer is connected to a Dell docking device, you can run the computer on AC power by connecting the AC adapter to the docking device.

 **NOTE:** If you are running your computer on AC power with a battery installed, the AC adapter charges the battery (if needed) and then maintains the battery's charge.

NOTICE: To avoid overheating the AC adapter when powering the computer or charging the battery, use the AC adapter in a ventilated area, such as on a desktop or on the floor. Do not use the AC adapter in a poorly ventilated environment, such as inside a carrying case.

Connecting the AC Adapter



About the Batteries

- 1 A partially charged lithium-ion battery comes standard in the battery bay, and provides power when an electrical outlet is not available. Dell recommends that you charge your battery to full capacity before using it to power the computer. For information on conserving battery power, see "[Conserving Power](#)."
- 1 To increase battery life, install a second battery in the modular bay.

 **CAUTION:** Do not puncture, disassemble, or incinerate the computer's battery. The battery may present a fire or chemical burn hazard if mistreated. Do not expose the battery to temperatures above 60° Celsius (C) (140° Fahrenheit [F]). Keep the battery away from children. Handle damaged or leaking batteries with extreme care. If the battery is damaged, electrolyte may leak from the cells and cause personal injury.

- 1 With a single fully charged, 8-cell lithium-ion battery, you can expect about 2–4 hours of battery life; with two fully charged lithium-ion batteries, 4–8 hours of battery life. Actual performance depends on the power management features and application programs you use.
- 1 When two batteries are installed, the computer draws power from the battery with the higher capacity until both batteries are at the same charge level. Then it draws power from both. The AC adapter first charges the battery in the battery bay.
- 1 The [integrated charge gauge](#) lets you check a battery's charge before you insert it into the computer.

- 1 The battery's self-test capability alerts you to battery conditions such as low charge.
- 1 The battery has a life span of around 400 discharge/charge cycles, provided it is charged at normal room temperature.
- 1 When you activate standby mode, the computer can run on a fully-charged battery for approximately one week.
- 1 If you are going to store the computer, disconnect all devices and turn off the computer. Remove the battery when you store your computer for an extended period of time. A battery will drain when not in use during prolonged storage. After a long storage period, recharge the battery fully before you attempt to run your computer from the battery.
- 1 Do not dispose lithium ion batteries with common household waste products. See "[Battery Disposal](#)" for more information.
- 1 Lithium-ion batteries are longer lived than conventional batteries and do not require replacement as often. You can charge the lithium ion battery whenever you like without fear of reducing its charge capacity. You do not need to drain a lithium ion battery completely before recharging it.

Removing a Battery

NOTICE: If you choose to replace the battery with the computer in standby mode, you have up to 4 minutes to complete the battery replacement. After 4 minutes, the computer shuts down and you will lose any unsaved data.

1. Ensure that the computer is turned off, suspended in a power management mode, or connected to an electrical outlet.
2. If the computer is docked, undock it.
3. Close the display and turn the computer over.
4. Slide and hold the battery bay (or module bay) latch release on the bottom of the computer, and then remove the battery from the bay.



Installing a Battery

Slide the battery into the bay until the latch release clicks.

Checking the Battery Charge

Press the battery test button next to the lights. The number of lights that appear shows an estimate of the remaining battery charge.

Battery Charge Gauge and Test Button



| Lights | Charge Remaining (%) or Description |
|--------|-------------------------------------|
|--------|-------------------------------------|

| | |
|----------------|---|
| 5 | 81–100 |
| 4 | 61–80 |
| 3 | 41–60 |
| 2 | 21–40 |
| 1 | 1–20; recharge the battery before using it |
| 0 | Completely drained or permanent failure ¹ |
| Rapid blinking | Temporary or recoverable failure such as overheating ² |

¹If you install a failed battery, the  light flashes amber rapidly. To purchase a new battery, [call Dell](http://www.dell.com) or go to the Dell website at <http://www.dell.com>. [Dispose](#) of the old battery properly.

²Allow a hot battery to cool for several minutes before checking the charge level again.





Battery Warnings

NOTICE: When you see a low-battery warning, save your work immediately. Then replace the battery or connect your computer to an electrical outlet.

NOTICE: To avoid losing data (and possibly corrupting data areas on your hard-disk drive), save your work immediately after a second low-battery warning. Then connect your computer to an electrical outlet, or place the computer in standby mode. If the battery runs completely out of power, the computer shuts off without properly closing any open files.

| Warning (If AC adapter is not attached) |  Light | Remaining Battery Life | Computer Response |
|---|---|------------------------|--|
| First low-battery | Blinking amber | About 15 minutes | If no further activity occurs, enters hibernate mode and turns off computer. If the computer has no hibernate file, enters standby mode. |
| Second low-battery | Steady amber | About 5 minutes | If no further activity occurs, enters hibernate mode. If there is no hibernate file, enters standby mode. If already in standby mode when second low-battery warning occurs, enters hibernate mode immediately. If hibernate mode has been disabled, reenters standby mode. |

Charging the Battery

- Each time you connect the computer to an electrical outlet or install a battery in a computer that is connected to an electrical outlet, the computer checks the battery's charge. If needed, the computer uses Dell ExpressCharge™ technology to charge the battery.
- If the computer is off and connected to an electrical outlet, ExpressCharge technology charges a fully discharged battery in about one hour. Otherwise, charge times depend on which devices you are using and which programs you are running.
- The  light remains steady green during charging.
- The  light starts blinking when the charge cycle is complete. While the  light is blinking, the AC adapter provides a trickle charge to bring the battery to full capacity. The  light continues to blink until you remove the battery or disconnect the computer from its electrical outlet.
- If two batteries are installed in the computer, the AC adapter first charges the battery in the battery bay, then the battery in the modular bay.

NOTICE: If the battery is hot from being used in your computer or being in a hot environment, follow these precautions:

- A hot battery will not charge when you connect the AC adapter to the computer. This feature is important because charging a hot battery shortens the battery's life span and may damage the battery and the computer.
- The battery is too hot to start charging if the  light flashes alternately green and amber. If this occurs while the computer is connected to an electrical outlet, disconnect the computer from the outlet and allow the computer and the battery to return to room temperature. Then reconnect the computer to its electrical outlet and continue charging the battery.
- If the computer is not allowed to return to room temperature, the battery stops charging before it reaches full capacity.

 **NOTE:** You can leave the battery in the computer as long as you like. The battery's integrated circuitry prevents the battery from overcharging.

Detecting Battery Problems

To avoid installing a defective battery in your computer, check the battery's charge by pressing the [battery test button](#). The battery gauge light will not light if the battery is completely drained. A battery problem may prevent the battery from being charged to its full potential and can lead to unpredictable operation.

|  Light After Installing a Battery | Problem | Action |
|--|---------------------------|---|
| Alternately green and amber | Battery too hot to charge | Turn off the computer, and let the battery and computer cool to room temperature. |
| Amber for 4 seconds after: <ul style="list-style-type: none">1 connecting or disconnecting AC adapter or <ul style="list-style-type: none">1 pressing the power button | Defective battery | Replace the battery. Call Dell or go to the Dell website at http://www.dell.com . |
| Rapidly amber | Defective battery | Replace the battery. Call Dell or go to the Dell website at http://www.dell.com |

Battery Disposal

When your battery no longer holds a charge, call your local waste disposal agency or environmental agency for advice on disposing of it. To purchase a new battery, [call Dell](#) or go to the Dell website at <http://www.dell.com>.



CAUTION: If your battery is damaged, or if it no longer holds a charge, dispose of it promptly and properly. Do not dispose of it along with household waste. Call your local waste disposal agency or environmental agency for advice on disposing of the battery.

[Back to Contents Page](#)

[Back to Contents Page](#)

Connecting Devices: Dell Precision™ Mobile Workstation M40 User's Guide

- [Back View](#)
 - [Left Side View](#)
 - [Right Side View](#)
 - [External Monitor](#)
 - [Parallel Devices](#)
 - [Docking Devices](#)
 - [USB Devices](#)
 - [Mouse, External Keyboard, and External Numeric Keypad](#)
 - [Serial Devices](#)
 - [AC Adapter](#)
 - [Infrared Sensor](#)
 - [Modem](#)
 - [Network](#)
 - [TV and Digital Audio](#)
 - [Audio Devices](#)
 - [IEEE 1394 Devices](#)
-

Back View

NOTICE: When disconnecting external devices from the back of the computer, wait 5 seconds after turning off the computer before you disconnect a device to avoid possible damage to the system board.

NOTICE: To avoid overheating the computer, do not place any objects close to an air intake or fan, and do not allow any objects to cover up an intake or fan.

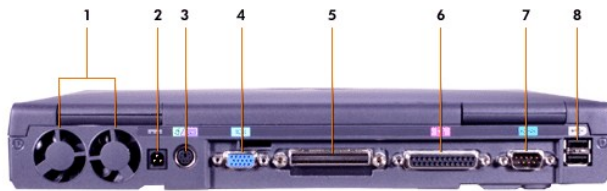

- | | |
|---|--------------------------------------|
| 1 Fans | 5 Docking connector |
| 2 AC power connector | 6 Parallel connector |
| 3 PS/2 connector (for mouse, keyboard, or keypad) | 7 Serial connector |
| 4 Video connector | 8 USB connectors |
-

Left Side View



- 1 Fixed optical drive pull-tab
- 2 Fixed optical drive
- 3 [S-video TV-out connector](#)

- 4 Security cable slot
- 5 Speaker

Right Side View

NOTICE: To avoid overheating the computer, do not place any objects close to an air intake or fan, and do not allow any objects to cover up an intake or fan.

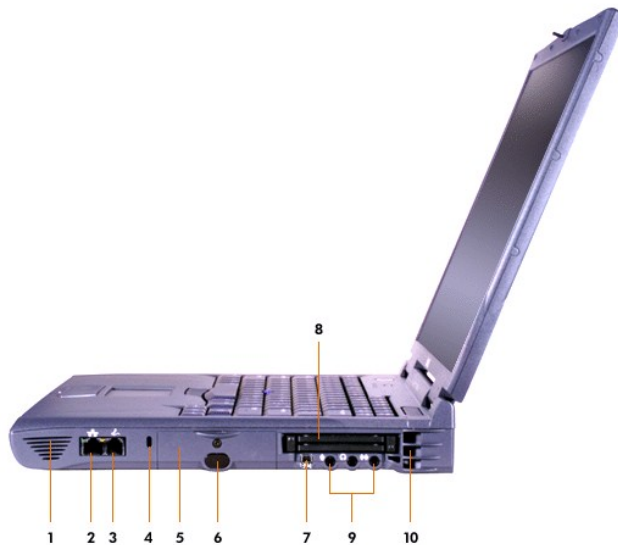

- 1 Speaker
- 2 [Network connector](#)
- 3 [Modem connector](#)
- 4 Security cable slot
- 5 Hard drive bay

- 6 [IR sensor](#)
- 7 [IEEE 1394 connector](#)
- 8 PC Card slots
- 9 [Audio connectors](#)
- 10 Air intake

External Monitor



You can attach an external monitor to the video connector.

NOTICE: Do not place the monitor directly on top of your mobile workstation computer, even if it is closed. Doing so can crack the computer case and the display.



1. Make sure that the external monitor is turned off. Set the monitor on a monitor stand, desktop, or other level surface near your computer.
2. Connect the external monitor's video cable to the computer.

Be sure to tighten all the screws on the video cable connector(s) to eliminate radio frequency interference (RFI).

3. Connect your external monitor to a grounded electrical outlet. If the monitor's power cable is not permanently attached to the monitor, connect it to the monitor.

Using an External Monitor

When an external monitor is connected to the computer, the video image appears on the external monitor's screen when you boot your computer.

Press   to switch the video image to the next display in the following sequence: the computer's display, the display and external monitor simultaneously, or an external monitor. Press <Scroll Lock><F8> on an external keyboard if the **External Hot Key** option is enabled in the [system setup program](#).

If the external monitor is turned off when you boot your computer, the computer still sends the video image to the external monitor, but you will not see an image on either the computer's display or the external monitor. To see an image, turn on the external monitor or switch the video image to the computer's display.



NOTE: If you are using your external monitor at a resolution greater than the display supports, the simultaneous display feature is disabled.

Parallel Devices



You can attach a parallel device (usually a printer) to the parallel connector.

Docking Devices



You can attach a Dell docking device to the docking connector. For information on docking your computer, see the documentation that came with your docking device.

USB Devices



You can attach USB-compatible devices such as a mouse, keyboard, printer, or scanner to a USB connector.

Mouse, External Keyboard, and External Numeric Keypad

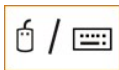

You can attach a mouse, 101- or 102-key keyboard, or numeric keypad to the Personal System/2 (PS/2) connector.

Mouse

If the **Pointing Device** option in the [system setup program](#) is set to **Touch Pad-PS/2 Mouse** (the default), you can use both the DualPoint device and an external PS/2-compatible mouse if one is attached. If you disconnect the mouse, to use the advanced features of the DualPoint device, you must shut down the computer or enter standby mode and then resume. If you do not do this, the DualPoint device resumes operation in standard PS/2 mode, which means that many of the configuration features are disabled.

If you are using a PS/2-compatible mouse that is not made by Microsoft and the mouse does not work properly, reboot the computer. If the mouse still does not work, install the drivers from the floppy disk or CD that came with the mouse and reboot the computer.

External Keyboard

You can use the computer's keyboard and an external keyboard at the same time. When you attach a keyboard to the computer, the embedded numeric keypad is automatically disabled.

On an external keyboard, the <Scroll Lock> key acts the same way as the <Fn> key on the computer's keyboard (if the **External Hot Key** option is enabled in the [system setup program](#)).

External Numeric Keypad

When you attach an external numeric keypad to the computer, the numeric keypad on the computer keyboard is automatically disabled. The lights on the integrated keyboard track the operation of an external numeric keypad.

Serial Devices



You can attach a serial device, such as a serial mouse, to the serial connector.

AC Adapter



You can attach the [AC adapter](#) to the AC adapter connector. The AC adapter converts AC power to the DC power required by the computer.

You can connect the AC adapter with your computer turned either on or off.

The AC adapter works with electrical outlets worldwide. However, power connectors vary among countries. Before using AC power in a foreign country, you may need to obtain a new power cable designed for use in that country.

Infrared Sensor



The computer's infrared (IR) sensor lets you transfer files from your computer to another IR-compatible device without using cable connections. When you receive your computer, the IR sensor is disabled. You can [enable the IR sensor](#) using the system setup program.

To transfer files after you enable the IR sensor:

1. Point the computer's IR sensor directly at the compatible device's IR sensor. IR devices transmit data in a 30-degree cone of IR light up to a distance of 1 meter (m) (3.3 feet [ft]).
2. Start the data communications software on both devices, and then begin to transfer files. Read the documentation that came with your compatible device to make sure that you operate the device correctly.

 **NOTE:** Make sure that books, papers, or other objects do not come between the two IR devices and that the two devices are aligned and within the 30-degree cone.

Using the IR Sensor

- 1 The IR sensor is compatible with Infrared Data Association (IrDA) 1.1 (Fast IR) and 1.0 (Slow IR) standards.
 - 1 The default address of the IR port is COM3. If the address causes resource conflicts with other devices, remap the address of the IR sensor.
 - 1 When the computer is connected to a Dell docking device, the IR sensor on the computer is automatically disabled.
 - 1 For more information about using an IR device, see the documentation that came with your operating system.
-

Modem



Plug in the telephone line to the modem connector.

NOTICE: Do not confuse the modem and network connectors on your computer. Do *not* plug a telephone line into the network connector.

For information on using the modem, see the online modem documentation supplied with your computer. To access the documentation, double-click the **Dell Documents** icon on the Windows desktop, click **System Information**, and then click **Communications**.

Network



For the internal network adapter, plug in the network line to the network connector.

NOTICE: Do not confuse the modem and network connectors on your computer. Do *not* plug a telephone line into the network connector.

For information on using the network adapter, see the online network adapter documentation supplied with your computer. To access the documentation, double-click the **Dell Documents** icon on the Windows desktop, click **System Information**, and then click **Communications**.

TV and Digital Audio



If your TV has an S-video cable, you can plug it directly into the S-video TV-out connector.

If your TV has a composite cable, use the TV/digital audio adapter cable that came with your computer to connect your TV to the computer. Make sure you attach the composite video cable to the composite connector of the TV/digital audio adapter cable. See the user manual that came with your television for instructions on connecting a composite cable or an S-video device.



- 1 Digital audio connector
- 2 Composite video connector
- 3 S-video connector

After you connect the television to the computer, you must also enable the television in your display settings.



NOTE: If you connect a television to your computer, you might need to change the display resolution to 800 x 600 pixels. See [Adjusting the Picture](#) for instructions.

Changing NVIDIA Video Card Display Settings

If your computer has an NVIDIA video card installed, follow these steps to enable the television in your display settings:

In Windows 2000:

1. Open the **Control Panel** window, double-click the **Display** icon, click the **Settings** tab, and then click the **Advanced** button.
2. Click the **TwinView** tab.
3. Click the **Output Device** button, and then click **Select Output Device....**
4. On the **Output Device** tab, click **TV** to select it.
5. Click **Apply**, and then click **OK**.

Connecting S/PDIF Devices

To connect a digital audio device with a S/PDIF connector, attach the S/PDIF cable to the digital audio connector on the TV/digital audio adapter cable. See the user manual that came with your S/PDIF device for instructions.

If you want to use a S/PDIF device and TV simultaneously:

1. Connect the S/PDIF cable to the digital audio connector on the TV/digital audio adapter cable.
2. Connect the S-video or composite cable to the S-video or composite connector on the TV/digital audio adapter cable.
3. Connect the TV/digital audio adapter cable to the S-video TV-out connector on the computer.

Adjusting the Picture



If an error message notifies you that the current resolution and color depth are using too much memory and preventing DVD playback, adjust the display properties:

In Windows 2000:

1. Open the **Control Panel** window, and then double-click the **Display** icon.
2. In the **Display Properties** window, click the **Settings** tab.
3. Click and drag the bar in **Screen area** and change the setting to 800 by 600 pixels by moving the bar to the left or right.
4. Click the pull-down menu under **Colors**, and then click **High Color (16 bit)**.
5. Click **OK**.

Audio Devices



You can attach headphones or speakers to the  connector, a microphone to the  connector, and record/playback devices such as cassette players and CD players to the  connector.

You can control the sound on your computer through the volume icon on the Windows taskbar, the system setup program, and [key combinations](#).

IEEE 1394 Devices



You can attach devices that require high-speed transfer rates, such as video cameras, to the IEEE 1394 connector.

[Back to Contents Page](#)

[Back to Contents Page](#)

Contacting Dell: Dell Precision™ Mobile Workstation M40 User's Guide

[Overview](#)

[Europe Contact Numbers](#)

[International Dialing Codes](#)

[Asia and Other Regions Contact Numbers](#)

[Americas Contact Numbers](#)

Overview

When you need to contact Dell, use the telephone numbers, codes, and electronic addresses provided in the following sections. "[International Dialing Codes](#)" provides the various codes required to make long-distance and international calls. "[Americas Contact Numbers](#)," "[Europe Contact Numbers](#)," and "[Asia and Other Regions Contact Numbers](#)" provide local telephone numbers, area codes, toll-free numbers, and e-mail addresses, if applicable, for each department or service available in various countries around the world.

If you are making a direct-dialed call to a location outside of your local telephone service area, determine which codes to use (if any) in "[International Dialing Codes](#)," in addition to the local numbers provided in the other sections.

For example, to place an international call from Paris, France to Bracknell, England, dial the international access code for France followed by the country code for the U.K., the city code for Bracknell, and then the local number as shown in the following illustration:

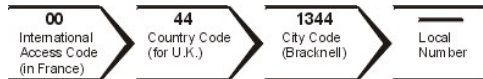

To place a long-distance call within your own country, use area codes instead of international access codes, country codes, and city codes. For example, to call Paris, France from Montpellier, France, dial the area code plus the local number as shown in the following illustration:



The codes required depend on where you are calling from as well as the destination of your call; in addition, each country has a different dialing protocol. If you need assistance in determining which codes to use, contact a local or an international operator.

 **NOTES:** Toll-free numbers are for use only within the country for which they are listed. Area codes are most often used to call long distance within your own country (not internationally)—in other words, when your call originates in the same country you are calling.

Have your Express Service Code ready when you call. The code helps Dell's automated-support telephone system direct your call more efficiently.

International Dialing Codes

Click a listed country to obtain the appropriate contact numbers.

| Country (City) | International Access Code | Country Code | City Code |
|--|---------------------------|--------------|--------------|
| Australia (Sydney) | 0011 | 61 | 2 |
| Austria (Vienna) | 900 | 43 | 1 |
| Belgium (Brussels) | 00 | 32 | 2 |
| Brazil | 0021 | 55 | 51 |
| Brunei | — | 673 | — |
| Canada (North York, Ontario) | 011 | — | Not required |
| Chile (Santiago) | — | 56 | 2 |
| China (Xiamen) | — | 86 | 592 |
| Czech Republic (Prague) | 00 | 420 | 2 |
| Denmark (Horsholm) | 00 | 45 | Not required |
| Finland (Helsinki) | 990 | 358 | 9 |
| France (Paris) (Montpellier) | 00 | 33 | (1) (4) |

| | | | |
|---|--------|-----|--------------|
| Germany (Langen) | 00 | 49 | 6103 |
| Hong Kong | 001 | 852 | Not required |
| Ireland (Cherrywood) | 16 | 353 | 1 |
| Italy (Milan) | 00 | 39 | 02 |
| Japan (Kawasaki) | 001 | 81 | 44 |
| Korea (Seoul) | 001 | 82 | 2 |
| Luxembourg | 00 | 352 | — |
| Macau | — | 853 | Not required |
| Malaysia (Penang) | 00 | 60 | 4 |
| Mexico (Colonia Granada) | 00 | 52 | Not required |
| Netherlands (Amsterdam) | 00 | 31 | 20 |
| New Zealand | 00 | 64 | — |
| Norway (Lysaker) | 00 | 47 | Not required |
| Poland (Warsaw) | 011 | 48 | 22 |
| Portugal | 00 | 35 | — |
| Singapore (Singapore) | 005 | 65 | Not required |
| South Africa (Johannesburg) | 09/091 | 27 | 11 |
| Spain (Madrid) | 00 | 34 | 91 |
| Sweden (Upplands Vasby) | 00 | 46 | 8 |
| Switzerland (Geneva) | 00 | 41 | 22 |
| Taiwan | 002 | 886 | — |
| Thailand | 001 | 66 | — |
| U.K. (Bracknell) | 010 | 44 | 1344 |
| U.S.A. (Austin, Texas) | 011 | 1 | Not required |

Americas Contact Numbers

| Country (City) | Department Name or Service | Area Code | Local Number or Toll-Free Number |
|--|---|-----------|----------------------------------|
| Antigua and Barbuda | General Support | | 1-800-805-5924 |
| Barbados | General Support | | 1-800-534-3066 |
| Bermuda | General Support | | 1-800-342-0671 |
| Brazil | Customer Support, Technical Support | | toll free: 0800 90 3355 |
| | Technical Support Fax | 51 | 51 481-5470 |
| | Sales | | toll free: 0800 90 3366 |
| | Web site: http://www.dell.com/br | | |
| Canada (North York, Ontario) | Automated Order-Status System | | toll free: 1-800-433-9014 |
| | AutoTech (Automated technical support) | | toll free: 1-800-247-9362 |
| | Customer Care (From outside Toronto) | | toll free: 1-800-387-5759 |
| | Customer Care (From within Toronto) | 416 | 758-2400 |

| | | | |
|--|--|-----|--------------------------------------|
| | Customer Technical Support | | toll free: 1-800-847-4096 |
| | Sales (Direct Sales—from outside Toronto) | | toll free: 1-800-387-5752 |
| | Sales (Direct Sales—from within Toronto) | 416 | 758-2200 |
| | Sales (Federal government, education, and medical) | | toll free: 1-800-567-7542 |
| | Sales (Major Accounts) | | toll free: 1-800-387-5755 |
| | TechFax | | toll free: 1-800-950-1329 |
| Cayman Islands | General Support | | 1-800-805-7541 |
| Chile (Santiago) <i>NOTE: Customers in Chile call the U.S.A. for sales, customer, and technical assistance</i> | Sales, Customer Support, and Technical Support | | toll free: 1230-020-4823 |
| Columbia | General Support | | 980-9-15-3978 |
| Costa Rica | General Support | | 800-012-0435 |
| Dominican Republic | General Support | | 1-800-148-0530 |
| El Salvador | General Support | | 01-889-753-0777 |
| Guatemala | General Support | | 1-800-999-0136 |
| Jamaica | General Support | | 1-800-682-3639 |
| Latin America <i>NOTE: Customers in Latin America call the U.S.A. for sales, customer, and technical assistance.</i> | Customer Technical Support (Austin, Texas, U.S.A.) | 512 | 728-4093 |
| | Customer Service (Austin, Texas, U.S.A.) | 512 | 728-3619 |
| | Fax (Technical Support and Customer Service) (Austin, Texas, U.S.A.) | 512 | 728-3883 |
| | Sales (Austin, Texas, U.S.A.) | 512 | 728-4397 |
| | SalesFax (Austin, Texas, U.S.A.) | 512 | 728-4600 728-3772 |
| Mexico | Customer Technical Support | | 001-877-384-8979 or 001-877-269-3383 |
| | Sales | | 50-81-8800 or 01-800-888-3355 |
| | Customer Service | | 001-877-384-8979 or 001-877-269-3383 |

| | | | |
|----------------------------------|---|---------------------------|--|
| | Main | | 50-81-8800 or 01-800-888-3355 |
| Netherlands Antilles | General Support | | 001-800-882-15194 |
| Nicaragua | General Support | | 001-800-220-1006 |
| Panama | General Support | | 001-800-507-0962 |
| Peru | General Support | | 0800-50-669 |
| Puerto Rico | General Support | | 800-805-7545 |
| St. Lucia | General Support | | 1-800-882-1521 |
| Trinidad and Tobago | General Support | | 1-800-805-8035 |
| U.S.A. (Austin, Texas) | Automated Order-Status System | | toll free: 1-800-433-9014 |
| | AutoTech (for portable and desktop computers) | | toll free: 1-800-247-9362 |
| | Dell Home and Small Business Group (for Inspiron™ and Latitude™ portable computers and Dimension™, Dell Precision™, and OptiPlex™ desktop computers): | | |
| | Customer Technical Support (Return Material Authorization Numbers) | | toll free: 1-800-624-9896 |
| | Customer Technical Support (Home sales purchased via http://www.dell.com) | | toll free: 1-877-576-3355 |
| | Customer Service (Credit Return Authorization Numbers) | | toll free: 1-800-624-9897 |
| | National Accounts (Precision Mobile Workstation M40 computers and systems purchased by established Dell national accounts [have your account number handy], medical institutions, or value-added resellers [VARs]) | | |
| | Customer Service and Technical Support (Return Material Authorization Numbers) | | toll free: 1-800-822-8965 |
| | Public Americas International (systems purchased by governmental agencies [local, state, or federal] or educational institutions): | | |
| | Customer Service and Technical Support (Return Material Authorization Numbers) | | toll free: 1-800-234-1490 |
| | Dell Sales | | toll free: 1-800-289-3355 toll free: 1-800-879-3355 |
| Spare Parts Sales | | toll free: 1-800-357-3355 | |
| DellWare™ | | toll free: 1-800-753-7201 | |

| | | | |
|----------------------------|---|-----|--|
| | Desktop and Portable Fee-Based Technical Support | | toll free: 1-800-433-9005 |
| | Sales (Catalogs) | | toll free: 1-800-426-5150 |
| | Fax | | toll free: 1-800-727-8320 |
| | TechFax | | toll free: 1-800-950-1329 |
| | Dell Services for the Deaf, Hard-of-Hearing, or Speech-Impaired | | toll free: 1-877-DELLTTY (1-877-335-5889) |
| | Switchboard | 512 | 338-4400 |
| | DellNet™ | | 1-877-dellnet (1-877-335-5638) |
| U.S. Virgin Islands | General Support | | 1-877-673-3355 |
| Venezuela | General Support | | 8001-3605 |

Europe Contact Numbers

| Country (City) | Department Name or Service | Area Code | Local Number or Toll-Free Number |
|---|--|-----------|----------------------------------|
| Austria (Vienna) <i>NOTE: Customers in Austria call Langen, Germany for Technical Support and Customer Care.</i> | Switchboard | 01 | 491 040 |
| | Home/Small Business Sales | 01 | 795676-02 |
| | Home/Small Business Sales Fax | 01 | 795676-05 |
| | Home/Small Business Customer Care | 01 | 795676-03 |
| | Preferred Accounts/Corporate Customer Care | | 0660-8056 |
| | Home/Small Business Technical Support | 01 | 795676-04 |
| | Preferred Accounts/Corporate Technical Support | | 0660-8779 |
| | Website: http://support.euro.dell.com | | |
| | E-mail: tech_support_central_europe@dell.com | | |
| Belgium (Brussels) | Technical Support | 02 | 481 92 88 |
| | Customer Care | 02 | 481 91 19 |
| | Home/Small Business Sales | | toll free: 0800 16884 |
| | Corporate Sales | 02 | 481 91 00 |
| | Fax | 02 | 481 92 99 |
| | Switchboard | 02 | 481 91 00 |
| | Website: http://support.euro.dell.com | | |
| | E-mail: tech_be@dell.com | | |
| | E-mail for French Speaking Customers: http://support.euro.dell.com/be/fr/emaildell/ | | |
| Czech Republic (Prague) | Technical Support | 02 | 22 83 27 27 |
| | Customer Care | 02 | 22 83 27 11 |
| | Fax | 02 | 22 83 27 14 |
| | TechFax | 02 | 22 83 27 28 |
| | Switchboard | 02 | 22 83 27 11 |
| | Website: http://support.euro.dell.com | | |
| | E-mail: czech_dell@dell.com | | |
| Denmark (Horsholm) | Technical Support | | 45170182 |
| | Relational Customer Care | | 45170184 |

| | | | | |
|--|---|-----------------------------------|-------------|---------------|
| <i>NOTE: Customers in Denmark call Sweden for fax technical support.</i> | Home/Small Business Customer Care | | 32875505 | |
| | Switchboard | | 45170100 | |
| | Fax Technical Support (Upplands Vasby, Sweden) | 46 | 859005594 | |
| | Fax Switchboard | | 45170117 | |
| | Website: http://support.euro.dell.com | | | |
| | E-mail: den_support@dell.com | | | |
| | E-mail Support for Servers: Nordic_server_support@dell.com | | | |
| Finland (Helsinki) | Technical Support | 09 | 253 313 60 | |
| | Technical Support Fax | 09 | 253 313 81 | |
| | Relational Customer Care | 09 | 253 313 38 | |
| | Home/Small Business Customer Care | 09 | 693 791 94 | |
| | Fax | 09 | 253 313 99 | |
| | Switchboard | 09 | 253 313 00 | |
| | Website: http://support.euro.dell.com | | | |
| | E-mail: fin_support@dell.com | | | |
| France (Paris/Montpellier) | Home and Small Business | | | |
| | Technical Support | 0825 | 387 270 | |
| | Customer Care | 0825 | 823 833 | |
| | Fax | 0825 | 004 701 | |
| | Fax (Alternative) | 04 | 99 75 40 01 | |
| | Switchboard | 0825 | 004 700 | |
| | Switchboard (Alternative) | 04 | 99 75 40 00 | |
| | Sales | 0825 | 004 700 | |
| | Website: http://support.euro.dell.com | | | |
| | E-mail: http://support.euro.dell.com/fr/fr/emaildell/ | | | |
| | Corporate | | | |
| | Technical Support | 0825 | 004 719 | |
| | Customer Care | 0825 | 338 339 | |
| | Fax | 01 | 55 94 71 01 | |
| | Switchboard | 01 | 55 94 71 00 | |
| | Sales | 01 | 55 94 71 00 | |
| | Website: http://support.euro.dell.com | | | |
| | E-mail: http://support.euro.dell.com/fr/fr/emaildell/ | | | |
| | Germany (Langen) | Technical Support | 06103 | 766-7200 |
| | | Home/Small Business Customer Care | | 0180-5-224400 |
| Global Segment Customer Care | | 06103 | 766-9570 | |
| Preferred Accounts Customer Care | | 06103 | 766-9420 | |
| Large Accounts Customer Care | | 06103 | 766-9560 | |
| Public Accounts Customer Care | | 06103 | 766-9555 | |
| Switchboard | | 06103 | 766-7000 | |
| Website: http://support.euro.dell.com | | | | |
| E-mail: tech_support_central_europe@dell.com | | | | |
| Ireland (Cherrywood) | | Technical Support | | 1850 543 543 |
| | Home User Customer Care | 01 | 204 4095 | |
| | Small Business Customer Care | 01 | 204 4026 | |
| | Corporate Customer Care | 01 | 279 5011 | |

| | | | |
|---|---|-----|----------------------|
| | Sales | 01 | 204 4444 |
| | SalesFax | 01 | 204 0144 |
| | Fax | | 204 5960 |
| | Switchboard | 01 | 204 4444 |
| | Website: http://support.euro.dell.com | | |
| | E-mail: dell_direct_support@dell.com | | |
| Italy (Milan) | Home and Small Business | | |
| | Technical Support | 02 | 577 826 90 |
| | Customer Care | 02 | 696 821 14 |
| | Fax | 02 | 696 821 13 |
| | Switchboard | 02 | 696 821 11 |
| | Website: http://support.euro.dell.com | | |
| | E-mail: http://support.euro.dell.com/it/it/emaildell/ | | |
| | Corporate | | |
| | Technical Support | 02 | 577 826 90 |
| | Customer Care | 02 | 577 825 55 |
| | Fax | 02 | 575 035 30 |
| | Switchboard | 02 | 577 821 |
| | Website: http://support.euro.dell.com | | |
| | E-mail: http://support.euro.dell.com/it/it/emaildell/ | | |
| Luxembourg <i>NOTE: Customers in Luxembourg call Belgium for sales, customer, and technical assistance.</i> | Technical Support (Brussels, Belgium) | 02 | 481 92 88 |
| | Home/Small Business Sales (Brussels, Belgium) | | toll free: 080016884 |
| | Corporate Sales (Brussels, Belgium) | 02 | 481 91 00 |
| | Customer Care (Brussels, Belgium) | 02 | 481 91 19 |
| | Switchboard (Brussels, Belgium) | 02 | 481 91 00 |
| | Fax (Brussels, Belgium) | 02 | 481 92 99 |
| | Website: http://support.euro.dell.com | | |
| | E-mail: tech_be@dell.com | | |
| Netherlands (Amsterdam) | Technical Support | 020 | 581 8838 |
| | Customer Care | 020 | 581 8740 |
| | Home/Small Business Sales | | toll free: 0800-0663 |
| | Home/Small Business Sales Fax | 020 | 682 7171 |
| | Corporate Sales | 020 | 581 8818 |
| | Corporate Sales Fax | 020 | 686 8003 |
| | Fax | 020 | 686 8003 |
| | Switchboard | 020 | 581 8818 |
| | Website: http://support.euro.dell.com | | |
| | E-mail: tech_nl@dell.com | | |
| Norway (Lysaker) <i>NOTE: Customers in Norway call Sweden for fax technical support.</i> | Technical Support | | 671 16882 |
| | Relational Customer Care | | 671 17514 |
| | Home/Small Business Customer Care | | 231 62298 |
| | Switchboard | | 671 16800 |
| | Fax Technical Support (Upplands Vasby, Sweden) | 00 | 46 08 590 05 594 |
| | Fax Switchboard | | 671 16865 |
| | Website: http://support.euro.dell.com | | |
| E-mail: nor_support@dell.com | | | |
| E-mail Support for Servers: | | | |

| | | | |
|-----------------------------------|--|----|---|
| | Nordic_server_support@dell.com | | |
| Poland (Warsaw) | Customer Service Phone | 22 | 57 95 700 |
| | Customer Care | 22 | 57 95 999 |
| | Sales | 22 | 57 95 999 |
| | Switchboard | 22 | 57 95 999 |
| | Customer Service Fax | 22 | 57 95 806 |
| | Fax | 22 | 57 95 998 |
| | Website: http://support.euro.dell.com | | |
| | E-mail: pl_support@dell.com | | |
| Portugal | Technical Support | 35 | 800 834 077 |
| | Customer Care | | 800 300 415 or 800 834 075 |
| | Sales | | 800 300 410 or 800 300 411 or 800 300 412 or 351 214 220 710 |
| | Switchboard | 34 | 917 229 200 |
| | Fax | 35 | 121 424 01 12 |
| | E-mail: http://support.euro.dell.com/es/es/emaildell/ | | |
| | | | |
| Spain (Madrid) | Home and Small Business | | |
| | Technical Support | | 902 100 130 |
| | Customer Care | | 902 118 540 |
| | Sales | | 902 118 541 |
| | Fax | | 902 118 539 |
| | Website: http://support.euro.dell.com | | |
| | E-mail: http://support.euro.dell.com/es/es/emaildell/ | | |
| | Corporate | | |
| | Technical Support | | 902 100 130 |
| | Customer Care | | 902 118 546 |
| | Switchboard | 91 | 722 92 00 |
| | Fax | 91 | 722 95 83 |
| | Website: http://support.euro.dell.com | | |
| | E-mail: http://support.euro.dell.com/es/es/emaildell/ | | |
| | | | |
| Sweden (Upplands Vasby) | Technical Support | 08 | 590 05 199 |
| | Relational Customer Care | 08 | 590 05 642 |
| | Home/Small Business Customer Care | 08 | 587 70 527 |
| | Fax Technical Support | 08 | 590 05 594 |
| | Sales | 08 | 590 05 185 |
| | Website: http://support.euro.dell.com | | |
| | E-mail: swe_support@dell.com E-mail Support for Latitude and Inspiron: Swe-nbk_kats@dell.com E-mail Support for OptiPlex: Swe_kats@dell.com E-mail Support for Servers: Nordic_server_support@dell.com | | |
| Switzerland (Geneva) | Technical Support (Home and Small Business) | | 0844 811 411 |
| | Technical Support (Corporate) | | 0844 822 844 |
| | Customer Care (Home and Small Business) | | 0848 802 202 |
| | Customer Service (Corporate) | | 0848 821 721 |

| | | | |
|----------------------------|--|-------|-----------|
| | Switchboard | 022 | 799 01 01 |
| | Fax | 022 | 799 01 90 |
| | Website: http://support.euro.dell.com | | |
| | E-mail for French Speaking HSB and Corporate Customers: http://support.euro.dell.com/ch/fr/emaildell/ | | |
| U.K. (Bracknell) | Technical Support (Corporate/Preferred Accounts/PAD [1000+ employees]) | 0870 | 908 0500 |
| | Technical Support (Direct/PAD and General) | 0870 | 908 0800 |
| | Global Accounts Customer Care | 01344 | 723186 |
| | Corporate Customer Care | 01344 | 72 3185 |
| | Preferred Accounts (500-5000 employees) Customer Care | 01344 | 723 196 |
| | Central Government Customer Care | 01344 | 723 193 |
| | Local Government Customer Care | 01344 | 723 194 |
| | Home/Small Business Sales | 0870 | 907 4000 |
| | Home/Small Business Customer Care | 0870 | 906 0010 |
| | Corporate/Public Sector Sales | 01344 | 860 456 |
| | Website: http://support.euro.dell.com | | |
| | E-mail: dell_direct_support@dell.com | | |

Asia and Other Regions Contact Numbers

| Country (City) | Department Name or Service | Area Code | Local Number or Toll-Free Number |
|--|---|-------------------|----------------------------------|
| Australia (Sydney) | Home and Small Business | | 1-300-65-55-33 |
| | Government and Business | | toll free: 1-800-633-559 |
| | Preferred Accounts Division (PAD) | | toll free: 1-800-060-889 |
| | Customer Care | | toll free: 1-800-819-339 |
| | Corporate Sales | | toll free: 1-800-808-385 |
| | Transaction Sales | | toll free: 1-800-808-312 |
| | Fax | | toll free: 1-800-818-341 |
| Brunei <i>NOTE: Customers in Brunei call Malaysia for customer assistance.</i> | Customer Technical Support (Penang, Malaysia) | | 633 4966 |
| | Customer Service (Penang, Malaysia) | | 633 4949 |
| | Transaction Sales (Penang, Malaysia) | | 633 4955 |
| China (Xiamen) | Home and Small Business Technical Support | | toll free: 800 858 2437 |
| | Corporate Accounts Technical Support | | toll free: 800 858 2333 |
| | Customer Experience | | toll free: 800 858 2060 |
| | Home and Small Business | | toll free: 800 858 2222 |
| | Preferred Accounts Division | | toll free: 800 858 2062 |
| | Large Corporate Accounts North | | toll free: 800 858 2999 |
| | Large Corporate Accounts East | | toll free: 800 858 2020 |
| | Large Corporate Accounts South | | toll free: 800 858 2355 |
| | Large Corporate Accounts GCP | | toll free: 800 858 2055 |
| | Large Corporate Accounts HK | | toll free: 800 964108 |
| | Large Corporate Accounts GCP HK | | toll free: 800 907308 |
| | Hong Kong | Technical Support | |

| | | | |
|---|--|-------|--|
| <i>NOTE: Customers in Hong Kong call Malaysia for customer assistance.</i> | Customer Service (Penang, Malaysia) | | 633 4949 |
| | Transaction Sales | | toll free: 800 96 4109 |
| | Corporate Sales | | toll free: 800 96 4108 |
| Japan (Kawasaki) | Technical Support (Server) | | toll free: 0120-1984-35 |
| | Technical Support Outside of Japan (Server) | 81-44 | 556-4152 |
| | Technical Support (Dimension and Inspiron) | | toll free: 0120-1982-26 |
| | Technical Support Outside of Japan (Dimension and Inspiron) | 81-44 | 520-1435 |
| | Technical Support (Dell Precision, OptiPlex, and Latitude) | | toll free: 0120-1984-33 |
| | Technical Support Outside of Japan (Dell Precision, OptiPlex, and Latitude) | 81-44 | 556-3894 |
| | Customer Care | 044 | 556-4240 |
| | 24-Hour Automated Order Status Service | 044 | 556-3801 |
| | Individual User | 044 | 556-1657 |
| | Business Sales Division (up to 400 employees) | 044 | 556-3494 |
| | Public Sales (Government Agencies, Education Institutions, and Medical Institutions) | 044 | 556-3440 |
| | Preferred Accounts Division Sales (over 400 employees) | 044 | 556-3433 |
| | Global Segment Japan | 044 | 556-3469 |
| | Large Corporate Accounts Sales (over 3500 employees) | 044 | 556-3440 |
| | Faxbox Service | 044 | 556-3490 |
| | Switchboard | 044 | 556-4300 |
| | | | Web site: http://support.jp.dell.com |
| Korea (Seoul) | Technical Support | | toll free: 080-200-3800 |
| | Sales | | toll free: 080-200-3600 |
| | Customer Service (Penang, Malaysia) | | toll free: 604-633-4949 |
| | Customer Service (Seoul, Korea) | | 080-200-3800 |
| | Fax | | 2194-6202 |
| | Switchboard | | 2194-6000 |
| Macau <i>NOTE: Customers in Macau call Malaysia for customer assistance.</i> | Technical Support | | toll free: 0800 582 |
| | Customer Service (Penang, Malaysia) | | 633 4949 |
| | Transaction Sales | | toll free: 0800 581 |
| Malaysia (Penang) | Technical Support | | toll free: 1 800 888 298 |
| | Customer Service | 04 | 633 4949 |
| | Transaction Sales | | toll free: 1 800 888 202 |
| | Corporate Sales | | toll free: 1 800 888 213 |
| New Zealand | Home and Small Business | | 0800 446 255 |
| | Government and Business | | 0800 444 617 |
| | Sales | | 0800 441 567 |
| | Fax | | 0800 441 566 |
| Singapore (Singapore) <i>NOTE: Customers in Singapore call Malaysia for customer assistance.</i> | Technical Support | | toll free: 800 6011 051 |
| | Customer Service (Penang, Malaysia) | 04 | 633 4949 |
| | Transaction Sales | | toll free: 800 6011 054 |
| | Corporate Sales | | toll free: 800 6011 053 |
| South Africa | Technical Support | 011 | 709 7710 |

| | | | |
|---|--|-----|--|
| (Johannesburg) | Customer Care | 011 | 709 7707 |
| | Sales | 011 | 709 7700 |
| | Fax | 011 | 706 0495 |
| | Switchboard | 011 | 709 7700 |
| | Website: http://support.euro.dell.com | | |
| | E-mail: dell_za_support@dell.com | | |
| Southeast Asian/Pacific Countries (excluding Australia, Brunei, China, Hong Kong, Japan, Korea, Macau, Malaysia, New Zealand, Singapore, Taiwan, and Thailand—refer to individual listings for these countries) | Customer Technical Support, Customer Service, and Sales (Penang, Malaysia) | | 60 4 633-4810 |
| Taiwan | Technical Support | | toll free: 0080 60 1225 |
| | Technical Support (Servers) | | toll free: 0080 60 1256 |
| | Customer Service (Penang, Malaysia) | | 633 4949 |
| | Transaction Sales | | toll free: 0080 651 228/0800 33 556 |
| | Corporate Sales | | toll free: 0080 651 227/0800 33 555 |
| Thailand <i>NOTE: Customers in Thailand call Malaysia for customer assistance.</i> | Technical Support | | toll free: 088 006 007 |
| | Customer Service (Penang, Malaysia) | | 633 4949 |
| | Sales | | toll free: 088 006 009 |

[Back to Contents Page](#)

[Back to Contents Page](#)

Dell Diagnostics: Dell Precision™ Mobile Workstation M40 User's Guide

[When to Use the Dell Diagnostics](#)

[Advanced Testing](#)

[Features of the Dell Diagnostics](#)

[Confirming the System Configuration Information](#)

[Starting the Dell Diagnostics](#)

When to Use the Dell Diagnostics

Whenever a major component or device in your computer does not function properly, you may have a component failure. If you are experiencing a problem with your computer, Dell recommends that you perform the checks in "[Finding Solutions](#)" and run the Dell Diagnostics *before* you call Dell for technical assistance.

As long as the microprocessor and the input and output components of your computer (the display, keyboard, and floppy drive) are working, you can use the Dell Diagnostics. Running the Dell Diagnostics may help you to resolve the problem yourself quickly without having to contact Dell for assistance.

If you are experienced with computers and know what component(s) you need to test, simply select the appropriate diagnostic test group(s) or subtest(s). If you are unsure about how to begin diagnosing a problem, see "[Starting the Dell Diagnostics](#)" and "[Advanced Testing](#)."

Features of the Dell Diagnostics

The Dell Diagnostics helps you check your computer's hardware without any additional equipment and without destroying any data. By using the diagnostics, you can have confidence in your computer's operation. And if you find a problem you cannot solve by yourself, the diagnostic tests can provide you with important information you will need when talking to Dell's service and support personnel. If you are experiencing a problem with your computer, Dell recommends that you perform the checks in "[Finding Solutions](#)" and run the Dell Diagnostics *before* you call Dell for technical assistance.

NOTICE: Use the Dell Diagnostics to test only your Dell™ computer. Using this program with other computers may cause incorrect computer responses or result in error messages.

The diagnostic test groups or subtests also have these helpful features:

- 1 Options that let you perform quick checks or extensive tests on one or all devices
 - 1 An option that allows you to choose the number of times a test group or subtest is repeated
 - 1 The ability to display test results or to save them in a file
 - 1 Options to temporarily suspend testing if an error is detected, or to terminate testing when an adjustable error limit is reached
 - 1 Extensive online Help screens that describe the tests and how to run them
 - 1 Status messages that inform you whether test groups or subtests were completed successfully
 - 1 Error messages that appear if any problems are detected
-

Starting the Dell Diagnostics

 **NOTE:** Dell recommends that print these procedures before you begin.

1. Turn off the computer.
2. Undock the computer if you have it docked.
3. Turn on the computer.
4. Press <F2> at the start of the boot routine to access the system setup menu.

 **NOTE:** Write down your current boot sequence in the event you want to restore it after running the Dell Diagnostics.

5. Select the following boot sequence.

 **NOTE:** You can only boot from a CD, CD-RW, or DVD drive installed as a fixed optical drive. You cannot boot from one of these modules installed in the modular bay.

- 1 **Boot First Device: Diskette Drive**
- 1 **Boot Second Device: CD/DVD/CD-RW Drive**
- 1 **Boot Third Device: Internal HDD**

6. Insert the Dell *ResourceCD* into the CD drive.
7. Turn the computer off.
8. Turn the computer on. The computer starts and automatically begins to run the Dell Diagnostics.
9. When you have completed running diagnostics, remove the *ResourceCD* from the CD drive.

To change the boot sequence, repeat steps 1 through 6, customizing the boot sequence to fit your needs. Then restart your computer.

When you start the diagnostics, the Dell logo screen appears, followed by a message telling you that the diagnostics is loading. After the diagnostics loads, the **Diagnostics Menu** appears.

To select an option from this menu, highlight the option and press <Enter>, or press the key that corresponds to the highlighted letter in the option you choose.

Diagnostics Menu

| | Option | Function |
|---|-------------------------|---|
| Test All Devices Test One Device Advanced Testing Information and Results Program Options Exit to MS-DOS | Test All Devices | Performs extensive diagnostic tests or quick diagnostic tests on all devices. |
| | Test One Device | Performs extensive diagnostic tests or quick diagnostic tests on one device after you select it from a list of device groups. After you select Test One Device , press <F1> for more information about a test. |
| | Advanced Testing | Allows you to modify the parameters of a test and select a group of tests to perform. You can access online Help for more information about Advanced Testing . |
| | Information and Results | Provides test results, test errors, version numbers of the subtests used by the Dell Diagnostics, and additional help on the Dell Diagnostics. |
| | Program Options | Allows you to change the settings of the Dell Diagnostics. |
| | Exit to MS-DOS | Exits to the MS-DOS® prompt. |

For a quick check of your computer, select **Quick Tests** from the **Test All Devices** or **Test One Device** option. **Quick Tests** runs only the subtests that do not require user interaction and that do not take a long time to run. Dell recommends that you choose **Quick Tests** first to increase the odds of tracing the source of the problem quickly.

For a thorough check of your computer, select **Extended Tests** from the **Test All Devices** option.

To check a particular area of your computer, select **Extended Tests** from the **Test One Device** option, or select the **Advanced Testing** option to customize your test(s).

Advanced Testing

When you select **Advanced Testing** from the **Diagnostics Menu**, the following screen appears listing the diagnostic test device groups and devices of the selected device group, and it allows you to select categories from a menu. Press the arrow keys or <Page Up> and <Page Down> keys to navigate the screen.

Advanced Testing Main Screen

| Device Groups | Devices for Highlighted Group |
|--|-------------------------------|
| (Top) | |
| System Board Devices | DMA Controller |
| Processor Cache | Realtime Clock |
| IR | System Timer |
| System Memory | Interrupt Controller |
| Latitude Battery | System Speaker |
| Latitude Fan | Floating Point Unit |
| Latitude Temperature | |
| System Management BIOS | |
| VESA/VGA Interface | |
| Universal Serial Bus Interface | |
| PC-AT Compatible Keyboards | |
| Pointing Devices | |
| Serial Ports | |
| Parallel Ports | |
| Diskette | |
| (More) | |
| Device groups: Run tests Devices Select Config Help | |
| Display the Run tests menu. Press ESC for previous menu. | |

Information in the **Advanced Testing** screen is presented as follows:

1. On the left side of the screen, the **Device Groups** area lists the diagnostic test groups in the order they will run if you select **All** from the **Run tests** menu category. Press the up- or down-arrow key to highlight a test device group.
1. On the right side of the screen, the **Devices for Highlighted Group** area lists the computer's currently detected hardware and some of the relevant settings.
1. Two lines at the bottom of the screen make up the menu area (see "[Advanced Testing Help Menu](#)"). The first line lists the categories you can select; press the left- or right-arrow key to highlight a menu category. The second line gives information about the category currently highlighted.

 **NOTE:** The options displayed on your screen should reflect the hardware configuration of your computer.

Advanced Testing Help Menu

For more information on using the **Advanced Testing** option:

1. Press <h>.
2. Highlight the Help category and press <Enter>, or press the key that corresponds to the highlighted letter in the category you choose.

Advanced Testing Help Categories

| Help Category | Description |
|---------------|---|
| Menu | Provides descriptions of the main menu screen area, the Device Groups, and the different diagnostic menus and commands and instructions on how to use them. |
| Keys | Explains the functions of the all of the keystrokes that can be used in Dell Diagnostics. |
| Device Group | Describes the test group that is presently highlighted in the Device Groups list on the main menu screen. It also provides reasoning for using some tests. |
| Device | Describes the function and purpose of the highlighted device in the Device Groups . For example, the following information appears when you select the Device Help category for Diskette in the Device Groups list: <u>Diskette Drive A</u> The floppy drive device reads and writes data to and from floppy disks. Floppy disks are flexible recording media, sometimes contained in hard shells. Floppy disk recording capacities are small and access times are slow relative to hard disk drives, but they provide a convenient means of storing and transferring data. |
| Test | Provides a thorough explanation of the test procedure of each highlighted test group subtest. An example of the Diskette subtest floppy drive Seek Test is as follows: <u>Diskette Drive A - floppy drive Seek Test</u> This test verifies the drive's ability to position its read/write heads. The test operates in two passes: first, seeking from the beginning to ending cylinders |

| | |
|----------|--|
| | inclusively, and second, seeking alternately from the beginning to ending cylinders with convergence towards the middle. |
| Versions | Lists the version numbers of the subtests that are used by the Dell Diagnostics. |

Confirming the System Configuration Information

When you boot your computer from your *ResourceCD*, the diagnostics checks your system configuration information and displays it in the **Device Groups** area on the main screen.

The following sources supply this configuration information for the diagnostics:

- 1 The system configuration information settings (stored in nonvolatile random-access memory [NVRAM]) that you selected while using the system setup program
- 1 Identification tests of the microprocessor, the video controller, the keyboard controller, and other key components
- 1 Basic input/output system (BIOS) configuration information temporarily saved in RAM

Do not be concerned if the **Device Groups** area does not list the names of all the components or devices you know are part of your computer. For example, you may not see a printer listed, although you know one is attached to your computer. Instead, the printer is listed as a parallel port. The computer recognizes the parallel port as LPT1, which is an address that tells the computer where to send outgoing information and where to look for incoming information. Because your printer is a parallel communications device, the computer recognizes the printer by its LPT1 address and identifies it as a parallel port. You can test your printer connection in the **Parallel Ports** tests.

[Back to Contents Page](#)

[Back to Contents Page](#)

Reinstalling Software: Dell Precision™ Mobile Workstation M40 User's Guide

- [Installing Drivers and Utilities](#)
- [Reinstalling the Asset Tag Utility](#)
- [Manually Reinstalling the Internal Modem and Network Adapter Drivers \(Optional\)](#)

 **NOTES:** Dell recommends that you print these procedures before you begin.

You may need administrator privileges to perform some of the procedures in this section. Dell recommends that you check with your network administrator before performing the procedures.

Installing Drivers and Utilities

The Dell *Drivers and Utilities* CD for your computer contains most of the drivers that you will need for your computer, including drivers for operating systems that may not be on your computer. Verify that the driver you are loading is for your operating system.

To reinstall drivers for optional devices such as wireless communications, DVD drives, and Zip drives, see the software CD and documentation that came with those devices.

You can also access and download new drivers, system tools, and documentation from Dell's technical support page at support.dell.com. For more information on using the operating system installed on your computer by Dell, see the operating system user's guide that came with your computer.

NOTICE: Before you reinstall drivers, make sure that your computer is undocked.

To install a driver or utility from your *Drivers and Utilities* CD:

1. Save your work in all open programs.
2. Insert your *Drivers and Utilities* CD into the CD or DVD drive.

In most cases, the CD should start running automatically. If it does not, start Microsoft® Windows® Explorer, click your CD drive directory to display the CD contents, and then click the **autorcd** application file. If a welcome screen appears, click **Next**. The first time that you run the CD, it might prompt you to install some setup files. Click **OK** and follow the instructions on the screen to continue.

3. From the **Language** pull-down menu on the toolbar, select your preferred language for the driver or utility (if available).

A welcome screen appears.

4. Click **Next**.

5. Under **Search Criteria**, select the appropriate categories from the **System Model**, **Operating System**, **Device Type**, and **Topic** pull-down menus.

A link or links appear(s) for the specific drivers or utilities used by your computer.

6. Click the link of a specific driver or utility to display information about the driver or utility you want to install.

7. At the driver information screen, do one of the following:

- 1. Click the **Install** button (if present) to start the automatic installation. At the welcome screen, follow the screen prompts to complete the installation.
- 1. If no **Install** button is present, automatic installation is not an option. For installation instructions, either go to the appropriate procedure below or click **Extract**, follow the extracting instructions, and read the readme file.

 **NOTE:** If instructed to navigate to the driver files, click the CD directory on the driver information screen to display the files associated with that driver.

Reinstalling the Asset Tag Utility

1. Insert the *Drivers and Utilities* CD.

In most cases, the CD should start running automatically. If it does not, start Windows Explorer, click your CD drive directory to display the CD contents, and then double-click the **autorcd** application file. If a welcome screen appears, click **Next**. The first time that you run the CD, it might prompt you to install some setup files. Click **OK** and follow the instructions on the screen to continue.

2. Under **Search Criteria**, select the appropriate categories from the **System Model**, **Operating System**, and **Device Type** pull-down

menus, and select **Utilities** from the **Topic** pull-down menu.

A link or links appear(s) for the specific utilities used by your computer.

3. Click **Asset Tag**.
4. Click **Extract**.
5. Unzip the **Asset Tag** utility on the *Drivers and Utilities* CD to the **c:\dell\util** directory on your hard drive.

To use the utility, see "[Assigning an Asset Tag](#)."

Manually Reinstalling the Internal Modem and Network Adapter Drivers (Optional)

If you ordered the internal modem, you need to reinstall the modem driver.

If you ordered the combination modem/network adapter, you need to reinstall both the modem and network adapter drivers.

To install a modem or network adapter driver, use the appropriate procedure in this section, depending on your operating system.

Installing the Modem or Network Adapter Driver for Windows 2000

1. Save your work in all open programs, and insert your *Drivers and Utilities* CD.
2. Click the **Start** button, point to **Settings**, and double-click **Control Panel**.
3. In the **Control Panel** window, double-click the **System** icon.
4. In the **System Properties** window, click the **Hardware** tab.
5. Click **Device Manager....** Under **Other Devices**:

*If you are installing a modem driver, click **PCI Simple Communications Controller**.*

*If you are installing a network adapter, click **Ethernet Controller**.*

6. From the pull-down menu, click **Driver**, and select **Properties**.
 7. Click **Reinstall Driver**, and click **Next**.
 8. Verify that **Search for a suitable driver for my device (Recommended)** is selected, and click **Next**.
 9. Verify that **CD-ROM drives** is selected, and click **Next**.
 10. When the search is complete and the appropriate driver found, click **Next**.
 11. Click **Finish** to complete installation of the modem driver.
-

[Back to Contents Page](#)

[Back to Contents Page](#)

Understanding Error Messages: Dell Precision™ Mobile Workstation M40 User's Guide

Your application programs, operating system, and the computer itself can identify problems and alert you to them. When this occurs, a message may appear on the computer's display or on an external monitor (if one is attached), or a flash code may be emitted.

If an error message appears on the display or external monitor, make a note of the message. For an explanation of the message and suggestions for correcting any errors, see "[System Error Messages](#)." The messages are listed alphabetically.

 **NOTE:** If the message is not listed in "[System Error Messages](#)," see the documentation for the application program that was running at the time the message appeared and/or the operating system documentation for an explanation of the message and a recommended action.

System Error Messages

| Message | Cause | Action |
|-------------------------------------|---|--|
| Auxiliary device failure | The touch pad, track stick, or external PS/2 mouse may be faulty. | If you are using an external mouse only, check the connection for a loose or improperly connected cable. If the problem persists, enable the Pointing Device option. If the problem persists, call Dell for technical assistance. |
| Bad command or file name | The command you entered does not exist or is not in the pathname you specified. | Make sure that you have typed the command correctly, placed spaces in the proper location, and used the correct pathname. |
| Cache disabled due to failure | The primary cache internal to the microprocessor has failed. | Call Dell for technical assistance. |
| CD drive controller failure 1 | The CD drive does not respond to commands from the computer. | Turn off the computer, remove the drive, and boot the computer from a bootable floppy disk. Then turn off the computer again, reinstall the drive, and reboot the computer. If the problem persists, try another drive. Then run the CD drive tests in the Dell Diagnostics . |
| Data error | The floppy or hard drive cannot read the data. | Run the appropriate utility to check the file structure of the floppy drive or hard drive. See the documentation that came with your operating system. |
| Decreasing available memory | One or more memory modules may be faulty or improperly seated. | Reseat the memory modules and, if necessary, replace them. |
| Disk C: failed initialization | The hard drive failed initialization. | Run the hard drive tests in the Dell Diagnostics . |
| floppy drive 0 seek failure | A cable may be loose, or the system configuration information may not match the hardware configuration. | Run the floppy drive tests in the Dell Diagnostics . If error is not corrected, have the cables checked by an authorized service technician. |
| Diskette read failure | A cable may be loose, or the floppy disk may be faulty. | If the  access light lights up, try a different floppy disk. |
| Diskette subsystem reset failed | The floppy drive controller may be faulty. | Run the floppy drive tests in the Dell Diagnostics . |
| Diskette write-protected | Because the floppy disk is write-protected, the operation cannot be completed. | Slide the write-protect notch up. |
| Drive not ready | No floppy disk is in the floppy drive, or no hard drive is in the drive bay. The operation requires a floppy disk in the drive or a hard drive in the bay before it can continue. | Put a floppy disk in the drive, or push the floppy disk all the way into the drive until the eject button pops out. Or, install a hard drive in the drive bay. |
| Error reading PCMCIA card | The computer cannot identify the PC Card. | Reseat the card or try another PC Card that you know works. |
| Extended memory size has changed | The amount of memory recorded in NVRAM does not match the memory installed in the computer. | Reboot the computer. If the error appears on the display again, call Dell for technical assistance. |
| Gate A20 failure | An installed memory module may be loose. | Reseat the memory modules and, if necessary, replace them. |
| General failure | The operating system is unable to carry out the command. | This message is usually followed by specific information—for example, Printer out of paper . Respond by taking the appropriate action. |
| Hard-disk drive configuration error | The computer cannot identify the drive type. | Turn off the computer, remove the drive, and boot the computer from a bootable floppy disk. Then turn off the |

| | | |
|---|--|--|
| | | computer, reinstall the drive, and reboot the computer. Run the hard drive tests in the Dell Diagnostics . |
| Hard-disk drive controller failure 0 | The hard drive does not respond to commands from the computer. | Turn off the computer, remove the drive, and boot the computer from a bootable floppy disk. Then turn off the computer again, reinstall the drive, and reboot the computer. If the problem persists, try another drive. Then run the hard drive tests in the Dell Diagnostics . |
| Hard-disk drive failure | The hard drive does not respond to commands from the computer. | Turn off the computer, remove the drive, and boot the computer from a bootable floppy disk. Then turn off the computer again, reinstall the drive, and reboot the computer. If the problem persists, try another drive. Then run the hard drive tests in the Dell Diagnostics . |
| hard drive read failure | The hard drive may be faulty. | Turn off the computer, remove the drive, and boot the computer from a bootable floppy disk. Then turn off the computer again, reinstall the drive, and reboot the computer. If the problem persists, try another drive. Then run the hard drive tests in the Dell Diagnostics . |
| Invalid configuration information-please run System Setup Program | The system configuration information does not match the hardware configuration. This message is most likely to occur after a memory module is installed. | Correct the appropriate options in the system setup program. |
| Keyboard clock line failure | A cable or connector may be loose, or the keyboard may be faulty. | Run the Keyboard Controller test in the Dell Diagnostics . |
| Keyboard controller failure | A cable or connector may be loose, or the keyboard may be faulty. | Reboot the computer, and avoid touching the keyboard or the mouse during the boot routine. If the problem persists, run the Keyboard Controller test in the Dell Diagnostics . |
| Keyboard data line failure | A cable or connector may be loose, or the keyboard may be faulty. | Run the Keyboard Controller test in the Dell Diagnostics . |
| Keyboard stuck key failure | If an external keyboard or keypad is being used, a cable or connector may be loose or the keyboard may be faulty. If the integrated keyboard is being used, the keyboard may be faulty. A key on the integrated keyboard or external keyboard may have been pressed while the computer was booting. | Run the Stuck Key test in the Dell Diagnostics . |
| Memory address line failure at address, read value expecting value | An installed memory module may be faulty or improperly seated. | Reseat the memory modules and, if necessary, replace them. |
| Memory allocation error | The software you are attempting to run is conflicting with the operating system, another application program, or a utility. | Turn off the computer, wait 30 seconds, and then restart it. Try to run the program again. If the problem persists, contact the software company. |
| Memory data line failure at address, read value expecting value | An installed memory module may be faulty or improperly seated. | Reseat the memory modules and, if necessary, replace them. |
| Memory double word logic failure at address, read value expecting value | An installed memory module may be faulty or improperly seated. | Reseat the memory modules and, if necessary, replace them. |
| Memory odd/even logic failure at address, read value expecting value | An installed memory module may be faulty or improperly seated. | Reseat the memory modules and, if necessary, replace them. |
| Memory write/read failure at address, read value expecting value | An installed memory module may be faulty or improperly seated. | Reseat the memory modules and, if necessary, replace them. |
| No boot device available | The computer cannot find the floppy or hard drive. | If the floppy drive is your boot device, make sure that there is a bootable floppy disk in the drive. If the hard drive is your boot device, make sure that the drive is installed, properly seated, and partitioned as a boot device. |
| No boot sector on hard drive | The operating system may be corrupted. | Reinstall your operating system. See the documentation that came with your operating system. |
| No timer tick interrupt | A chip on the system board may be malfunctioning. | Run the System Set tests in the Dell Diagnostics . |
| Non-system disk or disk error | The floppy disk in drive A or your hard-disk drive does not have a bootable operating system installed on it. | If you are trying to boot from the floppy disk, replace it with one that has a bootable operating system. |

| | | |
|--|---|--|
| Not a boot diskette | There is no operating system on the floppy disk. | Boot the computer with a floppy disk that contains an operating system. |
| Optional ROM bad checksum | The optional ROM apparently failed. | Call Dell for technical assistance. |
| Sector not found | The operating system cannot locate a sector on the floppy or hard drive. You probably have a bad sector or corrupted FAT on the floppy or hard drive. | Run the appropriate utility to check the file structure on the floppy or hard drive. If a large number of sectors are defective, back up the data (if possible), and then reformat the floppy or hard drive. |
| Seek error | The operating system cannot find a specific track on the floppy or hard drive. | If the error is on the floppy drive, try another floppy disk in the drive. |
| Shutdown failure | A chip on the system board may be malfunctioning. | Run the System Set tests in the Dell Diagnostics . |
| Time-of-day clock lost power | Data stored in NVRAM has become corrupted. | Connect your computer to an electrical outlet to charge the battery. If the problem persists, try to restore the data. To restore the data, press <Fn><F1> to enter the system setup program . Then immediately exit it. If the message reappears, call Dell for technical assistance. |
| Time-of-day clock stopped | The reserve battery that supports the data stored in NVRAM may be read. | Connect your computer to an electrical outlet to charge the battery. If the problem persists, call Dell for technical assistance. |
| Time-of-day not set- please run the System Setup program | The time or date stored in the system setup program does not watch the system clock. | Correct the settings for the Date and Time options. (For instructions, see " Using the System Setup Program .") |
| Timer chip counter 2 failed | A chip on the system board may be malfunctioning. | Run the System Set tests in the Dell Diagnostics . |
| Unexpected interrupt in protected mode | The keyboard controller may be malfunctioning, or an installed memory module may be loose. | Run the System Memory tests and the Keyboard Controller test in the Dell Diagnostics . |
| Warning: Battery is critically low. | The battery is running out of charge. | Replace the battery , or connect the computer to an electrical outlet. Otherwise, activate hibernate mode or turn off the computer. |

[Back to Contents Page](#)

[Back to Contents Page](#)

Features and Options: Dell Precision™ Mobile Workstation M40 User's Guide

- 1 15.0-inch ultra extended graphics array (UXGA), TFT 1600 x 1200 active-matrix color display.
- 1 256-bit internal data path hardware accelerated video support, with 32 megabytes (MB) of video memory (standard) and 64-bit memory bus.
- 1 ESS Maestro 3i audio controller with software wavetable support and emulated 3D sound.
- 1 Accelerated graphics port (AGP) architecture that increases the computer's video performance.
- 1 Integrated all-in-one multimedia capability:
 - o Fixed optical drive that supports a DVD/CD-RW combination drive.
 - o Modular bay that supports modules such as a second battery, DVD/CD-RW combination drive, CD-RW drive, and floppy drives.
- 1 10/100 LAN + 56K V.90 Mini PCI data/fax modem, PC99-compliant, with ACPI power management support (including remote wake-up for Microsoft® Windows® 2000).

For additional information on the Mini PCI modem, see "[Connecting Devices](#)" and the 10/100 LAN + V.90 Modem Mini PCI modem *User's Guide*.

- 1 Dell AccessDirect™ key located above your keyboard that allows you to quickly access a frequently used program, such as Internet Explorer.
- 1 512-MB synchronous dynamic random-access memory (SDRAM).
- 1 Support for the CardBus standard for 32-bit data transfer on PC Cards.
- 1 Three audio jacks for connecting external speakers, headphones, a microphone, or a recording device.
- 1 Integrated microphone and two stereo speakers.
- 1 Hardware and software support for Dell docking devices.
- 1 Dell DualPoint integrated pointing device, which includes both a touch pad and a track stick.
- 1 An 8-cell lithium ion battery (standard) in the battery bay. For lithium ion batteries, the Dell ExpressCharge™ technology charges a single battery in approximately 1 hour when the computer is off or in suspend mode.
- 1 Energy efficiency. An ENERGY STAR® partner, Dell has determined that this product meets the ENERGY STAR guidelines for energy efficiency.
- 1 Two Universal Serial Bus (USB) connectors that support stand-alone and hub devices, and an IEEE 1394 serial connector for attaching high-speed devices.
- 1 HyperCool™ automatic thermal management system that uses variable-speed fans, microprocessor speed changes, and Intel® Remote Heat Exchanger technology to keep the computer running at the optimum temperature.

The following software is included with your Dell computer:

- 1 Microsoft® Windows® 2000 operating system.
- 1 System setup program that lets you view and change the system configuration. For more information, see "[Using the System Setup Program](#)."
- 1 [Dell Diagnostics](#) for evaluating the computer's components and devices.



NOTE: If Dell did not install an operating system on your hard drive, the drivers, system utilities, and diagnostics are available separately from Dell. To order them, see "[Help Overview](#)" for the appropriate telephone number in your location.

Available Options

For information on the available options for your computer, visit the Dell website at <http://www.dell.com>.

[Back to Contents Page](#)

[Back to Contents Page](#)

Front View: Dell Precision™ Mobile Workstation M40 User's Guide

NOTICE: To avoid overheating the computer, do not place any objects close to an air intake or fan.

For information on the computer's connectors and on using devices, see "[Using Your Computer](#)" and "[Connecting Devices](#)."

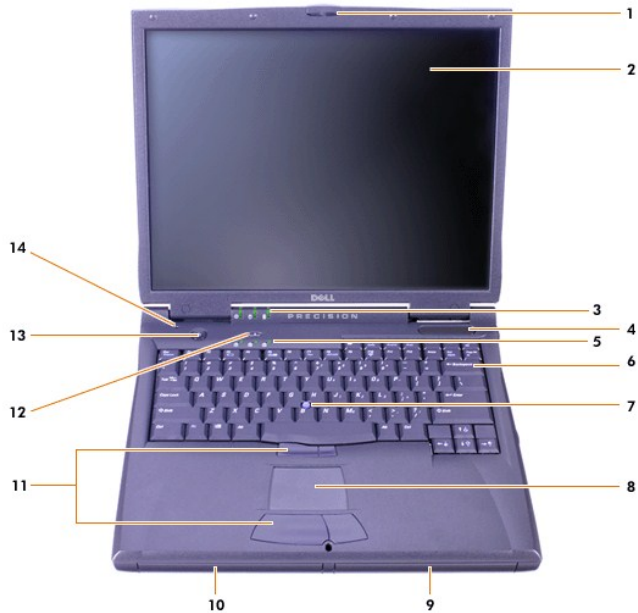

1 Display latch

2 Display

3 [System status lights](#)

4 Air intake

5 [Keyboard status lights](#)

6 Keyboard

7 Track stick

8 Touch pad

9 Battery

10 Modular bay

11 Track stick and touch pad buttons

12 Dell AccessDirect™ key

13 Power button

14 Internal microphone



Status Lights



NOTICE: Never turn off the computer while the  light is on. Doing so could cause data loss. Instead, close all programs before you turn off the computer.



 Power

 Num Lock

 Drive access
 Battery

 Caps Lock
 Scroll Lock

[Back to Contents Page](#)

[Back to Contents Page](#)

Help Overview: Dell Precision™ Mobile Workstation M40 User's Guide

 [Technical Assistance](#)

 [Product Information](#)

 [Help Tools](#)

 [Returning Items for Warranty Repair or Credit](#)

 [Problems With Your Order](#)

 [Before You Call](#)

Technical Assistance

If you need assistance with a technical problem, perform the following steps:

1. Run the Dell Diagnostics.
2. Make a copy of the [Diagnostics Checklist](#) and fill it out.
3. Use Dell's extensive suite of online services available at Dell's World Wide Web site (<http://www.dell.com>) for help with installation and troubleshooting procedures.
4. If the preceding steps have not resolved the problem, call Dell for technical assistance.

When prompted by Dell's automated telephone system, enter your Express Service Code to route the call directly to the proper support personnel. If you do not have an Express Service Code, open the **Dell Accessories** folder, double-click the **Express Service Code** icon, and follow the directions.

 *NOTE: Dell's Express Service Code system may not be available in all countries.*

For instructions on using the technical support service, see "[Technical Support Service](#)" and "[Before You Call](#)."

Help Tools

Dell provides a number of tools to assist you. These tools are described in the following sections.

 *NOTE: Some of the following tools are not always available in all locations outside the continental U.S. Please call your local Dell representative for information on availability.*

World Wide Web

The Internet is your most powerful tool for obtaining information about your computer and other Dell products. Through the Internet, you can access most of the services described in this section, including AutoTech, TechFax, order status, technical support, and product information.

You can access Dell's support Web site at <http://support.dell.com>. To select your country, click the map that appears. The **Welcome to support.dell.com** page opens. Enter your system information to access help tools and information.

You can contact Dell electronically by using the following addresses:

- 1 World Wide Web

<http://www.dell.com/>

<http://www.dell.com/ap/> (for Asian/Pacific countries only)

<http://www.euro.dell.com> (for Europe only)

<http://www.dell.com/la/> (for Latin American countries)

- 1 Anonymous file transfer protocol (FTP)

<ftp.dell.com/>

Log in as user: `anonymous`, and use your e-mail address as your password.

- 1 Electronic Support Service

mobile_support@us.dell.com

support@us.dell.com

apsupport@dell.com (for Asian/Pacific countries only)

support.euro.dell.com (for Europe only)

1 Electronic Quote Service

sales@dell.com

apmarketing@dell.com (for Asian/Pacific countries only)

1 Electronic Information Service

info@dell.com

AutoTech Service

Dell's automated technical support service—AutoTech—provides recorded answers to the questions most frequently asked by Dell customers about their portable and desktop computer systems.

When you call AutoTech, you use your touch-tone telephone to select the subjects that correspond to your questions.

The AutoTech service is available 24 hours a day, seven days a week. You can also access this service through the technical support service. For the telephone number to call, see the [contact numbers](#) for your region.

TechFax Service

Dell takes full advantage of fax technology to serve you better. Twenty-four hours a day, seven days a week, you can call the Dell TechFax line toll-free for all kinds of technical information.

Using a touch-tone phone, you can select from a full directory of topics. The technical information you request is sent within minutes to the fax number you designate. For the TechFax telephone number to call, see the [contact numbers](#) for your region.

Automated Order-Status System

You can call this automated service to check on the status of any Dell products that you have ordered. A recording prompts you for the information needed to locate and report on your order. For the telephone number to call, see the [contact numbers](#) for your region.

Technical Support Service

Dell's industry-leading hardware technical support service is available 24 hours a day, seven days a week, to answer your questions about Dell hardware.

Our technical support staff pride themselves on their track record: more than 90 percent of all problems and questions are taken care of in just one toll-free call, usually in less than 10 minutes. When you call, our experts can see records kept on your Dell system to better understand your particular question. Our technical support staff uses computer-based diagnostics to provide fast, accurate answers to questions.

To contact Dell's technical support service, see "[Before You Call](#)" and then call the number for your country as listed in "[Contacting Dell](#)."

Problems With Your Order

If you have a problem with your order, such as missing parts, wrong parts, or incorrect billing, contact Dell for customer assistance. Have your invoice or packing slip handy when you call. For the telephone number to call, see the [contact numbers](#) for your region.

Product Information

If you need information about additional products available from Dell, or if you would like to place an order, visit Dell's World Wide Web site at <http://www.dell.com>. For the telephone number to call to speak to a sales specialist, see "[Contacting Dell](#)."

Returning Items for Warranty Repair or Credit

Prepare all items being returned, whether for repair or credit, as follows:

1. Call Dell to obtain an authorization number, and write it clearly and prominently on the outside of the box.

For the telephone number to call, see the [contact numbers](#) for your region.

2. Include a copy of the invoice and a letter describing the reason for the return.

3. Include a copy of the [Diagnostics Checklist](#) indicating the tests you have run and any error messages reported by the Dell Diagnostics.
4. Include any accessories that belong with the item(s) being returned (power cables, software diskettes, guides, and so on) if the return is for credit.
5. Pack the equipment to be returned in the original (or equivalent) packing materials.

You are responsible for paying shipping expenses. You are also responsible for insuring any product returned, and you assume the risk of loss during shipment to Dell. Collect On Delivery (C.O.D.) packages are not accepted.

Returns that are missing any of the preceding requirements will be refused at our receiving dock and returned to you.

Before You Call

 **NOTE:** Have your Express Service Code ready when you call. The code helps Dell's automated-support telephone system direct your call more efficiently.

Remember to fill out the [Diagnostics Checklist](#). If possible, turn on your system before you call Dell for technical assistance and call from a telephone at or near the computer. You may be asked to type some commands at the keyboard, relay detailed information during operations, or try other troubleshooting steps possible only at the computer system itself. Make sure the system documentation is available.

 **CAUTION:** If you need to remove the computer covers, be sure to first disconnect the computer system's power and modem cables from all electrical outlets.

Diagnostics Checklist

| |
|--|
| Date: |
| Name: |
| Address: |
| Phone number: |
| Service tag (bar code on the back of the computer): |
| Express Service Code: |
| Return Material Authorization Number (if provided by Dell support technician): |
| Operating system and version: |
| Peripherals: |
| Expansion cards: |
| Are you connected to a network? Yes No |
| Network, version, and network card: |
| Programs and versions: |
| See your operating system documentation to determine the contents of the system's start-up files. If the computer is connected to a printer, print each file. Otherwise, record the contents of each file before calling Dell. |
| Error message, beep code, or diagnostic code: |
| Description of problem and troubleshooting procedures you performed: |

[Back to Contents Page](#)

What You Need to Know: Dell Precision™ Mobile Workstation M40 User's Guide

 [Finding Information](#)

 [Safety and EMC Symbols](#)

 [Safety Instructions](#)

 [EMC Instructions](#)

 [When Using Your Computer](#)

 [Ergonomic Computing Habits](#)

 [When Removing or Installing Memory Modules](#)

 [Protecting Against Electrostatic Discharge](#)

Finding Information

In addition to this *User's Guide*, the following documentation is included with your computer.

 **NOTE:** Documentation updates are sometimes included with your computer to describe changes to your computer or software. Always read these updates **before** consulting any other documentation because the updates contain the latest information.

- 1 An operating system *Setup Guide*, which describes how to set up the operating system installed on your Dell™ computer.
- 1 Online documentation for your computer's devices (such as a modem) and for options you purchase separately from your computer.
 - o In *Windows 2000*, double-click the **Dell User's Guide** icon on the desktop, click **System Information**, and then click **System Documentation**.
- 1 Readme files, which may be installed on your hard drive, provide last-minute updates about technical changes to your computer or advanced technical reference material intended for experienced users or technicians.

For detailed information on the computer's parts and assemblies and how to remove and replace them, see the computer's *Service Manual* on the Dell support website at <http://support.dell.com>.

Safety and EMC Symbols

The following information defines the meaning of *additional* symbols used *only* in the Safety and Electromagnetic Compatibility (EMC) Instructions.



Risk of explosion



Aircraft



Risk of fire



Use of this feature may be prohibited on aircraft





Risk of electric shock



Safety Instructions

General

- 1 Do not attempt to service the computer yourself unless you are a trained service technician. Always follow installation instructions closely.
- 1 If you use an extension power cable with your AC adapter, ensure that the total ampere rating of the products plugged in to the extension power cable does not exceed the ampere rating of the extension cable.
-   1 Do not push objects into air vents or openings of your computer. Doing so can cause fire or electric shock by shorting out interior components.
-  1 Place the AC adapter in a ventilated area, such as a desk top or on the floor, when you use it to run the computer or to charge the battery. Do not cover the AC adapter with papers or other items that will reduce cooling; also, do not use the AC adapter inside a carrying case.
- 1 Do not allow your mobile workstation computer to operate with the base resting directly on exposed skin for extended periods of time. The surface temperature of the base will rise during normal operation (particularly when AC power is

present). Allowing sustained contact with the skin can cause discomfort or, eventually, a burn.



- 1 Do not use your computer in a wet environment, for example, near a bath tub, sink, or swimming pool or in a wet basement.



- 1 If your computer includes an integrated or optional (PC Card) modem, disconnect the modem cable if an electrical storm is approaching to avoid the remote risk of electric shock from lightning via the telephone line.



- 1 To help avoid the potential hazard of electric shock, do not connect or disconnect any cables or perform maintenance or reconfiguration of this product during an electrical storm. Do not use your computer during an electrical storm unless all cables have been disconnected and the computer is operating on battery power.

- 1 If your computer includes a modem, the cable used with the modem should be manufactured with a minimum wire size of 26 American wire gauge (AWG) and an FCC-compliant RJ-11 modular plug.

- 1 PC Cards may become very warm during normal operation. Use care when removing PC Cards after their continuous operation.

- 1 Before you clean your computer, remove power. Clean your computer with a soft cloth dampened with water. Do not use liquid or aerosol cleaners, which may contain flammable substances.



Power (Safety Instructions, continued)



- 1 Use only the Dell-provided AC adapter approved for use with this computer. Use of another AC adapter may cause a fire or explosion.

- 1 Before you connect the computer to an electrical outlet, check the AC adapter voltage rating to ensure that the required voltage and frequency match the available power source.

- 1 To remove power from the computer, turn it off, remove the battery pack, and disconnect the AC adapter from the electrical outlet.



- 1 To help prevent electric shock, plug the AC adapter and peripheral power cables into properly grounded power sources. These power cables may be equipped with three-prong plugs to provide an earth grounding connection. Do not use adapter plugs or remove the grounding prong from the power cable plug. If you use a power extension cable, use the appropriate type, two-prong or three-prong, to mate with the AC adapter power cable.

- 1 Be sure that nothing rests on your AC adapter's power cable and that the cable is not located where it can be tripped over or stepped on.



- 1 If you are using a multiple-outlet power strip, use caution when plugging the AC adapter's power cable into the power strip. Some power strips may allow you to insert the plug incorrectly. Incorrect insertion of the power plug could result in permanent damage to your computer, as well as risk of electric shock and/or fire. Ensure that the ground prong of the power plug is inserted into the mating ground contact of the power strip.



Battery (Safety Instructions, continued)



- 1 Use only Dell battery modules that are approved for use with this computer. Use of other types may increase the risk of fire or explosion.



- 1 Do not carry a battery pack in your pocket, purse, or other container where metal objects (such as car keys or paper clips) could short-circuit the battery terminals. The resulting excessive current flow can cause extremely high temperatures and may result in damage to the battery pack or cause fire or burns.

- 1 The battery poses a burn hazard if you handle it improperly. Do not disassemble it. Handle a damaged or leaking battery pack with extreme care. If the battery is damaged, electrolyte may leak from the cells and may cause personal injury.

- 1 Keep the battery away from children.



- 1 Do not store or leave your computer or battery pack near a heat source such as a radiator, fireplace, stove, electric heater, or other heat-generating appliance or otherwise expose it to temperatures in excess of 60°C (140°F). When heated to excessive temperatures, battery cells could explode or vent, posing a risk of fire.



- 1 Do not dispose of your computer's battery in a fire or with normal household waste. Battery cells may explode. Discard a used battery according to the manufacturer's instructions or contact your local waste disposal agency for disposal instructions. Dispose of a spent or damaged battery promptly.



Air Travel (Safety Instructions, continued)



- 1 Certain Federal Aviation Administration regulations and/or airline-specific restrictions may apply to the operation of your Dell computer while you are onboard an aircraft. For example, such regulations/restrictions may prohibit the use of any personal electronic device (PED) that has the capacity for intentional transmission of radio frequency or other electromagnetic signals while on an aircraft.



- o In order to best comply with all such restrictions, if your Dell mobile workstation computer is equipped with Dell TrueMobile™ or some other wireless communication device, please disable this device before you board the aircraft and follow all instructions provided by airline personnel with regard to such device.



- o Additionally, the use of any PED, such as a mobile workstation computer, may be prohibited in aircraft during certain critical phases of flight, for example, takeoff and landing. Some airlines may further define the critical flight phase as any time the aircraft is below 3050 m (10,000 ft). Please follow the airline's specific instructions as to when the use of a PED is allowed.

EMC Instructions

- 1 Use shielded signal cables to ensure that you maintain the appropriate EMC classification for the intended environment. For parallel printers, a cable is available from Dell. If you prefer, you can order a cable from Dell at its world-wide website at <http://www.dell.com>.
- 1 Static electricity can harm electronic components inside your computer. To prevent static damage, discharge static electricity from your body before you touch any of your computer's electronic components, such as a memory module. You can do so by touching an unpainted metal surface on the computer's input/output panel.

When Using Your Computer

Observe the following guidelines to prevent damage to your computer.

- 1 When setting up the computer for work, place it on a level surface.
- 1 When traveling, do not check the computer as baggage. You can put your computer through an X-ray security machine, but *never* put your computer through a metal detector. If you have the computer checked by hand, be sure to have a charged battery available in case you are asked to turn on the computer.
- 1 When traveling with the hard drive removed from the computer, wrap the drive in a nonconducting material, such as cloth or paper. If you have the drive checked by hand, be ready to install the drive in the computer. You can put the hard drive through an X-ray security machine, but *never* put the drive through a metal detector.
- 1 When traveling, do not place the computer in overhead storage compartments where it could slide around. Do not drop your computer or subject it to other mechanical shocks.
- 1 Protect your computer, battery, and hard drive from environmental hazards such as dirt, dust, food, liquids, temperature extremes, and overexposure to sunlight.
- 1 When you move your computer between environments with very different temperature and/or humidity ranges, condensation may form on or within the computer. To avoid damaging the computer, allow sufficient time for the moisture to evaporate before using the computer.

NOTICE: When taking the computer from low-temperature conditions into a warmer environment or from high-temperature conditions into a cooler environment, allow the computer to acclimate to room temperature before turning on power.

- 1 When you disconnect a cable, pull on its connector or on its strain-relief loop, not on the cable itself. As you pull out the connector, keep it evenly aligned to avoid bending any connector pins. Also, before you connect a cable make sure both connectors are correctly oriented and aligned.
- 1 Handle components with care. Hold a component such as a memory module by its edges, not its pins.
- 1 When removing a memory module from the system board or disconnecting a peripheral device from the computer, wait 5 seconds after

turning off the computer before removing the memory module or disconnecting the device to help avoid possible damage to the system board.

- 1 Clean the display with a soft, clean cloth and commercial window cleaner that does not contain wax or abrasives. Apply the cleaner to the cloth; then stroke the cloth across the display in one direction, moving from the top of the display to the bottom. If the display contains grease or some other contaminant, use isopropyl alcohol instead of commercial window cleaner.
- 1 If your computer gets wet or is damaged, follow the procedures described in "[Finding Solutions](#)." If, after following these procedures, you confirm that your computer is not operating properly, [contact Dell](#).

Ergonomic Computing Habits

⚠ CAUTION: Improper or prolonged keyboard use may result in injury.

⚠ CAUTION: Viewing the display or external monitor screen for extended periods of time may result in eye strain.

For comfort and efficiency, observe the following ergonomic guidelines when setting up and using your computer:

- 1 Position your computer directly in front of you as you work.
- 1 Adjust the tilt of the computer's display, its contrast and/or brightness settings, and the lighting around you (such as overhead lights, desk lamps, and the curtains or blinds on nearby windows) to minimize reflections and glare on the display.
- 1 When using an external monitor with your computer, set the monitor at a comfortable viewing distance (usually 510 to 610 millimeters [20 to 24 inches] from your eyes). Make sure the monitor screen is at eye level or slightly lower when you are sitting in front of the monitor.
- 1 Use a chair that provides good lower-back support.
- 1 Keep your forearms horizontal with your wrists in a neutral, comfortable position while using the keyboard, touch pad, track stick, or external mouse.
- 1 Always use the palmrest with the keyboard, touch pad, or track stick. Leave space to rest your hands when using an external mouse.
- 1 Let your upper arms hang naturally at your sides.
- 1 Sit erect with your feet resting on the floor and your thighs level.
- 1 When sitting, make sure the weight of your legs is on your feet and not on the front of your chair seat. Adjust your chair's height or use a footrest, if necessary, to maintain proper posture.
- 1 Vary your work activities. Try to organize your work so that you do not have to type for extended periods of time. When you stop typing, try to do things that use both hands.

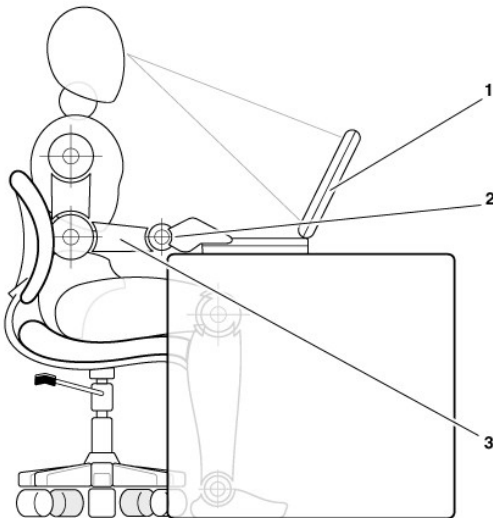

- 1 Computer positioned directly in front of user
- 2 Wrists relaxed and flat
- 3 Arms at desk level

When Removing or Installing Memory Modules

Before removing or installing memory modules, perform the following steps in the sequence indicated.

NOTICE: The only time you should ever access the inside of your computer is when you are installing memory modules.

NOTICE: Wait 5 seconds after turning off the computer before disconnecting a peripheral device or removing a memory module to help prevent possible damage to the system board.

1. Turn off your computer and any attached peripherals.
2. Disconnect your computer and peripherals from AC power to reduce the potential for personal injury or shock. Also, disconnect any telephone or telecommunication lines from the computer.
3. Remove the main battery from the battery compartment and, if necessary, the secondary battery from the options bay.
4. Ground yourself by touching the unpainted metal surface of the input/output (I/O) panel on the back of the computer.

While you work, periodically touch the I/O panel to dissipate any static electricity that might harm internal components.

Protecting Against Electrostatic Discharge

Static electricity can harm electronic components inside your computer. To prevent static damage, discharge static electricity from your body before you touch any of your computer's electronic components, such as a memory module. You can do so by touching an unpainted metal surface on the computer's I/O panel.

As you continue to work inside the computer, periodically touch an I/O connector to remove any static charge your body may have accumulated.

You can also take the following steps to prevent damage from electrostatic discharge (ESD):

1. When unpacking a static-sensitive component from its shipping carton, do not remove the component from the antistatic packing material until you are ready to install the component. Just before unwrapping the antistatic packaging, be sure to discharge static electricity from your body.
1. When transporting a sensitive component, first place it in an antistatic container or packaging.
1. Handle all sensitive components in a static-safe area. If possible, use antistatic floor pads and workbench pads.

The following notice may appear throughout this document to remind you of these precautions:

NOTICE: See "Protecting Against Electrostatic Discharge" in the safety instructions at the front of this guide.

[Back to Contents Page](#)

Conserving Power: Dell Precision™ Mobile Workstation M40 User's Guide

[Management Tips](#)

[Power Options Properties](#)

[Power Management Modes](#)

[ENERGY STAR® Emblem](#)

Management Tips

 **NOTE:** See "[About the Batteries](#)" for more information on conserving battery power.

- 1 Connect the computer to an electrical outlet when possible, because the battery life expectancy is largely determined by the number of times it is charged.
- 1 Place the computer in [standby mode](#) or [hibernate mode](#) when you leave the computer unattended for long periods of time.
- 1 If you are going to connect your computer to a port replicator or a docking station, click **None** (or **Do nothing**) when you program the display-close option in the [Advanced](#) tab in the Microsoft® Windows® **Power Options Properties** window.
- 1 To exit a power management mode, press the power button.

Power Management Modes

Standby Mode

Standby mode conserves power by turning off the display and the hard drive after a predetermined period of inactivity (a time-out). When you exit standby mode, the computer returns to the same state it was in before entering standby mode.

NOTICE: If your computer loses AC and battery power while in standby mode, you may lose data.

To enter standby mode:

- 1 In *Microsoft Windows 2000*, click the **Start** button, click **Shutdown**, click **Standby**, and then click **OK**.
- or
- 1 Depending on how you set the power management options in the [Advanced](#) tab, use one of the following methods:
 - o Press the power button.
 - o Close the display.
 - o Press the power management keyboard shortcut (sometimes referred to as the "sleep button"), .

If an external monitor is connected to the computer when you close the display, the computer does not enter standby mode. You can still use the external monitor.

To exit standby mode, press the power button or open the display depending on how you set the options in the [Advanced](#) tab.

Hibernate Mode (Suspend-to-Disk Mode)

Hibernate mode (also called suspend-to-disk or S2D mode) conserves power by copying system data to a reserved area on the hard drive and then completely turning off the computer. When you exit hibernate mode, the computer returns to the same state it was in before entering hibernate mode.

NOTICE: You cannot remove devices or undock your computer while in hibernate mode.

Your computer enters hibernate mode if the battery charge level becomes critically low.

Depending on how you set the power management options in the [Advanced](#) tab, use one of the following methods to enter hibernate mode:

- 1 Press the power button.
- 1 Close the display.
- 1 Press the power management keyboard shortcut (sometimes referred to as the "sleep button"), .

If an external monitor is connected to the computer when you close the display, the computer does not enter hibernate mode. You can still use the external monitor.

 **NOTE:** You cannot exit standby mode or hibernate mode by pressing a key or touching the touch pad.

 **NOTE:** Some PC Cards may not operate correctly after the computer exits hibernate mode. Remove and reinsert the card, or simply restart (reboot) your computer.

To exit hibernate mode, press the power button. The computer may take a short time to exit hibernate mode.

For more information on hibernate mode, see the documentation that came with your operating system.

Power Options Properties

To access the Windows **Power Options Properties** window:

For Windows 2000

1. Click the **Start** button, point to **Settings**, and then click **Control Panel**.
2. Double-click the **Power Options** icon.

Power Schemes Tab

The **Power schemes** pull-down menu displays the selected preset power scheme. Depending on your operating system, typical power schemes are:

 **NOTE:** Dell recommends that you use the **Portable/Laptop** power scheme to maximize battery power.

- 1 **Portable/Laptop**
- 1 **Home/Office**
- 1 **Always On**
- 1 **Presentation**
- 1 **Minimal Power Management**
- 1 **Max Battery**

Each preset power scheme has different time-out settings for putting the computer into standby mode, turning off the display, and turning off the hard drive. For more information on power management options, see *Windows Help* (in Windows 2000).

Alarms Tab

 **NOTE:** To enable audible alarms, click each **Alarm Action** button and select **Sound alarm**.

The **Low battery alarm** and **Critical battery alarm** settings alert you with a message when the battery charge falls below a certain percentage. When you receive your computer, the **Low battery alarm** and **Critical battery alarm** check boxes are selected. Dell recommends that you continue to use these settings. See "[Battery Warnings](#)" for more information on low battery warnings.

Power Meter Tab

The **Power Meter** tab displays the current power source and amount of battery charge remaining.

Advanced Tab

The **Advanced** tab allows you to:

- 1 Set power icon and standby mode password options.

 **NOTE:** If you are going to connect your computer to a port replicator or a docking station, click **None** when you program the display-close option. This setting ensures that your computer does not enter standby mode or hibernate mode when you close (lower) the display.

- 1 Program the following functions:
 - o Activate standby mode.
 - o Activate hibernate mode.
 - o Shut down Windows and turn off the computer.
 - o Choose no action (**None**).

To program these functions, click an option from the corresponding pull-down menu, and then click **OK**.

Hibernate Tab

The **Hibernate** tab lets you enable hibernate mode by clicking the **Enable hibernate support** check box.



ENERGY STAR® Emblem

The EPA's ENERGY STAR® Computers program is a joint effort between the EPA and computer manufacturers to reduce air pollution by promoting energy-efficient computer products. The EPA estimates that use of ENERGY STAR® computer products can save computer users up to two billion dollars annually in electricity costs.

[Back to Contents Page](#)

[Back to Contents Page](#)

Regulatory Notices: Dell Precision™ Mobile Workstation M40 User's Guide

- [Overview](#)
 - [FCC Notices \(U.S. Only\)](#)
 - [IC Notice \(Canada Only\)](#)
 - [CE Notice \(European Union\)](#)
 - [Battery Disposal](#)
 - [EN 55022 Compliance \(Czech Republic Only\)](#)
 - [VCCI Notice \(Japan Only\)](#)
 - [MIC Notice \(Republic of Korea Only\)](#)
 - [Polish Center for Testing and Certification Notice](#)
 - [Wymagania Polskiego Centrum Badan i Certyfikacji](#)
 - [Pozostale instrukcje bezpieczenstwa](#)
 - [NOM Information \(Mexico Only\)](#)
 - [Información para NOM \(únicamente para México\)](#)
 - [BSMI Notice \(Taiwan Only\)](#)
 - [CE Mark Notice](#)
 - [New Zealand Telecom Warnings](#)
-

Overview

Electromagnetic Interference (EMI) is any signal or emission, radiated in free space or conducted along power or signal leads, that endangers the functioning of a radio navigation or other safety service or seriously degrades, obstructs, or repeatedly interrupts a licensed radio communications service. Radio communications services include but are not limited to AM/FM commercial broadcast, television, cellular services, radar, air-traffic control, pager, and Personal Communication Services (PCS). These licensed services, along with unintentional radiators such as digital devices, including computers, contribute to the electromagnetic environment.

Electromagnetic Compatibility (EMC) is the ability of items of electronic equipment to function properly together in the electronic environment. While this computer has been designed and determined to be compliant with regulatory agency limits for EMI, there is no guarantee that interference will not occur in a particular installation. If this equipment does cause interference with radio communications services, which can be determined by turning the equipment off and on, you are encouraged to try to correct the interference by one or more of the following measures:

- 1 Reorient the receiving antenna.
- 1 Relocate the computer with respect to the receiver.
- 1 Move the computer away from the receiver.
- 1 Plug the computer into a different outlet so that the computer and the receiver are on different branch circuits.

If necessary, consult a Dell Technical Support representative or an experienced radio/television technician for additional suggestions.

Dell computers are designed, tested, and classified for their intended electromagnetic environment. These electromagnetic environment classifications generally refer to the following harmonized definitions:

- 1 Class A is typically for business or industrial environments.
- 1 Class B is typically for residential environments.

Information Technology Equipment (ITE), including peripherals, expansion cards, printers, input/output (I/O) devices, monitors, and so on, that are integrated into or connected to the computer should match the electromagnetic environment classification of the computer.

A Notice About Shielded Signal Cables: Use only shielded cables for connecting peripherals to any Dell device to reduce the possibility of interference with radio communications services. Using shielded cables ensures that you maintain the appropriate EMC classification for the intended environment. For parallel printers, a cable is available from Dell. If you prefer, you can order a cable from Dell on the World Wide Web at <http://accessories.us.dell.com>.

Most Dell computers are classified for Class B environments. However, the inclusion of certain options can change the rating of some configurations to Class A. To determine the electromagnetic classification for your computer or device, refer to the following sections specific for each regulatory agency. Each section provides country-specific EMC/EMI or product safety information.

FCC Notices (U.S. Only)

Most Dell computers are classified by the Federal Communications Commission (FCC) as Class B digital devices. To determine which classification applies to your computer, examine all FCC registration labels located on the bottom or back panel of your computer, on card-mounting brackets, and on the cards themselves. If any one of the labels carries a Class A rating, your entire computer is considered to be a Class A digital device. If *all* labels carry an FCC Class B rating as distinguished by either an FCC ID number or the FCC logo (FC), your computer is considered to be a Class B digital device.

Once you have determined your computer's FCC classification, read the appropriate FCC notice. Note that FCC regulations provide that changes or modifications not expressly approved by Dell could void your authority to operate this equipment.

This device complies with Part 15 of the FCC Rules. Operation is subject to the following two conditions:

- 1 This device may not cause harmful interference.
- 1 This device must accept any interference received, including interference that may cause undesired operation.

Class A

This equipment has been tested and found to comply with the limits for a Class A digital device pursuant to Part 15 of the FCC Rules. These limits are designed to provide reasonable protection against harmful interference when the equipment is operated in a commercial environment. This equipment generates, uses, and can radiate radio frequency energy and, if not installed and used in accordance with the manufacturer's instruction manual, may cause harmful interference with radio communications. Operation of this equipment in a residential area is likely to cause harmful interference, in which case you will be required to correct the interference at your own expense.

Class B

This equipment has been tested and found to comply with the limits for a Class B digital device pursuant to Part 15 of the FCC Rules. These limits are designed to provide reasonable protection against harmful interference in a residential installation. This equipment generates, uses, and can radiate radio frequency energy and, if not installed and used in accordance with the manufacturer's instruction manual, may cause interference with radio communications. However, there is no guarantee that interference will not occur in a particular installation. If this equipment does cause harmful interference to radio or television reception, which can be determined by turning the equipment off and on, you are encouraged to try to correct the interference by one or more of the following measures:

- 1 Reorient or relocate the receiving antenna.
- 1 Increase the separation between the equipment and the receiver.
- 1 Connect the equipment into an outlet on a circuit different from that to which the receiver is connected.
- 1 Consult the dealer or an experienced radio/television technician for help.

The following information is provided on the device or devices covered in this document in compliance with FCC regulations:

- 1 Model number: PP01X
- 1 Company name:

Dell Computer Corporation
One Dell Way
Round Rock, Texas 78682 USA

Modem Regulatory Information

This equipment complies with Part 68 of the FCC rules. On the bottom of your computer is a label that contains, among other information, the FCC registration number and ringer equivalence number (REN) for your equipment. If requested, you must provide this information to the telephone company.

The REN is used to determine the quantity of devices that may be connected to the telephone line. Excessive RENs on the telephone line may result in the devices not ringing in response to an incoming call. In most areas, the sum of all the RENs on your telephone line should be less than five to ensure proper service from the telephone company. To be certain of the number of devices that you may connect to a line, as determined by the total RENs, contact your local telephone company.

The registration jack Universal Service Order Code (USOC) used by this equipment is RJ-11C. An FCC compliant telephone cord and modular plug is provided with this equipment. This equipment is designed to be connected to the telephone network or premises wiring using a compatible modular jack that is Part 68 compliant.

This equipment cannot be used on public coin-phone service provided by the telephone company. Connection to party line service is subject to state tariffs.

There are no user serviceable parts on the modem contained in your computer.

If your telephone equipment causes harm to the telephone network, the telephone company will notify you in advance that service may be temporarily discontinued. If advance notice is not practical, the telephone company will notify you as soon as possible. Also, you will be advised of your right to file a complaint with the FCC if you believe it is necessary.

The telephone company may make changes in its facilities, equipment, operations, or procedures that could affect the operation of this equipment. If this happens, the telephone company will provide advance notice in order for you to make necessary modifications to maintain uninterrupted service.

If you experience trouble with this telephone equipment, refer to the chapter titled "Getting Help" in your Dell *User's Guide* or the section titled "Contacting Dell" in your Dell *User's Guide* to find the appropriate telephone number for obtaining customer assistance. If the equipment is causing harm to the telephone network, the telephone company may request that you disconnect the equipment until the problem is resolved.

Fax Branding

The Telephone Consumer Protection Act of 1991 makes it unlawful for any person to use a computer or other electronic device, including fax machines, to send any message unless such message clearly contains in a margin at the top or bottom of each transmitted page or on the first page of the transmission, the date and time it is sent, identification of the business, other entity, or individual sending the message, and the telephone number of the sending machine or such business, other entity, or individual. The telephone number provided may not be a 900 number or any other number for which charges exceed local or long-distance transmission charges.

IC Notice (Canada Only)

Most Dell computers (and other Dell digital apparatus) are classified by the Industry Canada (IC) Interference-Causing Equipment Standard #3 (ICES-003) as Class B digital devices. To determine which classification (Class A or B) applies to your computer (or other Dell digital apparatus), examine all registration labels located on the bottom or the back panel of your computer (or other digital apparatus). A statement in the form of "IC Class A ICES-003" or "IC Class B ICES-003" will be located on one of these labels. Note that Industry Canada regulations provide that changes or modifications not expressly approved by Dell could void your authority to operate this equipment.

This Class B (or Class A, if so indicated on the registration label) digital apparatus meets the requirements of the Canadian Interference-Causing Equipment Regulations.

Cet appareil numérique de la Classe B (ou Classe A, si ainsi indiqué sur l'étiquette d'enregistrement) respecte toutes les exigences du Règlement sur le Matériel Brouilleur du Canada.

Modem Regulatory Information

The IC label identifies certified equipment. This certification means that the equipment meets telecommunications network protective, operational, and safety requirements as prescribed in the appropriate Terminal Equipment Technical Requirements document(s). The IC label does not guarantee that the equipment will operate to the user's satisfaction.

Before installing this equipment, users should ensure that it is permissible to be connected to the facilities of the local telecommunications company. The equipment must also be installed using an acceptable method of connection. The customer should be aware that compliance with the above conditions may not prevent degradation of service in some situations.

Repairs to certified equipment should be coordinated by a representative designated by the supplier. Any repairs or alteration made by a user to this equipment, or equipment malfunctions, may give the telephone communications company cause to request the user to disconnect the equipment.

Users should ensure for their own protection, that the electrical ground connections of the power utility, telephone lines, and internal metallic water-pipe system, if present, are connected together. This precaution may be particularly important in rural areas.

NOTICE: Users should not attempt to make such connections themselves. Contact the appropriate electric inspection authority, or electrician, as appropriate.



NOTE: The REN assigned to each terminal device provides an indication of the maximum number of terminals allowed to be connected to a telephone interface. The termination on an interface may consist of any combination of devices subject only to the requirement that the sum of the RENs of all the devices does not exceed the number five.

The REN for the internal modem as stated on the IC regulatory label located on the bottom of the computer is 0.6B.

The following information is provided in compliance with IC regulations:

Dell Computer Corporation
One Dell Way
Round Rock, TX 78682 USA

CE Notice (European Union)

Marking by the symbol  indicates compliance of this Dell system to the EMC Directive and the Low Voltage Directive of the European Union. Such marking is indicative that this Dell system meets the following set of technical standards:

- 1 EN 55022 — "Limits and Methods of Measurement of Radio Interference Characteristics of Information Technology Equipment."
- 1 EN 55024 — "Information technology equipment - Immunity characteristics - Limits and methods of measurement."
- 1 EN 61000-3-2 — "Electromagnetic compatibility (EMC) - Part 3: Limits - Section 2: Limits for harmonic current emissions (Equipment input current up to and including 16 A per phase)."
- 1 EN 61000-3-3 — "Electromagnetic compatibility (EMC) - Part 3: Limits - Section 3: Limitation of voltage fluctuations and flicker in low-voltage supply systems for equipment with rated current up to and including 16 A."
- 1 EN 60950 — "Safety of Information Technology Equipment."

 NOTE: EN 55022 emissions requirements provide for two classifications:

- 1 Class A is for typical commercial areas.
- 1 Class B is for typical domestic areas.

RF INTERFERENCE WARNING: This is a Class A product. In a domestic environment this product may cause radio frequency (RF) interference, in which case the user may be required to take adequate measures.

This Dell device is classified for use in a typical Class B domestic environment.

A "Declaration of Conformity" in accordance with the preceding directives and standards has been made and is on file at Dell Computer Corporation Products Europe BV, Limerick, Ireland.



Battery Disposal

Your computer uses a lithium-ion battery pack and a nickel-metal hydride (NiMH) coin-cell battery. For instructions about replacing the lithium-ion battery pack in your computer, see "[Removing a Battery](#)" in your *Dell User's Guide*. The nickel-metal hydride (NiMH) coin-cell battery is a long-life battery, and it is very possible that you will never need to replace it. However, should you need to replace it, the procedure must be performed by an authorized service technician.

Do not dispose of these batteries along with household waste. Contact your local waste disposal agency for the address of the nearest battery deposit site.

EN 55022 Compliance (Czech Republic Only)

This device belongs to Class B devices as described in EN 55022, unless it is specifically stated that it is a Class A device on the specification label. The following applies to devices in Class A of EN 55022 (radius of protection up to 30 meters). The user of the device is obliged to take all steps necessary to remove sources of interference to telecommunication or other devices.

Pokud není na typovém štítku počítače uvedeno, že spadá do třídy A podle EN 55022, spadá automaticky do třídy B podle EN 55022. Pro zařízení zařazená do třídy A (ochranné pásmo 30m) podle EN 55022 platí následující. Dojde-li k rušení telekomunikačních nebo jiných zařízení, je uživatel povinen provést taková opatření, aby rušení odstranil.

VCCI Notice (Japan Only)

Most Dell computers are classified by the Voluntary Control Council for Interference (VCCI) as Class B information technology equipment (ITE). However, the inclusion of certain options can change the rating of some configurations to Class A. ITE, including peripherals, expansion cards, printers, input/output (I/O) devices, monitors, and so on, integrated into or connected to the computer, should match the electromagnetic environment classification (Class A or B) of the computer.

To determine which classification applies to your computer, examine the regulatory labels/markings (see [Figure 1](#) and [Figure 2](#)) located on the bottom or back panel of your computer. Once you have determined your computer's VCCI classification, read the appropriate VCCI notice.

Class A ITE

この装置は、情報処理装置等電波障害自主規制協議会 (VCCI) の基準に基づくクラス A 情報技術装置です。この装置を家庭環境で使用すると電波妨害を引き起こすことがあります。この場合には使用者が適切な対策を講ずるよう要求されることがあります。

This is a Class A product based on the standard of the Voluntary Control Council for Interference (VCCI) for information technology equipment. If this equipment is used in a domestic environment, radio disturbance may arise. When such trouble occurs, the user may be required to take corrective actions.

Figure 1. VCCI Class A ITE Regulatory Mark

VCCI-A

Class B ITE

この装置は、情報処理装置等電波障害自主規制協議会（VCCI）の基準に基づくクラス B 情報技術装置です。この装置は家庭環境で使用することを目的としていますが、ラジオやテレビジョン受信機に近接して使用されると、受信障害を引き起こすことがあります。
取扱説明書に従って正しい取り扱いをしてください。

This is a Class B product based on the standard of the Voluntary Control Council for Interference (VCCI) for information technology equipment. If this equipment is used near a radio or television receiver in a domestic environment, it may cause radio interference. Install and use the equipment according to the instruction manual.

Figure 2. VCCI Class B ITE Regulatory Mark



MIC Notice (Republic of Korea Only)

To determine which classification (Class A or B) applies to your computer system (or other Dell digital device), examine the Republic of Korean Ministry of Information and Communications (MIC) registration labels located on your computer (or other Dell digital device). The MIC label may be located separately from the other regulatory marking applied to your product. Line three of the label identifies the emissions class for the product—“(A)” for Class A products or “(B)” for Class B products.

NOTE: MIC emissions requirements provide for two classifications:

- 1. Class A devices are for business purposes.
- 1. Class B devices are for nonbusiness purposes.

Class A Device

| 기종별 | 사용자 안내문 |
|-----------------------|---|
| A급 기기 (업무용 정보통신기기) | 이 기기는 업무용으로 전자파적합등록을 한 기기이오니 판매자 또는 사용자는 이 점을 주의하시기 바라며 만약 잘못 판매 또는 구입하였을 때에는 가정용으로 교환하시기 바랍니다. |

Please note that this device has been approved for business purposes with regard to electromagnetic interference. If you find that this device is not suitable for your use, you may exchange it for a nonbusiness-purpose device.

MIC Class A Regulatory Label



1. 기기의 명칭(모델명) :
2. 인증번호 :
3. 인증받은 자의 상호 : (A)
4. 제조년월일 :
5. 제조자/제조국가 :

Class B Device

| 기종별 | 사용자 안내문 |
|-----------------------|--|
| B급 기기 (가정용 정보통신기기) | 이 기기는 가정용으로 전자파적합등록을 한 기기로서 주거지역에서는 물론 모든 지역에서 사용할 수 있습니다. |

Please note that this device has been approved for nonbusiness purposes and may be used in any environment, including residential areas.

MIC Class B Regulatory Label



1. 기기의 명칭(모델명) :
2. 인증번호 :
3. 인증받은 자의 상호 : (B)
4. 제조년월일 :
5. 제조자/제조국가 :

Polish Center for Testing and Certification Notice

The equipment should draw power from a socket with an attached protection circuit (a three-prong socket). All equipment that works together (computer, monitor, printer, and so on) should have the same power supply source.

The phasing conductor of the room's electrical installation should have a reserve short-circuit protection device in the form of a fuse with a nominal value no larger than 16 amperes (A).

To completely switch off the equipment, the power supply cable must be removed from the power supply socket, which should be located near the equipment and easily accessible.

A protection mark "B" confirms that the equipment is in compliance with the protection usage requirements of standards PN-93/T-42107 and PN-EN 55022: 1996.

Wymagania Polskiego Centrum Badań i Certyfikacji

Urządzenie powinno być zasilane z gniazda z przyłączonym obwodem ochronnym (gniazdo z kołkiem). Współpracujące ze sobą urządzenia (komputer, monitor, drukarka) powinny być zasilane z tego samego źródła.

Instalacja elektryczna pomieszczenia powinna zawierać w przewodzie fazowym rezerwową ochronę przed zwarciami, w postaci bezpiecznika o wartości znamionowej nie większej niż 16A (amperów).

W celu całkowitego wyłączenia urządzenia z sieci zasilania, należy wyjąć wtyczkę kabla zasilającego z gniazdka, które powinno znajdować się w pobliżu urządzenia i być łatwo dostępne.

Znak bezpieczeństwa "B" potwierdza zgodność urządzenia z wymaganiami bezpieczeństwa użytkowania zawartymi w PN-93/T-42107 i PN-EN 55022:1996.

Jeżeli na tabliczce znamionowej umieszczono informację, że urządzenie jest klasy A, to oznacza to, że urządzenie w środowisku mieszkalnym może powodować zakłócenia radioelektryczne. W takich przypadkach można żądać od jego użytkownika zastosowania odpowiednich środków zaradczych.

Pozostałe instrukcje bezpieczeństwa

- Nie należy używać wtyczek adapterowych lub usuwać kołka obwodu ochronnego z wtyczki. Jeżeli konieczne jest użycie przedłużacza to należy użyć przedłużacza 3-żyłowego z prawidłowo połączonym przewodem ochronnym.
 - System komputerowy należy zabezpieczyć przed nagłymi, chwilowymi wzrostami lub spadkami napięcia, używając eliminatora przepięć, urządzenia dopasowującego lub bezzakłóceniewego źródła zasilania.
 - Należy upewnić się, aby nic nie leżało na kablach systemu komputerowego, oraz aby kable nie były umieszczone w miejscu, gdzie można byłoby na nie nadeptywać lub potykać się o nie.
 - Nie należy rozlewać napojów ani innych płynów na system komputerowy.
 - Nie należy wpychać żadnych przedmiotów do otworów systemu komputerowego, gdyż może to spowodować pożar lub porażenie prądem, poprzez zwarcie elementów wewnętrznych.
 - System komputerowy powinien znajdować się z dala od grzejników i źródeł ciepła. Ponadto, nie należy blokować otworów wentylacyjnych. Należy unikać kładzenia luźnych papierów pod komputer oraz umieszczania komputera w ciasnym miejscu bez możliwości cyrkulacji powietrza wokół niego.
-

NOM Information (Mexico Only)

The following information is provided on the device(s) described in this document in compliance with the requirements of the official Mexican standards (NOM)

| | |
|-----------|---|
| Exporter: | Dell Computer Corporation One Dell Way Round Rock, TX 78682 |
| Importer: | Dell Computer de México, S.A. de C.V. Paseo de la Reforma 2620 - 11° Piso Col. Lomas Altas 11950 México, D.F. |
| Ship to: | Dell Computer de México, S.A. de C.V. al Cuidado de Kuehne & Nagel de México S. de R.I. |

Avenida Soles No. 55
Col. Peñon de los Baños
15520 México, D.F.

Supply input voltage: 100–240 VAC
Frequency: 50–60 Hz
Current consumption: 1.5 A
Output voltage: 20 VDC
Output current: 3.5 A

Información para NOM (únicamente para México)

La información siguiente se proporciona en el dispositivo o en los dispositivos descritos en este documento, en cumplimiento con los requisitos de la Norma Oficial Mexicana (NOM):

Exportador: Dell Computer Corporation
One Dell Way
Round Rock, TX 78682

Importador: Dell Computer de México,
S.A. de C.V.
Paseo de la Reforma 2620 - 11° Piso
Col. Lomas Altas
11950 México, D.F.

Embarcar a: Dell Computer de México, S.A. de C.V.
al Cuidado de Kuehne & Nagel de
México S. de R.I.
Avenida Soles No. 55
Col. Peñon de los Baños
15520 México, D.F.

Voltaje de entrada de alimentación: 100–240 VAC
Frecuencia: 50–60 Hz
Consumo eléctrico: 1.5 A
Output voltage: 20 VDC
Corriente de salida: 3.5 A

BSMI Notice (Taiwan Only)

BSMI 通告（僅限於台灣）

大多數的 Dell 電腦系統被 BSMI(經濟部標準檢驗局)劃分為乙類數位裝置。但是，使用某些選件會使有些組態的等級變成甲類。若要確定您的電腦系統適用等級，請檢查所有位於電腦底部或背面板、擴充卡安裝托架，以及擴充卡上的 BSMI 註冊標籤。如果其中有一甲類標籤，即表示您的系統為甲類數位裝置。如果只有 BSMI 的檢磁號碼標籤，則表示您的系統為乙類數位裝置。

一旦確定了系統的 BSMI 等級，請閱讀相關的 BSMI 通告。請注意，BSMI 通告規定凡是未經 Dell Computer Corporation 明確批准的擅自變更或修改，將導致您失去此設備的使用權。

此裝置符合 BSMI(經濟部標準檢驗局)的規定，使用時須符合以下兩項條件：

- 此裝置不會產生有害干擾。
- 此裝置必須能接受所接收到的干擾，包括可能導致無法正常作業的干擾。

甲類

此設備經測試證明符合 BSMI(經濟部標準檢驗局)之甲類數位裝置的限制規定。這些限制的目的是為了在商業環境中使用此設備時，能提供合理的保護以防止有害的干擾。此設備會產生、使用並散發射頻能量；如果未遵照製造廠商的指導手冊來安裝和使用，可能會干擾無線電通訊。請勿在住宅區使用此設備。

警告使用者：

這是甲類的資訊產品，在居住的環境中使用時，可能會造成射頻干擾，在這種情況下，使用者會被要求採取某些適當的對策。

乙類

此設備經測試證明符合 BSMI(經濟部標準檢驗局)之乙類數位裝置的限制規定。這些限制的目的是為了在住宅區安裝時，能防止有害的干擾，提供合理的保護。此設備會產生、使用並散發射頻能量；如果未遵照製造廠商的指導手冊來安裝和使用，可能會干擾無線電通訊。但是，這並不保證在個別的安裝中不會產生干擾。您可以透過關閉和開啓此設備來判斷它是否會對廣播和電視收訊造成干擾；如果確實如此，我們建議您嘗試以下列一種或多種方法來排除干擾：

- 重新調整天線的接收方向或重新放置接收天線。
- 增加設備與接收器的距離。
- 將設備連接至不同的插座，使設備與接收器連接在不同的電路上。
- 請向經銷商或有經驗的無線電／電視技術人員查詢，以獲得幫助。

CE Mark Notice

This device complies with the requirements of the European Directive 1999/5/EC.

New Zealand Telecom Warnings

General

"The grant of a Telepermit for any item of terminal equipment indicates only that Telecom has accepted that the item complies with minimum conditions for connection to its network. It indicates no endorsement of the product by Telecom, nor does it provide any sort of warranty. Above all, it provides no assurance that any item will work correctly in all respects with another item of Telepermitted equipment of a different make or model, nor does it imply that any product is compatible with all of Telecom's network services."

"This equipment does not fully meet Telecom impedance requirements. Performance limitations may occur when used in conjunction with some parts of the network. Telecom will accept no responsibility should difficulties arise in such circumstances."

"This equipment shall not be set up to make automatic calls to the Telecom '111' Emergence Service."

"If a charge for local calls is unacceptable, the 'Dial' button should NOT be used for local calls. Only the 7-digits of the local number should be dialed from your telephone. DO NOT dial the area code digit or the '0' prefix."

"This equipment may not provide for the effective hand-over of a call to another device connected to the same line."

Important Notice

"Under power failure conditions, this telephone may not operate. Please ensure that a separate telephone, not dependent on local power, is available for emergency use."

"Some parameters required for compliance with Telecom's Telepermit requirements are dependent on the equipment (PC) associated with this device. The associated equipment shall be set to operate within the following limits for compliance with Telecom's Specification:

1. There shall be no more than 10 call attempts to the same number within any 30-minute period for any single manual call initiation, and the equipment shall go on-hook for a period of not less than 30 seconds between the end of one attempt and the beginning of the next attempt.
2. Where automatic calls are made to different numbers, the equipment shall go on-line for a period of not less than 5 seconds between the end of one attempt and the beginning of the next attempt.
3. The equipment shall be set to ensure that calls are answered between 3 and 30 seconds of receipt of ringing."

"All persons using this device for recording telephone conversations shall comply with New Zealand law. This requires that at least one party to the conversation is to be aware that it is being recorded. In addition, the Principles enumerated in the Privacy Act of 1993 shall be complied with in respect to the nature of the personal information collected, the purpose for its collection, how it is used and what is disclosed to any other party."

[Back to Contents Page](#)

[Back to Contents Page](#)

Removing and Replacing Parts: Dell Precision™ Mobile Workstation M40 User's Guide

[Preparing to Work Inside the Computer](#)

[Replacing a Primary Hard Drive](#)

[Removing or Installing Memory Modules](#)

Preparing to Work Inside the Computer

 **NOTE:** If necessary, print these instructions for reference before proceeding.

Before you start to work on the computer, perform the following steps.

NOTICE: Failure to perform the following steps could result in damage to the computer.

1. Save any work in progress and close all open application programs.
2. Turn off the computer and any attached devices.

 **NOTE:** Make sure that the computer is turned off and not in hibernate mode. If you cannot shut down the computer using the computer operating system, press the power button until the computer turns off.

3. If the computer is docked, undock the computer.

Disconnect the computer and any attached devices from their electrical outlets to reduce the potential for personal injury or shock. Also disconnect any telephone or telecommunications lines from the computer.

NOTICE: To avoid damaging the system board, remove the power cable, the battery, and the second battery (if installed) before you service the computer.

4. Remove the power cable.
5. Disconnect all other external cables from the computer.
6. Remove any installed [PC Cards](#).

NOTICE: Make sure that the work surface is clean to prevent scratching the computer cover.

7. Remove any installed [batteries](#).
8. Ground yourself by touching the unpainted metal surface of the input/output (I/O) panel on the back of the computer.

While you work, periodically touch the I/O panel to dissipate any static electricity that might harm components.

Replacing a Primary Hard Drive

NOTICE: To prevent data loss, turn off your computer before you remove the hard drive. Do not remove the hard drive if the computer is in suspend mode or if the  light is on. Removing the drive under these conditions will lead to loss of data.

1. Complete the tasks as described in "[Preparing to Work Inside the Computer](#)."
2. Close the display and turn the computer over.

 **CAUTION:** The primary hard drive may be hot to the touch under extreme environmental conditions. If the drive is hot, allow it to cool before you replace it.

3. Remove the drive. Use a small Phillips-head screwdriver to remove the drive door screw. Save the screw for use later in this procedure.

When the hard drive is not in the computer, protect the drive from exposure to static electricity. See "[Protecting Against Electrostatic Discharge](#)" for more information.

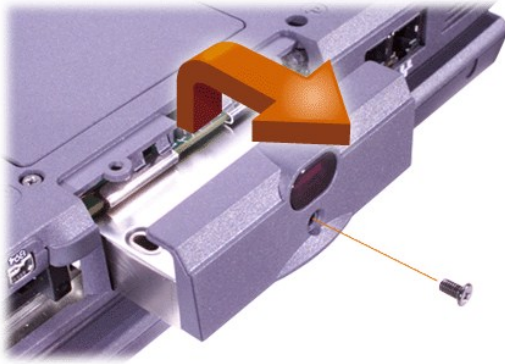

4. Remove the new hard drive from its packaging.

Save the original packaging to use when you store or ship the hard drive.

NOTICE: If the drive does not slide in easily, pull it out and try again. To avoid damage, do not force the drive into the bay.

5. Gently push the new hard drive into the drive bay until the drive door is flush with the computer case.

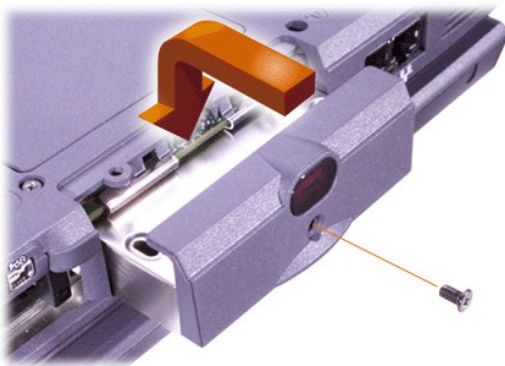

6. Push down on the drive door until it snaps into place.
7. Replace the screw you removed in step 3. Be careful not to over tighten the screw.

If you have installed a new hard drive, follow the directions that came with the drive to partition and logically format the drive.

NOTICE: Hard drives are extremely fragile and must be handled carefully to avoid damage. Follow these guidelines:

- 1 The primary hard drive is installed in a metal carrier to protect the drive and make installation easier. When you remove and install hard drives, handle the drive carrier, not the drive itself.
- 1 Never press down on the top of the drive.
- 1 Do not bump or jar the drive.

Removing or Installing Memory Modules

NOTICE: Your computer only supports 100-megahertz (MHz) synchronous dynamic random-access memory (SDRAM) modules. It does not support extended-data out (EDO) memory modules.

NOTICE: Do not install memory modules while the computer is in any power management modes, such as standby mode.

NOTICE: Ground yourself by touching an unpainted metal surface of a connector on the back of the computer. While you work, periodically touch the connector to dissipate any static electricity that might harm internal components.

To remove or install memory modules, perform the following steps:

1. Complete the tasks as described in "[Preparing to Work Inside the Computer.](#)"

2. Close the display, and turn the computer upside down.
3. Remove the screw from the memory module cover (located next to the icon labeled "K/M"), and remove the memory module cover.

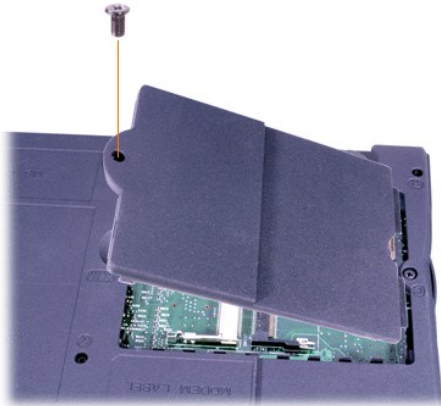

4. If you are replacing a memory module, remove the existing module.
Carefully spread apart the inner metal tabs of the memory module socket, and then lift the memory module away from the socket.



5. Ground yourself and unpack the new memory module from the upgrade kit.
6. If you need to install memory modules in two sockets, install a memory module in the socket labeled "JDIM 1" ("DIMM A") *before* you install a module in the socket labeled "JDIM 2" ("DIMM B").

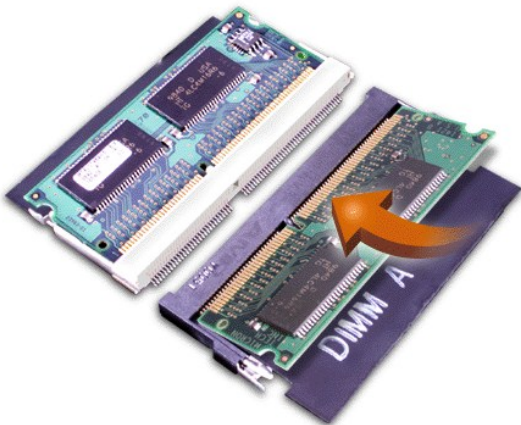

If you have only one memory module, install it in the "JDIM 1" ("DIMM A") socket.

Memory modules are *keyed*, or designed to fit into their sockets in only one direction. The slots on the system board are notched so that the memory module can be firmly seated only one way.

7. If you do not hear a click as each end of the memory module snaps into the metal tabs, remove the memory module and reinstall it.

NOTICE: If the memory module cover does not fit or is difficult to close after installation, you may have installed the memory module improperly or into the wrong slots. Remove the memory module and reinstall it. Do not force the memory module cover to close because you may damage your computer.

8. Replace the memory module cover. Be careful not to over tighten the screw.

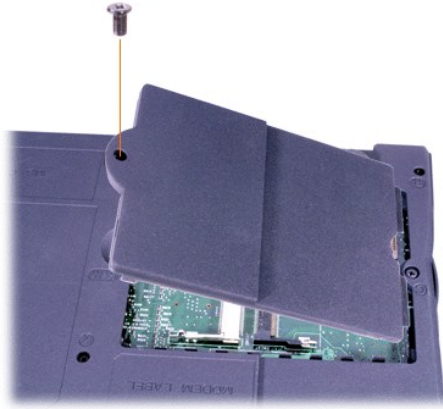

9. Reconnect your computer and devices to their electrical outlets and turn them on.

As the computer boots, it detects the presence of additional memory and automatically updates the system configuration information. Verify that the correct memory total is displayed. If necessary, repeat steps 1 through 8 until the memory total is correct.

[Back to Contents Page](#)

[Back to Contents Page](#)

Passwords and Security: Dell Precision™ Mobile Workstation M40 User's Guide

[About Passwords](#)

[Using a Hard Drive Password](#)

[Using a Primary Password](#)

[Assigning an Asset Tag](#)

[Using an Administrator Password](#)

[Using a Security Cable Slot](#)

About Passwords

A primary password prevents unauthorized access to the computer at start-up. An administrator password can be used in place of the primary password. A hard drive password helps prevent the unauthorized access of data on the drive, even when the device is placed into another computer.



NOTE: All three passwords are disabled when you receive your computer. You need to assign those passwords if you require password security for your computer. Some companies may assign any or all of these passwords before distributing the computer.

NOTICE: The password features provide a high level of security for the data in your computer or hard drive. However, they are not foolproof. If your data requires more security, you should obtain and use additional forms of protection, such as data encryption programs or PC Cards with encryption features.

If you forget any of your passwords, [call Dell](#). For your protection, Dell's technical support staff will ask you for proof of your identity to make sure that an unauthorized person is not trying to use the computer.

Using a Primary Password

The primary password allows you to protect the computer from unauthorized access.

After assigning a primary password, you must enter it each time you turn on your computer. The following message appears each time you turn on the computer:

```
Please type in the primary or administrator password and press <Enter>.
```

To continue, enter your password (maximum eight characters).



NOTE: If no password is entered within 2 minutes, the computer returns to its previous state.

If you have assigned an administrator password, you can use it instead of the primary password. The computer does not specifically prompt you for the administrator password.

NOTICE: If you disable the administrator password, the primary password is also disabled.

Using an Administrator Password

The administrator password is designed to give system administrators or service technicians in large companies access to computers for repair or reconfiguration. The administrators or technicians can assign identical administrator passwords to groups of computers as they are unpacked and configured, leaving the primary password free to be assigned by the user.

When you set an administrator password, the **Configure Setup** option becomes available in the [system setup program](#). The **Configure Setup** option allows you to restrict access to the system setup program in the same way a system password restricts access to the system.

The administrator password can be used in place of the primary password. Whenever you are prompted to enter the primary password, you can enter the administrator password instead.



NOTE: The administrator password provides access to the system, but it does not provide access to the hard drive when it is protected by a password.

If you forget the primary password and do not have an administrator password assigned, or if you have both a primary and an administrator password assigned but forget them both, [call Dell](#).

NOTICE: If you disable the administrator password, the primary password is also disabled.

Using a Hard Drive Password

The hard drive password helps protect the data on your hard drive from unauthorized access. You can also assign a password for the modular

hard drive (if one is being used) that can be the same as or different from the password for the primary hard drive.

 **NOTE:** Only hard drives purchased from Dell for use with the Dell Precision Mobile Workstation M40 computer support the hard drive password option.

After assigning a hard drive password, you must enter it each time you turn on the computer and each time you resume normal operation from suspend mode or standby mode.

If the hard drive password is enabled, the following message appears each time you turn on the computer:

```
Please type in the hard-disk drive password and press <Enter>.
```

To continue, enter your password (maximum eight characters). Press <Esc> to return the computer to its previous state—suspend or standby mode.

 **NOTE:** If no password is entered within 2 minutes, the computer returns to its previous state.

If you enter the wrong password, the following message appears:

```
Invalid password  
[Press Enter to retry]
```

If the correct password is not entered in three attempts, the computer tries to boot from another bootable device if the **Boot First Device** option in the [system setup program](#) is set to allow it. If the **Boot First Device** option is not set to allow booting from another device, the computer returns to the state it was in when you turned it on—standby mode.

 **NOTES:** If the hard drive password, the modular hard drive password, and the primary password are the same, you are prompted only for the primary password. If the hard drive password is different from the primary password, you are prompted for both. Two different passwords provide greater security.

The administrator password provides access to the computer, but it does not provide access to a hard drive that is protected by a password.

Assigning an Asset Tag

The Asset Tag utility allows you to enter an asset tag number that you or your company assigns to the computer. The default system setup screens do not show the asset tag number unless you enter one by using this utility.

You can also use the Asset Tag utility to enter an owner tag that appears in the system log-on screen and with the primary password prompt.

Viewing Existing Asset Tag and Service Numbers

1. Boot the computer from a bootable floppy disk or CD.
2. Type `cd c:\Dell\Util` and press <Enter>.
3. Type `asset` and press <Enter>.

Assigning an Asset Tag Number

An asset tag number can have up to ten characters; any combination of characters excluding spaces is valid.

1. Boot the computer from a bootable floppy disk or CD.
2. Type `cd c:\Dell\Util` and press <Enter>.
3. Type `asset` and a space followed by the new number, and press <Enter>.

For example, type the following command line and press <Enter>:

```
asset 1234$ABCD&
```

4. When the system prompts you to verify the asset tag number, type `y` and press <Enter>.

The system displays the new or modified asset tag number and the service tag number.

Deleting an Asset Tag Number

1. Boot the computer from a bootable floppy disk or CD.
2. Type `cd c:\Dell\Util` and press <Enter>.
3. Type `asset /d` and press <Enter>.

Assigning an Owner Tag

An owner tag can have up to 48 characters; any combination of letters, numbers, and spaces is valid.

1. Boot the computer from a bootable floppy disk or CD.
2. Type `cd c:\Dell\Util` and press <Enter>.
3. Type `asset /o` and a space followed by the new owner tag, and press <Enter>.

For example, type the following command line and press <Enter>:

```
asset /o ABC Company
```

4. When the computer prompts you to verify the owner tag, type `y` and press <Enter>.

The computer displays the new owner tag.

Deleting an Owner Tag

1. Boot the computer from a bootable floppy disk or CD.
2. Type `cd c:\Dell\Util` and press <Enter>.
3. Type `asset /o /d` and press <Enter>.

 **NOTE:** For security, you cannot set, change, or delete the owner tag if the primary or administrator passwords are set.

To use one of the following command-line options, open an MS-DOS® prompt, type `asset` and a space followed by the option, and then press <Enter>.

Asset Tag Utility Command-Line Options

| Asset Tag Option | Description |
|---------------------|--|
| <code>/d</code> | Deletes the asset tag number |
| <code>/o tag</code> | Specifies a new owner tag |
| <code>/o /d</code> | Deletes the owner tag |
| <code>/?</code> | Displays the Asset Tag utility help screen |

Using the Security Cable Slot

To prevent unauthorized removal of the computer, you can use a security cable to attach the computer to an immovable object. Your computer has two security cable slots, located on the both sides of the computer.

1. Loop the cable around an immovable object.
2. Insert a locking device into the security cable slot, and lock the device. Instructions for installing this kind of antitheft device are usually included with the device.



Antitheft devices for mobile workstation computers usually include a segment of metal-stranded cable with an attached locking device and associated key.

 **NOTE:** Before purchasing an antitheft device, make sure that it will work with a security cable slot.

[Back to Contents Page](#)

[Back to Contents Page](#)

Using the System Setup Program: Dell Precision™ Mobile Workstation M40 User's Guide

- [Overview](#)
- [Changing Printer Modes](#)
- [Entering and Exiting the System Setup Program](#)
- [Changing COM Ports](#)
- [The System Setup Screens](#)
- [Enabling the IR Sensor](#)
- [Changing the Boot Sequence](#)

 **NOTE:** This section provides general information on using the system setup program. For detailed information on options and settings, enter the system setup program and navigate through the screens, or visit the Dell support website at <http://support.dell.com>.

Overview

 **NOTE:** ACPI operating systems, such as Microsoft® Windows® 2000, automatically configures most of the setup options available in the system setup program, and override options entered through the system setup program. One exception is the **External Hot Key** option, which you can disable or enable only through the system setup program. For more information on configuring features for these operating systems, see your Microsoft Windows Help.

You can use the system setup program as follows:

- 1 To set or change user-selectable features—for example, your password or power management features
- 1 To verify information about your computer's current configuration, such as the amount of system memory

For some setup options, you must reboot the computer before any changes take effect. Changes for other options take effect immediately. The Help text in the upper-right corner of system setup screens tells you if the computer must be rebooted.

After you set up your computer, run the system setup program to familiarize yourself with your system configuration information and optional settings. Dell recommends that you write down the information for future reference.

Entering and Exiting the System Setup Program

| Action | Computer or External Keyboard |
|---------------------------------|--|
| Enter the system setup program. | <F2> when prompted during the system boot routine. If you do not enter the system setup program when prompted, wait until the computer finishes the boot routine, restart the computer, and then begin again. |
| Exit the system setup program. | <Esc> If you change the setting of an option that requires rebooting to take effect, exit the operating system <i>before</i> rebooting. (The Help text in the upper-right corner of system setup screens tells you if the computer must be rebooted.) |

 **NOTE:** If the system setup program is running when the computer enters standby mode, the computer exits the system setup program and then activates standby mode.

The System Setup Screens

The system setup screens display the current setup and configuration information and optional settings for your computer. Information on the screens is organized in five boxed areas:

- 1 **Title**

The box at the top of each screen lists the page number, system name, and version number of the basic input/output system (BIOS).
- 1 **Options**

The box on the left half of each screen lists options that define the installed hardware in your computer and the power conservation and security features for your computer.

Fields next to the options contain settings or values. You can change those values that appear bright on the screen. Options or values that you cannot change (because they are determined or calculated by the computer) appear less bright.

1 Help

The box on the upper-right half of each screen displays help information for the option with a currently highlighted field.

1 Computer data

The box in the lower-right corner of each screen displays information about your computer.

1 Key functions

The line of boxes across the bottom of each screen lists keys and their functions within the system setup program.

Changing the Boot Sequence

To change the computer's boot sequence, change the device settings in the **Boot First Device**, **Boot Second Device**, or **Boot Third Device** options.

| Boot Sequence Option | Description |
|----------------------|---|
| Boot First Device | Tells the computer where to look first for the software it needs to start the operating system |
| Boot Second Device | Tells the computer where to look if it cannot find the software it needs to start the operating system on the drive identified in Boot First Device |
| Boot Third Device | Tells the computer where to look if it cannot find the software it needs to start the operating system on the drive identified in Boot First Device or Boot Second Device |

 **NOTE:** You can only boot from a CD, CD-RW, or DVD drive installed as a fixed optical drive. You cannot boot from one of these modules installed in the modular bay.

For a change in the boot sequence options to take effect, you must reboot your computer.

The term *boot* refers to the computer's start-up procedure. When you turn on the computer, it "bootstraps" itself into an operational state by loading into memory a small program, which in turn loads the necessary operating system. The *boot sequence* tells the computer where to look to find the software needed to start the operating system.

Changing Printer Modes

Set the **Parallel Mode** option according to the type of printer or device connected to the parallel port. To determine the correct mode to use, see the documentation that came with the device.

Setting **Parallel Mode** to **Disabled** disables the parallel port and its assigned LPT address, freeing its interrupt for another device to use.

Changing COM Ports

Serial Port allows you to map the address of the serial port, or to disable the serial port and its assigned COM address, freeing that interrupt for another device to use.

Enabling the IR Sensor

1. Set the **Infrared Data Port** option to a COM setting (**COM3** is recommended).
 2. Set the **Infrared Mode** option to either **Fast IR** or **Slow IR**.
-

[Back to Contents Page](#)

[Back to Contents Page](#)

Finding Solutions: Dell Precision™ Mobile Workstation M40 User's Guide

- [Overview](#)
- [Recover From a Program That Is Not Responding](#)
- [Restart a Computer That Is Not Responding](#)
- [Wet Computer](#)
- [Dropped or Damaged Computer](#)
- [No Power at All](#)
- [No Power, Using AC Adapter](#)
- [No Power, Using Battery](#)
- [Only Partial Power](#)
- [Floppy Drive Problems](#)
- [CD, CD-RW, DVD Drive Problems](#)
- [Hard Drive Problems](#)
- [Hardware Conflicts](#)
- [Incorrect Computer Memory Amount](#)
- [PC Card Problems](#)
- [Modem, Fax, and Internet Connection Problems](#)
- [No Image Appears on Display](#)
- [No Image Appears on External Monitor](#)
- [No Image Appears on TV](#)
- [Sound and Speaker Problems](#)
- [DualPoint Device, Touch Pad, or Mouse](#)
- [Caps Lock, Num Lock, and Scroll Lock Lights Don't Light Up](#)
- [External Keyboard Doesn't Work](#)
- [Devices Attached to Serial or Parallel Ports Don't Work](#)
- [Parallel Port Printer Doesn't Work](#)
- [Software Solutions](#)

Overview



Before you call Dell for technical assistance, complete the following tasks to help you resolve some computer problems:



1. Read the safety instructions in your *System Information* guide and "[What You Need to Know](#)."
2. Run the [Dell Diagnostics](#) to help you detect a problem quickly.
3. Perform the appropriate procedure for the component or equipment that is malfunctioning. Click a [topic from the menu](#) at the top of this page for instructions.





 **NOTE:** When you see the question "Is the problem resolved?" in a problem-solving procedure, perform the operation that caused the problem to see if the problem still occurs.







 **CAUTION:** To help prevent possible damage to the system board, wait 5 seconds after turning off the computer before you disconnect a device or remove a memory module.



NOTICE: Only access the inside of your computer when you are installing memory modules.

| Problem | Procedure |
|---|--|
| Recover From a Program That Is Not Responding | <ol style="list-style-type: none"> 1. Press <Ctrl><Alt>. 2. If necessary, click Task Manager. 3. Select the program that is no longer responding. 4. Click End Task. |
| Restart a Computer That Is Not Responding | <ol style="list-style-type: none"> 1. Press and hold the power button until the computer turns off. 2. To turn on the computer, press the power button. <p>Check Disk (or ScanDisk), a program that checks for and repairs errors on the hard drive, may run during the boot process. Microsoft Windows loads and runs after the scan completes.</p> |
| Wet Computer  Spills, splashes, and excessive humidity can cause moisture damage to the computer. | <p> CAUTION: Perform step 1 only after you are certain that it is safe to do so. If the computer is connected to an electrical outlet, Dell recommends turning off AC power at the circuit breaker before attempting to remove the power cables from the electrical outlet. Use the utmost caution when removing wet cables from live power.</p> <ol style="list-style-type: none"> 1. Turn off the computer and disconnect it from the AC adapter. Then disconnect the AC adapter from the electrical outlet. Turn off any attached peripherals and disconnect them from their power sources and then from |

| | |
|--|---|
| | <p>the computer.</p> <ol style="list-style-type: none"> Ground yourself by touching one of the metal connectors on the back of the computer. Remove any installed batteries. <p>Wipe off each battery and store it in a safe place to dry.</p> <ol style="list-style-type: none"> If the modular bay is wet, remove the device from the bay. If the PC Card slot is wet, remove any PC Cards. Put the device and cards in a safe place to dry. Remove the hard drive. Remove the memory module(s). Open the display, and place the computer across two books or similar props to let air circulate all around it. Let the computer dry for at least 24 hours. <p>Place the computer in a dry area at room temperature. Do not use artificial means to speed up the drying process.</p> <p>⚠ CAUTION: Before continuing with this procedure, verify that the computer is thoroughly dry.</p> <ol style="list-style-type: none"> Ground yourself by touching one of the unpainted metal connectors on the I/O panel. Replace the memory module(s). Replace the memory module cover. Reinstall the hard drive. Reinstall the modular bay and PC Cards that you removed. Replace any batteries that you removed. Reconnect the computer and peripherals to an electrical outlet and turn them on. Does the computer work properly? <p>Yes. The problem is resolved.</p> <p>No. If the computer is able to boot, run the Dell Diagnostics to identify computer damage. If the computer is unable to boot, see "No Power at All." If you cannot identify the damaged component(s), call Dell for technical assistance.</p> |
| Dropped or Damaged Computer | <ol style="list-style-type: none"> Save and close any open files, exit any open application programs, and shut down the computer. Disconnect the AC adapter from the electrical outlet and disconnect the AC adapter from the computer. Turn off any attached devices and disconnect them from the electrical outlet and then from the computer. Ground yourself by touching one of the metal connectors on the back of the computer. Remove any installed batteries or other devices from the modular bay. Remove the hard drive. Remove the memory module cover and the memory module(s). Reinstall the memory modules, making sure to seat them properly. Replace the memory module cover. Reinstall the hard drive. Verify that any installed PC Cards are properly seated in the PC Card connectors. Reinstall the battery or other device(s) removed from the modular bay. Verify that the device(s) is seated properly. Reconnect the computer and peripherals to the electrical outlet and turn them on. Run the Dell Diagnostics to verify that the computer is operating properly. If the computer does not operate properly, fill out the Diagnostics Checklist. Then call Dell for technical assistance. |
| <p>No Power at All</p> <p> If you don't have any power, none of the lights on the keyboard light up and you don't hear sounds from any drives. See also "Only Partial Power."</p> | <p>Fill out the Diagnostics Checklist as you perform the following steps:</p> <ol style="list-style-type: none"> Connect the AC adapter to the computer and to an electrical outlet. Remove all devices, including internal devices such as the floppy drive, hard drive, and battery. Turn on the computer. Does the computer turn on properly? <p>Yes. The problem is resolved.</p> <p>No. Go to Step 5.</p> <ol style="list-style-type: none"> Turn off the computer. Does the  light appear? <p>Yes. Go to step 6.</p> <p>No. Go to step 7.</p> <ol style="list-style-type: none"> Remove any installed batteries and disconnect the AC adapter. Then reinstall the batteries, reconnect the AC adapter, and turn on the computer. Does the  light appear? <p>Yes. Go to step 8.</p> <p>No. Go to step 7.</p> |

| | |
|---|--|
| | <p>7. Turn off the computer, wait a few seconds, and then turn on the computer again. Does the  light appear?</p> <p>Yes. Your computer is receiving power. Go to step 8.</p> <p>No. Your computer is not receiving power. Go to step 9.</p> <p>8. Does the computer boot successfully?</p> <p>Yes. The problem is resolved.</p> <p>No. Go to step 9.</p> <p>9. Remove and reinstall any batteries, and check the AC adapter connection. Does the  light appear?</p> <p>Yes. The problem is resolved.</p> <p>No. If the computer is powered by the AC adapter, see "No Power. Using AC Adapter." If the computer is using battery power, see "No Power. Using Battery."</p> |
| <p>No Power, Using AC Adapter</p> | <p>Basic Checks:</p> <ul style="list-style-type: none"> 1 Test the electrical outlet: Ensure that the electrical outlet is working by testing it with another device such as a lamp. 1 Connect the AC adapter directly to an electrical outlet: Bypass power protection devices, power strips, and extension cords to verify that the computer turns on. 1 Check for interference: High-voltage electrical appliances on the same circuit or operating in close proximity to the computer can cause interference. Extension cords or too many devices on a power strip or multiple power strips connected to an electrical outlet can cause problems. <p>Fill out the Diagnostics Checklist as you perform the following steps:</p> <ol style="list-style-type: none"> 1. Turn off the computer and devices and disconnect them from the electrical outlet. If you are using a surge protector, remove it. 2. Make sure the AC adapter is connected to the computer, and then verify that the power cable is firmly attached to the AC adapter and to the electrical outlet. 3. Does the light on top of the AC adapter light up? <p>Yes. Go to step 4.</p> <p>No. The AC adapter may be defective. Go to step 5.</p> <ol style="list-style-type: none"> 4. Turn on the computer. Does the  light appear? <p>Yes. The problem is resolved.</p> <p>No. Go to step 5.</p> <ol style="list-style-type: none"> 5. Call Dell for technical assistance. |
| <p>No Power, Using Battery</p> <p> If an AC adapter is not connected to your computer, the computer runs on battery power. If the computer does not turn on when a battery is installed, the battery's charge may be depleted.</p> | <p>Fill out the Diagnostics Checklist as you perform the following steps:</p> <ol style="list-style-type: none"> 1. Turn off the computer and devices. Disconnect the devices from the electrical outlet. 2. Remove and then reinstall each battery in its bay. 3. Press the power button. Does the computer turn on? <p>Allow 1 minute for the computer to initialize its components before checking for signs of power.</p> <p>Yes. The battery was not seated properly. The problem is resolved.</p> <p>No. Use the AC adapter to connect your computer to an electrical outlet. If the computer operates normally when using AC power, go to step 4. If the computer does not boot when using the AC adapter, see "No Power. Using AC Adapter."</p> <ol style="list-style-type: none"> 4. Use the AC adapter to charge the battery. 5. Does the  light remain constantly lit (not blinking), indicating that the battery is charging? <p>Yes. Go to step 6.</p> <p>No. You may have a defective battery. Call Dell for technical assistance.</p> <ol style="list-style-type: none"> 6. Press the power button. Does computer turn on? <p>Yes. You needed to charge the battery. The problem is resolved.</p> |

| | |
|---|--|
| | <p>No. Call Dell for technical assistance.</p> |
| <p>Only Partial Power</p> <p> If the  light shows that your computer is receiving power, but the display remains blank, part of your computer is probably not receiving power. See also "No Power at All."</p> | <ol style="list-style-type: none"> 1. Turn off the computer and devices and disconnect them from the electrical outlet. Disconnect any attached devices from the computer. 2. Make sure that the AC adapter is connected to the computer and to an electrical outlet, or confirm that a fully charged battery is properly seated in the modular bay. 3. Turn on the computer. Is the display on? <p>Allow 1 minute for the computer to initialize its components before checking for signs of power.</p> <p>Yes. The entire computer is receiving power; the problem is resolved.</p> <p>No. Adjust the brightness of the display. If the display still does not show an image, call Dell for technical assistance.</p> |
| <p>Floppy Drive Problems</p> <p> During the power-on self-test (POST), the computer checks the floppy drive, comparing its characteristics with the system configuration information. (The  light blinks as the computer performs this check on a floppy drive.)</p> | <p>Basic Checks:</p> <ol style="list-style-type: none"> 1 If you hear an unfamiliar scraping or grinding sound when a drive is accessed, make sure the sound is not caused by the application program that is running. The sound could be caused by a hardware malfunction. See "Help Overview" for instructions on obtaining technical assistance from Dell. 1 When you turn on the computer, you can hear floppy or hard drive activity during the boot routine. If your computer does not boot, call Dell for technical assistance. (See "Help Overview" for instructions.) Otherwise, see the "Dell Diagnostics." 1 Test this indicator by inserting a floppy disk into the drive, typing <code>dir a:</code> at an MS-DOS® prompt, and pressing <Enter>. 1 Ensure that the floppy disk is not write-protected if you are trying to copy data to it. 1 Run the Diskette tests as described in "Dell Diagnostics." 1 Try a different floppy disk in the drive. If the new floppy disk works, the original one may be defective. 1 Check the settings on the Page One submenu of the system setup program. 1 Clean the drive using a commercially available cleaning kit. <p>NOTICE: Do not attempt to clean drive heads with a swab. You may accidentally misalign the heads, rendering the drive inoperable.</p> <p>If the problem still exists after you complete the basic checks, fill out the Diagnostics Checklist as you perform the following steps:</p> <ol style="list-style-type: none"> 1. Save and close any open files, exit any open application programs, and shut down the computer. 2. Remove the floppy drive from the modular bay. 3. Reinstall the floppy drive. 4. Reboot the computer. Does the  light blink during the boot routine? <p>Yes. Go to step 6.</p> <p>No. Go to step 5.</p> <ol style="list-style-type: none"> 5. Remove and reinsert the floppy drive. Reboot the computer. Does the  light appear during the boot routine? <p>Yes. Go to step 6.</p> <p>No. Go to step 9.</p> <ol style="list-style-type: none"> 6. Does the computer display a drive error message? <p>Yes. See "Understanding Error Messages" for an explanation of the message, and then go to step 7.</p> <p>No. Go to step 9.</p> <ol style="list-style-type: none"> 7. Insert a bootable 1.44-megabyte (MB) floppy disk into the floppy drive and reboot the computer. 8. Does the  light blink during the boot routine, and does the drive boot the operating system? <p>Yes. The floppy drive problem has probably been resolved. If you continue to experience trouble, call Dell for technical assistance.</p> <p>No. Go to step 9.</p> <ol style="list-style-type: none"> 9. Call Dell for technical assistance. |
| <p>CD, CD-RW, DVD Drive Problems</p> | <p>Basic Checks:</p> <ol style="list-style-type: none"> 1 If you hear an unfamiliar scraping or grinding sound when a drive is accessed: |

 During POST, the computer checks the drive, comparing its characteristics with the system configuration information. The  light blinks as the computer performs this check.

Inconsistencies in the manufacturing of CD media may cause some higher-speed CD drives to vibrate more than others. Such vibration and associated noise do not indicate a defect in the drive or the CD.

- o Make sure the sound is not caused by the application program that is running. The sound could be caused by a hardware malfunction. See "[Help Overview](#)" for instructions on obtaining technical assistance from Dell.
- o Verify that the disc is fully seated on the drive spindle.
- 1 When you turn on the computer, you can hear floppy or hard drive activity during the boot routine. If your computer does not boot, [call Dell](#) for technical assistance. Otherwise, see the "[Dell Diagnostics](#)."
- 1 Test the drive indicator by typing `dir x:` at an MS-DOS prompt, where *x* is the drive letter, and pressing <Enter>.
- 1 Verify that the drive is recognized by the computer (*in Windows 2000*, double-click the **My Computer** icon on your desktop). Most of the common boot sector viruses cause the drive to "disappear." Use virus-scanning software (if Dell installed the operating system on your computer, you should already have virus-scanning software) to check for and remove any viruses.
- 1 Clean the disc using a commercially available cleaning kit.
- 1 Clean the drive using a commercially available cleaning kit.
- 1 Try another CD or DVD.

 **NOTE:** Because of different conventions currently used in the industry, not all DVD titles work in all DVD drives.

- 1 Run the **IDE Devices** tests as described in "[Dell Diagnostics](#)."
- 1 Turn off the computer and remove the drive from the modular bay. Replace the drive and turn on the computer.

If the CD, CD-RW, or DVD drive button doesn't eject the tray, or if you have a power failure:

1. Make sure the computer is off.
2. Straighten a paper clip and insert one end into the eject hole at the front of the drive; push firmly until the tray is partially ejected.
3. Pull the tray out the rest of the way.

If the problem still exists after you complete the basic checks, fill out the [Diagnostics Checklist](#) as you perform the following steps:

1. Save and close any open files, exit any open application programs, and shut down the computer.
2. If the drive is installed in the modular bay, [remove the drive](#). If the drive is a fixed optical drive, go to step 6.
3. Reinstall the drive.
4. Reboot the computer. Does the  light blink during the boot routine?

Yes. Go to step 6.

No. Go to step 5.

5. Remove and reinsert the drive. Reboot the computer. Does the  light blink during the boot routine?

Yes. Go to step 6.

No. Go to step 10.

6. Remove the [hard drive](#) and boot the computer from a bootable CD. Does the  light blink?

Yes. Go to step 7.

No. Go to step 10.

7. Reinstall the hard drive. Then open the **Control Panel**, double-click the **System** icon, click the **Hardware** tab, and click the **Device Manager** button. Is the appropriate driver installed?

Yes. Go to step 8.

No. Load the driver, and return to step 1 to begin this procedure again. (To load the driver, use the *Drivers and Utilities* CD you received with your Dell computer.)

8. Insert a bootable floppy disk into drive A and reboot the computer.
9. Type `x:` (where *x* is the drive) and press <Enter>. Then type `dir` and press <Enter>. Does MS-DOS display the root directory contents for the drive?

Yes. The problem is resolved.

No. Go to step 10.



10. Insert your *Drivers and Utilities* CD into the drive and reboot the computer. Then run the **IDE Devices** device group. Does your drive pass all the tests?

Yes. Return to step 1 and perform this troubleshooting procedure again. If you continue to experience trouble, [call Dell](#) for technical assistance.

No. Go to step 11.

11. Call Dell for technical assistance.

Hard Drive Problems

 During POST, the computer checks the hard drive, comparing its characteristics with the system configuration information. (The  light blinks as the computer performs this check.)

Basic Checks:

- 1 If you hear an unfamiliar scraping or grinding sound when a drive is accessed, make sure the sound is not caused by the application program that is running. The sound could be caused by a hardware malfunction. See "[Help Overview](#)" for instructions on obtaining technical assistance from Dell.
- 1 When you turn on the computer, you can hear floppy or hard drive activity during the boot routine. If your computer does not boot, call Dell for technical assistance. (See "[Help Overview](#)" for instructions.) Otherwise, see the "[Dell Diagnostics](#)."
- 1 Test the drive indicator by typing `dir x:` at an MS-DOS prompt, where `x` is the drive letter, and pressing <Enter>.
- 1 Run the Check Disk (or ScanDisk) utility. To do this, double-click the **My Computer** icon (or click the **Start** button, and then click **My Computer**), right-click the hard drive, click **Properties**, click the **Tools** tab, click **Check Now**, and click **Start**.
- 1 Run the **IDE Devices** device group as described in "[Dell Diagnostics](#)."

If the problem still exists after you complete the basic checks, fill out the [Diagnostics Checklist](#) as you perform the following steps:

1. Shut down the computer.
2. Reboot the computer. Does the  light blink during the boot routine, and does the drive boot the operating system?

Yes. If a message appears on the display, see "[Understanding Error Messages](#)," for an explanation of the message and possible corrective actions. Then go to step 7.

No. Go to step 3.

3. Insert a bootable floppy disk into drive A and reboot the computer.
4. Type `c:` and press <Enter>. Then type `dir` and press <Enter>. Does MS-DOS display the root directory contents for drive C?

Yes. Go to step 6.

No. Go to step 5.

5. If your hard drive has more than one logical drive, type `x:` (where `x` is the CD-ROM or DVD drive) and press <Enter>. Then type `dir` and press <Enter>. Does MS-DOS display the root directory contents for the CD-ROM and DVD drive?

Yes. You may have a corrupted boot sector or file allocation table (FAT) on drive C. Go to step 9.

No. Go to step 8.

6. Rename your **autoexec.bat** and **config.sys** files, remove the operating system floppy disk from drive A, and reboot the computer. Does the operating system load now?

Yes. You have an error in your **autoexec.bat** or **config.sys** file. Use a text editor to examine the contents of these files and locate the error. For information on the correct syntax for commands in these files, see the documentation that accompanied your operating system.

No. Go to step 7.

7. Insert your *ResourceCD* and reboot the computer. Then run the **IDE Devices** device group. Does your drive pass all the tests?

Yes. Go to step 8.

No. Go to step 9.

8. Replace your *ResourceCD* with the operating system CD, and reboot the computer. Does the operating system load now?

Yes. The hard drive may contain a corrupted operating system or it may have bad sectors. Reinstall the operating system as described in the documentation that came with it. If reinstalling the operating system does not correct the problem, go to step 9.

No. Go to step 9.

9. [Call Dell](#) for technical assistance.

Hardware Conflicts



Hardware conflicts occur if the device is detected by the operating system but is configured incorrectly.

Symptoms:

- 1 System hangs or locks up, particularly while using a device.
- 1 (Memory) parity errors on parity-enabled systems.
- 1 Noise or other problems from sound cards.
- 1 Junk being printed on your printer.
- 1 The mouse pointer hanging and refusing to move, or moving in a stuttering fashion.
- 1 Error messages from Windows, messages about the computer not operating at maximum performance, or the system dropping to "Safe Mode" or "MS-DOS Compatibility Mode".
- 1 Errors and crashes of applications for no apparent reason.

Hardware conflicts occur if the device is detected by the operating system but is configured incorrectly. To check for conflicts, perform the following steps:

1. Open the **Control Panel** (if you are running Windows 2000, click the **Start** button, point to **Settings**, and double-click **Control Panel**).
2. In the **Control Panel**, double-click **System**.
3. Click the **Hardware** tab, and click **Device Manager**.
4. Conflicts are indicated in the **Device Manager** list by a yellow exclamation point (!) beside the conflicting device. A red X beside a device indicates that the device is disabled in the current hardware profile.

View the status of a device by double-clicking the type of device, clicking **Properties**, and clicking the **General** tab.

5. If a hardware conflict exists, the **Device status** area in the **Properties** window shows the conflicting expansion cards or devices.

To resolve conflicts, see your operating system documentation.

Incorrect Computer Memory Amount



During POST, the computer checks the computer's memory, and then writes to and reads from the number of available bytes to ensure proper operation.

Basic Checks:

- 1 If an insufficient memory message appears, save and close any open files and exit any open programs not in use.
- 1 Consider installing additional system memory.
- 1 Run the **System Memory** test as described in "[Dell Diagnostics](#)."
- 1 Reseat the [memory modules](#).
- 1 Restart the computer.

If the problem still exists after you complete the basic checks, fill out the [Diagnostics Checklist](#) as you perform the following steps:

1. Reboot the computer. Does the random-access memory (RAM) count displayed correctly match the actual amount of memory installed in the computer?

Yes. The computer needed to update the memory; the memory check phase is okay now.





No. Go to step 2.
2. Save and close any open files, exit any open programs, and remove any installed batteries.
3. Turn off the computer and disconnect it from the AC adapter. Then disconnect the AC adapter from the electrical outlet. Turn off any attached devices, and disconnect them from their power sources and then from the computer.
4. Ground yourself by touching one of the metal connectors on the back of the computer.
5. Turn the computer over and remove the [memory module cover](#) and the memory modules.
6. Install the new memory module(s).
7. Replace the memory module cover.
8. Reboot the computer, and press <F2> when prompted to enter the system setup program.
9. [Call Dell](#) for technical assistance.

PC Card Problems

Basic Checks:

- 1 Ensure that the [PC Card](#) is properly inserted into the connector.
- 1 Ensure that the card is recognized by the Windows operating system:
 1. Double-click the **Unplug or Eject Hardware** icon in the Windows taskbar.
 2. Ensure that the card is listed.

If you still have problems with a Dell-provided PC Card, [call Dell](#) for technical assistance. If you have problems with a

| | |
|---|--|
| | non-Dell-provided PC Card, call the card manufacturer. |
| <p>Modem, Fax, and Internet Connection Problems</p>  If you can connect to your Internet service provider (ISP) and send or receive a fax, your modem is functioning properly. If you are sure that your modem is working properly and you still experience problems connecting to your ISP, contact the ISP technical support department for assistance. | <p>NOTICE: Connect the modem to an analog line only. Using a nonanalog line, such as a digital or private branch exchange (PBX) line, will damage the modem.</p> <p>NOTICE: Do not confuse the modem and network connectors on your computer. Do <i>not</i> plug a telephone line into the network connector.</p> <p>Basic Checks:</p> <ul style="list-style-type: none"> 1 Ensure that you have touch-tone telephone service. 1 If you have call-waiting service, disable call-waiting. Refer to your local telephone directory or call your telephone service provider for information on temporarily disabling call-waiting. 1 If you have voice mail service, you may hear an irregular dial tone when you have messages. Contact your telephone service provider for information on restoring a normal dial tone. 1 If you have any other telephone devices plugged into this line, such as answering machines, dedicated fax machines, or line splitters, bypass them and plug the modem cable directly into the telephone connector on the wall. 1 Reseat the cable connections. 1 Try a different cable; if you are using a cable that is 10 feet or more in length, try a shorter one. 1 Disconnect the cable from the modem and plug it directly into a telephone. Listen for a dial tone. 1 Line noise can cause low connection speeds. If you have persistent problems, try connecting the modem to a different telephone connector. You may also wish to contact your telephone company to report the problem. <p>If you still have problems with a Dell-provided modem, call Dell for technical assistance. If you have problems with a non-Dell-provided modem, call the modem manufacturer.</p> |
| <p>No Image Appears on Display</p>  Extended graphics array (XGA) displays support 1024 x 768 pixels, and super extended graphics array plus (SXGA+) displays support 1400 x 1050 pixels. If your application program uses a higher resolution, you must attach an external video graphics array (VGA) monitor to your computer. | <p>Basic Checks:</p> <ul style="list-style-type: none"> 1 If the display is blank, the computer may be in standby mode. To resume normal operations, press the power button. 1 If the display is blank and the  light is on, the display may have timed out. In this case, press any key on the keyboard or move the mouse to resume normal operation. 1 If the  light is blinking, connect the AC adapter to the computer or replace the battery. 1 Adjust the brightness. 1 If your computer is attached to an external monitor, press <Fn><F8> to switch the video image to the display. <p>If the computer is receiving power, but nothing appears on your display (such as light, text, or graphics) or the display image does not appear as you would expect, fill out the Diagnostics Checklist as you perform the following steps.</p> <ol style="list-style-type: none"> 1. If the computer is running, press any key on the integrated keyboard. Is the full display readable? <ul style="list-style-type: none"> Yes. The computer was in standby mode. The problem is resolved. No. Go to step 2. 2. Is an external monitor connected to the computer? <ul style="list-style-type: none"> Yes. Go to step 3. No. Go to step 4. 3. Press the <Fn><F8> key combination. Is the full display readable? <ul style="list-style-type: none"> Yes. The problem is resolved. No. Go to step 8. 4. Turn off the computer and any attached devices. Disconnect all devices from the computer. 5. Make sure that the AC adapter is firmly connected to the computer and to an electrical outlet, or verify that a fully charged battery is properly seated in its bay. 6. Turn on the computer. Is the display on? <ul style="list-style-type: none"> Allow one minute for the computer to initialize its components. Yes. Go to step 7. No. Go to step 9. 7. Adjust the brightness. Is the full display readable? <ul style="list-style-type: none"> Yes. Go to step 8. No. Go to step 9. 8. Has an error message appeared? |

| | |
|---|---|
| | <p>Yes. See "Understanding Error Messages," to find the message, along with its explanation. If you can't find the message, call Dell for technical assistance.</p> <p>No. If you still have a display problem but the display is not completely blank, run the Video device group in the Dell Diagnostics. Then call Dell for technical assistance.</p> <p>9. Turn off your computer and connect an external monitor to the computer.</p> <p>10. Turn on the computer and the monitor and adjust the monitor's brightness and contrast controls. Is the monitor readable?</p> <p>Yes. The computer's display may be defective. Call Dell for technical assistance.</p> <p>No. The computer's video controller on the system board may be defective. Call Dell for technical assistance.</p> |
| <p>No Image Appears on External Monitor</p> <p> During POST, the computer checks to see if an external monitor is attached to the computer</p> | <p>Basic Checks:</p> <ul style="list-style-type: none"> 1 Press <Fn>< F8> to switch the video image from the display to the external monitor. <p>If the external monitor is blank, the computer may be in standby or hibernate mode. To resume normal operations, press the power button.</p> <ul style="list-style-type: none"> 1 Ensure that the video cable is firmly attached to the video connector on the back of the computer and that the monitor power cable is plugged into a working electrical outlet. 1 Check for damaged or frayed cables and for bent pins on connectors. It is normal on some video cable connectors for pins to appear to be missing. See the monitor documentation. 1 Check the Video Display Device setting in the system setup program. To use an external monitor, this option must be set to CRT Mode or Simul Mode. 1 Adjust brightness and contrast settings. 1 Run the VESA/VGA Interface tests as described in "Dell Diagnostics." 1 Restart the computer. <p>If the problem still exists after you complete the basic checks, fill out the Diagnostics Checklist as you perform the following steps:</p> <p>1. Turn off the computer, wait a minute, and then turn the computer back on. Adjust the monitor's brightness and contrast controls. Is the monitor readable?</p> <p>Allow one minute for the computer to initialize its components.</p> <p>Yes. The problem is resolved.</p> <p>No. Go to step 2.</p> <p>2. Adjust the display's brightness. Is the full display readable?</p> <p>Yes. The external monitor may be defective. Go to step 3.</p> <p>No. The video controller on the system board may be defective. Call Dell for technical assistance.</p> <p>3. Turn off the computer and any attached devices. Disconnect all devices from the computer. Attach another external monitor to the computer.</p> <p>If you do not have another external monitor, call Dell for technical assistance.</p> <p>4. Reboot the computer, and adjust the monitor's brightness and contrast. Allow one minute for the computer to initialize its components.</p> <p>Is the monitor readable?</p> <p>Yes. The original monitor is defective. Call Dell for technical assistance.</p> <p>No. Call Dell for technical assistance.</p> |
| <p>No Image Appears on TV</p> | <p>Basic Checks:</p> <ul style="list-style-type: none"> 1 Eliminate possible interference. Turn off nearby fans, fluorescent lights, or halogen lamps to check for interference from those devices. 1 If you connected a TV to the S-video TV-out connector on your computer and there is no picture on your TV screen, verify the following connections and settings: <ul style="list-style-type: none"> o The proper cable is connected to the S-video TV-out connector on your computer. See "TV and Digital Audio." o Check for damaged or frayed cables and for bent pins on connectors. |

 **NOTE:** If your TV did not come with a composite video cable, you can purchase one from a local electronics store.

- o **Television Type** in the system setup program is set to the correct video standard for your country.
- o **Television Port** is **Enabled** in the system setup program.

Check the TV Type Setting

 **NOTE:** For more information on connecting a TV to your computer, see "[TV and Digital Audio](#)."

For Windows 2000

1. Save and close any open files, and exit any open application programs.
2. Shut down your computer.
3. Connect the proper video cable to the S-video TV-out connector on your computer. See "[TV and Digital Audio](#)."
4. Turn on your TV.
5. Verify that the correct video input is selected on the TV.
6. Restart your computer.
7. Click the **Start** button, point to **Settings**, and double-click **Control Panel**.
8. Double-click the **Display** icon.
9. Click the **Settings** tab.
10. Click the **Advanced** button.
11. Click the **TV** button.
12. Set the television type to **NTSC** (US) or **PAL** (Europe).

 **NOTE:** For more information on connecting a TV to your computer, see "[TV and Digital Audio](#)."

Sound and Speaker Problems

Basic Checks:

- 1 If using external speakers:
 - o Verify the speaker cable connections.
 - o Test the electrical outlet. Verify that the speakers are connected to a working electrical outlet. Ensure that the speakers are turned on.
 - o Eliminate possible interference. Turn off nearby fans, fluorescent lights, or halogen lamps to check for interference from those devices.
- 1 Adjust the volume.
- 1 [Reinstall the audio driver](#) for your operating system.
- 1 If you are using a S/PDIF-capable device, make sure that the proper cable is connected to the S-video TV-out connector on your computer. See "[TV and Digital Audio](#)."

If the problem still exists after you complete the basic checks, fill out the [Diagnostics Checklist](#) as you perform the following steps:

1. Insert your *ResourceCD* into the CD drive, reboot the computer, and run the **Misc. PCI Devices** device group in the Dell Diagnostics. The **Misc. PCI Devices** device group checks the functionality of the audio controller.
2. Do the tests complete successfully?

Yes. The controller is functioning properly. If the problem persists, call Dell for technical assistance.

No. [Call Dell](#) for technical assistance.

DualPoint Device, Touch Pad, or Mouse Problems

Basic Checks

- 1 If you are using a mouse, ensure that the connector is firmly attached. Mouse extension cables can cause problems.
- 1 If you are using the touch pad or a PS/2 mouse, run the **Pointing Devices** test as described in "[Dell Diagnostics](#)."
- 1 Verify that the correct device is listed for the **Pointing Devices** option in the [system setup program](#). For a USB mouse, you do not have to change the setting. The computer automatically recognizes the USB mouse.
- 1 [Reinstall](#) the touch pad driver for your operating system.

 **NOTE:** Be sure to refer to the section specific to your operating system.



- 1 Restart the computer.

If the problem still exists after you complete the basic checks, fill out the [Diagnostics Checklist](#) as you perform the following steps:

1. Insert your *ResourceCD* into the CD drive, reboot the computer, and run the **Mouse** test in the **Pointing Devices** device group in the Dell Diagnostics. The **Mouse** test checks the functionality of the mouse controller (which affects the ability to move the pointer around the screen) and the operation of the touch pad buttons.
2. Do the tests complete successfully?

Yes. The controller is functioning properly. If the problem persists, call Dell for technical assistance.

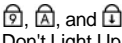
No. [Call Dell](#) for technical assistance.

| | |
|---|---|
|  <p>Num Lock, Caps Lock, and Scroll Lock Lights Don't Light Up</p> | <ol style="list-style-type: none"> 1. Press the <Num Lk>, <Scroll Lk>, and <Caps Lock> keys. 2. If their lights do not light, run the PC-AT Compatible Keyboards tests in the Dell Diagnostics. |
| <p>External Keyboard Doesn't Work</p> <p> When you attach an external keyboard, the integrated keyboard remains fully functional. During POST, the computer checks whether an external keyboard is connected; if it is, the computer recognizes both the integrated keyboard and the external keyboard.</p> <p>Use the integrated keyboard:</p> <ul style="list-style-type: none"> 1 when working in MS-DOS mode 1 when running the Dell Diagnostics 1 when using the system setup program | <p>Basic Checks:</p> <ul style="list-style-type: none"> 1 Disconnect the keyboard cable from the computer and check the cable connector for bent or broken pins. Check for damaged or frayed cables. 1 Check for interference. Keyboard extension cables can cause problems 1 Run the PC-AT Compatible Keyboards tests as described in "Dell Diagnostics." 1 Restart the computer. <p>If the problem still exists after you complete the basic checks, fill out the Diagnostics Checklist as you perform the following steps:</p> <ol style="list-style-type: none"> 1. Turn off the computer, and then remove the keyboard cable and check it for bent or broken pins. <p>Yes. If you see bent pins and they can be straightened, straighten them and go to step 2. If they cannot be straightened, or are broken, you need a new keyboard.</p> <p>No. Go to step 2.</p> 2. Reconnect the keyboard to the computer. 3. Make sure the cable from the external keyboard is firmly connected to the keyboard/mouse connector on the back of the computer. 4. Turn on the computer. 5. If you are using a keyboard that can be configured with various switch settings, make sure the switch is set to PS/2, Enhanced XT/AT, or PC/AT. <p>The switch settings are usually on the bottom of the keyboard, sometimes behind a panel tab. Refer to the documentation that came with the keyboard for more information.</p> 6. Turn off the computer, wait one minute, and then turn it on again. During the boot routine, do the Num Lock, Caps Lock, and Scroll Lock lights on the external keyboard blink momentarily? <p>Yes. Go to step 7.</p> <p>No. You may have a defective keyboard. Go to step 10.</p> 7. Does the computer recognize the external keyboard? <p>Use the external keyboard to type some characters. Do they appear on the display?</p> <p>Yes. The problem is resolved.</p> <p>No. Go to step 8.</p> 8. Turn off the computer and disconnect the external keyboard from the computer. 9. Turn on the computer. Does the computer recognize the integrated keyboard? <p>Allow one minute for the computer to initialize its components. Then use the computer's integrated keyboard to type some characters. Do the characters appear on the display?</p> <p>Yes. The external keyboard may be defective. Run the PC-AT Compatible Keyboards device group in the Dell Diagnostics. If you cannot isolate the problem after running the diagnostics, call Dell for technical assistance.</p> <p>No. Go to step 10.</p> 10. Call Dell for technical assistance. |
| <p>Devices Attached to Serial or Parallel Ports Don't Work</p> <p> If you are having a problem with a printer, see "Parallel Port Printer Doesn't Work."</p> <p>If a system error message indicates a port problem or if equipment connected to a port seems to perform incorrectly or not at all, the source of the problem may</p> | <p>Basic Checks for All Devices:</p> <ul style="list-style-type: none"> 1 Make sure that the device's cable is firmly connected to its connector on the computer. 1 Test the electrical outlet. Verify that the device is connected to a working electrical outlet. Verify that the device is on. <p>Basic Checks for Serial Device:</p> <ol style="list-style-type: none"> 1. Exit any open application programs, and then turn off the computer and the serial device. 2. Swap the device's cable with a known working cable. 3. Turn on the computer and the serial device. <p>Is the problem resolved?</p> |

be any of the following:

- 1 A faulty connection between the I/O port and the device
- 1 Incorrect settings for system setup options
- 1 Incorrect settings in the operating system's configuration files
- 1 A faulty cable between the I/O port and the device
- 1 A faulty device
- 1 Faulty I/O port logic on the system board
- 1 Conflicting COM port settings
- 1 Lack of drivers

Yes. You probably need a new device cable. [Call Dell](#) for technical assistance.

No. Go to step 4.

4. Turn off the computer and the serial device and swap the device with a comparable working device.

For example, if your serial mouse has a problem, swap it with a serial mouse you know is working properly.

5. Turn on the computer and the serial device.

Is the problem resolved?

Yes. You probably need a new device. Call Dell for technical assistance.

No. Call Dell for technical assistance.

Checking the Serial or Parallel Port on the Computer:

Fill out the [Diagnostics Checklist](#) as you perform the following steps:

1. Check the settings for the **Serial Port** and **Parallel Mode** options in the [system setup program](#).

Are the communication port options set correctly for the devices connected to the computer?

Yes. Go to step 3.

No. Go to step 2.

2. Change the **Serial Port** and **Parallel Mode** options to the appropriate settings, and then reboot the system.

Is the problem resolved?

Yes. The problem is resolved.

No. Go to step 3.

3. Check the contents of your initialization and start-up files. (See "[Software Solutions](#).")

Are the port configuration commands correct?

Yes. Go to step 5.

No. Go to step 4.

4. Change the necessary statements in the start-up files.

If the port problem is confined to a particular application program, see the application program's documentation for specific port configuration requirements.

Is the problem resolved?

Yes. The problem is resolved.

No. Go to step 5.

5. Insert your *ResourceCD* into the CD drive, reboot the computer, and run the **Serial Ports** device group and/or the **Parallel Ports** device group in the [Dell Diagnostics](#).

The **Serial Ports** device group and the **Parallel Ports** device group check the basic functions of the system board's I/O port logic. Also, if a parallel printer is attached to the parallel port, the **Parallel Ports** device group tests the communication link between the system board's I/O port logic and the printer.

Do the tests complete successfully?

Yes. The problem is with the serial device. Run the basic checks for the serial device. If you have completed the basic checks and the problem persists, [call Dell](#).

No. [Call Dell](#) for technical assistance.

Parallel Port Printer Doesn't Work

Basic Checks:

- 1 Verify the printer cable connections. Ensure that the printer cable is properly connected to the computer.
- 1 Test the electrical outlet. Verify that the printer is connected to a working electrical outlet. Ensure that the printer is turned on.

| | |
|--|---|
| | <p>Fill out the Diagnostics Checklist as you perform the following steps:</p> <ol style="list-style-type: none"> 1. Turn off the printer and computer. 2. Swap the printer's cable with a known working cable. 3. Turn on the printer and computer. 4. Try to print. <p>Does the print operation complete successfully?</p> <p>Yes. You probably need a new printer cable. Call Dell for technical assistance.</p> <p>No. Go to step 5.</p> <ol style="list-style-type: none"> 5. Run the printer's self-test. <p>Does the self-test complete successfully?</p> <p>Yes. Go to step 6.</p> <p>No. The printer is probably defective. If you bought the printer from Dell, call Dell for technical assistance. If you purchased the printer elsewhere, take it to one of the manufacturer's authorized service centers for repair.</p> <ol style="list-style-type: none"> 6. Try to print again. <p>Does the print operation complete successfully?</p> <p>Yes. The problem is resolved.</p> <p>No. Call Dell for technical assistance.</p> |
| <p>Software Solutions</p> <p> Software usually includes installation instructions in its accompanying documentation and a software setup program (usually called setup.exe or install.exe) on a floppy disk or CD.</p> <p>Error messages can be produced by an application program, the operating system, or the computer. "Understanding Error Messages," discusses the error messages generated by the computer. If you receive an error message not listed, check the operating system or application program documentation.</p> | <p>Basic Checks</p> <ol style="list-style-type: none"> 1. Ensure that you properly installed and configured the application program. Reinstall the program if necessary. 1. Verify that the program's drivers do not conflict with certain application programs. 1. Confirm that a problem is software-related by running the System Board Devices tests as described in "Dell Diagnostics." If all tests in the device group run successfully, the error condition may be related to a software problem. 1. For detailed troubleshooting information on a particular application program, see the software documentation or contact the software manufacturer. <p>Before installing software:</p> <ol style="list-style-type: none"> 1. Ensure that the application program is compatible with the operating system installed in your computer and that your computer meets the minimum hardware requirements needed to run the software. 1. Use a virus-scanning application program to check the floppy disks or CDs for viruses. |

[Back to Contents Page](#)

Technical Specifications: Dell Precision™ Mobile Workstation M40 User's Guide

- [Processor](#)
- [PC Cards](#)
- [Memory](#)
- [Connectors](#)
- [Audio](#)
- [Video](#)
- [Display](#)
- [Keyboard](#)
- [Battery](#)
- [AC Adapter](#)
- [Physical](#)
- [Environmental \(Computer\)](#)
- [Touch Pad](#)
- [Track Stick](#)
- [Modem](#)
- [Supported CD/DVD Formats](#)
- [Fixed Optical Drives](#)

Processor

| | |
|-------------------------------|---|
| Microprocessor | Intel® Mobile Pentium® III microprocessor |
| System chip set | Intel 815EP |
| L2 cache | 512 KB |
| External bus | 133 MHz Front Side Bus |
| Microprocessor data bus width | 64 bits |
| DRAM bus width | 64 bits |
| Address bus width | 32 bits |
| Flash EPROM | 4 Mb |
| AGP bus | 133 MHz |
| PCI bus | 33 MHz |

PC Cards

| | |
|------------------------|---|
| CardBus controller | Texas Instruments PCI 4450/4451 CardBus controller |
| PC Card connectors | two Type II cards in any combination; one Type III card used only in the lower connector |
| Cards supported | 3.3-V and 5-V <ul style="list-style-type: none"> Type II and Type III PC Cards (including memory cards) ATA cards that emulate IDE hard drives I/O cards such as modems, LAN cards, wireless LAN cards, and SCSI cards |
| PC Card connector size | 68 pins |
| Data width (maximum): | |
| PCMCIA | 16 bits |
| CardBus | 32 bits |

Memory

| | |
|-----------------------------------|------------------------------------|
| Architecture | PC133 SDRAM |
| Memory module sockets | two user-accessible SODIMM sockets |
| Memory module capacities and type | 256-MB |

| | |
|--------------------|---|
| | 3.3-V SDRAM SODIMMS |
| Maximum RAM | 512 MB |
| Memory clock speed | 133 MHz |
| Memory access time | CL2 (Note: CL2 indicates a CAS latency of 2 clocks) |

Connectors

| | |
|--------------------|---|
| Serial (DTE) | 16,550-compatible, 16-byte buffer connector |
| Parallel | unidirectional (standard AT), bidirectional, or ECP connector |
| Video | VGA connector |
| PS/2 | mini-DIN connector |
| Infrared | port compatible with both IrDA Standard 1.1 (Fast IR) and IrDA Standard 1.0 (Slow IR) |
| Audio | stereo line-in minijack; microphone-in mini jack; headphones/speakers (line-out) minijack |
| USB | two USB-compliant connectors |
| Docking | connector for a Dell docking device |
| S-video TV-out | 7-pin mini-DIN connector for S-video (adapter cable supports composite video and S/PDIF) |
| Mini-PCI | Type IIIA mini-PCI card slot |
| Modem | RJ11 port for mini-PCI modem |
| Modem/Ethernet LAN | factory-configurable RJ11/RJ45 combination port for mini-PCI modem/network controller |
| IEEE 1394 | four-pin serial connector |

Audio

| | |
|----------------------------|--|
| Audio type | Sound Blaster (software emulation-capable) |
| Audio controller | ESS Maestro 3i |
| Stereo conversion | 16 bit (analog-to-digital and digital-to-analog) |
| Interfaces: | |
| Internal | PCI bus/AC97 |
| External | stereo line-in minijack; microphone-in minijack; headphones/speakers (line-out) minijack |
| Speakers | two 8-ohm speakers |
| Internal speaker amplifier | 1.5-W (maximum) channel into two 8-ohms stereo |
| Controls | volume can be controlled through key combinations and application program menu |

Video

| | |
|------------------|---|
| Video type | 256-bit internal data path hardware accelerated video support |
| Data bus | 4X AGP |
| Video controller | NVIDIA Quadro2 Go™ |
| Video memory | 32 MB (standard) with 64-bit memory bus |

Display Resolution, Colors, and Refresh Rates

| Resolution | Color Depth | External Monitor Available Refresh | TV as Secondary Display Available Refresh |
|-----------------|-------------|------------------------------------|---|
| 640 x 480 (VGA) | 256 (8-bit) | 60, 75, 85 Hz | 60 Hz NTSC, 50 Hz PAL |

| | | | |
|---------------------|----------------|-----------------------|-----------------------|
| 640 x 480 (VGA) | 65 K (16-bit) | 60, 75, 85 Hz | 60 Hz NTSC, 50 Hz PAL |
| 640 x 480 (VGA) | 4.2 B (32-bit) | 60, 75, 85 Hz | 60 Hz NTSC, 50 Hz PAL |
| 800 x 600 (SVGA) | 256 (8-bit) | 60, 70, 72, 75, 85 Hz | 60 Hz NTSC, 50 Hz PAL |
| 800 x 600 (SVGA) | 65 K (16-bit) | 60, 70, 72, 75, 85 Hz | 60 Hz NTSC, 50 Hz PAL |
| 800 x 600 (SVGA) | 4.2 B (32-bit) | 60, 70, 72, 75, 85 Hz | 60 Hz NTSC, 50 Hz PAL |
| 1024 x 768 (XGA) | 256 (8-bit) | 60, 70, 72, 75, 85 Hz | 60 Hz NTSC, 50 Hz PAL |
| 1024 x 768 (XGA) | 65 K (16-bit) | 60, 70, 72, 75, 85 Hz | 60 Hz NTSC, 50 Hz PAL |
| 1024 x 768 (XGA) | 4.2 B (32-bit) | 60, 70, 72, 75, 85 Hz | 60 Hz NTSC, 50 Hz PAL |
| 1280 x 1024 (SXGA) | 256 (8-bit) | 60, 70, 72, 75, 85 Hz | 60 Hz NTSC, 50 Hz PAL |
| 1280 x 1024 (SXGA) | 65 K (16-bit) | 60, 70, 72, 75, 85 Hz | 60 Hz NTSC, 50 Hz PAL |
| 1280 x 1024 (SXGA) | 4.2 B (32-bit) | 60, 70, 72, 75, 85 Hz | 60 Hz NTSC, 50 Hz PAL |
| 1400 x 1050 (SXGA+) | 256 (8-bit) | 60, 70, 72, 75, 85 Hz | 60 Hz NTSC, 50 Hz PAL |
| 1400 x 1050 (SXGA+) | 65 K (16-bit) | 60, 70, 72, 75, 85 Hz | 60 Hz NTSC, 50 Hz PAL |
| 1400 x 1050 (SXGA+) | 4.2 B (32-bit) | 60, 70, 72, 75, 85 Hz | 60 Hz NTSC, 50 Hz PAL |
| 1600 x 1200 (UXGA) | 256 (8-bit) | 60, 70, 72, 75, 85 Hz | 60 Hz NTSC, 50 Hz PAL |
| 1600 x 1200 (UXGA) | 65 K (16-bit) | 60, 70, 72, 75, 85 Hz | 60 Hz NTSC, 50 Hz PAL |
| 1600 x 1200 (UXGA) | 4.2 B (32-bit) | 60, 70, 72, 75, 85 Hz | 60 Hz NTSC, 50 Hz PAL |

NOTE: Color depth is based on 256 colors for 8-bit, 65,536 colors for 16-bit, and 4,294,967,296 colors for 32-bit displays.

Display Resolution and Color Depth Without DVD and 3D Running

| Primary | Secondary/Maximum Color Depth Possible (in bits) | | | | | |
|----------------------|--|-----------|------------|-------------|-------------|-------------|
| | 640 x 480 | 800 x 600 | 1024 x 768 | 1280 x 1024 | 1400 x 1050 | 1600 x 1200 |
| 640 x 480 (8 bit) | 32 | 32 | 32 | 32 | 32 | 32 |
| 800 x 600 (8 bit) | 32 | 32 | 32 | 32 | 32 | 32 |
| 1024 x 768 (8 bit) | 32 | 32 | 32 | 32 | 32 | 32 |
| 1280 x 1024 (8 bit) | 32 | 32 | 32 | 32 | 32 | 32 |
| 1400 x 1050 (8 bit) | 32 | 32 | 32 | 32 | 32 | 32 |
| 1600 x 1200 (8 bit) | 32 | 32 | 32 | 32 | 32 | 32 |
| 640 x 480 (16 bit) | 32 | 32 | 32 | 32 | 32 | 32 |
| 800 x 600 (16 bit) | 32 | 32 | 32 | 32 | 32 | 32 |
| 1024 x 768 (16 bit) | 32 | 32 | 32 | 32 | 32 | 32 |
| 1280 x 1024 (16 bit) | 32 | 32 | 32 | 32 | 32 | 32 |
| 1400 x 1050 (16 bit) | 32 | 32 | 32 | 32 | 32 | 32 |
| 1600 x 1200 (16 bit) | 32 | 32 | 32 | 32 | 32 | 32 |
| 640 x 480 (32 bit) | 32 | 32 | 32 | 32 | 32 | 32 |
| 800 x 600 (32 bit) | 32 | 32 | 32 | 32 | 32 | 32 |
| 1024 x 768 (32 bit) | 32 | 32 | 32 | 32 | 32 | 32 |
| 1280 x 1024 (32 bit) | 32 | 32 | 32 | 32 | 32 | 32 |
| 1400 x 1050 (32 bit) | 32 | 32 | 32 | 32 | 32 | 32 |
| 1600 x 1200 (32 bit) | 32 | 32 | 32 | 32 | 32 | 16 |

Display

Type

UXGA active-matrix color (TFT)

| | |
|---------------------------------------|--|
| Dimensions (active area): 15.0 inches | |
| Height | 228.1 mm (9.0 inches) |
| Width | 304.1 mm (12.0 inches) |
| Diagonal | 380.1 mm (15.0 inches) |
| Maximum resolution/colors | 1600 x 1200/32-bit color (UXGA) |
| Response time (typical) | 50.0 ms (20 ms rise, 30 ms fall) |
| Refresh rate | 60 Hz |
| Operating angle | 0° (closed) to 180° |
| Viewing angles: | |
| Horizontal | ± 40° |
| Vertical | +15°/-30° |
| Dot pitch | 0.19 mm (15.0-inch UXGA) |
| Power consumption: | |
| Panel (typical) | 1.3 W |
| Backlight | 3.4 W using battery, 4.9 W using AC adapter |
| Controls | brightness can be controlled through a key combination |

Keyboard

| | |
|----------------|---|
| Number of keys | 87 (U.S., Canada, Korea, Thailand, and locations that use traditional Chinese); 88 (Europe); 90 (Japan) |
| Key travel | 2.7 mm + 0.3 mm/- 0.4 mm (0.11 inch ± 0.016 inch) |
| Key spacing | 19.05 mm ± 0.3 mm (0.75 inch ± 0.012 inch) |

Battery

| | |
|--|--|
| Type | 8-cell lithium ion (dual battery support is available via the modular bay) |
| Dimensions: | |
| Height | 21.5 mm (0.83 inch) |
| Depth | 88.5 mm (3.48 inches) |
| Width | 139.0 mm (5.47 inches) |
| Weight | 8 cell: 0.39 kg (0.87 lb) |
| Voltage | 14.8 VDC |
| Capacity | 8 cell: 59.0 WH |
| Charge time (approximate) ¹ : | |
| Computer on | 2.5 hr |
| Computer off | 1 hr |
| Battery life | 2–4 hours minimum with 8-cell standard battery |
| Life span (approximate) ¹ | 400 discharge/charge cycles |

Temperature range:

Operating 0° to 45°C (32° to 113°F)

Storage -20° to 60°C (-4° to 140°F)

¹ Battery performance features such as charge time and life span can vary according to the conditions under which the computer and battery are used.

AC Adapter

Input voltage 90 to 135 VAC and 164 to 264 VAC

Input current (maximum) 1.5 A

Input frequency 47 to 63 Hz

Output current 4.5 A (maximum at 4-second pulse);
3.5 A (continuous)

Rated output voltage 20.0 VDC

Height 27.94 mm (1.1 inches)

Width 58.42 mm (2.3 inches)

Depth 133.35 mm (5.25 inches)

Weight (with cables) 0.4 kg (0.9 lb)

Temperature range:

Operating 0° to 40°C (32° to 104°F)

Storage -40° to 65°C (-40° to 149°F)

Physical

Computers with a 15.0-inch display:

Height 44.5 mm (1.75 inches)

Width 331.0 mm (13.03 inches)

Depth 276.0 mm (10.87 inches)

Weight ² 3.28 kg (7.22 lb) with travel module installed in modular bay
3.48 kg (7.68 lb) with standard floppy drive installed in modular bay

² Your computer's actual weight depends on its configuration.

Environmental (Computer)

Temperature:

Operating 0° to 35°C (32° to 95°F)

Storage -40° to 65°C (-40° to 149°F)

Relative humidity (maximum):

Operating 10% to 90% (noncondensing)

Storage 5% to 95% (noncondensing);
20% at 65°C (149°F)

Maximum vibration:

| | |
|------------------------------|--|
| Operating | 0.9 GRMS using a random-vibration spectrum that simulates user environment |
| Storage | 1.3 GRMS using a random-vibration spectrum that simulates air/truck shipment |
| Maximum shock ³ : | |
| Operating | 152.4 cm/sec (60.0 inches/sec) (equal to a half-sine pulse width of 2 ms) |
| Storage | 203.2 cm/sec (80 inches/sec) (equal to a half-sine pulse width of 2 ms) |
| Altitude (maximum): | |
| Operating | -15.2 to 3048 m (-50 to 10,000 ft) |
| Storage | -15.2 to 10,668 m (-50 to 35,000 ft) |

³ Measured with the hard drive in head-parked position.

Touch Pad

| | |
|---|--|
| Interface | PS/2-compatible |
| X/Y position resolution (graphics table mode) | 240 cpi |
| Size: | |
| Thickness | 2.00 mm (0.08 inch) at highest component |
| Width (sensor-active area) | 64.88 mm (2.55 inch) |
| Height | 48.88 mm (1.92 inch) rectangle |
| Weight | 6.5 g (0.23 oz) |
| Power: | |
| Supply voltage | 5 V ± .5 VDC |
| Supply current | 25 mA (maximum operating for track stick and touch pad combined) |
| ESD | in accordance with IEC-801-2 |

Track Stick

| | |
|-------------------------|--|
| Interface | PS/2-compatible |
| X/Y position resolution | 250 counts/sec. @100gf |
| Size: | protrudes 0.5 mm (.02 inch) higher than surrounding keycaps |
| Power: | |
| Supply voltage | 5 V ± .5 VDC |
| Supply current | 25 mA (maximum operating for track stick and touch pad combined) |
| ESD | in accordance with IEC-801-2 |

Modem

| | |
|--|--|
| Data/fax and network adapter combination modem | 3Com® 10/100 LAN + 56K, V.90 Mini PCI Modem. For more information, see the online documentation for the modem. |
|--|--|

Supported CD/DVD Formats

- | CD-ROM red-book audio discs (CD-DA)
 - | CD-ROM yellow-book mode-1 and mode-2 data discs
 - | CD-ROM XA (mode-2 form 1 and form 2; without Adaptive Differential Pulse Code modulation [ADPCM])
 - | CD-I (mode-2 form 1 and form 2)
 - | CD-I Ready
 - | CD-Bridge
 - | Photo CD, CD-recordable (CD-R) (single and multisession)
 - | Video CD
 - | CD-rewritable (CD-RW) (only the CD-RW drives can write to this type of disc; the CD-ROM and DVD drives can read, but not write to, CD-RWs)
 - | DVD-5 (the DVD drive supports the DVD-5 format)
-

Fixed Optical Drives

Supported 12.5-mm drives

combo DVD/CD-RW

[Back to Contents Page](#)

Traveling With Your Computer: Dell Precision™ Mobile Workstation M40 User's Guide

[Identifying Your Computer](#)

[Traveling by Air](#)

[Packing the Computer](#)

[If Your Computer Is Lost or Stolen](#)

[Travel Tips](#)

Identifying Your Computer

- 1 Attach a nametag or business card to the computer, or, use a permanent marker or stencil to write a unique identifying mark (such as your driver's license number) on the computer. If a lost or stolen computer is recovered, such marking identifies the computer as your property.
 - 1 Write down your service tag sequence and store it in a safe place separate from the computer or carrying case. If the computer is lost or stolen, use the service tag sequence when reporting to law enforcement officials and to Dell.
 - 1 Use a text editor (such as Microsoft® Windows® Notepad) to create a file on the Windows desktop called **if_found**. Place information such as your name, address, and telephone number in this file.
 - 1 Contact your credit card company, and ask if it offers coded identification tags that allow your property to be returned to you without revealing your name, address, or telephone number.
-

Packing the Computer

- 1 Remove any external devices attached to the computer and store them in a safe place. Remove any cables attached to installed PC Cards (you do not have to remove the PC Cards themselves).
- 1 To make the computer as light as possible, remove all drive modules from the modular bay, and install the travel module.
- 1 To maximize battery operating time, fully charge the main battery and any spare batteries you plan to carry with you.
- 1 Turn off the computer or put the computer into [hibernate mode](#).
- 1 Disconnect the AC adapter.

NOTICE: When the display is closed, extraneous items on the keyboard could damage the display.

- 1 Remove any extraneous items, such as paper clips, pens, and paper, from the keyboard and then close the display.
- 1 Use the optional Dell carrying case.
- 1 Avoid packing the computer with items such as shaving cream, colognes, perfumes, or food.
- 1 Protect the computer, the batteries, and the hard drive from hazards such as extreme temperatures and overexposure to sunlight, dirt, dust, or liquids.
- 1 Pack the computer so that it does not slide around in the trunk of your car or in an overhead storage compartment.

NOTICE: Do not check the computer as baggage.

Travel Tips

NOTICE: Do not use the CD, DVD, or CD-RW drive while the computer is in motion. Doing so could interrupt the flow of data to and from the CD, DVD, or CD-RW drive and the hard drive or floppy drive.

- 1 Consider changing your [power management options](#) to maximize battery operating time.
- 1 If you are traveling internationally, carry proof of ownership—or of your right to use the computer if it is company-owned—to speed your passage through customs. Investigate the customs regulations of the countries you plan to visit and consider acquiring an international carnet (also known as a *merchandise passport*) from your government if you travel through many different countries. A carnet is an international customs document that facilitates temporary imports into foreign countries.
- 1 Make sure that you know which electrical outlets are used in the countries you will visit, and have appropriate power adapters.
- 1 Check with your credit card company for information about the kinds of emergency travel assistance they offer to mobile workstationcomputer users. Many companies provide services to help you solve problems, such as quickly locating floppy disks or providing

a direct-dial telephone line for your modem connection.

Traveling by Air

- 1 Be sure to have a charged battery available in case you are asked to turn on the computer.

NOTICE: Do not put the computer through a metal detector.

- 1 Have airport security personnel check the computer by hand. If the computer passes through a metal detector, you might lose data. If you must pass the computer through a metal detector, first remove the hard drive.
 - 1 Before you use the computer on an airplane, check the in-flight magazine or ask the flight crew to verify that such usage is permitted. Some airlines forbid the use of electronic devices during the flight. All airlines forbid the use of electronic devices during takeoff and landing.
-

If Your Computer Is Lost or Stolen

- 1 Call a law enforcement agency to report the lost or stolen computer. Include the service tag sequence in your description of the computer. Ask that a case number be assigned and write down the number, along with the name, address, and telephone number of the law enforcement agency. If possible, obtain the name of the investigating officer.

 *NOTE: If you know where the computer was lost or stolen, call a law enforcement agency in that area. If you do not know, call a law enforcement agency where you live.*

- 1 If the computer belongs to a company, notify the security office of the firm.
- 1 Call Dell customer support to report the missing computer. Provide the computer's service tag sequence, the case number, and the name, address, and telephone number of the law enforcement agency to which you reported the missing computer. If possible, give the name of the investigating officer.

The Dell support technician will log your report under the computer's service tag sequence and flag the computer as missing or stolen. If someone calls Dell for technical assistance and gives your service tag sequence, the computer is identified automatically as missing or stolen. The technician will attempt to get the phone number and address of the caller. Dell will then contact the law enforcement agency to which you made the report of the missing or stolen computer.

[Back to Contents Page](#)

[Back to Contents Page](#)

Using Your Computer: Dell Precision™ Mobile Workstation M40 User's Guide

[Modular Bay](#)

[Floppy Drive](#)

[CD, CD-RW, or DVD Drive](#)

[Display](#)

[Keyboard and Keypad Controls](#)

[Dell AccessDirect™ Key](#)

[Speaker Controls](#)

[Cursor Controls](#)

[PC Cards](#)

⚠ CAUTION: Do not operate your computer for an extended period of time with the base resting directly on your body. With extended operation, heat can potentially build up in the base. Allowing sustained contact with the skin could cause discomfort or, eventually, a burn.

Modular Bay

Your computer comes with a [floppy drive](#) installed in the modular bay. To use another device in the modular bay, first remove the floppy drive (see "[Swapping Devices While the Computer Is Off](#)" or "[Swapping Devices While the Microsoft® Windows® Operating System Is Running](#).")

NOTICE: When drives are not inside the computer, they are fragile and must be handled carefully to avoid damage. Do not press down on the drives or place heavy objects on top of them. Place the drives in a travel case to keep them free of dust and liquids. Store the drives in a safe place.

You can install the following modules in the modular bay:

- 1 [Second battery](#)
- 1 Floppy drive
- 1 CD drive
- 1 DVD drive
- 1 CD-RW drive
- 1 Second hard drive

To make the computer as light as possible, use the travel module in the modular bay in place of any of the available drives.

Swapping Devices While the Computer Is Off

1. Save and close any open files, exit any open programs, and shut down the computer.
2. If the computer is connected (docked) to an Advanced Port Replicator (APR), undock it.
3. Close the display and turn the computer over.
4. Slide and hold the latch release, and pull the device out of the bay.

NOTICE: To prevent damage to devices, place them in a travel case when they are not inserted in the computer. Store devices in a dry, safe place, and avoid pressing down on them or placing heavy objects on top of them.



NOTICE: Insert devices before you dock and turn on the computer.

5. Insert the new device into the bay, and push it until you hear a click.
6. Turn the computer over and open the display.
7. Turn on the computer.

Swapping Devices While the Microsoft Windows Operating System Is Running

NOTICE: To prevent damage to the docking connector, do not remove or replace devices while the computer is connected to an APR.

NOTICE: To prevent damage to devices, place them in a travel case when they are not inserted in the computer. Store devices in a dry, safe place, and avoid pressing down on them or placing heavy objects on top of them.



6. Insert the new device into the bay, and push the device in until you hear a click.
7. If necessary, enter your password to unlock your computer.

In Windows 2000

1. Double-click the  icon on the Windows taskbar.
2. Click the device you want to eject and then click **Stop**.
3. Click **OK**, and wait until the device you want to eject is cleared from the list of devices in the **Unplug or Eject Hardware** window.
4. Keep the display open, and tilt the computer back so that you can access the bottom of the computer.
5. Slide and hold the latch release, and pull the device out of the bay.

NOTICE: To prevent damage to devices, place them in a travel case when they are not inserted in the computer. Store devices in a dry, safe place, and avoid pressing down on them or placing heavy objects on top of them.



6. Insert the new device into the bay, and push the device in until you hear a click.

7. Turn the computer over and open the display.
 8. Press the power button to resume from standby mode.
 9. If necessary, enter your password to unlock your computer.
 10. When Windows resumes and recognizes the new device, click **Close**.
-

Floppy Drive

To use the floppy drive:

1. Insert a 3.5-inch floppy disk into the drive with the label side up and metal end first.
2. Push the floppy disk into the drive until the eject button extends outside the drive casing.

NOTICE: Do not travel with a floppy disk in the floppy drive. Doing so could break the eject button and damage the drive.

To remove a floppy disk from the drive:

1. Press the eject button to release the floppy disk.
2. Pull the floppy disk out of the drive.

To remove the drive or to use another device in the modular bay, see "[Swapping Devices While the Computer Is Off](#)" or "[Swapping Devices While the Computer Is On](#)."

NOTICE: When drives are not inside the computer, they are fragile and must be handled carefully to avoid damage. Do not press down on the drives or place heavy objects on top of them. Place the drives in a travel case to keep them free of dust and liquids. Store the drives in a safe place.

Caring for Floppy Disks

- 1. Never use damaged floppy disks in the computer.
 - 1. Do not store floppy disks near magnetic sources.
-

CD, CD-RW, or DVD Drive



Your computer comes with a DVD/ CD-RW combination drive installed as a fixed optical drive. See "[Technical Specifications](#)" for information on supported CD, CD-RW, and DVD formats.

NOTICE: Do not move the computer when using the drive.

NOTICE: Always use compressed air to clean the lens in the drive. Never touch the lens.

Playing a Disc

1. Press the eject button.
2. Pull the tray out.
3. Place the disc in the center of the tray, label side up.

NOTICE: If the disc is not seated correctly, the drive or media can be damaged.

4. Snap the disc onto the spindle.

5. Push the tray back into the drive.

The autoplay feature can interfere with the computer's power management functions. If Dell installed the operating system, the autoplay feature has been disabled. If you reinstall the operating system or if you installed it yourself, be sure to disable the autoplay feature if you want to use the drive. See "[Conserving Power](#)."

For instructions on changing the **Auto Insert Notification** option, see the operating system user's guide.

Caring for Discs





- 1 Never use a damaged or warped disc.
- 1 Always hold the disc by its edges. Do not touch the surface of the disc.
- 1 Use a clean, dry cloth to remove dust, smudges, or fingerprints from the surface of the disc. When cleaning the disk, wipe from the center of the disc to the edge.
- 1 Never use solvents, such as benzene, record cleaners, or antistatic sprays, to clean the disc.
- 1 Do not write on the surface of the disc.
- 1 Store the disc in its container, placing it in a cool, dry place. Extreme temperatures may damage discs.
- 1 Do not bend or drop a disc.
- 1 Do not place objects on top of a disc.

Display

When you run the computer on battery power, set the brightness control to the lowest setting that affords comfortable viewing. You can conserve battery power by using the minimum brightness setting.

Adjusting Brightness

 **NOTE:** On an external keyboard, press <Scroll Lock> with the key combinations in the following table if the **External Hot Key** option is enabled in the [system setup program](#).

| Keys | Function | Key Combination |
|---|---------------------|---|
|  | Increase brightness |   |
| | Decrease brightness |   |

Controlling Display Modes

Press   to switch the video image to the next display in the following sequence: the computer's display, the display and external monitor simultaneously, or an external monitor.

Customizing Display Resolution

In Windows 2000

1. Click the **Start** button, point to **Settings**, and then click **Control Panel**.
2. Double-click the **Display** icon, and then click the **Settings** tab.
3. Try different settings for **Colors** and **Screen area**.

For more information, see your operating system documentation.

If you choose a resolution or color palette that is higher than the display supports, the settings adjust automatically to the closest possible setting.

Video Drivers and Video Resolution

The Dell-installed video drivers work with the operating system to let you customize the video resolution and number of screen colors on your

display. For detailed information on video resolution, see "[Technical Specifications](#)."

If the video resolution setting is higher than that supported by the display, the computer enters *pan mode*. In pan mode the screen cannot be completely displayed. For example, the taskbar that usually appears at the bottom of the desktop may no longer be visible. To view the rest of the screen, use the touch pad or track stick to pan up and down and left and right.

NOTICE: You can damage the monitor by using an unsupported refresh rate. Before adjusting the refresh rate on an external monitor, see the monitor's user's guide.

If you select a resolution and color combination that the computer does not support, the computer automatically selects the next supported combination.

 **NOTE:** Color depth is based on 256 colors for 8-bit, 65,536 colors for 16-bit, and 4,294,967,296 colors for 32-bit displays.

Keyboard and Keypad Controls

Key combinations allow you to:

- 1 Use the [numeric keypad](#).
- 1 Enter [power management](#) modes.
- 1 Control [display](#) settings.
- 1 Control the [Dell AccessDirect](#) key.
- 1 Adjust [speaker](#) volume.









 **NOTE:** On an external keyboard, press <Scroll Lock> with the appropriate keys if the **External Hot Key** option is enabled in the [system setup program](#).

Numeric Keypad

The numeric keypad shares some of the keys on your computer's keyboard. The shared numbers and symbol characters are shown on the right side of the keys. When you activate the numeric keypad, the  light turns on.



Numeric Keypad Key Combinations

| Function | When Keypad Is Off |
|--|--|
| Turn on the keypad |  |
| Temporarily enable a cursor-control key in the keypad |  <cursor key> |
| Temporarily enable a number or symbol key on the keypad |   <number key> |
| Function | When Keypad Is On |
| Turn off the keypad |  |
| Temporarily enable the lowercase characters/functions of the keyboard |  <key> |
| Temporarily enables the uppercase characters/functions of the keyboard |   |
| Temporarily enable a cursor-control key in the keypad |  <cursor key> |

Power Conservation Key Combination

Press   to activate power conservation properties if you configured the power management properties. See "[Conserving Power](#)."

Dell AccessDirect™ Key



The Dell AccessDirect key allows you to quickly access a frequently used program, such as Microsoft Internet Explorer.

 **NOTE:** Using an external keyboard with your computer disables the AccessDirect key.

For information on using the AccessDirect key and viewing or changing key assignments, see the AccessDirect Help:

1. Open the Dell AccessDirect program in one of the following ways:
 - 1 Double-click the AccessDirect icon in the system tray on the Windows taskbar (normally in the bottom-right corner of the screen).
 - 1 In Windows 2000, click the **Start** button, point to **Settings**, and then double-click **Control Panel**. In the **Control Panel** window, double-click the **Keyboard** icon, and then click the **AccessDirect** tab.
 2. Click **Help**.
-

Speaker Controls



 **NOTE:** On an external keyboard, press <Scroll Lock> with the appropriate keys if the **External Hot Key** option is enabled in the [system setup program](#).

| Function | Key Combination |
|-----------------------------|---|
| Turn the volume up |   |
| Turn the volume down |   |
| Turn the speakers on or off |   |

Cursor Controls

Your computer is equipped with the Dell DualPoint integrated pointing device, which includes two cursor pointing devices that perform traditional mouse functions: the [touch pad](#) and the [track stick](#). You can choose to use the touch pad only, the track stick only, or both at the same time.

DualPoint device software allows you to adjust settings, such as sensitivity, motion, and drag and drop features for both the touch pad and track stick.

 **NOTE:** If the **Pointing Device** option in the [system setup program](#) is set to **Touch Pad-PS/2 Mouse** (the default), you can use both the DualPoint device and an [external mouse](#).

Using the Touch Pad



The two touch pad buttons, located directly below the touch pad, correspond to the left and right buttons on a mouse.

- 1 To move the cursor, lightly slide your finger over the smooth sensor area.
- 1 To select an object, gently tap once on the surface of the touch pad or use your thumb to press the left touch pad button.
- 1 To select and move (or drag) an object, position the cursor on the object and tap down-up-down on the touch pad. On the second down motion, leave your finger on the touch pad and move the selected object by sliding your finger across the surface.
- 1 To double-click an object, position the cursor on the object and then tap the touch pad or the left touch pad button twice.

Using the Track Stick



The two track stick buttons, located between the touch pad and the space bar on the keyboard, correspond to the left and right buttons on a mouse.

- 1 To move the cursor, apply pressure to the track stick with your index finger. Press up or down to move the cursor to the top or bottom of the display screen. Press left or right to move the cursor to the left or right of the display screen.
- 1 To select an object, tap once on the track stick or use your thumb to press the left track stick button.
- 1 To select and move (or drag) an object, position the cursor on the object. Then press and hold the left track stick button. Leave your thumb on the button and move the selected object by pressing the track stick in the desired direction.
- 1 To double-click an object, position the cursor on the object and then tap the left track stick button or the track stick itself twice. The track stick functions much like the touch pad in that it allows you to use buttons for mouse functions or the pointing device itself.

Customizing the DualPoint Integrated Pointing Device

In Windows 2000

1. Click the **Start** button, point to **Settings**, and then click **Control Panel**.
2. Double-click the **Mouse** icon and click the **Touch** tab in the **Mouse Properties** window.
3. In the drop-down menu, click to select either the touch pad or the pointing stick (track stick) and click **Apply**.

4. Click **OK** to save the settings and close the window.

To open the **Mouse Properties** window, you can also right-click the **Touch Pad** icon on the taskbar, and click **Touch Pad Properties**.

To disable the selected touch pad or track stick settings, click in the **Disable this Device** box. If you docked your computer with a mouse, the touch pad and track stick settings are automatically disabled.

Changing the Track Stick Cap

Your computer came with additional track stick caps. You may need to change the track stick cap if it wears down from prolonged use.

1. Pull the cap off the track stick.



2. Align a new cap over the square track stick post and gently press the cap down onto the post.
3. Test the track stick to ensure that the cap is seated properly.

PC Cards

See "[Technical Specifications](#)" for information on supported PC Cards.

 **NOTES:** A PC Card is not a boot device. The "type" of a card refers to its thickness, not its functionality.

Your computer recognizes most I/O cards and automatically loads the device driver associated with the card.

NOTICE: Extended cards are longer versions of standard PC Cards. They fit into and operate correctly with your computer. Follow these precautions when using extended PC Cards:

- 1. **Make sure that nothing strikes the exposed end of an installed extended card. Otherwise, damage to the system board can occur.**
- 1. **Always remove an extended PC Card before you pack the computer in its carrying case.**
- 1. **Try installing an extended card in the upper PC Card slot to allow room for a second PC Card.**

Removing PC Cards and Blanks

NOTICE: Use the PC Card configuration utility on the taskbar to select and disable a card before you remove it. If you do not disable the card using the configuration utility, you could lose data from open programs.

1. Disable the PC Card by using the PC Card configuration utility on the taskbar.
2. Press the eject button.

 **NOTE:** A dot on each eject button indicates whether the button is for the top or bottom PC Card slot.



3. Gently remove the card or blank.

Save a blank to use whenever you do not have a PC Card installed. The blank protects the PC Card slot from dust and other particles.

Installing PC Cards

You do not need to turn off your computer or exit suspend or standby mode before you install a PC Card.

1. If necessary, [remove the blank](#) from the PC Card slot.
2. Insert the card, and press in firmly until the card is completely seated.

If card orientation is not clear, see the documentation that came with the card.



3. If you encounter resistance when inserting the card, do not force it. Check the card's orientation and try again.

Configuring PC Cards

The PC Card configuration utility performs the following functions:

- 1. Notifies you whenever a PC Card is inserted and tells you how the card is configured
- 1. Automatically loads the proper device driver if the driver is available on the hard drive
- 1. Prompts you to install drivers if they are not available on the hard drive

[Back to Contents Page](#)

[Back to Contents Page](#)

Limited Warranty and Return Policy: Dell Precision™ Mobile Workstation M40 User's Guide

[Three-Year Limited Warranty \(U.S. Only\)](#)

[One-Year End-User Manufacturer Guarantee \(Latin America and the Caribbean Only\)](#)

[Three-Year Limited Warranty \(Canada Only\)](#)

["Total Satisfaction" Return Policy \(U.S. and Canada Only\)](#)

Three-Year Limited Warranty (U.S. Only)

Dell Computer Corporation ("Dell") manufactures its hardware products from parts and components that are new or equivalent to new in accordance with industry-standard practices. Dell warrants that the hardware products it manufactures will be free from defects in materials and workmanship. The limited warranty term is three years beginning on the date of invoice, as described in the following text.

Damage due to shipping the products to you is covered under this limited warranty. Otherwise, this limited warranty does not cover damage due to external causes, including accident, abuse, misuse, problems with electrical power, servicing not authorized by Dell, usage not in accordance with product instructions, failure to perform required preventive maintenance, and problems caused by use of parts and components not supplied by Dell.

This limited warranty does not cover any items that are in one or more of the following categories: software; external devices (except as specifically noted); accessories or parts added to a Dell system after the system is shipped from Dell; accessories or parts added to a Dell system through Dell's system integration department; accessories or parts that are not installed in the Dell factory; or DellWare™ products. Monitors, keyboards, and mice that are Dell-branded or that are included on Dell's standard price list are covered under this limited warranty; all other monitors, keyboards, and mice (including those sold through the DellWare program) are not covered. Batteries for portable computers are covered only during the initial one-year period of this limited warranty.

Coverage During Year One

During the one-year period beginning on the invoice date, Dell will repair or replace products covered under this limited warranty that are returned to Dell's facility. To request warranty service, you must contact Dell's Customer Technical Support within the warranty period. See "[Contacting Dell](#)" to find the appropriate contact information for obtaining customer assistance. If warranty service is required, Dell will issue a Return Material Authorization Number. You must ship the products back to Dell in their original or equivalent packaging, prepay shipping charges, and insure the shipment or accept the risk of loss or damage during shipment. Dell will ship the repaired or replacement products to you freight prepaid if you use an address in the continental U.S., where applicable. Shipments to other locations will be made freight collect.

NOTE: Before you ship the product(s) to Dell, back up the data on the hard drive(s) and any other storage device(s) in the product(s). Remove any removable media, such as floppy disks, CDs, or PC Cards. Dell does not accept liability for lost data or software.

Dell owns all parts removed from repaired products. Dell uses new and reconditioned parts made by various manufacturers in performing warranty repairs and building replacement products. If Dell repairs or replaces a product, its warranty term is not extended.

Coverage During Years Two and Three

During the second and third years of this limited warranty, Dell will provide, on an exchange basis and subject to Dell's Exchange Policy in effect on the date of the exchange, replacement parts for the Dell hardware product(s) covered under this limited warranty when a part requires replacement. You must report each instance of hardware failure to Dell's Customer Technical Support in advance to obtain Dell's concurrence that a part should be replaced and to have Dell ship the replacement part. Dell will ship parts (freight prepaid) if you use an address in the continental U.S., where applicable. Shipments to other locations will be made freight collect. Dell will include a prepaid shipping container with each replacement part for your use in returning the replaced part to Dell. Replacement parts are new or reconditioned. Dell may provide replacement parts made by various manufacturers when supplying parts to you. The warranty term for a replacement part is the remainder of the limited warranty term.

You will pay Dell for replacement parts if the replaced part is not returned to Dell. The process for returning replaced parts, and your obligation to pay for replacement parts if you do not return the replaced parts to Dell, will be in accordance with Dell's Exchange Policy in effect on the date of the exchange.

You accept full responsibility for your software and data. Dell is not required to advise or remind you of appropriate backup and other procedures.

General Provisions

THIS LIMITED WARRANTY GIVES YOU SPECIFIC LEGAL RIGHTS, AND YOU MAY ALSO HAVE OTHER RIGHTS, WHICH VARY FROM STATE TO STATE (OR JURISDICTION TO JURISDICTION). DELL'S RESPONSIBILITY FOR MALFUNCTIONS AND DEFECTS IN HARDWARE IS LIMITED TO REPAIR AND REPLACEMENT AS SET FORTH IN THIS LIMITED WARRANTY STATEMENT. ALL EXPRESS AND IMPLIED WARRANTIES FOR THE PRODUCT, INCLUDING BUT NOT LIMITED TO ANY IMPLIED WARRANTIES OF AND CONDITIONS OF MERCHANTABILITY AND FITNESS FOR A PARTICULAR PURPOSE, ARE LIMITED IN DURATION TO THE WARRANTY PERIOD SET FORTH ABOVE AND NO WARRANTIES, WHETHER EXPRESS OR IMPLIED, WILL APPLY AFTER SUCH PERIOD.

SOME STATES (OR JURISDICTIONS) DO NOT ALLOW LIMITATIONS ON HOW LONG AN IMPLIED WARRANTY LASTS, SO THE PRECEDING LIMITATION MAY NOT APPLY TO YOU.

DELL DOES NOT ACCEPT LIABILITY BEYOND THE REMEDIES SET FORTH IN THIS LIMITED WARRANTY STATEMENT OR LIABILITY FOR INCIDENTAL OR CONSEQUENTIAL DAMAGES, INCLUDING WITHOUT LIMITATION ANY LIABILITY FOR PRODUCTS NOT BEING AVAILABLE FOR USE OR FOR LOST DATA OR SOFTWARE.

SOME STATES (OR JURISDICTIONS) DO NOT ALLOW THE EXCLUSION OR LIMITATION OF INCIDENTAL OR CONSEQUENTIAL DAMAGES, SO THE PRECEDING EXCLUSION OR LIMITATION MAY NOT APPLY TO YOU.

These provisions apply to Dell's three-year limited warranty only. For provisions of any service contract covering your system, refer to your invoice or the separate service contract that you will receive.

If Dell elects to exchange a system or component, the exchange will be made in accordance with Dell's Exchange Policy in effect on the date of the exchange. In any instance in which Dell issues a Return Material Authorization Number, Dell must receive the product(s) for repair prior to the expiration of the warranty period in order for the repair(s) to be covered by the limited warranty.

NOTE: If you chose one of the available warranty and service options in place of the standard three-year limited warranty described in the preceding text, the option you chose will be listed on your invoice.

Three-Year Limited Warranty (Canada Only)

Dell Computer Corporation ("Dell") manufactures its hardware products from parts and components that are new or equivalent to new in accordance with industry-standard practices. Dell warrants that the hardware products it manufactures will be free from defects in materials and workmanship. The limited warranty term is three years beginning on the date of invoice, as described in the following text.

Damage due to shipping the products to you is covered under this limited warranty. Otherwise, this limited warranty does not cover damage due to external causes, including accident, abuse, misuse, problems with electrical power, servicing not authorized by Dell, usage not in accordance with product instructions, failure to perform required preventive maintenance, and problems caused by use of parts and components not supplied by Dell.

This limited warranty does not cover any items that are in one or more of the following categories: software; external devices (except as specifically noted); accessories or parts added to a Dell system after the system is shipped from Dell; accessories or parts added to a Dell system through Dell's system integration department; accessories or parts that are not installed in the Dell factory; or DellWare products. Monitors, keyboards, and mice that are Dell-branded or that are included on Dell's standard price list are covered under this limited warranty; all other monitors, keyboards, and mice (including those sold through the DellWare program) are not covered. Batteries for portable computers are covered only during the initial one-year period of this limited warranty.

Coverage During Year One

During the one-year period beginning on the invoice date, Dell will repair or replace products covered under this limited warranty that are returned to Dell's facility. To request warranty service, you must contact Dell's Customer Technical Support within the warranty period. See "[Contacting Dell](#)" to find the appropriate telephone number for obtaining customer assistance. If warranty service is required, Dell will issue a Return Material Authorization Number. You must ship the products back to Dell in their original or equivalent packaging, prepay shipping charges, and insure the shipment or accept the risk of loss or damage during shipment. Dell will ship the repaired or replacement products to you freight prepaid if you use an address in Canada, where applicable. Shipments to other locations will be made freight collect.

NOTE: Before you ship the product(s) to Dell, back up the data on the hard drive(s) and any other storage device(s) in the product(s). Remove any removable media, such as floppy disks, CDs, or PC Cards. Dell does not accept liability for lost data or software.

Dell owns all parts removed from repaired products. Dell uses new and reconditioned parts made by various manufacturers in performing warranty repairs and building replacement products. If Dell repairs or replaces a product, its warranty term is not extended.

Coverage During Years Two and Three

During the second and third years of this limited warranty, Dell will provide, on an exchange basis and subject to Dell's Exchange Policy in effect on the date of the exchange, replacement parts for the Dell hardware product(s) covered under this limited warranty when a part requires replacement. You must report each instance of hardware failure to Dell's Customer Technical Support in advance to obtain Dell's concurrence that a part should be replaced and to have Dell ship the replacement part. Dell will ship parts (freight prepaid) if you use an address in Canada, where applicable. Shipments to other locations will be made freight collect. Dell will include a prepaid shipping container with each replacement part for your use in returning the replaced part to Dell. Replacement parts are new or reconditioned. Dell may provide replacement parts made by various manufacturers when supplying parts to you. The warranty term for a replacement part is the remainder of the limited warranty term.

You will pay Dell for replacement parts if the replaced part is not returned to Dell. The process for returning replaced parts, and your obligation to pay for replacement parts if you do not return the replaced parts to Dell, will be in accordance with Dell's Exchange Policy in effect on the date of the exchange.

You accept full responsibility for your software and data. Dell is not required to advise or remind you of appropriate backup and other procedures.

General Provisions

DELL MAKES NO EXPRESS WARRANTIES OR CONDITIONS BEYOND THOSE STATED IN THIS LIMITED WARRANTY STATEMENT. DELL DISCLAIMS ALL OTHER WARRANTIES AND CONDITIONS, EXPRESS OR IMPLIED, INCLUDING WITHOUT LIMITATION IMPLIED WARRANTIES AND CONDITIONS OF MERCHANTABILITY AND FITNESS FOR A PARTICULAR PURPOSE. SOME STATES (OR JURISDICTIONS) DO NOT ALLOW LIMITATIONS ON IMPLIED WARRANTIES OR CONDITIONS, SO THIS LIMITATION MAY NOT APPLY TO YOU.

DELL'S RESPONSIBILITY FOR MALFUNCTIONS AND DEFECTS IN HARDWARE IS LIMITED TO REPAIR AND REPLACEMENT AS SET

FORTH IN THIS LIMITED WARRANTY STATEMENT. THESE WARRANTIES GIVE YOU SPECIFIC LEGAL RIGHTS, AND YOU MAY ALSO HAVE OTHER RIGHTS, WHICH VARY FROM STATE TO STATE (OR JURISDICTION TO JURISDICTION).

DELL DOES NOT ACCEPT LIABILITY BEYOND THE REMEDIES SET FORTH IN THIS LIMITED WARRANTY STATEMENT OR LIABILITY FOR INCIDENTAL OR CONSEQUENTIAL DAMAGES, INCLUDING WITHOUT LIMITATION ANY LIABILITY FOR PRODUCTS NOT BEING AVAILABLE FOR USE OR FOR LOST DATA OR SOFTWARE.

SOME STATES (OR JURISDICTIONS) DO NOT ALLOW THE EXCLUSION OR LIMITATION OF INCIDENTAL OR CONSEQUENTIAL DAMAGES, SO THE PRECEDING EXCLUSION OR LIMITATION MAY NOT APPLY TO YOU.

These provisions apply to Dell's three-year limited warranty only. For provisions of any service contract covering your system, refer to your invoice or the separate service contract that you will receive.

If Dell elects to exchange a system or component, the exchange will be made in accordance with Dell's Exchange Policy in effect on the date of the exchange. In any instance in which Dell issues a Return Material Authorization Number, Dell must receive the product(s) for repair prior to the expiration of the warranty period in order for the repair(s) to be covered by the limited warranty.

NOTE: If you chose one of the available warranty and service options in place of the standard three-year limited warranty described in the preceding text, the option you chose will be listed on your invoice.

One-Year End-User Manufacturer Guarantee (Latin America and the Caribbean Only)

Guarantee

Dell Computer Corporation ("Dell") warrants to the end user in accordance with the following provisions that its branded hardware products, purchased by the end user from a Dell company or an authorized Dell distributor in Latin America or the Caribbean, will be free from defects in materials, workmanship, and design affecting normal use, for a period of one year from the original purchase date. Products for which proper claims are made will, at Dell's option, be repaired or replaced at Dell's expense. Dell owns all parts removed from repaired products. Dell uses new and reconditioned parts made by various manufacturers in performing repairs and building replacement products.

Exclusions

This Guarantee does not apply to defects resulting from: improper or inadequate installation, use, or maintenance; actions or modifications by unauthorized third parties or the end user; accidental or willful damage; or normal wear and tear.

Making a Claim

Claims must be made in Latin America or the Caribbean by contacting the Dell point of sale within the guarantee period. The end user must always supply proof of purchase, indicating name and address of the seller, date of purchase, model and serial number, name and address of the customer, and details of symptoms and configuration at the time of malfunction, including peripherals and software used. Otherwise, Dell may refuse the guarantee claim. Upon diagnosis of a warranted defect, Dell will make arrangements and pay for ground freight and insurance to and from Dell's repair/replacement center. The end user must ensure that the defective product is available for collection properly packed in original or equally protective packaging together with the details listed above and the return number provided to the end user by Dell.

Limitation and Statutory Rights

Dell makes no other warranty, guarantee or like statement other than as explicitly stated above, and this Guarantee is given in place of all other guarantees whatsoever, to the fullest extent permitted by law. In the absence of applicable legislation, this Guarantee will be the end user's sole and exclusive remedy against Dell or any of its affiliates, and neither Dell nor any of its affiliates shall be liable for loss of profit or contracts, or any other indirect or consequential loss arising from negligence, breach of contract, or howsoever.

This Guarantee does not impair or affect mandatory statutory rights of the end-user against and/or any rights resulting from other contracts concluded by the end-user with Dell and/or any other seller.

Dell World Trade LP

One Dell Way, Round Rock, TX 78682, USA

Dell Computadores do Brasil Ltda (CNPJ No. 72.381.189/0001-10)/

Dell Commercial do Brasil Ltda (CNPJ No. 03 405 822/0001-40)

Avenida Industrial Belgraf, 400
92990-000 - Eldorado do Sul – RS - Brasil

Dell Computer de Chile Ltda

Coyancura 2283, Piso 3- Of.302,
Providencia, Santiago - Chile

Dell Computer de Colombia Corporation

Carrera 7 #115-33 Oficina 603
Bogota, Colombia

Dell Computer de Mexico SA de CV

Paseo de la Reforma 2620 - 11° Piso
Col. Lomas Altas
11950 México, D.F.

"Total Satisfaction" Return Policy (U.S. and Canada Only)

If you are an end-user customer who bought new products directly from a Dell company, you may return them to Dell within 30 days of the date of invoice for a refund or credit of the product purchase price. If you are an end-user customer who bought reconditioned or refurbished products from a Dell company, you may return them to Dell within 14 days of the date of invoice for a refund or credit of the product purchase price. In either case, the refund or credit will not include any shipping and handling charges shown on your invoice. If you are an organization that bought the products under a written agreement with Dell, the agreement may contain different terms for the return of products than specified by this policy.

To return products, you must contact Dell Customer Service to receive a Credit Return Authorization Number. See "[Contacting Dell](#)" to find the appropriate contact information for obtaining customer assistance. To expedite the processing of your refund or credit, Dell expects you to return the products to Dell in their original packaging within five days of the date that Dell issues the Credit Return Authorization Number. You must also prepay shipping charges and insure the shipment or accept the risk of loss or damage during shipment. You may return software for refund or credit only if the sealed package containing the floppy disk(s) or CD(s) is unopened. Returned products must be in as-new condition, and all of the manuals, floppy disk(s), CD(s), power cables, and other items included with a product must be returned with it. For customers who want to return, for refund or credit only, either applications software or an operating system that has been installed by Dell, the whole system must be returned, along with any media and documentation that may have been included in the original shipment.

This "Total Satisfaction" Return Policy does not apply to DellWare products, which may be returned under DellWare's then-current return policy. In addition, reconditioned parts purchased through Dell Spare Parts Sales in Canada are nonreturnable.

[Back to Contents Page](#)