



Dell™ Latitude™ 131L Service Manual

[Before You Begin](#)
[Optical Drive](#)
[Hard Drive](#)
[Memory Module\(s\)](#)
[Modem](#)
[Mini-Card](#)
[Hinge Cover](#)
[Keyboard](#)
[Display Assembly](#)
[Palm Rest](#)

[Coin-Cell Battery](#)
[Speakers](#)
[Processor Thermal-Cooling Assembly](#)
[Processor Module](#)
[Fan](#)
[ExpressCard/Hard-Drive Bay Assembly](#)
[System Board](#)
[Battery Latch Assembly](#)
[Flashing the BIOS](#)
[Pin Assignments for I/O Connectors](#)

Notes, Notices, and Cautions

-  **NOTE:** A NOTE indicates important information that helps you make better use of your computer.
-  **NOTICE:** A NOTICE indicates either potential damage to hardware or loss of data and tells you how to avoid the problem.
-  **CAUTION:** A CAUTION indicates a potential for property damage, personal injury, or death.

Abbreviations and Acronyms

For a complete list of abbreviations and acronyms, see "Glossary" in the *User's Guide*.

If you purchased a Dell™ n Series computer, any references in this document to Microsoft® Windows® operating systems are not applicable.

Information in this document is subject to change without notice.
© 2006 Dell Inc. All rights reserved.

Reproduction in any manner whatsoever without the written permission of Dell Inc. is strictly forbidden.

Trademarks used in this text: *Dell*, the *DELL* logo, and *Inspiron* are trademarks of Dell Inc.; *Microsoft* and *Windows* are registered trademarks of Microsoft Corporation.

Other trademarks and trade names may be used in this document to refer to either the entities claiming the marks and names or their products. Dell Inc. disclaims any proprietary interest in trademarks and trade names other than its own.

Model PP23LB

October 2006 Rev. A00

Battery Latch Assembly

Dell™ Latitude™ 131L Service Manual

- [Removing the Battery Latch Assembly](#)
- [Replacing the Battery Latch Assembly](#)

⚠ CAUTION: Before you begin the following procedure, follow the safety instructions in the *Product Information Guide*.

➡ NOTICE: To avoid electrostatic discharge, ground yourself by using a wrist grounding strap or by periodically touching an unpainted metal surface (such as the back panel) on the computer.

➡ NOTICE: To help prevent damage to the system board, remove the main battery (see [Before Working Inside Your Computer](#)) before working inside the computer.

Removing the Battery Latch Assembly

1. Follow the instructions in [Before You Begin](#).
2. Remove the hard drive (see [Removing the Hard Drive](#)).
3. Remove the hinge cover (see [Removing the Hinge Cover](#)).
4. Remove the keyboard (see [Removing the Keyboard](#)).
5. Remove the display assembly (see [Removing the Display Assembly](#)).
6. Remove the palm rest (see [Removing the Palm Rest](#)).
7. Remove the processor thermal-cooling assembly (see [Removing the Processor Thermal-Cooling Assembly](#)).
8. Remove the system board (see [Removing the System Board](#)).
9. Remove the M2 x 2.7-mm screw from the battery latch assembly.

When you remove the M2 x 2.7-mm screw, the battery latch release on the bottom of the computer will also be removed.

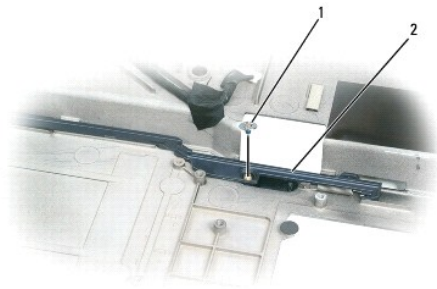

1	M2 x 2.7-mm screw	2	battery latch assembly
---	-------------------	---	------------------------

10. Remove the spring from the hook on the computer base by lifting it away with a screwdriver or a plastic scribe.

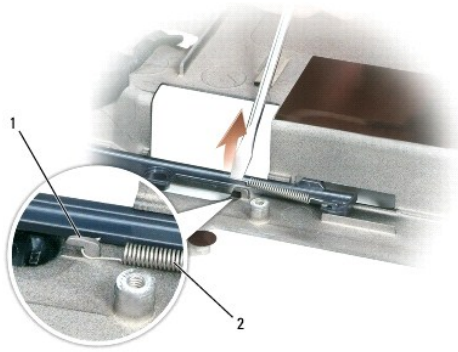

1	hook	2	spring
---	------	---	--------

11. Remove the plastic battery-latch assembly by twisting the assembly slightly and lifting it out of the channel and away from the computer base.

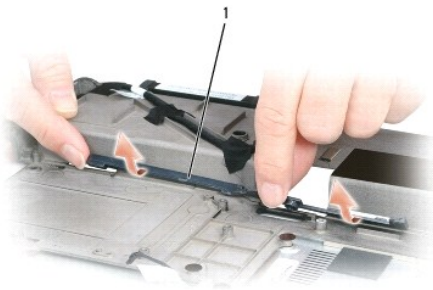

1	battery latch assembly
---	------------------------

Replacing the Battery Latch Assembly

1. Insert the latch assembly into the channel on the computer base, and press it into place.
2. Using a small screwdriver, hook the spring over the hook on the computer base.
3. Place the battery latch release under the computer base, line it up with the hole in the base, and then replace the screw in the assembly.
Ensure that the newly installed latch moves smoothly and freely when pushed and released.
4. Replace the system board (see [Replacing the System Board](#)).
5. Replace the processor thermal-cooling assembly (see [Replacing the Processor Thermal-Cooling Assembly](#)).
6. Replace the palm rest (see [Replacing the Palm Rest](#)).
7. Replace the display assembly (see [Replacing the Display Assembly](#)).
8. Replace the keyboard (see [Replacing the Keyboard](#)).
9. Replace the hinge cover (see [Replacing the Hinge Cover](#)).
10. Replace the hard drive (see [Replacing the Hard Drive](#)).

[Back to Contents Page](#)

Before You Begin

Dell™ Latitude™ 131L Service Manual

- [Recommended Tools](#)
- [Turning Off Your Computer](#)
- [Before Working Inside Your Computer](#)

This section provides procedures for removing and installing the components in your computer. Unless otherwise noted, each procedure assumes that the following conditions exist:

- 1 You have performed the steps in [Turning Off Your Computer](#) and [Before Working Inside Your Computer](#).
- 1 You have read the safety information in the Dell™ *Product Information Guide*.
- 1 A component can be replaced or—if purchased separately—installed by performing the removal procedure in reverse order.

Recommended Tools

The procedures in this document may require the following tools:

- 1 Small flat-blade screwdriver
- 1 Phillips screwdriver
- 1 Small plastic scribe
- 1 Hex-nut driver
- 1 Flash BIOS update program CD

Turning Off Your Computer

 **NOTICE:** To avoid losing data, save and close any open files and exit any open programs before you turn off your computer.

1. Shut down the operating system:

Save and close any open files, exit any open programs, click **Start** → **Shut Down** → **Shut down**.

The computer turns off after the operating system shutdown process finishes.

2. Ensure that the computer and any attached devices are turned off. If your computer and attached devices did not automatically turn off when you shut down your operating system, press and hold the power button until the computer turns off.

Before Working Inside Your Computer

Use the following safety guidelines to help protect your computer from potential damage and to help ensure your own personal safety.

 **CAUTION:** Before you begin any of the procedures in this section, follow the safety instructions in the *Product Information Guide*.

 **NOTICE:** Handle components and cards with care. Do not touch the components or contacts on a card. Hold a card by its edges or by its metal mounting bracket. Hold a component such as a processor by its edges, not by its pins.

 **NOTICE:** Only a certified service technician should perform repairs on your computer. Damage due to servicing that is not authorized by Dell is not covered by your warranty.

 **NOTICE:** When you disconnect a cable, pull on its connector or on its pull-tab, not on the cable itself. Some cables have a connector with locking tabs; if you are disconnecting this type of cable, press in on the locking tabs before you disconnect the cable. As you pull connectors apart, keep them evenly aligned to avoid bending any connector pins. Also, before you connect a cable, ensure that both connectors are correctly oriented and aligned.

 **NOTICE:** To help prevent damage to the computer, perform the following steps before you begin working inside the computer.

1. Ensure that the work surface is flat and clean to prevent the computer cover from being scratched.
2. Turn off your computer (see [Turning Off Your Computer](#)).

 **NOTICE:** To disconnect a network cable, first unplug the cable from your computer and then unplug it from the network device.

3. Disconnect any telephone or network cables from the computer.

4. Disconnect your computer and all attached devices from their electrical outlets.

5. Close the display and turn the computer upside-down on a flat work surface.

🔔 **NOTICE:** To help prevent damage to the system board, remove the main battery before working inside the computer.

6. Slide the battery-bay latch release on the bottom of the computer.

7. Remove the battery from the battery bay.



1	battery-bay latch release	2	main battery
---	---------------------------	---	--------------

[Back to Contents Page](#)

[Back to Contents Page](#)

Flashing the BIOS

Dell™ Latitude™ 131L Service Manual

1. Ensure that the AC adapter is plugged in and that the main battery is installed properly.

 **NOTE:** If you use a BIOS update program CD to flash the BIOS, set up the computer to boot from a CD before inserting the CD. The BIOS update program CD may not be available in your region.

2. Insert the BIOS update program CD, and turn on the computer.

Follow the instructions that appear on the screen. The computer continues to boot and updates the new BIOS. When the flash update is complete, the computer will automatically reboot.



3. Press <F2> during POST to enter the system setup program.
4. Press <Esc Suspend>, select **Save changes and reboot**, and press <Enter> to save configuration changes.
5. Remove the flash BIOS update program floppy or CD from the drive and restart the computer.

[Back to Contents Page](#)

Dell™ Latitude™ 131L Service Manual

[Before You Begin](#)
[Optical Drive](#)
[Hard Drive](#)
[Memory Module\(s\)](#)
[Modem](#)
[Mini-Card](#)
[Hinge Cover](#)
[Keyboard](#)
[Display Assembly](#)
[Palm Rest](#)
[Coin-Cell Battery](#)
[Speakers](#)
[Processor Thermal-Cooling Assembly](#)
[Processor Module](#)
[Fan](#)
[ExpressCard/Hard-Drive Bay Assembly](#)
[System Board](#)
[Battery Latch Assembly](#)
[Flashing the BIOS](#)
[Pin Assignments for I/O Connectors](#)

Notes, Notices, and Cautions

-  **NOTE:** A NOTE indicates important information that helps you make better use of your computer.
-  **NOTICE:** A NOTICE indicates either potential damage to hardware or loss of data and tells you how to avoid the problem.
-  **CAUTION:** A CAUTION indicates a potential for property damage, personal injury, or death.

Abbreviations and Acronyms

For a complete list of abbreviations and acronyms, see "Glossary" in the *User's Guide*.

If you purchased a Dell™ n Series computer, any references in this document to Microsoft® Windows® operating systems are not applicable.

Information in this document is subject to change without notice.
© 2006 Dell Inc. All rights reserved.

Reproduction in any manner whatsoever without the written permission of Dell Inc. is strictly forbidden.

Trademarks used in this text: *Dell*, the *DELL* logo, and *Inspiron* are trademarks of Dell Inc.; *Microsoft* and *Windows* are registered trademarks of Microsoft Corporation.

Other trademarks and trade names may be used in this document to refer to either the entities claiming the marks and names or their products. Dell Inc. disclaims any proprietary interest in trademarks and trade names other than its own.

Model PP23LB

October 2006 Rev. A00

ExpressCard/Hard-Drive Bay Assembly

Dell™ Latitude™ 131L Service Manual

- [Removing the ExpressCard/Hard-Drive Bay Assembly](#)
- [Replacing the ExpressCard/Hard-Drive Bay Assembly](#)

⚠ CAUTION: Before you begin the following procedure, follow the safety instructions in the *Product Information Guide*.

🔧 NOTICE: To avoid electrostatic discharge, ground yourself by using a wrist grounding strap or by periodically touching an unpainted metal surface (such as the back panel) on the computer.

🔧 NOTICE: To help prevent damage to the system board, remove the main battery (see [Before Working Inside Your Computer](#)) before working inside the computer.

Removing the ExpressCard/Hard-Drive Bay Assembly

1. Follow the instructions in [Before You Begin](#).
2. Remove the hard drive (see [Removing the Hard Drive](#)).
3. Remove the optical drive (see [Removing an Optical Drive](#)).
4. Remove the hinge cover (see [Removing the Hinge Cover](#)).
5. Remove the keyboard (see [Removing the Keyboard](#)).
6. Remove the display assembly (see [Removing the Display Assembly](#)).
7. Remove the palm rest (see [Removing the Palm Rest](#)).
8. Remove the six M2.5x 5-mm screws from the ExpressCard/hard-drive bay assembly.

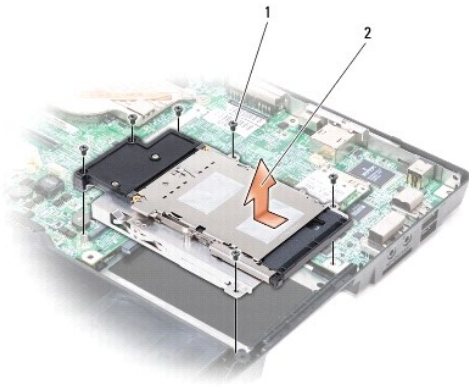

1	M2.5 x 5-mm screws (6)	2	ExpressCard/hard-drive bay assembly
---	------------------------	---	-------------------------------------

9. Remove the assembly from the system board.
-

Replacing the ExpressCard/Hard-Drive Bay Assembly

1. At a 45-degree angle, insert the end of the ExpressCard/hard-drive bay assembly into its access hole on the side of the computer base.
 2. Lower the assembly aligning the screw holes on the assembly with the holes on the system board.
 3. Replace the six M2.5x 5-mm screws from the assembly.
-

[Back to Contents Page](#)

[Back to Contents Page](#)

Mini-Card

Dell™ Latitude™ 131L Service Manual

- [Removing a Mini-Card](#)
- [Replacing a Mini-Card](#)

If you ordered a Mini-Card with your computer, the card is already installed.

⚠ CAUTION: Before you begin any of the procedures in this section, follow the safety instructions in the **Product Information Guide**.

🔧 NOTICE: To avoid electrostatic discharge, ground yourself by using a wrist grounding strap or by periodically touching an unpainted metal surface (such as the back panel) on the computer.

🔧 NOTICE: To help prevent damage to the system board, you must remove the battery from the battery bay before you begin working inside the computer.

Removing a Mini-Card

1. Follow the procedures in [Before You Begin](#).
2. Remove the hinge cover (see [Removing the Hinge Cover](#)).
3. Remove the keyboard (see [Removing the Keyboard](#)).
4. Disconnect the two antenna cables from the Mini-Card.



1	Mini-Card	2	antenna cables (2)
---	-----------	---	--------------------

5. Release the Mini-Card by pushing the metal securing tabs toward the back of the computer until the card pops up slightly.
6. Lift the Mini-Card out of its system board connector.



1	metal securing tab	2	Mini-Card	3	metal securing tab
---	--------------------	---	-----------	---	--------------------

Replacing a Mini-Card

- ➔ **NOTICE:** The system board and Mini-Card connectors are keyed to ensure correct insertion. If you feel resistance, check the connectors on the card and on the system board, and realign the card.
- ➔ **NOTICE:** Make sure the antenna cables are not under the card when you insert it.

1. Insert the Mini-Card connector into the system board connector at a 45-degree angle.



2. Press the other end of the Mini-Card into the securing tabs until the card clicks into place.
3. Connect the black antenna cable to the connector labeled with a black triangle, and connect the white antenna cable to the connector labeled with a white triangle.



1	Mini-Card	2	white antenna cable (white triangle)	3	black antenna cable (black triangle)
---	-----------	---	--------------------------------------	---	--------------------------------------

[Back to Contents Page](#)

[Back to Contents Page](#)

Coin-Cell Battery

Dell™ Latitude™ 131L Service Manual

- [Removing the Coin-Cell Battery](#)
- [Replacing the Coin-Cell Battery](#)

⚠ CAUTION: Before you begin the following procedure, follow the safety instructions in the *Product Information Guide*.

👉 NOTICE: To avoid electrostatic discharge, ground yourself by using a wrist grounding strap or by periodically touching an unpainted metal surface (such as the back panel) on the computer.

👉 NOTICE: To help prevent damage to the system board, remove the main battery (see [Before Working Inside Your Computer](#)) before working inside the computer.

Removing the Coin-Cell Battery

1. Follow the instructions in [Before You Begin](#).
2. Remove the hinge cover (see [Removing the Hinge Cover](#)).
3. Remove the keyboard (see [Removing the Keyboard](#)).
4. Insert a plastic scribe into the guide on the side of the coin-cell battery compartment, and pry out the battery.



Replacing the Coin-Cell Battery

1. When you replace the battery, insert it at a 30-degree angle under the clip with the positive (identified by a plus [+] symbol) side up, and then push it into place.
 2. Replace the keyboard (see [Replacing the Keyboard](#)).
 3. Replace the hinge cover (see [Replacing the Hinge Cover](#)).
-

[Back to Contents Page](#)

Processor Module

Dell™ Latitude™ 131L Service Manual

- [Removing the Processor Module](#)
- [Replacing the Processor Module](#)

⚠ CAUTION: Before you begin the following procedure, follow the safety instructions in the *Product Information Guide*.

- ➡ **NOTICE:** To avoid electrostatic discharge, ground yourself by using a wrist grounding strap or by periodically touching an unpainted metal surface (such as the back panel) on the computer.
- ➡ **NOTICE:** Do not touch the processor die. Press and hold the processor down on the substrate on which the die is mounted while turning the cam screw to prevent intermittent contact between the cam screw and processor.
- ➡ **NOTICE:** To avoid damage to the processor, hold the screwdriver so that it is perpendicular to the processor when turning the cam screw.
- ➡ **NOTICE:** To help prevent damage to the system board, remove the main battery (see [Before Working Inside Your Computer](#)) before working inside the computer.

Removing the Processor Module

1. Follow the instructions in [Before You Begin](#).
2. Remove the hinge cover (see [Removing the Hinge Cover](#)).
3. Remove the keyboard (see [Removing the Keyboard](#)).
4. Remove the display assembly (see [Removing the Display Assembly](#)).
5. Remove the palm rest (see [Removing the Palm Rest](#)).
- ➡ **NOTICE:** To ensure maximum cooling for the processor, do not touch the heat transfer areas on the processor thermal-cooling assembly. The oils in your skin reduce the heat transfer capability of the thermal pads.
6. Remove the processor thermal-cooling assembly (see [Removing the Processor Thermal-Cooling Assembly](#)).
- ➡ **NOTICE:** When removing the processor module, pull the module straight up. Be careful not to bend the pins on the processor module.
7. To loosen the ZIF socket, use a small, flat-blade screwdriver and rotate the ZIF-socket cam screw counterclockwise until it comes to the cam stop.





1	ZIF-socket cam screw	2	microprocessor	3	pin-1 corner of microprocessor
---	----------------------	---	----------------	---	--------------------------------

🔍 NOTE: The ZIF-socket cam screw secures the processor to the system board. Take note of the arrow on the ZIF-socket cam screw, which indicates the direction to turn the cam screw.

8. Lift the processor module from the ZIF socket.

Replacing the Processor Module

 **NOTICE:** Ensure that the cam lock is in the fully open position before seating the processor module. Seating the processor module properly in the ZIF socket does not require force.

 **NOTICE:** A processor module that is not properly seated can result in an intermittent connection or permanent damage to the processor and ZIF socket.

 **NOTE:** If you have ordered a new microprocessor, you will receive one of the following: a new thermal-cooling assembly which will include an affixed thermal pad; or, you will receive a new thermal pad along with a tech sheet to illustrate proper installation.

1. Align the pin-1 corner of the processor module with the pin-1 corner of the ZIF socket, and insert the processor module.

 **NOTE:** The pin-1 corner of the processor module has a triangle that aligns with the triangle on the pin-1 corner of the ZIF socket.

 **NOTICE:** You must position the processor module correctly in the ZIF socket to avoid permanent damage to the module and the socket.

When the processor module is correctly seated, all four corners are aligned at the same height. If one or more corners of the module are higher than the others, the module is not seated correctly.

2. Tighten the ZIF socket by turning the cam screw clockwise to secure the processor module to the system board.
3. Replace the palm rest (see [Replacing the Palm Rest](#)).
4. Replace the display assembly (see [Replacing the Display Assembly](#)).
5. Replace the keyboard (see [Replacing the Keyboard](#)).
6. Replace the hinge cover (see [Replacing the Hinge Cover](#)).

[Back to Contents Page](#)

Processor Thermal-Cooling Assembly

Dell™ Latitude™ 131L Service Manual

- [Removing the Processor Thermal-Cooling Assembly](#)
- [Replacing the Processor Thermal-Cooling Assembly](#)

⚠ CAUTION: Before you begin the following procedure, follow the safety instructions in the *Product Information Guide*.

➡ NOTICE: To avoid electrostatic discharge, ground yourself by using a wrist grounding strap or by periodically touching an unpainted metal surface (such as the back panel) on the computer.

➡ NOTICE: To help prevent damage to the system board, remove the main battery (see [Before Working Inside Your Computer](#)) before working inside the computer.

Removing the Processor Thermal-Cooling Assembly

1. Follow the instructions in [Before You Begin](#).
2. Remove the hinge cover (see [Removing the Hinge Cover](#)).
3. Remove the keyboard (see [Removing the Keyboard](#)).
4. Remove the display assembly (see [Removing the Display Assembly](#)).
5. Remove the palm rest (see [Removing the Palm Rest](#)).
6. Loosen in consecutive order the four captive screws, labeled "1" through "4," that secure the processor thermal-cooling assembly to the system board.

➡ NOTICE: To ensure maximum cooling for the processor, do not touch the heat transfer areas on the processor thermal-cooling assembly. The oils in your skin reduce the heat transfer capability of the thermal pads.

7. Lift the processor thermal-cooling assembly and remove it from the system board.

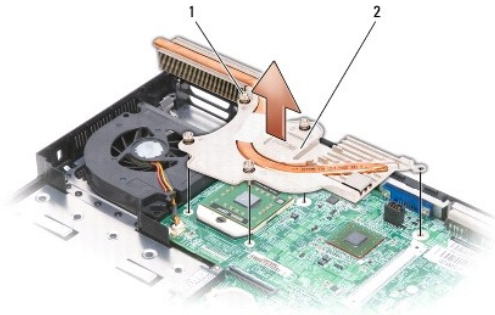

1	captive screws (4)	2	processor thermal-cooling assembly
---	--------------------	---	------------------------------------

Replacing the Processor Thermal-Cooling Assembly

🔧 NOTE: If you are replacing the thermal-cooling assembly without removing and replacing a new processor, you can place the new thermal pad directly on any existing thermal pad already installed on the thermal-cooling assembly. It is not necessary to remove an existing pad or to clean the surface.

1. Place the processor thermal-cooling assembly over the processor.
2. Tighten the four captive screws, labeled "1" through "4," in consecutive order.

Display Assembly

Dell™ Latitude™ 131L Service Manual

- [Removing the Display Assembly](#)
- [Replacing the Display Assembly](#)
- [Display Bezel](#)
- [Display Panel](#)
- [Display Latch](#)

CAUTION: Before you begin the following procedure, follow the safety instructions in the *Product Information Guide*.

NOTICE: To avoid electrostatic discharge, ground yourself by using a wrist grounding strap or by periodically touching an unpainted metal surface (such as the back panel) on the computer.

NOTICE: To help prevent damage to the system board, remove the main battery (see [Before Working Inside Your Computer](#)) before working inside the computer.

Removing the Display Assembly

1. Follow the instructions in [Before You Begin](#).
2. Remove the hinge cover (see [Removing the Hinge Cover](#)).
3. Remove the keyboard (see [Removing the Keyboard](#)).
4. Close the display and turn the computer upside down.
5. Remove the two M2.5 x 8-mm screws that hold the display to the bottom of the computer.

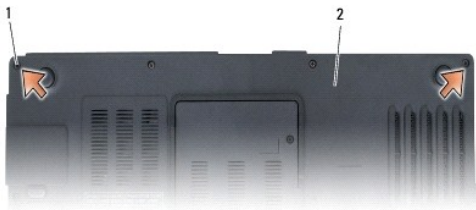

1	M2.5 x 8-mm screws (2)	2	bottom of computer
---	------------------------	---	--------------------

6. Remove the two screw covers from the back of the computer; then, remove the two M2.5 x 8-mm screws from the back of the computer.



1	M2.5 x 8-mm screws (2)	2	back of computer
---	------------------------	---	------------------

7. Turn the computer over and open the display.
8. Remove the two M2.5 x 5-mm screws on the display hinge.
9. Disconnect the antenna cables from the Mini-Card and dislodge the cables from the antenna cable channel.
10. Loosen the captive grounding-wire screw and dislodge the display cable from the display cable channel.
11. Pull the pull-tab straight up to disconnect the display cable from the system board.

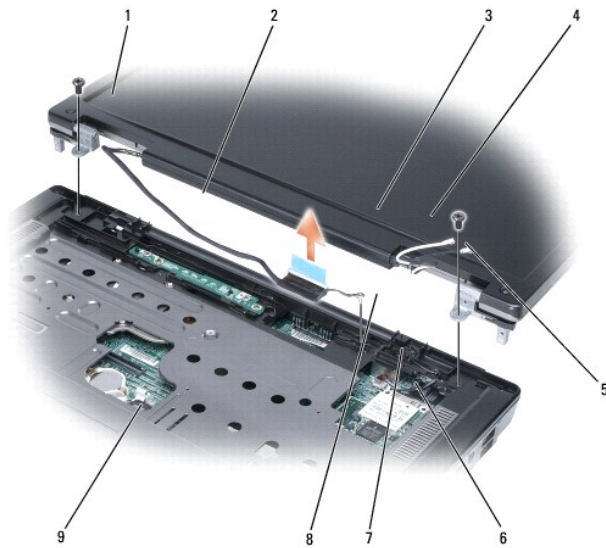

1	M2.5 x 5-mm screws (2)	2	display cable	3	display cable pull-tab
4	grounding-wire and captive screw	5	antenna cables (2)	6	antenna cable channel
7	standby switch	8	display cable connector on system board	9	display cable channel

12. Lift the display up and away from the computer.

 **NOTICE:** The standby switch is fragile and easily broken. Avoid knocking the switch when removing and replacing the display.

Replacing the Display Assembly

 **NOTE:** Ensure the display and antenna cables are not twisted and are clear of the computer base before replacing the display.

1. Place the display onto the computer base.
2. Replace the two M2.5 x 5-mm screws in the display hinge.
3. Securely route the display cable under the tabs in the cable channel.
4. Connect the display cable to the system board and tighten the captive screw.
5. Securely route the antenna cables under the tabs in the antenna cable channel. If a Mini-Card is installed, connect the antenna cables to the card (see [Replacing a Mini-Card](#)).
6. Replace the keyboard (see [Replacing the Keyboard](#)).
7. Replace the hinge cover (see [Replacing the Hinge Cover](#)).
8. Close the display.
9. Replace the two M2.5 x 8-mm screws in the back of the computer and replace the two screw covers.
10. Turn the computer over and replace the two M2.5 x 8-mm screws in the bottom of the computer.

Display Bezel

 **CAUTION:** Before you begin the following procedure, follow the safety instructions in the *Product Information Guide*.

- ➔ **NOTICE:** To avoid electrostatic discharge, ground yourself by using a wrist grounding strap or by periodically touching an unpainted metal surface (such as the back panel) on the computer.
- ➔ **NOTICE:** To help prevent damage to the system board, you must remove the main battery (see [Before Working Inside Your Computer](#)) before you begin working inside the computer.

Removing the Display Bezel

1. Follow the instructions in [Before You Begin](#).
2. Remove the display assembly (see [Removing the Display Assembly](#)).
3. Remove the six rubber display bumpers.
4. Remove the six M2.5 x 4.2-mm screws around the display bezel.



1	rubber display bumpers (6)	2	M2.5 x 4.2-mm screws (6)	3	display bezel
---	----------------------------	---	--------------------------	---	---------------

- ➔ **NOTICE:** Removal of the bezel from the display back cover requires extreme care to avoid damage to the bezel.

5. Starting above the DELL™ logo on the display bezel, use your fingers to gently pull up on the bezel and pry it away from the display assembly. Working your way around the display, continue to carefully pry up the bezel until you clear all sides of the display assembly.



1	display bezel	2	display panel
---	---------------	---	---------------

Replacing the Display Bezel

1. Starting at any corner, use your fingers to gently snap the bezel into place to secure it to the display assembly.
2. Replace the six M2.5 x 4.2-mm screws around the display bezel.

3. Replace the six rubber display bumpers around the display bezel.

Display Panel

⚠ CAUTION: Before you begin the following procedure, follow the safety instructions in the *Product Information Guide*.

- 👉 **NOTICE:** To avoid electrostatic discharge, ground yourself by using a wrist grounding strap or by touching an unpainted metal surface on the computer.
- 👉 **NOTICE:** To help prevent damage to the system board, you must remove the main battery (see [Before Working Inside Your Computer](#)) before you begin working inside the computer.

Removing the Display Panel

1. Follow the instructions in [Before You Begin](#).
2. Remove the display assembly (see [Removing the Display Assembly](#)).
3. Remove the display bezel (see [Removing the Display Bezel](#)).
4. Remove the eight M2 x 3-mm screws (four on each side of the display panel).
5. Lift the display panel out of the display back cover.

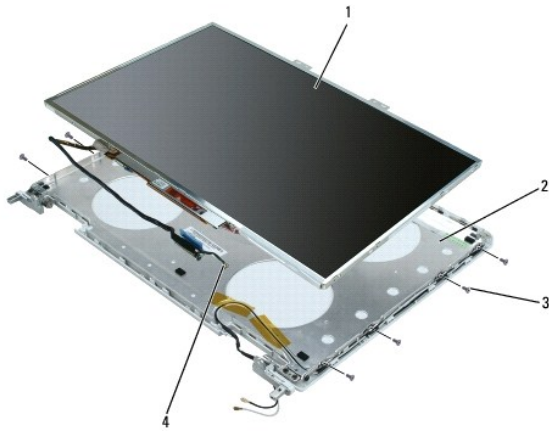

1	display panel	2	display back cover	3	M2 x 3-mm screws (8)
4	grounding wire and captive screw				

6. Press in both sides of the top flex-cable connector, and pull the top flex-cable connector away from the display connector.
7. Pull straight up on the pull-tab to disconnect the bottom flex-cable connector from the inverter connector.

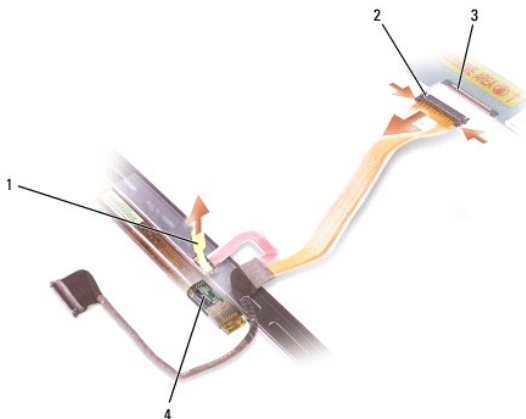

1	pull-tab on bottom flex-cable connector	2	top flex-cable connector	3	display cable connector
4	inverter connector				

Replacing the Display Panel

1. Reconnect the top display-cable connector to the top flex-cable connector.
2. Reconnect the bottom flex-cable connector to the inverter connector.
3. Replace the display panel inside the display back cover.

 **NOTE:** The eight screw locations are numbered. Replace the screws in sequential order.

4. Replace the eight M2 x 3-mm screws (four on each side) in order around the display panel.
5. Replace the display bezel (see [Replacing the Display Bezel](#)).

Display Latch

 **CAUTION:** Before you begin the following procedure, follow the safety instructions in the *Product Information Guide*.

 **NOTICE:** To avoid electrostatic discharge, ground yourself by using a wrist grounding strap or by touching an unpainted metal surface on the computer.

 **NOTICE:** To help prevent damage to the system board, you must remove the main battery (see [Before Working Inside Your Computer](#)) before you begin working inside the computer.

Removing the Display Latch

1. Follow the instructions in [Before You Begin](#).
2. Remove the display assembly (see [Removing the Display Assembly](#)).
3. Remove the display bezel (see [Removing the Display Bezel](#)).
4. Slide the latch to the right and gently lift.
5. Remove the spring that attaches the latch to the display panel.

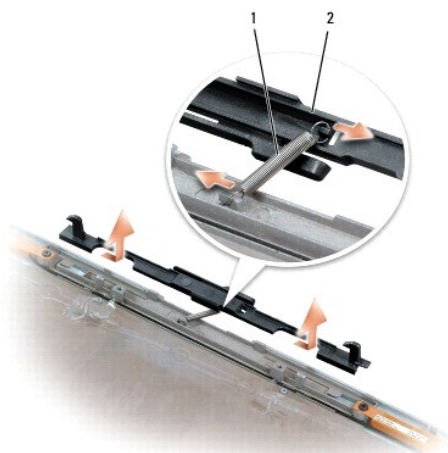

1	spring	2	display latch
---	--------	---	---------------

Replacing the Display Latch

1. Replace the spring that attaches the latch to the display panel.
2. Align the latch with the display panel and slide the latch to the left to secure it into place.

[Back to Contents Page](#)

Fan

Dell™ Latitude™ 131L Service Manual

- [Removing a Fan](#)
- [Replacing a Fan](#)

⚠ CAUTION: Before you begin the following procedure, follow the safety instructions in the *Product Information Guide*.

🔌 NOTICE: To avoid electrostatic discharge, ground yourself by using a wrist grounding strap or by periodically touching an unpainted metal surface (such as the back panel) on the computer.

🔌 NOTICE: To help prevent damage to the system board, remove the main battery (see [Before Working Inside Your Computer](#)) before working inside the computer.

Removing a Fan

1. Follow the instructions in [Before You Begin](#).
2. Remove the hinge cover (see [Removing the Hinge Cover](#)).
3. Remove the keyboard (see [Removing the Keyboard](#)).
4. Remove the display assembly (see [Removing the Display Assembly](#)).
5. Remove the palm rest (see [Removing the Palm Rest](#)).
6. Remove the two M2.5 x 5-mm screws from the fan.
7. Disconnect the fan connector from the connector on the system board.

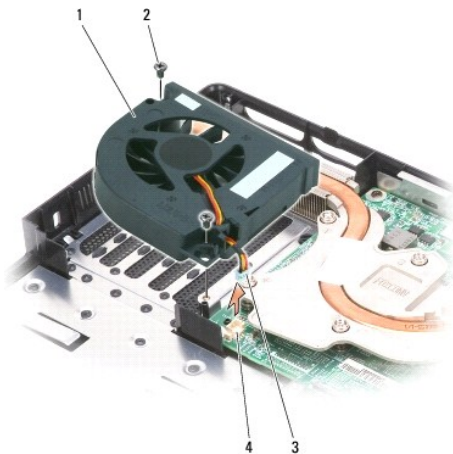

1	fan	2	M2.5 x 5-mm screws (2)	3	fan cable connector
4	fan system board connector				

Replacing a Fan

1. Connect the fan connector to the connector on the system board.
2. Replace the two M2.5 x 5-mm screws in the fan.
3. Replace the display assembly (see [Replacing the Display Assembly](#)).
4. Replace the palm rest (see [Replacing the Palm Rest](#)).

5. Replace the keyboard (see [Replacing the Keyboard](#)).
6. Replace the hinge cover (see [Replacing the Hinge Cover](#)).

[Back to Contents Page](#)

Hard Drive

Dell™ Latitude™ 131L Service Manual

- [Removing the Hard Drive](#)
- [Replacing the Hard Drive](#)

- ⚠ **CAUTION:** If you remove the hard drive from the computer when the drive is hot, *do not touch* the metal housing of the hard drive.
 - ⚠ **CAUTION:** Before you begin the following procedure, follow the safety instructions in the *Product Information Guide*.
 - ➡ **NOTICE:** To help prevent damage to the system board, remove the main battery (see [Before Working Inside Your Computer](#)) before working inside the computer.
 - ➡ **NOTICE:** To prevent data loss, turn off your computer before removing the hard drive. Do not remove the hard drive while the computer is on, in standby mode, or in hibernate mode.
 - ➡ **NOTICE:** Hard drives are extremely fragile: even a slight bump can damage the drive.
 - 📌 **NOTE:** Dell does not guarantee compatibility or provide support for hard drives from sources other than Dell.
-

Removing the Hard Drive

1. Follow the instructions in [Before You Begin](#).
2. Turn the computer upside-down and remove the two M3 x 3-mm screws.

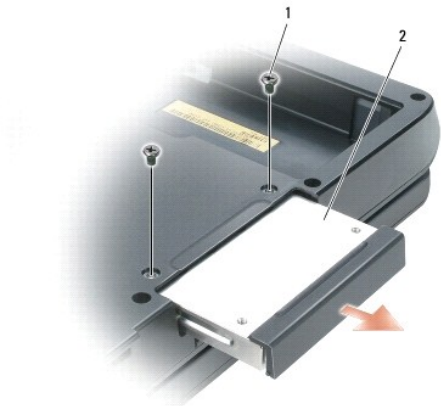

1	M3 x 3-mm screws (2)	2	hard drive
---	----------------------	---	------------

- ➡ **NOTICE:** When the hard drive is not in the computer, store it in protective antistatic packaging. See "Protecting Against Electrostatic Discharge" in your *Product Information Guide*.

3. Slide the hard drive out of the computer.
-

Replacing the Hard Drive

- ➡ **NOTICE:** Use firm and even pressure to slide the drive into place. If you use excessive force, you may damage the connector.

1. Slide the drive into the bay until it is fully seated.
 2. Replace and tighten the screws.
 3. If you have installed a replacement hard drive, reinstall the Microsoft® Windows® operating system. For instructions, see "Restoring Your Operating System" in the *User's Guide*.
 4. Reinstall drivers on the new hard drive. For instructions, see "Reinstalling Drivers and Utilities" in the *User's Guide*.
-

[Back to Contents Page](#)

Hinge Cover

Dell™ Latitude™ 131L Service Manual

- [Removing the Hinge Cover](#)
- [Replacing the Hinge Cover](#)

⚠ CAUTION: Before you begin the following procedure, follow the safety instructions in the *Product Information Guide*.

➡ NOTICE: To avoid electrostatic discharge, ground yourself by using a wrist grounding strap or by periodically touching an unpainted metal surface (such as the back panel) on the computer.

➡ NOTICE: To help prevent damage to the system board, remove the main battery (see [Before Working Inside Your Computer](#)) before working inside the computer.

➡ NOTICE: The hinge cover is fragile and can be damaged if extreme force is used. Be careful when removing the hinge cover.

Removing the Hinge Cover

1. Follow the instructions in [Before You Begin](#).

➡ NOTICE: To help avoid damage to the hinge cover, ensure that it is snapped securely into place before you rotate the display open to 180 degrees.

2. Open the display all the way (180 degrees) so that it lies flat against your work surface.
3. Using a small scribe, insert the scribe on the right side of the hinge cover to gently pry the hinge cover loose.
4. Pulling up from right to left, gently remove the hinge cover.



1	hinge cover	2	scribe
---	-------------	---	--------

Replacing the Hinge Cover

With the display open all the way (180 degrees) so that it lies flat against the work surface, snap the cover back into place, starting from left to right.

Keyboard

Dell™ Latitude™ 131L Service Manual

- [Removing the Keyboard](#)
- [Replacing the Keyboard](#)

⚠ CAUTION: Before you begin the following procedure, follow the safety instructions in the *Product Information Guide*.

➡ NOTICE: To avoid electrostatic discharge, ground yourself by using a wrist grounding strap or by periodically touching an unpainted metal surface (such as the back panel) on the computer.

➡ NOTICE: To help prevent damage to the system board, remove the main battery (see [Before Working Inside Your Computer](#)) before working inside the computer.

Removing the Keyboard

1. Follow the procedures in [Before You Begin](#).
 2. Open the display.
 3. Remove the hinge cover (see [Removing the Hinge Cover](#)).
 4. Remove the two M2.5 x 5-mm screws at the top of the keyboard.
- ➡ NOTICE:** The keycaps on the keyboard are fragile, easily dislodged, and time-consuming to replace. Be careful when removing and handling the keyboard.
5. Lift the keyboard and hold it up and slightly forward to provide access to the keyboard connector.
 6. To disconnect the keyboard cable, lift the connector latch and slide the keyboard cable out of the keyboard connector on the system board.
 7. Remove the keyboard.

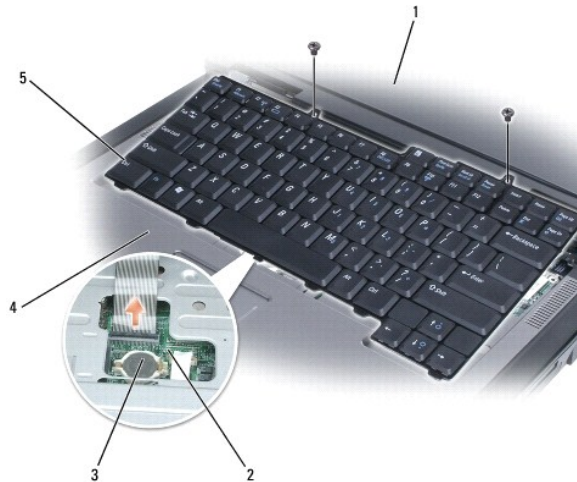

1	M2.5 x 5-mm screws (2)	2	keyboard cable	3	keyboard connector latch
4	tabs (5)	5	keyboard		

Replacing the Keyboard

1. Holding the keyboard slightly above the computer, slide the keyboard cable into the connector on the system board and close the connector latch.
2. Slide the tabs on the keyboard under the palm rest.

3. Press lightly on the top edges of the keyboard to snap it into place.
 4. Replace the two M2.5 x 5-mm screws at the top of the keyboard.
-

[Back to Contents Page](#)

Memory Module(s)

Dell™ Latitude™ 131L Service Manual

- [Removing the Memory Module\(s\)](#)
- [Replacing the Memory Module\(s\)](#)

⚠ CAUTION: Before you begin the following procedure, follow the safety instructions in the *Product Information Guide*.

👉 NOTICE: To prevent static damage to components inside your computer, discharge static electricity from your body before you touch any of your computer's electronic components. You can do so by touching an unpainted metal surface.

👉 NOTICE: To help prevent damage to the system board, you must remove the main battery (see [Before Working Inside Your Computer](#)) before you begin working inside the computer.

📌 NOTE: Memory modules purchased from Dell are covered under your computer warranty.

📌 NOTE: To get maximum performance/dual-channel memory bandwidth capability, both memory module connectors must contain memory modules and the modules must be of the same size and configuration.

Removing the Memory Module(s)

1. Follow the instructions in [Before You Begin](#).
2. Turn the computer upside-down.
3. Loosen the two captive screws on the memory module/modem cover and remove the cover.

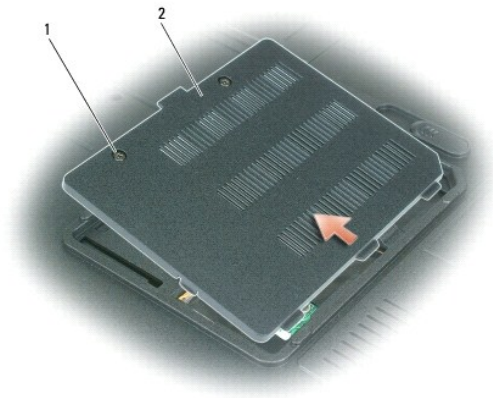

1	captive screws (2)	2	memory module/modem cover
---	--------------------	---	---------------------------

👉 NOTICE: To prevent damage to the memory module connector, do not use tools to spread the securing clips that secure the memory module.

👉 NOTICE: Handle memory modules by their edges, and do not touch the components on a module.

4. Use your fingertips to carefully spread apart the securing clips on each end of the memory module connector until the module pops up.
5. Remove the module from the connector at a 45-degree angle.

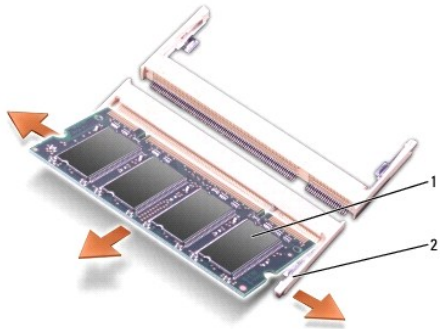

1	memory module	2	securing clips (2)
---	---------------	---	--------------------

Replacing the Memory Module(s)

- ➔ **NOTICE:** To prevent static damage to components inside your computer, discharge static electricity from your body before you touch any of your computer's electronic components. You can do so by touching an unpainted metal surface.
- 🔍 **NOTE:** To get maximum performance/dual-channel memory bandwidth capability, both memory module connectors must contain memory modules and the modules must be of the same size and configuration.
- 🔍 **NOTE:** If a memory module is not installed properly, the computer does not boot.

1. Align the notch in the module edge connector with the tab in the connector slot.
2. Slide the module firmly into the slot at a 45-degree angle, and lower the module until it clicks into place. If you do not feel the click, remove the module and reinstall it.

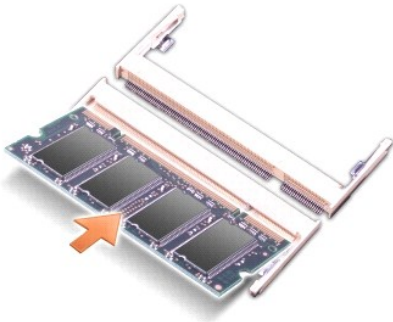

3. Replace the memory module/modem cover and tighten the captive screws.

- ➔ **NOTICE:** If the memory module/modem cover is difficult to close, remove the module and reinstall it. Forcing the cover to close may damage your computer.
4. Insert the battery into the battery bay, or connect the AC adapter to your computer and an electrical outlet.
 5. Turn on the computer.
- As the computer boots, it detects the additional memory and automatically updates the system configuration information.

Modem

Dell™ Latitude™ 131L Service Manual

- [Removing the Modem](#)
- [Replacing the Modem](#)

⚠ CAUTION: Before you begin the following procedure, follow the safety instructions in the *Product Information Guide*.

👉 NOTICE: To avoid electrostatic discharge, ground yourself by using a wrist grounding strap or by periodically touching an unpainted metal surface (such as the back panel) on the computer.

👉 NOTICE: To help prevent damage to the system board, you must remove the main battery (see [Before Working Inside Your Computer](#)) before you begin working inside the computer.

Removing the Modem

1. Follow the instructions in [Before You Begin](#).
2. Turn the computer upside-down, loosen the two captive screws on the memory module/modem cover, and remove the cover from the computer.

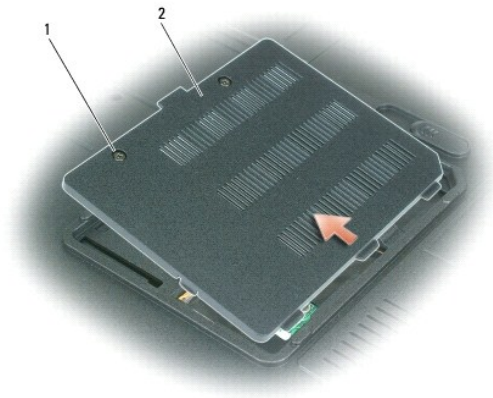

1	captive screws (2)	2	memory module/modem cover
---	--------------------	---	---------------------------

3. Remove the M2 x 3-mm screw that attaches the modem to the system board.
4. Pull up on the pull-tab to disconnect the modem from the modem connector on the system board.

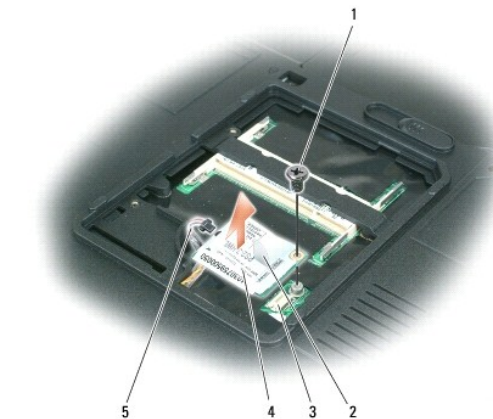

1	modem screw	2	modem pull-tab	3	modem connector on system board
4	modem	5	modem cable		

 **NOTICE:** Do not disconnect the modem cable from the system board.

5. Disconnect the modem cable from the modem.
-

Replacing the Modem

1. Connect the modem cable to the modem.

 **NOTICE:** Ensure that the modem cable is routed correctly when you replace the modem.

2. Align the connector on the bottom of the modem with the modem connector on the system board, and press down on the right side of the modem.
 3. Replace the M2 x 3-mm screw.
-

[Back to Contents Page](#)

[Back to Contents Page](#)

Optical Drive

Dell™ Latitude™ 131L Service Manual

- [Removing an Optical Drive](#)
- [Replacing an Optical Drive](#)

Your computer ships with a fixed optical drive installed.

⚠ CAUTION: Before you begin any of the procedures in this section, follow the safety instructions in the **Product Information Guide**.

🔒 NOTICE: To help prevent damage to drives, store them in a safe, dry place when they are not installed in the computer. Avoid pressing down on them or placing heavy objects on top of them.

Removing an Optical Drive

1. Follow the instructions in [Before You Begin](#).
2. On the bottom of the computer, remove the M2.5 x 8-mm device security screw labeled with a lock icon (🔒).
3. Insert a screwdriver into the indentation for the device security screw, and push the notch on the metal tab toward the media bay to release the optical drive from the media bay.

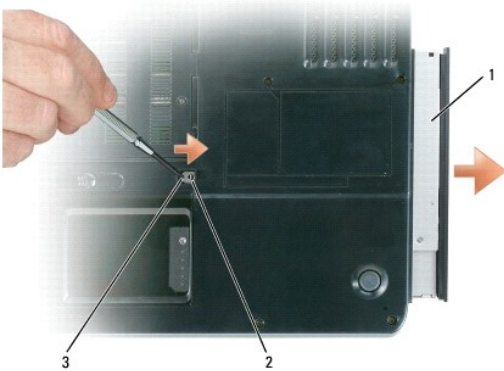

1	optical drive in media bay	2	indentation for M2.5 x 8-mm device security screw	3	notch
---	----------------------------	---	---	---	-------

4. Pull the drive out of the media bay.
-

Replacing an Optical Drive

1. Slide the optical drive into the media bay.
 2. Replace the device security screw next to the lock icon (🔒).
-

[Back to Contents Page](#)

Palm Rest

Dell™ Latitude™ 131L Service Manual

- [Removing the Palm Rest](#)
- [Replacing the Palm Rest](#)

⚠ CAUTION: Before you begin the following procedure, follow the safety instructions in the *Product Information Guide*.

👉 NOTICE: To avoid electrostatic discharge, ground yourself by using a wrist grounding strap or by periodically touching an unpainted metal surface (such as the back panel) on the computer.

👉 NOTICE: To help prevent damage to the system board, remove the main battery (see [Before Working Inside Your Computer](#)) before working inside the computer.

Removing the Palm Rest

1. Follow the instructions in [Before You Begin](#).
2. Remove the optical drive (see [Removing an Optical Drive](#)).
3. Remove the hinge cover (see [Removing the Hinge Cover](#)).
4. Remove the keyboard (see [Removing the Keyboard](#)).
5. Remove the display assembly (see [Removing the Display Assembly](#)).
6. Remove the eleven remaining M2.5 x 8-mm screws from the bottom of the computer.



1	M2.5 x 8-mm screws (11)
---	-------------------------

7. Turn the computer top-side up and loosen the captive screw on the palm rest.
8. Disconnect the touch pad connector and the standby switch connector from the system board.

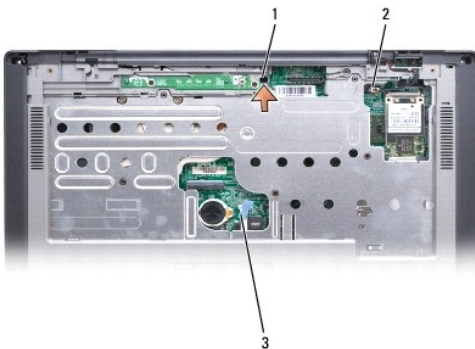

1	captive screw	2	standby switch connector	3	touch pad connector
---	---------------	---	--------------------------	---	---------------------

9. Lift the palm rest and remove it from the computer.



Replacing the Palm Rest

1. Align the palm rest with the computer base and gently snap it into place.
2. Reconnect the touch-pad connector and the standby switch connector to the system board.
3. Tighten the captive screw on the palm rest.
4. Turn the computer upside-down, and replace the eleven M2.5 x 8-mm screws on the bottom of the computer.
5. Replace the optical drive (see [Replacing an Optical Drive](#)).
6. Turn the computer top-side up and replace the display assembly (see [Replacing the Display Assembly](#)).
7. Replace the keyboard (see [Replacing the Keyboard](#)).
8. Replace the hinge cover (see [Replacing the Hinge Cover](#)).

[Back to Contents Page](#)

Pin Assignments for I/O Connectors

Dell™ Latitude™ 131L Service Manual

- [USB Connector](#)
- [Video Connector](#)

USB Connector

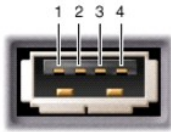

Pin	Signal
1	USB5V+
2	USBP-
3	USBP+
4	GND

Video Connector



Pin	Signal	Pin	Signal
1	CRT_R	9	5V+
2	CRT_G	10	GND
3	CRT_B	11	MONITOR_DETECT-
4	NC	12	DDC_DATA
5	GND	13	CRT_HS
6	GND	14	CRT_VS
7	GND	15	DDC_CLK
8	GND		

Speakers

Dell™ Latitude™ 131L Service Manual

- [Removing the Speakers](#)
- [Replacing the Speakers](#)

⚠ CAUTION: Before you begin the following procedure, follow the safety instructions in the *Product Information Guide*.

➡ NOTICE: To avoid electrostatic discharge, ground yourself by using a wrist grounding strap or by periodically touching an unpainted metal surface (such as the back panel) on the computer.

➡ NOTICE: To help prevent damage to the system board, remove the main battery (see [Before Working Inside Your Computer](#)) before working inside the computer.

Removing the Speakers

1. Follow the instructions in [Before You Begin](#).
2. Remove the hinge cover (see [Removing the Hinge Cover](#)).
3. Remove the keyboard (see [Removing the Keyboard](#)).
4. Remove the display assembly (see [Removing the Display Assembly](#)).
5. Remove the palm rest (see [Removing the Palm Rest](#)).

➡ NOTICE: Handle the speakers with care to help prevent damage to them.

6. Disconnect the speaker cable connector from the system board.
7. Remove the M2.5 x 5-mm screws from the speakers.

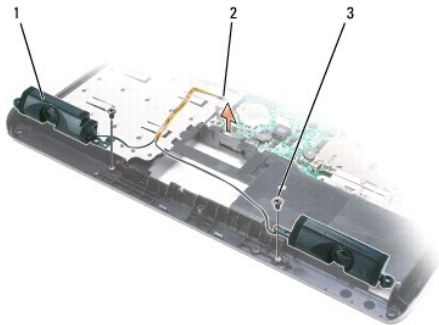

1	speakers (2)	2	speaker cable connector	3	M2.5 x 5-mm screws (2)
---	--------------	---	-------------------------	---	------------------------

8. Remove the speaker cable from the routing clips and remove the speakers.

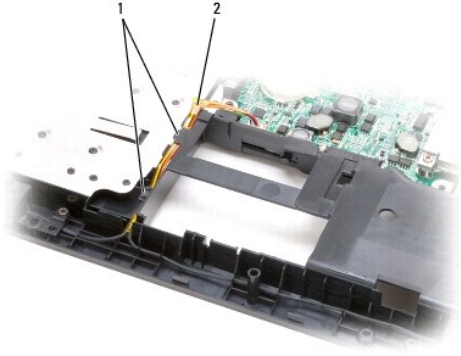

1	cable routing clips (2)	2	speaker cable
---	-------------------------	---	---------------

Replacing the Speakers

1. Route the speaker cable back through the routing clips and connect the speaker cable connector to the system board.
 2. Align the speakers on the screw holes for securing the speakers to the computer base.
 3. Replace the two M2.5 x 5-mm screws to secure the speakers in place (one on each speaker).
-

[Back to Contents Page](#)

System Board

Dell™ Latitude™ 131L Service Manual

- [Removing the System Board](#)
- [Replacing the System Board](#)

⚠ CAUTION: Before you begin the following procedure, follow the safety instructions in the *Product Information Guide*.

➡ NOTICE: To avoid electrostatic discharge, ground yourself by using a wrist grounding strap or by periodically touching an unpainted metal surface (such as the back panel) on the computer.

➡ NOTICE: To help prevent damage to the system board, remove the main battery (see [Before Working Inside Your Computer](#)) before working inside the computer.

The system board BIOS chip contains the Service Tag, which is also visible on a barcode label on the bottom of the computer. The replacement kit for the system board includes a CD that provides a utility for transferring the Service Tag to the replacement system board.

Removing the System Board

1. Follow the instructions in [Before You Begin](#).
2. Remove the hard drive (see [Removing the Hard Drive](#)).
3. Remove the optical drive (see [Removing an Optical Drive](#)).
4. Remove the memory module(s) (see [Removing the Memory Module\(s\)](#)).
5. Remove the modem (see [Removing the Modem](#)).
6. Remove the hinge cover (see [Removing the Hinge Cover](#)).
7. Remove the keyboard (see [Removing the Keyboard](#)).
8. Remove the Mini-Card (see [Removing a Mini-Card](#)).
9. Remove the display assembly (see [Removing the Display Assembly](#)).
10. Remove the palm rest (see [Removing the Palm Rest](#)).

🔧 NOTE: It is not required but is highly recommended that you remove the fan.

11. Remove the fan (see [Removing a Fan](#)).
12. Remove the processor thermal-cooling assembly (see [Removing the Processor Thermal-Cooling Assembly](#)).
13. Remove the processor (see [Removing the Processor Module](#)).
14. Remove the ExpressCard/hard-drive bay assembly (see [Removing the ExpressCard/Hard-Drive Bay Assembly](#)).
15. Remove the two hex-nut video screws from the back of the computer.

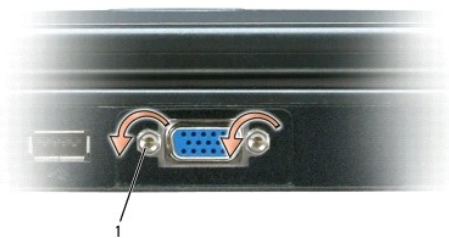

1	hex-nut video screws (2)
---	--------------------------

16. Remove the remaining two M2.5 x 5-mm screws from the system board.



1	M2.5 x 5-mm screws (2)
---	------------------------

17. Pull out slightly on the back right side of the computer to release the connectors on the system board from the base.
18. Lift the front of the system board and slowly ease the connectors out of the computer base and remove the system board.



Replacing the System Board

1. Carefully place the system board into the computer base.
2. Replace the two M2.5 x 5-mm screws in the system board.
3. Replace the two hex-nut video screws in the back of the computer.
4. Replace the ExpressCard/hard-drive bay assembly (see [Replacing the ExpressCard/Hard-Drive Bay Assembly](#)).
5. Replace the processor (see [Replacing the Processor Module](#)).
6. Replace the processor thermal-cooling assembly (see [Replacing the Processor Thermal-Cooling Assembly](#)).
7. Replace the fan (see [Replacing a Fan](#)).
8. Replace the palm rest (see [Replacing the Palm Rest](#)).
9. Replace the display assembly (see [Replacing the Display Assembly](#)).
10. Replace the Mini-Card (see [Replacing a Mini-Card](#)).
11. Replace the keyboard (see [Replacing the Keyboard](#)).
12. Replace the hinge cover (see [Replacing the Hinge Cover](#)).
13. Replace the modem (see [Replacing the Modem](#)).

14. Replace the memory module(s) (see [Replacing the Memory Module\(s\)](#)).

15. Replace the optical drive (see [Replacing an Optical Drive](#)).

16. Replace the hard drive (see [Replacing the Hard Drive](#)).

17. Replace the main battery (see [Before Working Inside Your Computer](#)).

 **NOTICE:** Before turning on the computer, replace all screws and ensure that no stray screws remain inside the computer. Failure to do so may result in damage to the computer.

18. Turn the computer over and turn it on.

 **NOTE:** If you use a BIOS update program CD to flash the BIOS, press <F12> before inserting the CD so that you can set up the computer to boot from a CD this one time only. Otherwise, you must enter the system setup program to change the default boot order.

19. Insert the flash BIOS update program CD that accompanied the replacement system board into the optical drive. Follow the instructions that appear on the screen. See "Flashing the Bios" for further information.

20. Enter the system setup program to update the BIOS on the new system board with the computer Service Tag.

[Back to Contents Page](#)

[Back to Contents Page](#)

Dell™ Latitude™ 131L Service Manual



NOTE: A NOTE indicates important information that helps you make better use of your computer.



NOTICE: A NOTICE indicates either potential damage to hardware or loss of data and tells you how to avoid the problem.



CAUTION: A CAUTION indicates a potential for property damage, personal injury, or death.

For a complete list of abbreviations and acronyms, see "Glossary" in the *User's Guide*.

If you purchased a Dell™ n Series computer, any references in this document to Microsoft® Windows® operating systems are not applicable.

Information in this document is subject to change without notice.
© 2006 Dell Inc. All rights reserved.

Reproduction in any manner whatsoever without the written permission of Dell Inc. is strictly forbidden.

Trademarks used in this text: *Dell*, the *DELL* logo, and *Inspiron* are trademarks of Dell Inc.; *Microsoft* and *Windows* are registered trademarks of Microsoft Corporation.

Other trademarks and trade names may be used in this document to refer to either the entities claiming the marks and names or their products. Dell Inc. disclaims any proprietary interest in trademarks and trade names other than its own.

Model PP23LB

October 2006 Rev. A00

[Back to Contents Page](#)