



Dell™ Inspiron™ 2600 and 2650

[A Tour of Your Computer](#)
[Solving Problems](#)
[Reinstalling Drivers and Utilities](#)
[Reinstalling Microsoft® Windows® Operating Systems](#)
[System Setup Program](#)
[Power Management](#)
[Using the Dell Diagnostics](#)
[Specifications](#)
[Pin Assignments for I/O Connectors](#)
[Removing and Replacing Parts](#)
[Documentation](#)

Hints, Notices, and Cautions

-  **HINT:** A HINT indicates important information that helps you make better use of your computer.
 -  **NOTICE:** A NOTICE indicates either potential damage to hardware or loss of data and tells you how to avoid the problem.
 -  **CAUTION:** A CAUTION indicates a potential for property damage, personal injury, or death.
-

Abbreviations and Acronyms

For a complete list of abbreviations and acronyms, see the *Tell Me How* help file. See "[Accessing Help](#)."

Information in this document is subject to change without notice.
© 2002–2003 Dell Computer Corporation. All rights reserved.

Reproduction in any manner whatsoever without the written permission of Dell Computer Corporation is strictly forbidden.

Trademarks used in this text: *Dell*, the *DELL* logo, *Inspiron*, *Dell Precision*, *Dimension*, *OptiPlex*, and *Latitude* are trademarks of Dell Computer Corporation; *Intel*, *Celeron*, *Pentium*, and *Intel SpeedStep* are registered trademarks of Intel Corporation; *Microsoft*, *MS-DOS*, and *Windows* are registered trademarks of Microsoft Corporation.

Other trademarks and trade names may be used in this document to refer to either the entities claiming the marks and names or their products. Dell Computer Corporation disclaims any proprietary interest in trademarks and trade names other than its own.

March 2003 Rev. A02

Base Plastics

Dell™ Inspiron™ 2600 and 2650

- [Removing the Base Plastics](#)
- [Replacing the Thermal Pad \(Inspiron 2650 Only\)](#)

Removing the Base Plastics

- ➔ **NOTICE:** Disconnect the computer and any attached devices from electrical outlets, and remove any installed batteries.
- ➔ **NOTICE:** To avoid ESD, ground yourself by using a wrist grounding strap or by touching an unpainted metal surface on the computer.
- ➔ **NOTICE:** Read "[Preparing to Work Inside the Computer](#)" before performing the following procedure.

1. Remove the [hard drive](#).
2. Remove the [optical drive](#).
3. Remove the [floppy drive](#).
4. Remove the [modem](#).
5. Remove the [keyboard](#).
6. Remove the [display assembly](#).
7. Remove the [EMI shield](#).
8. Remove the [video card](#).
9. Remove the [palm rest](#).
10. Remove the [microprocessor thermal-cooling assembly](#).
11. Remove the [speakers](#).
12. Remove the [system board](#).

- ➔ **NOTICE:** For Inspiron 2650 computers only, prior to replacing the base plastics, ensure that a thermal pad is present on the Memory Controller Hub (MCH) heat sink. If a thermal pad is already present, you do not need to replace it.

Replacing the Thermal Pad (Inspiron 2650 Only)

If the base assembly does not have a thermal pad installed, attach a new thermal pad inside the square etching on the MCH heat sink, located on the inside of the base plastics.

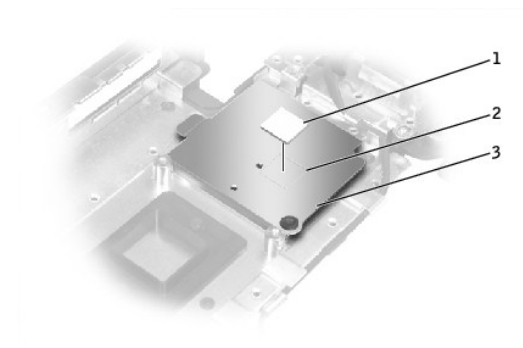

1	thermal pad
2	square etching on MCH heat sink
3	MCH

Battery Latch Assembly

Dell™ Inspiron™ 2600 and 2650

- [Removing the Battery Latch Assembly](#)
- [Replacing the Battery Latch Assembly](#)

Removing the Battery Latch Assembly

- ➔ **NOTICE:** Disconnect the computer and any attached devices from electrical outlets, and remove any installed battery.
- ➔ **NOTICE:** To avoid ESD, ground yourself by using a wrist grounding strap or by touching an unpainted metal surface on the computer.
- ➔ **NOTICE:** Read "[Preparing to Work Inside the Computer](#)" before performing the following procedure.

1. Remove the [hard drive](#).
2. Remove the [optical drive](#).
3. Remove the [floppy drive](#).
4. Remove the [keyboard](#).
5. Remove the [display assembly](#).
6. Remove the [EMI shield](#).
7. Remove the [video card](#).
8. Remove the [palm rest](#).
9. Remove the [microprocessor thermal-cooling assembly](#).
10. Remove the [speakers](#).
11. Remove the [system board](#).
12. Remove the M2 x 4-mm screw from the battery latch assembly.
13. Remove the latch spring and plate from the bottom case.

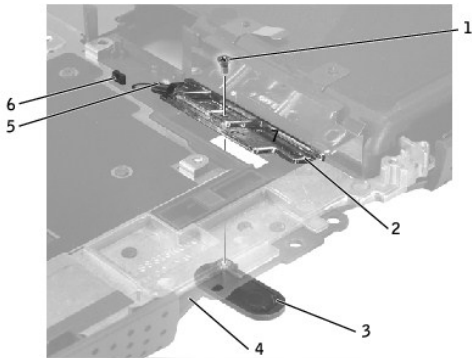

1	M2 x 4-mm screw (1)
2	latch plate
3	latch button
4	bottom case
5	latch spring
6	latch spring connector

Replacing the Battery Latch Assembly

1. Attach the latch spring to the latch spring connector in the bottom case.

2. Insert the latch plate in the bottom case.
 3. Install the new latch button from behind the bottom case, ensuring that the latch button and latch plate screw holes are properly aligned.
To prevent the latch assembly from coming loose, apply pressure to the latch plate and spring while replacing the latch button.
 4. Replace and tighten the M2 x 4-mm screw that secures the latch button to the bottom case.
Ensure that the newly installed latch moves smoothly and freely when pushed and released.
-

[Back to Contents Page](#)

Before You Remove or Replace Parts

Dell™ Inspiron™ 2600 and 2650

- [Preparing to Work Inside the Computer](#)
- [Recommended Tools](#)
- [Computer Orientation](#)
- [Screw Identification](#)

Preparing to Work Inside the Computer

CAUTION: Only a certified service technician should perform repairs on your computer. Damage due to servicing that is not authorized by Dell is not covered by your warranty. Read and follow applicable safety instructions in the *Owner's Manual* that came with the computer.

NOTICE: To avoid damaging the computer, perform the following steps before you begin working inside the computer.

1. Ensure that the work surface is flat and clean to prevent scratching the computer cover.
2. Save any work in progress and exit all open programs.

HINT: Ensure that the computer is off and not in a power management mode. If you cannot shut down the computer using the computer operating system, press and hold the power button for 4 seconds.

3. Turn off the computer and all attached devices.
4. Disconnect the computer from the electrical outlet.
5. To avoid possible damage to the system board, wait 10 to 20 seconds and then disconnect any attached devices.
6. Disconnect all other external cables from the computer.
7. Remove any installed PC Cards from the PC Card slot.
8. Close the display and turn the computer upside down on a flat work surface.

NOTICE: To avoid damaging the system board, you must remove the battery before you service the computer.

9. Remove the battery:
 - a. Unlock the battery.
 - b. Slide and hold the battery latch release all the way up until the left edge of the battery pops up.
 - c. Remove the battery.

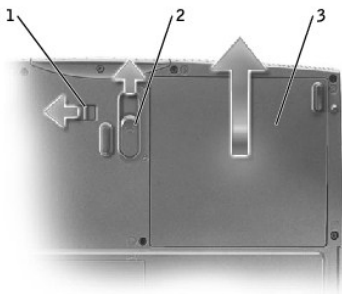

1	battery lock
2	battery latch release
3	battery

10. To dissipate any static electricity while you work, use a wrist grounding strap or periodically touch an unpainted metal surface.
 11. Handle components and cards with care. Do not touch the components or contacts on a card. Hold a card by its edges or by its metal mounting bracket. Hold a component such as a microprocessor by its edges, not by its pins.
-

Recommended Tools

The procedures in this document require the following tools:

- 1 #1 magnetized Phillips screwdriver
- 1 ¼-inch flat-blade screwdriver
- 1 Nut driver
- 1 Small plastic scribe
- 1 Microprocessor extractor
- 1 Flash BIOS update program floppy disk or CD

Computer Orientation



1	back
2	right
3	front
4	left





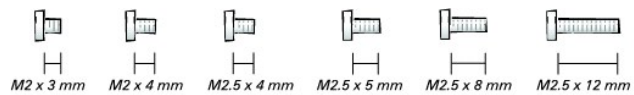









Screw Identification









When you are removing and replacing components, photocopy "[Screw Identification](#)" as a tool to lay out and keep track of the screws. The placemat provides the number of screws and their sizes.



NOTICE: When reinstalling a screw, you must use a screw of the correct diameter and length. Ensure that the screw is properly aligned with its corresponding hole, and avoid over tightening.

Hard Drive Door: (1 each)	Memory Module/ Modem Cover: (1 each)
------------------------------	--

 <p>M2.5 x 5 mm</p>	 <p>M2.5 x 5 mm</p>
<p>Modem to System Board: (2 each)</p>  <p>M2 x 3 mm</p>	<p>Optical Drive: (1 each)</p>  <p>M2.5 x 8 mm</p>
<p>Floppy Drive: (2 each)</p>  <p>M2.5 x 5 mm</p>	<p>Keyboard Assembly to Center Control Cover Hinges: (2 each)</p>  <p>M2.5 x 5 mm</p>
<p>Keyboard to Bottom Case: (4 each)</p>  <p>M2.5 x 4 mm</p>	<p>Display Assembly to Back Panel: (2 each)</p>  <p>M2.5 x 5 mm</p>
<p>Display-Feed Flex Cable to System Board: (2 each)</p>  <p>M2.5 x 5 mm</p>	<p>Hinge Bracket to Bottom Case: (4 each)</p>  <p>M2.5 x 5 mm</p>
<p>Display Bezel: (5 each)</p>  <p>M2.5 x 5 mm</p>	<p>Display Panel: (4 each)</p>  <p>M2 x 3 mm</p>
<p>Screw Covers (5 each)</p> <p>Display-Feed Flex Cable to Display Assembly: (1 each)</p>  <p>M2.5 x 5 mm</p>	<p>Display Latch: (2 each)</p>  <p>M2.5 x 5 mm</p>
<p>EMI Shield: (3 each)</p>	<p>Top of Palm Rest to Bottom Case: (2 each)</p>

 <p>M2.5 x 12 mm</p>	 <p>M2.5 x 5 mm</p>
<p>Video Card to Bottom Case: (1 each)</p> <p>Inspiron 2600 Inspiron 2650</p>   <p>M2.5 x 5 mm M2.5 x 8 mm</p>	<p>Palm Rest to Bottom Case: (12 each)</p>  <p>M2.5 x 8 mm</p>
<p>Floppy Drive Cage to Bottom Case: (2 each)</p>  <p>M2.5 x 5 mm</p>	<p>Hard Drive Cage to Bottom Case: (2 each)</p>  <p>M2.5 x 5 mm</p>
<p>System Board to Bottom Case: (6 each)</p>  <p>M2.5 x 4 mm</p>	<p>Battery Latch Assembly to Bottom Case: (1 each)</p>  <p>M2 x 4 mm</p>

Microprocessor Module

Dell™ Inspiron™ 2600 and 2650

- [Removing the Microprocessor Module](#)
- [Replacing the Microprocessor Module](#)
- [Flashing the BIOS](#)

Removing the Microprocessor Module

- ➔ **NOTICE:** Disconnect the computer and any attached devices from electrical outlets, and remove any installed battery.
- ➔ **NOTICE:** To avoid ESD, ground yourself by using a wrist grounding strap or by touching an unpainted metal surface on the computer.
- ➔ **NOTICE:** Read "[Preparing to Work Inside the Computer](#)" before performing the following procedure.
- ➔ **NOTICE:** Do not touch the processor die. Press and hold the microprocessor down on the substrate on which the die is mounted while turning the cam screw to prevent intermittent contact between the cam screw and microprocessor.
- ➔ **NOTICE:** To avoid damage to the microprocessor, hold the screwdriver so that it is perpendicular to the microprocessor when turning the cam screw.

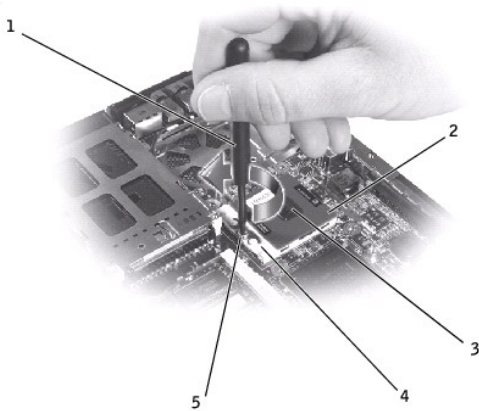

1	screwdriver (perpendicular to microprocessor)
2	pin-1 corner
3	processor die (do not touch)
4	ZIF socket
5	ZIF-socket cam screw

1. Remove the [keyboard](#).

➔ **NOTICE:** You must remove the display assembly before you remove the palm rest; the display hinges pass through the back of the palm rest.

2. Remove the [EMI shield](#).

➔ **NOTICE:** To ensure maximum cooling for the microprocessor, do not touch the heat transfer areas on the microprocessor thermal-cooling assembly. The oils in your skin reduce the heat transfer capability of the thermal pads.

3. Remove the [microprocessor thermal-cooling assembly](#).

➔ **NOTICE:** When removing the microprocessor module, pull the module straight up. Be careful not to bend the pins on the microprocessor module.

4. To loosen the ZIF socket, use a small, flat-blade screwdriver and rotate the ZIF-socket cam screw counterclockwise until it comes to the cam stop.

The ZIF-socket cam screw secures the microprocessor to the system board. Take note of the arrow on the ZIF-socket cam screw.

5. Use a microprocessor extraction tool to remove the microprocessor module.
-

Replacing the Microprocessor Module

➔ **NOTICE:** Ensure that the cam lock is in the fully open position before seating the microprocessor module. Seating the microprocessor module properly in the ZIF socket does not require force.

➔ **NOTICE:** A microprocessor module that is not properly seated can result in an intermittent connection, or permanent damage to the microprocessor and ZIF socket.

1. Align the pin-1 corner of the microprocessor module with the pin-1 corner of the ZIF socket, and insert the microprocessor module.

➔ **NOTICE:** You must position the microprocessor module correctly in the ZIF socket to avoid permanent damage to the module and the socket.

🔍 **HINT:** The pin-1 corner of the microprocessor module has a triangle that aligns with the triangle on the pin-1 corner of the ZIF socket.

When the microprocessor module is correctly seated, all four corners are aligned at the same height. If one or more corners of the module are higher than the others, the module is not seated correctly.



➔ **NOTICE:** Hold the microprocessor down while turning the cam screw to prevent intermittent contact between the cam screw and microprocessor.

2. Tighten the ZIF socket by turning the cam screw clockwise to secure the microprocessor module to the system board.
 3. [Update the BIOS](#) using a flash BIOS update program floppy disk or CD.
-

Flashing the BIOS

1. Ensure that the AC adapter is plugged in and that the battery is installed properly.
2. Turn on the computer.

Follow the instructions that appear on the screen. The computer continues to boot and updates the new BIOS. When the flash update is complete, the computer will automatically reboot.

3. Press  during POST to enter the system setup program.
 4. Press  to reset the computer defaults.
 5. Press  to save configuration changes and exit the system setup program.
 6. Remove the flash BIOS update floppy disk or CD from the drive and restart the computer.
-

[Back to Contents Page](#)

Using the Dell Diagnostics

Dell™ Inspiron™ 2600 and 2650

- [When to Use the Dell Diagnostics](#)
 - [Features of the Dell Diagnostics](#)
 - [Starting the Dell Diagnostics](#)
 - [Advanced Testing](#)
 - [Confirming the System Configuration Information](#)
-

When to Use the Dell Diagnostics

Whenever a major component or device in your computer does not function properly, you may have a component failure. If you are experiencing a problem with your computer, Dell recommends that you perform the checks in "[Solving Problems](#)" and run the Dell Diagnostics *before* you call Dell for technical assistance.

As long as the microprocessor and the display, keyboard, and optical drive are working, you can use the Dell Diagnostics. Running the Dell Diagnostics may help you to resolve the problem yourself quickly without having to contact Dell for assistance.

If you are experienced with computers and know what component(s) you need to test, simply select the appropriate diagnostic test group(s) or subtest(s). If you are unsure about how to begin diagnosing a problem, see "[Starting the Dell Diagnostics](#)" and "[Advanced Testing](#)."

Features of the Dell Diagnostics

The Dell Diagnostics helps you check your computer's hardware without any additional equipment and without destroying any data. By using the diagnostics, you can have confidence in your computer's operation. And if you find a problem you cannot solve by yourself, the diagnostic tests can provide you with important information you will need when talking to Dell's service and support personnel. If you are experiencing a problem with your computer, Dell recommends that you perform the checks in "[Solving Problems](#)" and run the Dell Diagnostics *before* you call Dell for technical assistance.

➡ **NOTICE:** Use the Dell Diagnostics to test only your Dell™ computer. Using this program with other computers may cause incorrect computer responses or result in error messages.

The diagnostic test groups or subtests also have these helpful features:



- 1 Options that let you perform quick checks or extensive tests on one or all devices
 - 1 An option that allows you to choose the number of times a test group or subtest is repeated
 - 1 The ability to display test results or to save them in a file
 - 1 Options to temporarily suspend testing if an error is detected, or to terminate testing when an adjustable error limit is reached
 - 1 Extensive online Help screens that describe the tests and how to run them
 - 1 Status messages that inform you whether test groups or subtests were completed successfully
 - 1 Error messages that appear if any problems are detected
-

Starting the Dell Diagnostics

📄 **HINT:** Dell recommends that you print these procedures before you begin.



Before you can start the Dell Diagnostics you need to reset your boot sequence and boot from the *Drivers and Utilities* CD for your computer.

📄 **HINT:** In the system setup program, a device preceded by an exclamation point (!) indicates that the device is disabled.

1. Turn off the computer.
2. Ensure that the computer is connected to an electrical outlet.
3. Turn on the computer with the *Drivers and Utilities* CD in the optical drive.
4. Press  to enter the system setup program as soon as the Dell logo screen appears, and before the Microsoft® Windows® logo screen appears.
5. Press the right-arrow key to select the **Boot** tab at the top of the screen.
6. Press the down-arrow key to select the **CD/DVD/CD-RW Drive**, and then press  to move the selected device to the top of the boot list.
7. Press  to save and exit the system setup program and restart the computer to boot from the CD.

The computer starts and automatically begins to run the Dell Diagnostics.

When you start the diagnostics, the Dell logo screen appears, followed by a message telling you that the diagnostics is loading. After the diagnostics loads, the **Diagnostics Menu** appears.

8. When you have completed running the diagnostics, remove the *Drivers and Utilities* CD.
9. When the computer restarts, press  as soon as the Dell logo screen appears, and before the Microsoft Windows logo screen appears.
10. Press the right-arrow key to select the **Boot** tab at the top of the screen.
11. Reset **Boot First Device** to **Hard Drive**.
12. Press  to save and exit the system setup program and restart Windows.
13. Remove the CD from the optical drive.
14. To select an option from this menu, highlight the option and press , or press the key that corresponds to the highlighted letter in the option you choose.

Diagnostics Menu



Option	Function
Test All Devices	Performs extensive diagnostic tests or quick diagnostic tests on all devices.
Test One Device	Performs extensive diagnostic tests or quick diagnostic tests on one device after you select it from a list of device groups. After you select Test One Device , press  for more information about a test.
Advanced Testing	Allows you to modify the parameters of a test and select a group of tests to perform. You can access online Help for more information about Advanced Testing .
Information and Results	Provides test results, test errors, version numbers of the subtests used by the Dell Diagnostics, and additional help on the Dell Diagnostics.
Program Options	Allows you to change the settings of the Dell Diagnostics.
Exit to MS-DOS	Exits to the MS-DOS® prompt.

For a quick check of your computer, select **Quick Tests** from the **Test All Devices** or **Test One Device** option. **Quick Tests** runs only the subtests that do not require user interaction and that do not take a long time to run. Dell recommends that you choose **Quick Tests** first to increase the odds of tracing the source of the problem quickly.

For a thorough check of your computer, select **Extended Tests** from the **Test All Devices** option.

To check a particular area of your computer, select **Extended Tests** from the **Test One Device** option, or select the **Advanced Testing** option to customize your test(s).

Advanced Testing

When you select **Advanced Testing** from the **Diagnostics Menu**, the **Advanced Testing** screen appears, listing the diagnostic test device groups and devices of the selected device group, and the screen allows you to select categories from a menu. Press the arrow keys or   to navigate the screen.

 **HINT:** The test groups reflect the configuration of your computer.



Advanced Testing Main Screen

Information in the **Advanced Testing** screen is presented as follows:

1. On the left side of the screen, the **Device Groups** area lists the diagnostic test groups in the order they will run if you select **All** from the **Run tests** menu category. Press the up- or down-arrow key to highlight a test device group.
1. On the right side of the screen, the **Devices for Highlighted Group** area lists the computer's currently detected hardware and some of the relevant settings.
1. Two lines at the bottom of the screen make up the menu area (see "[Advanced Testing Help Menu](#)"). The first line lists the categories you can select; press the left- or right-arrow key to highlight a menu category. The second line gives information about the category currently highlighted.

Advanced Testing Help Menu

For more information on using the **Advanced Testing** option:

1. Press .
2. Highlight the **Help** category and press , or press the key that corresponds to the highlighted letter in the category you choose.

Advanced Testing Help Categories

Help Category	Description
Menu	Provides descriptions of the main menu screen area, the device groups, the different diagnostic menus and commands, and instructions on how

	to use them.
Keys	Explains the functions of the all of the keystrokes that can be used in the Dell Diagnostics.
Device Group	Describes the test group that is presently highlighted in the Device Groups area on the main menu screen. It also provides reasoning for using some tests.
Device	Describes the function and purpose of the highlighted device in the Device Groups area . For example, the following information appears when you select the Device Help category for Diskette in the Device Groups list: Diskette Drive A The diskette disk drive device reads and writes data to and from diskettes. Diskettes are flexible recording media, sometimes contained in hard shells. Diskette recording capacities are small and access times are slow relative to hard disk drives, but they provide a convenient means of storing and transferring data.
Test	Provides a thorough explanation of the test procedure of each highlighted test group subtest. An example of the Diskette subtest floppy drive Seek Test is as follows: Diskette Drive A - floppy drive Seek Test This test verifies the drive's ability to position its read/write heads. The test operates in two passes: first, seeking from the beginning to ending cylinders inclusively, and second, seeking alternately from the beginning to ending cylinders with convergence towards the middle.
Versions	Lists the version numbers of the subtests that are used by the Dell Diagnostics.

Confirming the System Configuration Information

When you boot your computer from your *Drivers and Utilities* CD, the diagnostics checks your system configuration information and displays it in the **Device Groups** area on the main screen.

The following sources supply this configuration information for the diagnostics:

- 1 The system configuration information settings (stored in NVRAM) that you selected while using the system setup program
- 1 Identification tests of the microprocessor, the video controller, the keyboard controller, and other key components
- 1 BIOS configuration information temporarily saved in RAM

Do not be concerned if the **Device Groups** area does not list the names of all the components or devices you know are part of your computer. For example, you may not see a printer listed, although you know one is attached to your computer. Instead, the printer is listed as a parallel port. The computer recognizes the parallel port as LPT1, which is an address that tells the computer where to send outgoing information and where to look for incoming information. Because your printer is a parallel communications device, the computer recognizes the printer by its LPT1 address and identifies it as a parallel port. You can test your printer connection in the **Parallel Ports** tests.

[Back to Contents Page](#)

Display Assembly and Display Latch

Dell™ Inspiron™ 2600 and 2650

- [Display Assembly](#)
- [Display Latch](#)

Display Assembly

- ➔ **NOTICE:** You must remove the display assembly before you remove the palm rest.
- ➔ **NOTICE:** Disconnect the computer and any attached devices from electrical outlets, and remove any installed battery.
- ➔ **NOTICE:** To avoid ESD, ground yourself by using a wrist grounding strap or by touching an unpainted metal surface on the computer.
- ➔ **NOTICE:** Read "[Preparing to Work Inside the Computer](#)" before performing the following procedure.

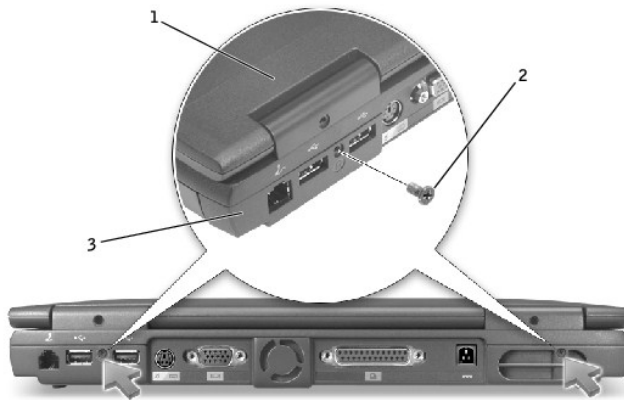

1	top cover
2	M2.5 x 5-mm screws (2)
3	bottom case

1. Remove the [keyboard](#).
2. Close the display assembly.
3. From the back of the computer, remove the two M2.5 x 5-mm screws labeled "circle D."
4. Open the display assembly approximately 180 degrees and support the display assembly so that it does not open past this position.
5. Remove the two M2.5 x 5-mm screws that secure the display-feed flex cable to the system board.

- ➔ **NOTICE:** When reconnecting the display-feed flex cable connector to the system board, push down on the top left and right ends of the connector. Pressing on the center of the connector may damage resistors and compromise EMI protection in the computer.

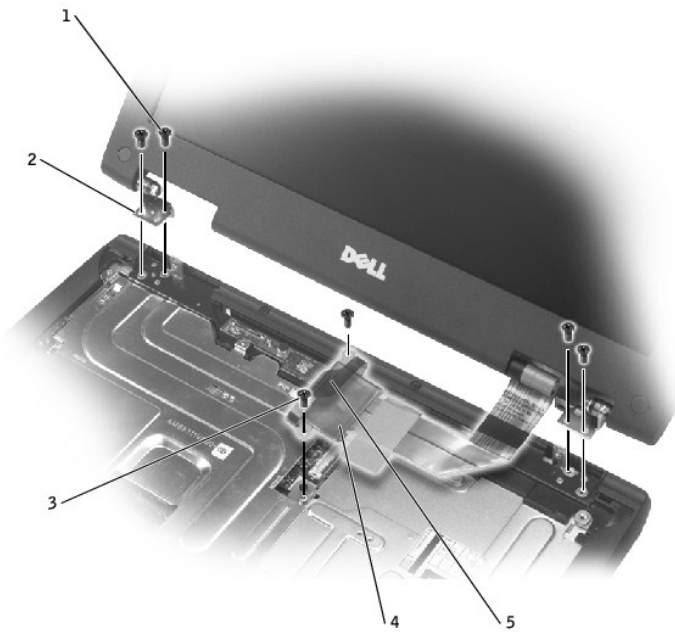

1	M2.5 x 5-mm screws (4)
2	hinge blocks (2)
3	M2.5 x 5-mm screws (2)
4	display-feed flex cable
5	pull tab

6. Pull up on the pull tab that is attached to the display-feed flex cable connector to remove the connector from the system board.
7. Remove the two M2.5 x 5-mm screws from each hinge block.
8. Lift the display assembly up and out of the bottom case.

14.1-Inch Display

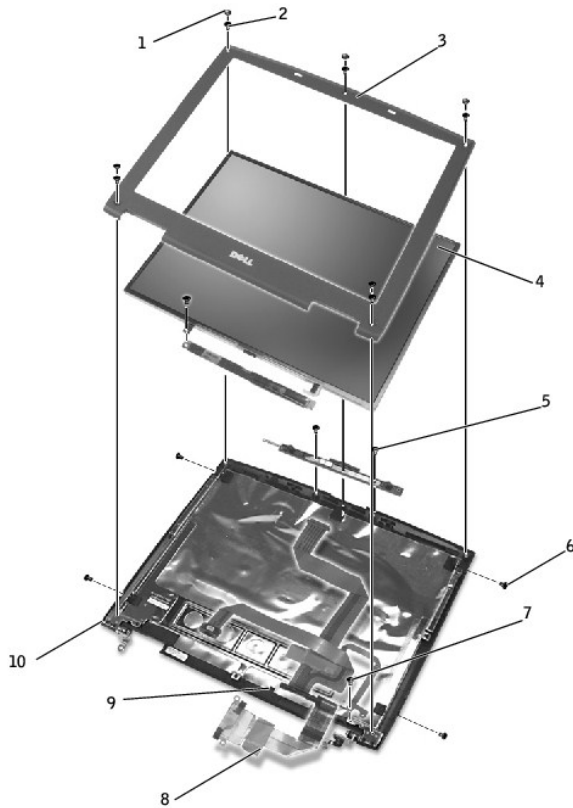

1	screw covers (5)	6	M2 x 3-mm screws (4)
2	M2.5 x 5-mm screws (5)	7	M2.5 x 5-mm screw (1)
3	display bezel	8	display-feed flex cable
4	display panel	9	flex-cable retention bracket
5	M2.5 x 5-mm screws (2)	10	top cover

Removing the Display Bezel

- ➔ **NOTICE:** Disconnect the computer and any attached devices from electrical outlets, and remove any installed battery.
 - ➔ **NOTICE:** To avoid ESD, ground yourself by using a wrist grounding strap or by touching an unpainted metal surface on the computer.
 - ➔ **NOTICE:** Read "[Preparing to Work Inside the Computer](#)" before performing the following procedure.
1. Remove the [keyboard](#).
 2. Remove the [display assembly](#).
 3. Use a plastic scribe to pry the five screw covers out of the screw holes located on the front of the bezel.
 4. Remove the five M2.5 x 5-mm screws located on the front of the bezel.
- ➔ **NOTICE:** Carefully separate the bezel from the top cover to avoid damage to the bezel.
5. Starting at the bottom of the display panel (by the Dell™ logo), use your fingers to separate the bezel from the top cover by lifting the inside of the bezel while pushing in on the outside.

Removing the 14-Inch Display Panel

- ➔ **NOTICE:** Disconnect the computer and any attached devices from electrical outlets, and remove any installed battery.
 - ➔ **NOTICE:** To avoid ESD, ground yourself by using a wrist grounding strap or by touching an unpainted metal surface on the computer.
 - ➔ **NOTICE:** Read "[Preparing to Work Inside the Computer](#)" before performing the following procedure.
1. Remove the [keyboard](#).

2. Remove the [display assembly](#).
3. Remove the [display bezel](#).
4. Remove the two M2 x 3-mm screws on the left side of the display panel.
5. Remove the two M2 x 3-mm screws on the right side of the display panel.
6. Remove the M2.5 x 5-mm screw that secures the display-feed flex cable to the display assembly.
7. Unsnap the flex-cable retention bracket from the top cover, and lift the bracket out of the display assembly.

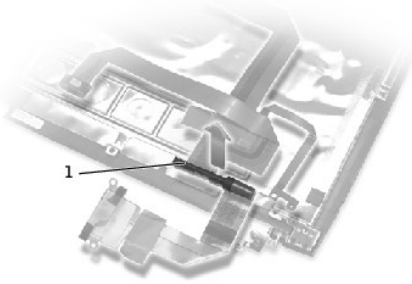

1 flex-cable retention bracket

8. Lift the display panel from the top, and rotate the display panel out of the top cover.
9. Disconnect the bottom flex-cable connector from the inverter connector on the system board by pulling on the attached pull tab away from the inverter connector.

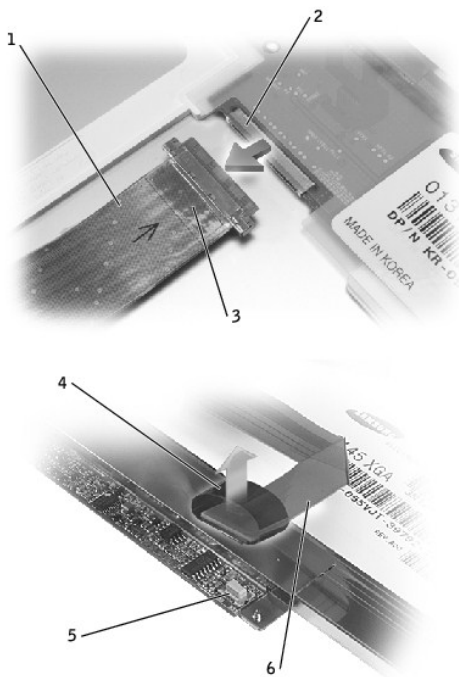

1 top flex-cable connector

2	display panel connector
3	pull tab
4	pull tab
5	inverter connector on system board
6	bottom flex-cable connector

- Remove the tape that secures the display panel connector and the tape that secures the middle of the display-feed flex cable to the display panel.
- Pull the top flex-cable connector down and away to remove it from the display panel connector.

Replacing the 14.1-Inch Display Panel

- Reconnect the top flex cable connector to the display panel connector.
- Reconnect the bottom flex cable connector to the inverter connector on the system board.
- Replace the tape that secures the display panel connector and the tape that secures the middle of the display-feed flex cable to the display panel.
- Place the bottom edge of the display panel in the bottom of the top cover, and elevate the top of the panel with your hand.
- Lay the display panel in the top cover.
- Reinstall the four M2 x 3-mm screws that secure the display panel to the top cover.
- Reinstall the M2.5 x 5-mm screw that secures the display-feed flex cable to the display assembly.

15-Inch Display

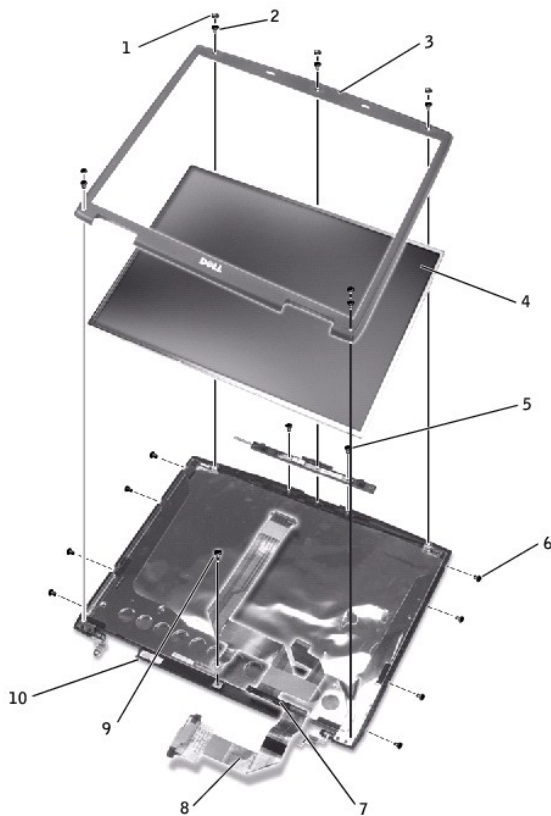

1	screw covers (5)	6	M2 x 3-mm screws (8)
2	M2.5 x 5-mm screws (5)	7	M2.5 x 5-mm screw (1)
3	display bezel	8	display-feed flex cable
4	display panel	9	flex-cable retention bracket
5	M2.5 x 5-mm screws (2)	10	top cover

Removing the 15-Inch Display Panel

- ➔ **NOTICE:** Disconnect the computer and any attached devices from electrical outlets, and remove any installed battery.
- ➔ **NOTICE:** To avoid ESD, ground yourself by using a wrist grounding strap or by touching an unpainted metal surface on the computer.
- ➔ **NOTICE:** Read "[Preparing to Work Inside the Computer](#)" before performing the following procedure.

1. Remove the [keyboard](#).
2. Remove the [display assembly](#).
3. Remove the [display bezel](#).
4. Remove the four M2 x 3-mm screws on the left side of the display panel.
5. Remove the four M2 x 3-mm screws on the right side of the display panel.
6. Remove the M2.5 x 5-mm screw that secures the display-feed flex cable to the display assembly.
7. Unsnap the flex-cable retention bracket from the top cover, and lift the bracket out of the display assembly.

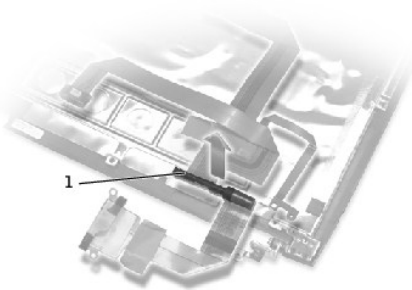

1	flex-cable retention bracket
---	------------------------------

8. Lift the display panel from the top, and rotate the display panel out of the top cover.
9. Disconnect the bottom flex-cable connector from the inverter connector on the system board by pulling on the attached pull tab away from the inverter connector.

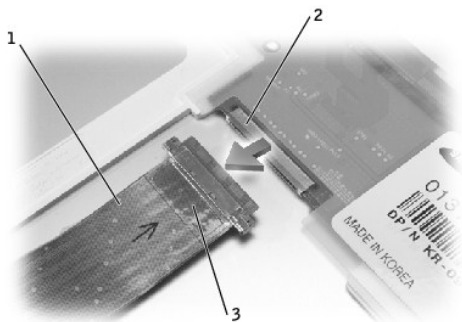

1	pull tabs
2	inverter connector on system board
3	bottom flex-cable connector

10. Pull the top flex-cable connector down and away to remove it from the display panel connector.

Replacing the 15-Inch Display Panel

1. Reconnect the top flex-cable connector to the display panel connector.
 2. Reconnect the bottom flex-cable connector to the inverter connector on the system board.
 3. Replace the tape that secures the display panel connector and the tape that secures the middle of the display-feed flex cable to the display panel.
 4. Place the bottom edge of the display panel in the bottom of the top cover and elevate the top of the panel with your hand.
 5. Lay the display panel in the top cover.
 6. Reinstall the eight M2 x 3-mm screws that secure the display panel to the top cover.
 7. Reinstall the M2.5 x 5-mm screw that secures the display-feed flex cable to the display assembly.
-

Display Latch

- ➔ **NOTICE:** Disconnect the computer and any attached devices from electrical outlets, and remove any installed battery.
- ➔ **NOTICE:** To avoid ESD, ground yourself by using a wrist grounding strap or by touching an unpainted metal surface on the computer.

Removing the Display Latch

1. Remove the [keyboard](#).
2. Remove the [display assembly](#).
3. Remove the [display bezel](#).
4. Remove the two M2.5 x 5-mm screws that secure the display latch and bracket to the top cover.
5. Lift the display latch, bracket, and spring up and out of the top cover.

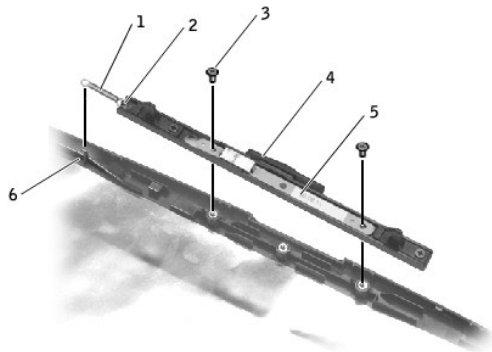

1	spring
2	spring hook (display latch)
3	M2.5 x 5-mm screws (2)
4	display latch
5	bracket
6	spring hook (top cover)

Replacing the Display Latch

1. Attach one end of the spring to the spring hook on the left edge of the display latch, and attach the other end of the spring to the spring hook in the top cover.
 2. Place the display latch on top of its screw holes, and then place the bracket on top of the display latch, aligning the bracket and display latch screw holes.
 3. Replace the two M2.5 x 5-mm screws that secure the display latch and bracket to the top cover.
-

[Back to Contents Page](#)

Reinstalling Drivers and Utilities

Dell™ Inspiron™ 2600 and 2650

- [Overview](#)
 - [Reinstalling Drivers and Utilities](#)
 - [Resolving Software and Hardware Incompatibilities](#)
 - [Using Microsoft® Windows System Restore](#)
-

Overview

Dell provides software utilities and drivers that help you control certain features of your computer. The utilities and drivers for Dell-installed devices are installed and operative when you receive the computer. If you ever need to reinstall any of these drivers, you can use the Dell™ *Drivers and Utilities* CD that came with your computer.

Often, device problems can be corrected by reinstalling the appropriate drivers. Also, hardware manufacturers frequently provide updated drivers that support feature enhancements or that correct problems. Obtain updated drivers for products purchased from Dell at the Dell Support website, support.dell.com.

- ➔ **NOTICE:** Drivers available on the Dell support website have been validated for correct operation on Dell computers. Installing drivers obtained from other sources may cause errors or performance degradation.

To install drivers and utilities, you need the following items:

- 1 Dell *Drivers and Utilities* CD
- 1 CD or DVD drive

Dell recommends that you print these procedures before you begin.

- ➔ **NOTICE:** Ensure that the computer is disconnected from any USB port replicator before you reinstall drivers.
-

Reinstalling Drivers and Utilities

Dell ships your computer to you with required drivers and utilities already installed—no further installation or configuration is needed.

- ➔ **NOTICE:** The *Drivers and Utilities* CD may contain drivers for operating systems that are not on your computer. Ensure that you are installing software appropriate for your operating system.

To reinstall drivers for optional devices such as wireless communications and DVD drives, you may need the CD and documentation that came with those devices.

- ➔ **NOTICE:** The Dell Support website, support.dell.com, and the *Drivers and Utilities* CD provide approved drivers for Dell computers. If you install drivers from other sources, your computer might not work correctly.

1. Save and close any open files, and exit any open programs.
2. Insert the *Drivers and Utilities* CD.

In most cases, the CD starts running automatically. If it does not, start Microsoft® Windows® Explorer, click your CD drive directory to display the CD contents, and then double-click the **autocd.exe** file. The first time that you run the CD, it might prompt you to install setup files. Click **OK**, and follow the instructions on the screen to continue.

3. From the **Language** pull-down menu in the toolbar, select your preferred language for the driver or utility (if available).

A welcome screen appears.

4. Click **Next**.

The CD automatically scans your hardware to detect drivers and utilities used by your computer.

After the CD completes the hardware scan, you can also detect other drivers and utilities. Under **Search Criteria**, select the appropriate categories from the **System Model**, **Operating System**, and **Topic** pull-down menus.

A link or links appear(s) for the specific drivers and utilities used by your computer.

5. Click the link of a specific driver or utility to display information about the driver or utility that you want to install.
6. Click the **Install** button (if present) to begin installing the driver or utility. At the welcome screen, follow the screen prompts to complete the installation.

If no **Install** button is present, automatic installation is not an option. For installation instructions, either see the appropriate instructions in the following subsections, or click the **Extract** button, follow the extracting instructions, and read the readme file.

If instructed to navigate to the driver files, click the CD directory on the driver information window to display the files associated with that driver.

Installing the Modem or Network Adapter Driver

If you ordered the internal modem, install the modem driver. If you ordered the network adapter, install the network adapter driver.

Windows XP

1. Save and close any open files, exit any open programs, and insert the *Drivers and Utilities* CD.
2. Click the **Start** button and click **Control Panel**.
3. Under **Pick a category**, click **Performance and Maintenance**.
4. Under **or pick a Control Panel icon**, click **System**.
5. Click the **Hardware** tab.
6. Click **Device Manager**. Click **Action** and click **Update Driver**.
7. Click **Install from a list or specific location (Advanced)** and click **Next**.
8. Verify that **Search removable media** is selected, and then click **Next**.
9. When the name of the appropriate driver appears, click **Next**.
10. Click **Finish** and restart your computer.

Windows 2000

1. Save and close any open files, exit any open programs, and insert the *Drivers and Utilities* CD.
2. Click the **Start** button, point to **Settings**, and then click **Control Panel**.
3. Double-click the **System** icon.
4. Click the **Hardware** tab.
5. Click **Device Manager**.
6. Click **Action** and click **Properties**.
7. Click the **Driver** tab, click **Update driver**, and then click **Next**.
8. Verify that **Search for a suitable driver for my device (Recommended)** is selected, and then click **Next**.
9. Verify that **CD-ROM drives** is selected, and then click **Next**.
10. When the name of the appropriate driver appears, click **Next**.
11. Click **Finish** and restart your computer.

Using Windows XP Device Driver Rollback

If you install a new device driver that causes system instability, you can use Windows XP Device Driver Rollback to replace the new device driver with the previously installed version of the device driver. If you cannot reinstall your previous driver by using Device Driver Rollback, then use [System Restore](#) to return your operating system to its previous operating state before you installed the new device driver. To use Device Driver Rollback:

1. Click the **Start** button and right-click **My Computer**.
2. Click **Properties**.
3. Click the **Hardware** tab and click **Device Manager**.
4. In the **Device Manager** window, right-click the device for which the new driver was installed and then click **Properties**.
5. Click the **Drivers** tab.
6. Click **Roll Back Driver**.

Resolving Software and Hardware Incompatibilities

IRQ conflicts occur if a device either is not detected during the operating system setup or is detected but incorrectly configured. See the following subsection that corresponds to your operating system to check for IRQ conflicts on your computer.

Windows XP

1. Click the **Start** button and click **Control Panel**.
2. Click **Performance and Maintenance** and click **System**.
3. Click the **Hardware** tab and click **Device Manager**.
4. In the **Device Manager** list, check for conflicts with the other devices.

Conflicts are indicated by a yellow exclamation point (!) beside the conflicting device or a red X if the device has been disabled.

5. Double-click any conflicting device listed to bring up the **Properties** window so that you can determine what needs to be reconfigured or removed from the Device Manager.
6. Resolve these conflicts before checking specific devices.

7. Double-click the malfunctioning device type in the **Device Manager** list.
8. Double-click the icon for the specific device in the expanded list.

The **Properties** window appears.

If an IRQ conflict exists, the **Device status** area in the **Properties** window reports what other devices are sharing the device's IRQ.

9. Resolve any IRQ conflicts.

You can also use Windows XP Hardware Troubleshooter. To use the troubleshooter, click the **Start** button and click **Help and Support**. Type **hardware troubleshooter** in the **Search** field, and then click the arrow to start the search. Click **Hardware Troubleshooter** in the **Search Results** list. In the **Hardware Troubleshooter** list, click **I need to resolve a hardware conflict on my computer**, and then click **Next**.

Windows 2000

1. Click the **Start** button, point to **Settings**, and then click **Control Panel**.
2. Double-click the **System** icon.
3. Click the **Hardware** tab.
4. Click **Device Manager**.
5. Click **View** and click **Resources by connection**.
6. Double-click **Interrupt request (IRQ)** to view the IRQ assignments.

Conflicts are indicated by a yellow exclamation point (!) beside the conflicting device or a red X if the device has been disabled.

7. Double-click any conflicting device listed to bring up the **Properties** window so that you can determine what needs to be reconfigured or removed from the Device Manager. Resolve these conflicts before checking specific devices.
8. Double-click the malfunctioning device type in the **Device Manager** list.
9. Double-click the icon for the specific device in the expanded list.

The **Properties** window appears.

If an IRQ conflict exists, the **Device status** area in the **Properties** window reports what other devices are sharing the device's IRQ.

10. Resolve any IRQ conflicts.

You can also use Windows 2000 Hardware Troubleshooter. To use the troubleshooter, click the **Start** button and click **Help**. Click **Troubleshooting and Maintenance** on the **Contents** tab, click **Windows 2000 troubleshooters**, and then click **Hardware**. In the **Hardware Troubleshooter** list, click **I need to resolve a hardware conflict on my computer**, and then click **Next**.

Using Microsoft® Windows System Restore

The Windows XP operating system provides a System Restore feature that allows you to return your computer to an earlier operating state if changes to the computer's hardware or software (including new hardware or program installations), or other system settings, have left the computer in an undesirable operating state. You can also undo the last *system restore*.

System Restore automatically creates system checkpoints. You can also manually create your own checkpoints by creating *restore points*. To limit the amount of hard disk space used, older restore points will be automatically purged.

To resolve an operating system problem, you can use System Restore from Safe Mode or Normal Mode to return your computer to an earlier operating state.

System Restore does not cause you to lose personal files stored in the **My Documents** folder, data files, or e-mail messages after restoring the computer to an earlier time. If you restore the computer to an operating state that existed before you installed a program, the program's data files are not lost, but you must reinstall the actual program again.

-  **NOTICE:** It is important to make regular backups of your data files. System Restore does not monitor changes to or recover your data files. If the original data on the hard disk is accidentally erased or overwritten, or if it becomes inaccessible because of a hard disk malfunction, use your backup files to recover the lost or damaged data.

System Restore is enabled on your new computer. However, if you reinstall Windows XP with less than 200 MB of free hard-disk space available, System Restore is automatically disabled. Before you use System Restore, confirm that it is enabled:

1. Click the **Start** button and click **Control Panel**.
2. Click **Performance and Maintenance**.
3. Click **System**.
4. Click the **System Restore** tab.
5. Ensure that **Turn off System Restore** is not checked.

Creating a Restore Point

In Windows XP, you can either use the System Restore Wizard or manually create restore points.

Using the System Restore Wizard

Click the **Start** button, click **Help and Support**, click **System Restore**, and then follow the instructions on the **System Restore Wizard** window. You can also create and name a restore point if you are logged on as the computer administrator or a user with administrator rights.

Manually Creating the Restore Points

1. Click the **Start** button, point to **All Programs**→**Accessories**→**System**→**Tools**, and then click **System Restore**.
2. Click **Create a restore point**.
3. Click **Next**.
4. Type a name for the new restore point in the **Restore point description** field.

The present date and time are automatically added to the description of the new restore point.

5. Click **Create**.
6. Click **OK**.

Restoring the Computer to an Earlier Operating State

If problems occur after installing a device driver, first try using [Device Driver Rollback](#). If Device Driver Rollback does not resolve the problem, then use [System Restore](#).

 **NOTICE:** Before restoring the computer to an earlier operating state, save and close all open files and exit all open programs. Do not alter, open, or delete any files or programs until the system restoration is complete.

1. Click the **Start** button, point to **All Programs**→**Accessories**→**System Tools**, and then click **System Restore**.
2. Ensure that **Restore my computer to an earlier time** is selected and click **Next**.
3. Click a calendar date to which you want to restore your computer.

The **Select a Restore Point** screen provides a calendar that allows you to see and select restore points. All calendar dates with available restore points appear in bold.

4. Select a restore point and click **Next**.

If a calendar date has only one restore point, then that restore point is automatically selected. If two or more restore points are available, click the restore point that you want to use.

 **NOTICE:** Save and close all open files and exit all open programs. Do not alter, open, or delete any files or programs until the system restoration is complete.

5. Click **Next**.

The **Restoration Complete** screen appears after System Restore finishes collecting data, and then the computer automatically restarts.

6. After the computer restarts, click **OK**.

To change the restore point, you can either repeat the steps using a different restore point, or you can undo the restoration.

Undoing the Last System Restore

 **NOTICE:** Save and close all open files and exit all open programs. Do not alter, open, or delete any files or programs until the system restoration is complete.

1. Click the **Start** button, point to **All Programs**→**Accessories**→**System Tools**, and then click **System Restore**.
2. Select **Undo my last restoration** and click **Next**.

 **NOTICE:** Save and close all open files and exit all open programs. Do not alter, open, or delete any files or programs until the system restoration is complete.

3. Click **Next**.
4. The **System Restore** screen appears, and then the computer automatically restarts.
5. After the computer restarts, click **OK**.

Back-Panel Fan (Inspiron 2650 Only)

Dell™ Inspiron™ 2600 and 2650

- [Removing the Back-Panel Fan](#)
- [Replacing the Back-Panel Fan](#)

Removing the Back-Panel Fan

- ➔ **NOTICE:** To prevent data loss, turn off the computer before removing the back-panel fan. Do not remove the fan while the computer is on or in a power management mode.
- ➔ **NOTICE:** Read "[Preparing to Work Inside the Computer](#)" before performing the following procedure.
 1. Ensure that the work surface is flat and clean to prevent scratching the computer cover.
 2. Save and close any open files, exit any open programs, and shut down the computer.
- ➔ **NOTICE:** Disconnect the computer and any attached devices from electrical outlets, and remove any installed batteries.
- ➔ **NOTICE:** To avoid ESD, ground yourself by using a wrist grounding strap or by touching an unpainted metal surface on the computer.
 3. Turn the computer over. Use a #1 Phillips screwdriver to remove the two M2.5 x 5-mm screws from the fan cover, and place the screws in a safe location.

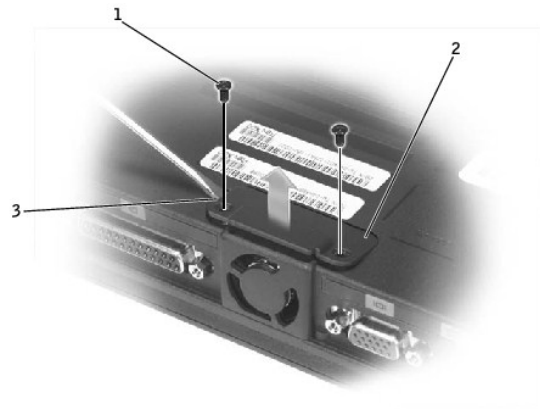

1	M2.5 x 5-mm screws (2)
2	fan cover
3	scalloped left edge of fan cover

4. Use a small flat-blade screwdriver or plastic scribe to lift the scalloped left edge of the fan cover, and pry the cover loose from the bottom case.
5. Lift the fan cover up and away from the bottom case.
6. Disconnect the fan cable connector from the system board.
7. Lift the fan out of the bottom case.

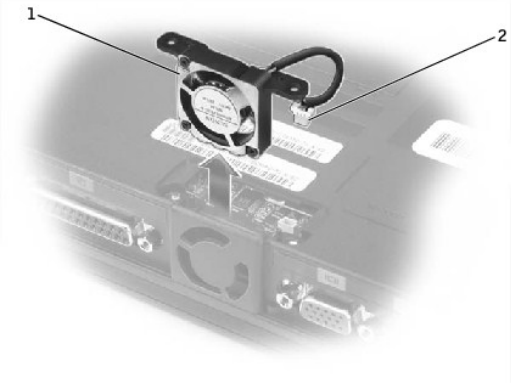

1	fan
2	fan cable connector

Replacing the Back-Panel Fan

1. Slide the fan into the bottom case.
2. Tuck the fan cable under the bottom case, and connect the cable to the system board.



1	fan cable
---	-----------

3. Replace the fan cover, and reinstall the two M2.5 x 5-mm screws that secure the cover to the bottom case.

Hard Drive

Dell™ Inspiron™ 2600 and 2650

- [Removing the Hard Drive](#)
- [Replacing the Hard Drive](#)

Removing the Hard Drive

- ⚠ **CAUTION:** If you remove the hard drive from the computer when the drive is hot, *do not touch* the metal housing of the hard drive.
 - ➡ **NOTICE:** To prevent data loss, turn off the computer before removing the hard drive. Do not remove the hard drive while the computer is on or in a power management mode.
 - ➡ **NOTICE:** Hard drives are extremely fragile; even a slight bump can damage the drive.
 - ➡ **NOTICE:** Read "[Preparing to Work Inside the Computer](#)" before performing the following procedure.
1. Ensure that the work surface is flat and clean to prevent scratching the computer cover.
 2. Save and close any open files, exit any open programs, and shut down the computer.
- ➡ **NOTICE:** Disconnect the computer and any attached devices from electrical outlets, and remove any installed battery.
 - ➡ **NOTICE:** To avoid ESD, ground yourself by using a wrist grounding strap or by touching an unpainted metal surface on the computer.
3. Turn the computer over. Use a #1 Phillips screwdriver to remove the M2.5 x 5-mm screw from the hard drive door, and place the screw in a safe location.
- ➡ **NOTICE:** When the hard drive is not in the computer, store it in protective antistatic packaging.

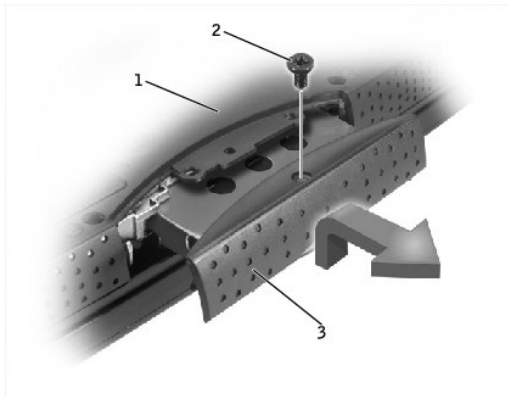

1	bottom of computer
2	M2.5 x 5-mm screw
3	hard drive door

4. Lift the hard drive door to release it, and slide the hard drive out of the computer.

Replacing the Hard Drive

1. Remove the new drive from its packaging.
Save the original packaging to use when storing or shipping the hard drive.
- ➡ **NOTICE:** Use firm and even pressure to slide the drive into place. If you force the hard drive into place using excessive force, you may damage the connector.
2. Slide the hard drive into the bay until it is fully seated.
 3. Replace and tighten the M2.5 x 5-mm screw in the hard drive door.

4. Use the *Operating System* CD to install the operating system for your computer.
5. Use the *Drivers and Utilities* CD to install the drivers and utilities for your computer.

[Back to Contents Page](#)

Keyboard

Dell™ Inspiron™ 2600 and 2650

- [Removing the Keyboard](#)
- [Replacing the Keyboard](#)

Removing the Keyboard

- ➔ **NOTICE:** Disconnect the computer and any attached devices from electrical outlets, and remove any installed battery.
- ➔ **NOTICE:** To avoid ESD, ground yourself by using a wrist grounding strap or by touching an unpainted metal surface on the computer.
- ➔ **NOTICE:** Read "[Preparing to Work Inside the Computer](#)" before performing the following procedure.

1. Remove the center control cover:
 - a. Remove the two M2.5 x 5-mm screws in the back of the hinges.



1 M2.5 x 5-mm screws (2)

- b. Open the display assembly at an angle of approximately 180 degrees and support the display assembly so that it does not open past this position.
- c. Use a small flat-blade screwdriver or plastic scribe to lift the scalloped right edge of the center control cover and pry the cover loose from the hinges and bottom case.
- d. Lift the center control cover up and away from the hinges and bottom case.

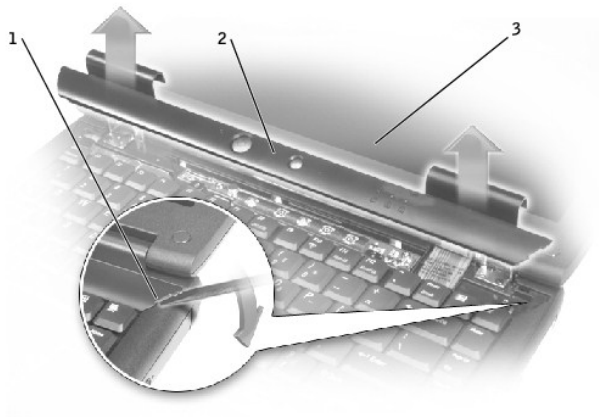

1	scalloped edge of center control cover
2	center control cover
3	display assembly

 **HINT:** The M2.5 x 4-mm screws are silver.

- Remove the four M2.5 x 4-mm screws at the top of the keyboard.

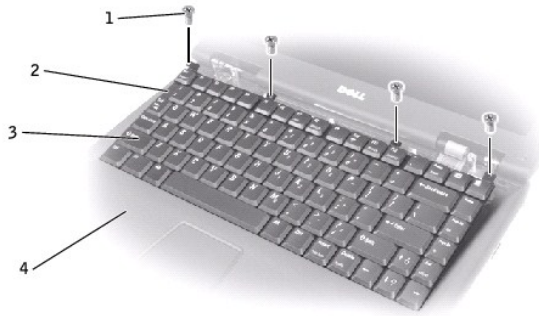

1	M2.5 x 4-mm screws (4)
2	scalloped edge of blank key
3	keyboard
4	palm rest

 **NOTICE:** The keycaps on the keyboard are fragile, easily dislodged, and time-consuming to replace. Be careful when removing and handling the keyboard.

- Lift the keyboard straight up until it clears the top of the bottom case.
- Rotate the keyboard forward toward the front of the computer.
- Rest the key face of the keyboard on the palm rest.

 **NOTICE:** Do not pull on the keyboard flex cable.

- Pull up on the keyboard connector to disconnect it from the interface connector on the system board.

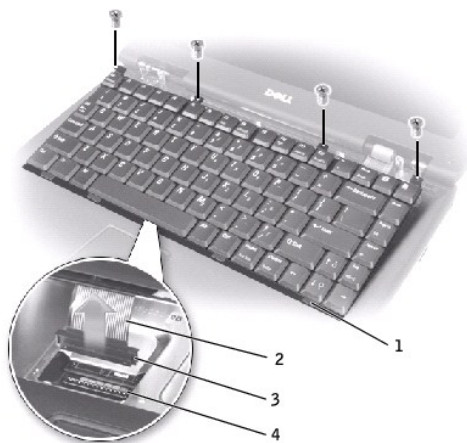

1	keyboard securing tabs (4)
2	keyboard flex cable
3	keyboard connector
4	interface connector on system board

7. Remove the keyboard from the bottom case.
-

Replacing the Keyboard

 **NOTICE:** The keycaps on the keyboard are fragile, easily dislodged, and time-consuming to replace. Be careful when handling and replacing the keyboard.

1. Place the keyboard on the palm rest at the front of the computer with the keys face down and the connector toward the back of the computer.

 **NOTICE:** To avoid damage to the connector pins, press the keyboard connector evenly into the interface connector on the system board, and do not reverse the keyboard connector.

2. Connect the keyboard connector to the interface connector on the system board.

The keyboard connector may have a label on it that shows the correct orientation of the keyboard connector to the interface connector on the system board.

 **NOTICE:** Position the keyboard flex cable so that it is not pinched when you replace the keyboard in the bottom case.

3. Rotate the keyboard back and fit it into the bottom case.

Ensure that all four securing tabs are engaged in their respective slots before trying to completely seat the keyboard. Fitting the tabs to the slots may be easiest when viewed from above and slightly behind the front edge of the keyboard. Press down on the left and right  keys to help control tab/slot alignment.

When the keyboard appears to be completely seated, confirm that the front edge of the keyboard is aligned with the edge of the palm rest before proceeding.

4. Check that the keyboard is correctly installed. The keys should be flush with the left and right surfaces of the palm rest.

 **HINT:** The M2.5 x 4-mm screws are silver.

5. Replace the four M2.5 x 4-mm screws at the top of the keyboard.
6. Replace the center control cover.

Ensure that the center control cover is snapped in properly so that it is flush with the keyboard.

7. Replace the two M2.5 x 5-mm screws in the back of the hinges.
-

[Back to Contents Page](#)

EMI Shield, Video Card, and Palm Rest

Dell™ Inspiron™ 2600 and 2650

- [EMI Shield](#)
- [Video Card](#)
- [Palm Rest](#)

EMI Shield

- ➔ **NOTICE:** Disconnect the computer and any attached devices from electrical outlets, and remove any installed battery.
 - ➔ **NOTICE:** To avoid ESD, ground yourself by using a wrist grounding strap or by touching an unpainted metal surface on the computer.
 - ➔ **NOTICE:** Read "[Preparing to Work Inside the Computer](#)" before performing the following procedure.
1. Remove the [keyboard](#).
 2. Remove the two M2.5 x 5-mm screws that secure the display-feed flex cable to the system board.
- ➔ **NOTICE:** When reconnecting the display-feed flex cable connector to the system board, push down on the top left and right ends of the connector. Pressing on the center of the connector may damage resistors and compromise EMI protection in the computer.
3. Pull up on the pull tab that is attached to the display-feed flex cable connector to remove the connector from the system board.
 4. Remove the three M2.5 x 12-mm screws that secure the EMI shield to the bottom case, and pull the EMI shield out of the bottom case.

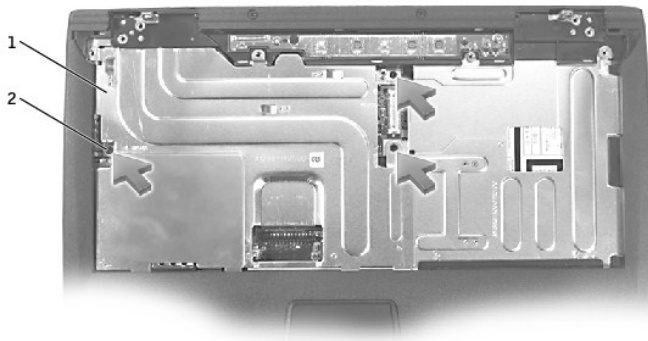

1	EMI shield
2	M2.5 x 12-mm screws (3)

Video Card

Removing the Inspiron 2600 Video Card

- ➔ **NOTICE:** Disconnect the computer and any attached devices from electrical outlets, and remove any installed battery.
 - ➔ **NOTICE:** To avoid ESD, ground yourself by using a wrist grounding strap or by touching an unpainted metal surface on the computer.
 - ➔ **NOTICE:** Read "[Preparing to Work Inside the Computer](#)" before performing the following procedure.
1. Remove the [keyboard](#).
 2. Remove the [EMI shield](#).
 3. Remove the M2.5 x 5-mm screw that secures the video card to the system board.
 4. Pull the video card by the edges toward the front of the computer to remove the video card from the bottom case.

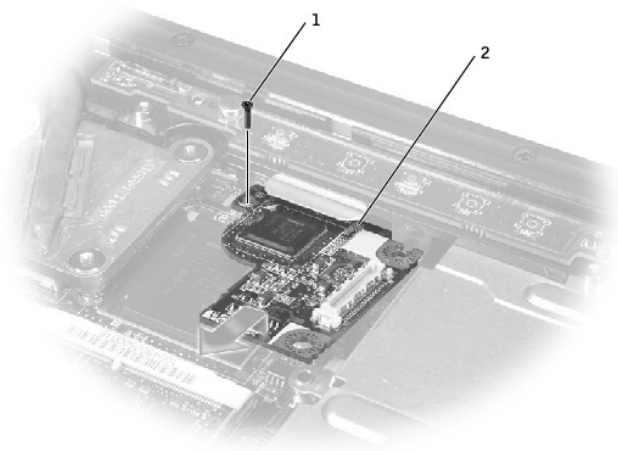

1	M2.5 x 5-mm screw (1)
2	video card

Replacing the Inspiron 2600 Video Card

1. Align the top-right corner of the video card with the guide on the system board, and slide the top edge of the video card under the palm rest.

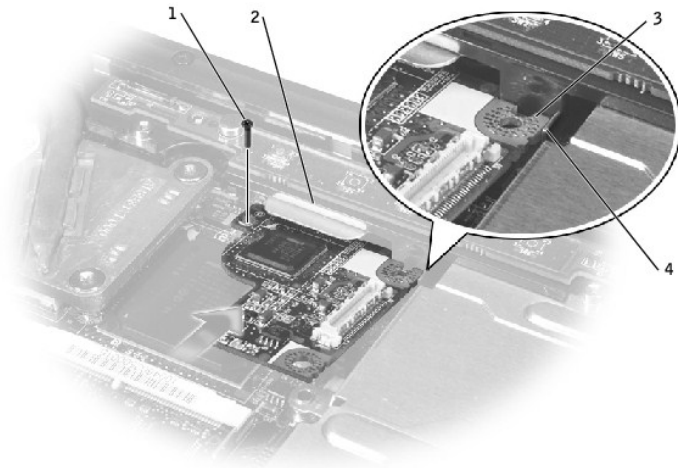

1	M2.5 x 5-mm screw (1)
2	palm rest
3	top-right corner of the video card
4	guide

2. Lay the video card flat on the system board, and connect the video card connector to the interface connector on the system board.

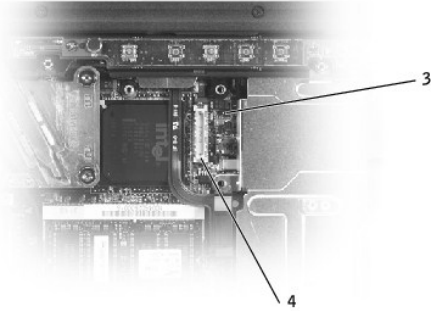
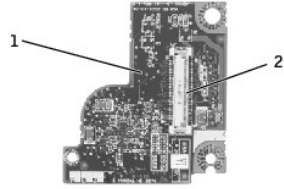

1	bottom of video card
2	video card connector
3	system board
4	interface connector

3. Reinstall the M2.5 x 5-mm screw that secures the video card to the bottom case.
4. Replace the [EMI shield](#).
5. Replace the [keyboard](#).

Removing the Inspiron 2650 Video Card

- ➔ **NOTICE:** Disconnect the computer and any attached devices from electrical outlets, and remove any installed battery.
- ➔ **NOTICE:** To avoid ESD, ground yourself by using a wrist grounding strap or by touching an unpainted metal surface on the computer.
- ➔ **NOTICE:** Read "[Preparing to Work Inside the Computer](#)" before performing the following procedure.

1. Remove the [keyboard](#).
2. Remove the [EMI shield](#).
3. Remove the M2.5 x 8-mm screw that secures the video card to the system board.
4. Pull the video card by the pull tab toward the front of the computer to remove the video card from the bottom case.

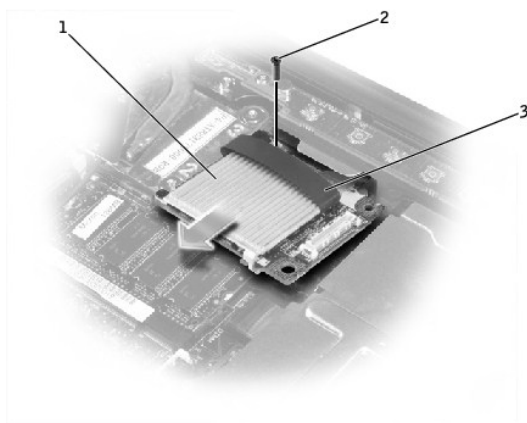

1	video card
2	M2.5 x 8-mm screw (1)
3	pull tab

Replacing the Inspiron 2650 Video Card

1. Align the top-right corner of the video card with the guide on the system board, and slide the top edge of the video card under the palm rest.

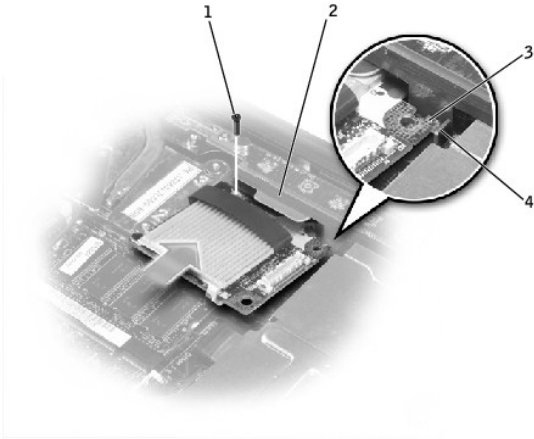

1	M2.5 x 8-mm screw (1)
2	palm rest
3	top-right corner of the video card
4	guide

2. Lay the video card flat on the system board, and connect the video card connector to the interface connector on the system board.

➔ **NOTICE:** Before you connect the video card to the system board, ensure that you route the power-board flex cable under the memory module.

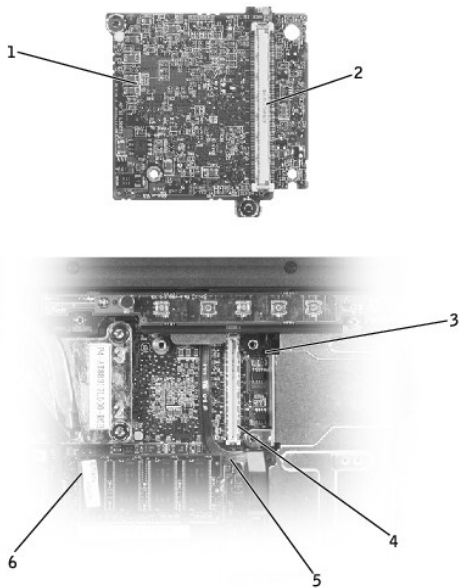

1	bottom of video card
2	video card connector
3	system board
4	interface connector
5	power-board flex cable
6	memory module

3. Reinstall the M2.5 x 8-mm screw that secures the video card to the bottom case.
4. Replace the [EMI shield](#).
5. Replace the [keyboard](#).

Palm Rest

- ➔ **NOTICE:** Disconnect the computer and any attached devices from electrical outlets, and remove any installed battery.
 - ➔ **NOTICE:** To avoid ESD, ground yourself by using a wrist grounding strap or by touching an unpainted metal surface on the computer.
 - ➔ **NOTICE:** Read "[Preparing to Work Inside the Computer](#)" before performing the following procedure.
1. Remove the [keyboard](#).
 - ➔ **NOTICE:** You must remove the display assembly before you remove the palm rest: the display hinges pass through the back of the palm rest.
 2. Remove the [display assembly](#).
 3. Remove the [EMI shield](#).
 4. Remove the [video card](#).
 5. Remove the two M2.5 x 5-mm screws from the top of the palm rest.

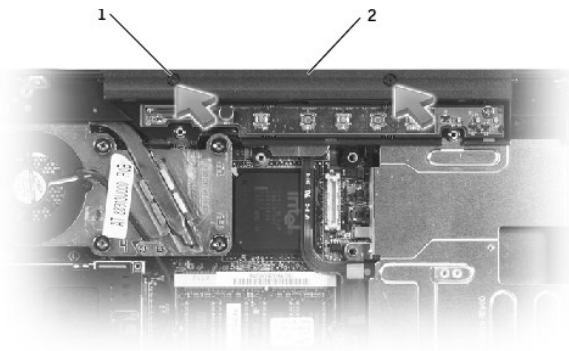

1	M2.5 x 5-mm screws (2)
2	top of the palm rest

6. Turn the computer over and remove the twelve M2.5 x 8-mm screws labeled "circle P."

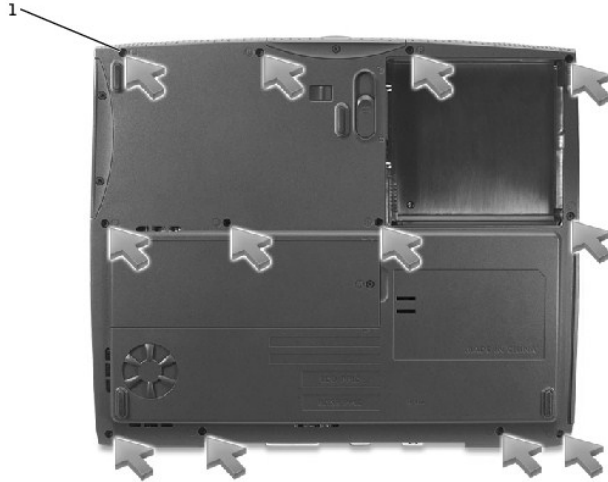

1	M2.5 x 8-mm screws (12)
---	-------------------------

7. Turn the computer over, and disconnect the touch pad connector and power board connector from the system board.

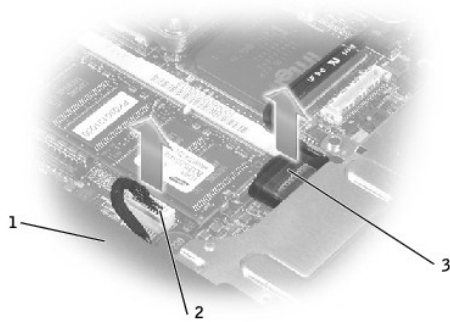

1	back center of the palm rest
2	touch pad connector
3	power board connector

NOTICE: Carefully separate the palm rest from the base plastics to avoid damage to the palm rest.

8. Starting at the back center of the palm rest, use your fingers to separate the palm rest from the base plastics by lifting the inside of the palm rest while pushing in on the outside.

[Back to Contents Page](#)

Pin Assignments for I/O Connectors

Dell™ Inspiron™ 2600 and 2650

- [USB Connector](#)
 - [PS/2 Connector](#)
 - [Video Connector](#)
 - [Parallel Connector](#)
-

USB Connector

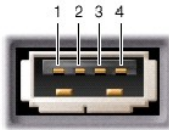

Pin	Signal
1	USB5V+
2	USBP-
3	USBP+
4	GND

PS/2 Connector

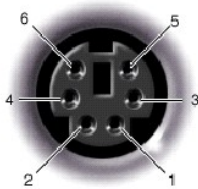

Pin	Signal
1	KBDATA
2	PS2DATA
3	GND
4	VCC
5	KBCLK
6	PS2CLK

Video Connector



Pin	Signal	Pin	Signal
1	CRT_R	9	5V+
2	CRT_G	10	GND
3	CRT_B	11	MONITOR_DETECT-
4	NC	12	DDC_DATA
5	GND	13	CRT_HS
6	GND	14	CRT_VS
7	GND	15	DDC_CLK
8	GND		

Parallel Connector

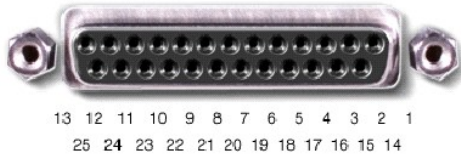

Pin	Signal	Pin	Signal
1	STROBE-	10	ACK-
2	PD0	11	BUSY
3	PD1	12	PE
4	PD2	13	SLCT
5	PD3	14	AFD/3M-
6	PD4	15	ERROR-
7	PD5	16	INIT-
8	PD6	17	SLIN-
9	PD7	18-25	GND

[Back to Contents Page](#)

Power Management

Dell™ Inspiron™ 2600 and 2650

- [Management Tips](#)
 - [Power Management Modes](#)
 - [Power Options Properties](#)
 - [Battery Performance](#)
-

Management Tips

- 1 Connect the computer to an electrical outlet when possible because the battery life expectancy is largely determined by the number of times it is charged.
 - 1 Place the computer in [standby mode](#) or [hibernate mode](#) when you leave the computer unattended for long periods of time.
 - 1 To exit a power management mode, press the power button.
-

Power Management Modes

Standby Mode

Standby mode conserves power by turning off the display and the hard drive after a predetermined period of inactivity (a time-out). When the computer exits standby mode, it returns to the same operating state it was in before entering standby mode.



 **NOTICE:** If your computer loses AC and battery power while in standby mode, it may lose data.

To enter standby mode:

- 1 In the Microsoft® Windows® XP operating system, click the **Start** button, click **Turn off computer**, and then click **Standby**.

In Windows® 2000, click the **Start** button, click **Shutdown**, click **Standby**, and then click **OK**.

or

- 1 Depending on how you set the power management options on the **Advanced** tab in the **Power Options Properties** window, use one of the following methods:
 - o Press the power button.
 - o Close the display.
 - o Press  .

To exit standby mode, press the power button or open the display depending on how you set the options on the **Advanced** tab. You cannot make the computer exit standby mode by pressing a key or touching the touch pad.

Hibernate Mode

Hibernate mode conserves power by copying system data to a reserved area on the hard drive and then completely turning off the computer. When the computer exits hibernate mode, it returns to the same operating state it was in before entering hibernate mode.

Your computer enters hibernate mode if the battery charge level becomes critically low.

Depending on how you set the power management options on the [Advanced tab](#) in the **Power Options Properties** window, use one of the following methods to enter hibernate mode:

- 1 Press the power button.
- 1 Close the display.

- 1 Press  .

 **HINT:** Some PC Cards may not operate correctly after the computer exits hibernate mode. Remove and reinsert the card, or simply restart (reboot) your computer.

To exit hibernate mode, press the power button. The computer may take a short time to exit hibernate mode. You cannot make the computer exit hibernate mode by pressing a key or touching the touch pad. For more information on hibernate mode, see the documentation that came with your operating system.

Power Options Properties

 **HINT:** Dell recommends that you use the **Portable/Laptop** power scheme to maximize battery power.

To access the Windows **Power Options Properties** window, see the following subsection that corresponds to your operating system.

In Windows XP

1. Click the **Start** button and click **Control Panel**.
2. Under **Pick a category**, click **Performance and Maintenance**.
3. Under **or pick a Control Panel icon**, click **Power Options**.

In Windows 2000

1. Open the Control Panel.
2. Double-click the **Power Options** icon.

Power Schemes Tab

The **Power schemes** pull-down menu displays the selected preset power scheme. Depending on your operating system, typical power schemes are:

- 1 **Portable/Laptop**
- 1 **Home/Office**
- 1 **Always On**
- 1 **Presentation**
- 1 **Minimal Power Management**
- 1 **Max Battery**

Windows XP controls the performance level of the processor depending on the power scheme you select. You do not need to make any further adjustments to set the performance level. Each preset power scheme has different time-out settings for entering standby mode, turning off the display, and turning off the hard drive. For more information on power management options, see the Windows XP Help and Support Center (*Windows Help* Windows 2000).

Alarms Tab

 **HINT:** To enable audible alarms, click each **Alarm Action** button and select **Sound alarm**.

The **Low battery alarm** and **Critical battery alarm** settings alert you with a message when the battery charge falls below a certain percentage. When you receive your computer, the **Low battery alarm** and **Critical battery alarm** check boxes are selected. Dell recommends that you continue to use these settings. See the battery section in the *Tell Me How* help file (see "[Accessing Help](#)") for more information on low-battery warnings.

Power Meter Tab

The **Power Meter** tab displays the current power source and amount of battery charge remaining.

Advanced Tab

The **Advanced** tab allows you to:

- 1 Set power icon and standby mode password options.
- 1 Depending on your operating system, program the following functions:
 - o Prompt user for an action (**Ask me what to do**).
 - o Activate standby mode.
 - o Activate hibernate mode.
 - o Shut down Windows and turn off the computer.
 - o Choose no action (**None** or **Do nothing**).

To program these functions, click an option from the corresponding pull-down menu, and then click **OK**.

Hibernate Tab

The **Hibernate** tab lets you enable hibernate mode by clicking the **Enable hibernate support** check box.

Intel SpeedStep® Technology Tab

 **HINT:** Windows XP controls the performance level of the processor depending on the power scheme that you select. See "[Power Schemes Tab](#)."

Depending on your operating system and microprocessor, the **Power Options Properties** window includes the **Intel SpeedStep® Technology** tab. The Intel SpeedStep technology allows you to set the performance level of the processor according to whether the computer is running on battery or AC power. Depending on your operating system, typical options are:

- 1 **Automatic** — The processor runs at its highest possible speed (Maximum Performance mode) when the computer is running on AC power. When the computer is running on battery power, the processor runs in Battery Optimized mode.

- 1 **Maximum Performance** — The processor runs at its highest possible speed even if the computer is running on battery power.
- 1 **Battery Optimized Performance** — Processor speed is optimized for battery power even if the computer is connected to an electrical outlet.

To change additional Intel SpeedStep options:

1. Click the **Advanced** button and then click one of the following options:
 - 1 **Disable Intel SpeedStep technology control**
 - 1 **Remove flag icon** (from the notification area)
 - 1 **Disable audio notification when performance changes**
2. Click **OK** to accept any changes, and then click **OK** to close the **Intel SpeedStep** window.

You can also change the Intel SpeedStep settings by right-clicking the flag icon in the notification area.

Battery Performance

Battery performance varies depending on operating conditions. The operating life of the battery is significantly reduced when you perform operations including, but not limited to, the following:

- 1 Using optical drives, especially DVD and CD-RW drives
 - 1 Using wireless communications devices, PC Cards, or USB devices
 - 1 Using high display-brightness settings, 3D screen savers, or other power-intensive programs such as 3D games
 - 1 Running power-intensive programs
 - 1 Running the computer in maximum performance mode
-

[Back to Contents Page](#)

Removing and Replacing Parts

Dell™ Inspiron™ 2600 and 2650

- [Before You Remove or Replace Parts](#)
- [System Components](#)
- [Hard Drive](#)
- [Back-Panel Fan \(Inspiron 2650 Only\)](#)
- [Memory Module, Modem, Optical Drive, and Floppy Drive](#)
- [Keyboard](#)
- [Display Assembly and Display Latch](#)
- [EMI Shield, Video Card, and Palm Rest](#)
- [Microprocessor Thermal-Cooling Assembly](#)
- [Microprocessor Module](#)
- [Speakers](#)
- [System Board](#)
- [Base Plastics](#)
- [Battery Latch Assembly](#)

[Back to Contents Page](#)

[Back to Contents Page](#)

System Setup Program

Dell™ Inspiron™ 2600 and 2650

- [System Setup Overview](#)
 - [Viewing the System Setup Screens](#)
 - [System Setup Screens](#)
-

System Setup Overview

The system setup program contains the standard settings for your computer.

- **NOTICE:** Unless you are an expert computer user or are directed to do so by Dell technical support, do not change the settings for this program. Certain changes might make your computer work incorrectly.
-

Viewing the System Setup Screens

1. Turn on (or restart) your computer.
2. When the Dell™ logo appears, press  immediately.

If you wait too long and the Windows logo appears, continue to wait until you see the Windows desktop. Then shut down your computer and try again.

Depending on your computer, you may also be able to enter the system setup program by pressing   at any time while the computer is running.

System Setup Screens

- **HINT:** To see information about a specific item on a system setup screen, highlight the item and refer to the **Help** area on the screen.

The system setup screens display the current setup information and settings for your computer. Each screen is laid out with the system setup options listed at the left. To the right of each option is a field that displays the setting or value for that option. You can change settings that appear as white type on the screen. Options or values that you cannot change (because they are determined by the computer) appear less bright.

A box in the upper-right corner of the screen displays help information for the currently highlighted option; a box in the lower-right corner displays information about the computer. System setup key functions are listed across the bottom of the screen.

The screens are titled as follows:

- 1 **Main**
- 1 **System devices**
- 1 **Security**
- 1 **Boot**
- 1 **Exit**

- **HINT:** Certain options require that you reboot the computer for new settings to take effect.

Press  to save and exit the system setup program and restart your computer.

[Back to Contents Page](#)

[Back to Contents Page](#)

Solving Problems

Dell™ Inspiron™ 2600 and 2650

- [Accessing Help](#)
- [Power Problems](#)
- [Error Messages](#)
- [Video and Display Problems](#)
- [Sound and Speaker Problems](#)
- [Printer Problems](#)
- [Modem and Internet Connection Problems](#)
- [Scanner Problems](#)
- [PC Card Problems](#)
- [Touch Pad or Mouse Problems](#)
- [External Keyboard Problems](#)
- [Unexpected Characters](#)
- [Drive Problems](#)
- [Network Problems](#)
- [General Program Problems](#)
- [E-Mail Problems](#)
- [If Your Computer Gets Wet](#)
- [If You Drop or Damage Your Computer](#)
- [Resolving Other Technical Problems](#)

Accessing Help

To access the *Tell Me How* help file

Microsoft® Windows® XP

1. Click the **Start** button and then click **Help and Support**.
2. Click **User and system guides** and then click **User's guides**.
3. Click **Tell Me How**.

Windows 2000

1. Click the **Start** button, point to **Programs**, and point to **User's Guides**.
2. Click **Tell Me How**.

To access Help in Windows XP

1. Click the **Start** button and then click **Help and Support**.
2. Type a word or phrase that describes your problem and then click the arrow icon.
3. Click the topic that describes your problem.
4. Follow the instructions shown on the screen.

To access Help in Windows 2000

1. Click the **Start** button and then click **Help**.
2. Click the **Search** tab.
3. Type a word or phrase that describes your problem and then click **List Topics**.
4. Click the topic that describes your problem and then click **Display**.
5. Follow the instructions shown on the screen.

Power Problems

 **HINT:** See the *Tell Me How* help file for information on standby mode (see "[Accessing Help](#)").

Check the power light — When the power light is lit or blinking, the computer has power. If the power light is blinking, the computer is in standby mode—press the power button to exit standby mode. If the light is off, press the power button to turn on the computer.

Charge the battery — The battery charge may be depleted.

1. Reinstall the battery.
2. Use the AC adapter to connect the computer to an electrical outlet.
3. Turn on the computer.

Check the battery status light — If the battery status light flashes orange or is a steady orange, the battery charge is low or depleted. Connect the computer to an electrical outlet.

If the battery status light is off, the battery is too hot to charge. Turn off the computer, disconnect the computer from the electrical outlet, and then let the battery and computer cool to room temperature.

If the battery status light rapidly flashes orange, the battery may be defective. For technical assistance (see "Contacting Dell" in the Dell *Owner's Manual* that came with your computer).

Test the electrical outlet — Ensure that the electrical outlet is working by testing it with another device, such as a lamp.

Check the AC adapter — Check the AC adapter cable connections. If the AC adapter has a light, ensure that the light is on.

Connect the computer directly to an electrical outlet — Bypass power protection devices, power strips, and the extension cable to verify

that the computer turns on.

Eliminate possible interference — Turn off nearby fans, fluorescent lights, halogen lamps, or other appliances.

Adjust the power properties — See the *Tell Me How* help file or search for the keyword *standby* in the Help and Support Center (*Help* in Windows 2000). See "[Accessing Help](#)."

Reset the memory modules — If your computer has 192 MB or more of RAM and the computer power light turns on but the display remains blank, reseat the memory modules. If your computer has less than 192 MB of RAM, you do not need to reseat the module.

To check how many MB of RAM your computer has:

- 1 In *Windows XP*, click **Computer Information**.
- 1 In *Windows 2000*, right-click the **My Computer** icon on your desktop, and then click the **General** tab.

Error Messages

If the message is not listed, see the documentation for the operating system or the program that was running at the time the message appeared.

Decreasing available memory — Your memory module may be faulty or improperly seated. If your computer has 192 MB or more of RAM, reseat the memory modules and, if necessary, replace it. If your computer has less than 192 MB of RAM, you do not need to reseat the module.

To check how many MB of RAM your computer has:

- 1 In *Windows XP*, click **Computer Information**.
- 1 In *Windows 2000*, right-click the **My Computer** icon on your desktop, and then click the **General** tab.

The file being copied is too large for the destination drive — The file that you are trying to copy is too large to fit on the disk, or the disk is too full. Try copying the file to a different disk or use a larger capacity disk.

Insert bootable media — The operating system is trying to boot to a nonbootable floppy disk or CD. Insert a bootable floppy disk or CD.

Non-system disk or disk error — A floppy disk is in the floppy drive. Remove the floppy disk and restart the computer.

Operating system not found — Contact Dell for technical assistance (see "Contacting Dell" in the *Dell Owner's Manual* that came with your computer).

A required .DLL file was not found — The program that you are trying to open is missing an essential file. Remove and then reinstall the program.

Microsoft® Windows® XP

1. Click the **Start** button.
2. Click **Control Panel**.
3. Click **Add or Remove Programs**.
4. Select the program you want to remove.
5. Click the **Change or Remove Program** icon.
6. See the program documentation for installation instructions.

Windows 2000



1. Click the **Start** button, point to **Settings**, and then click **Control Panel**.
2. Double-click the **Add/Remove Programs** icon.
3. Select the program that you want to remove.
4. Click **Change or Remove Programs** and follow the prompts on the screen.
5. See the program documentation for installation instructions.

x:\ is not accessible. The device is not ready — Insert a disk into the drive and try again.

Video and Display Problems

If the display is blank

 **HINT:** If you are using a program that requires a higher resolution than your computer supports, Dell recommends that you attach an external monitor to your computer.

Check the  light — When the  light is blinking, the computer has power.



If the  light is blinking, the computer is in standby mode—press the power button to exit standby mode.

If the  light is off, press the power button.

If the  light is on, your power management settings may have caused the display to turn off. Try pressing any key or move the cursor to exit standby mode.

Check the battery — If you are using a battery to power your computer, the battery charge may be depleted. Connect the computer to an electrical outlet using the AC adapter, and turn on the computer.

Test the electrical outlet — Ensure that the electrical outlet is working by testing it with another device, such as a lamp.

Check the AC adapter — Check the AC adapter cable connections. If the AC adapter has a light, ensure that it is on.
Connect the computer directly to an electrical outlet — Bypass power protection devices, power strips, and the extension cable to verify that the computer turns on.
Adjust the Power Properties — See the <i>Tell Me How</i> help file or search for the keyword <i>standby</i> in the Help and Support Center (<i>Help</i> in Windows 2000). See " Accessing Help ."
Switch the video image — If your computer is attached to an external monitor, press   to switch the video image to the display.

If the display is difficult to read



Adjust the brightness — See the <i>Tell Me How</i> help file for instructions on adjusting the brightness (see " Accessing Help ").
Move the subwoofer away from the computer or monitor — If your external speaker system includes a subwoofer, ensure that the subwoofer is at least 60 cm (2 ft) away from the computer or external monitor.
Eliminate possible interference — Turn off nearby fans, fluorescent lights, halogen lamps, or other appliances.
Rotate the computer to face a different direction — Eliminate sunlight glare, which can cause poor picture quality.
Adjust the Windows display settings
<i>Windows XP</i>
<ol style="list-style-type: none"> 1. Click the Start button and then click Control Panel. 2. Click Appearance and Themes. 3. Click the area you want to change or click the Display icon. 4. Try different settings for Color quality and Screen resolution.
<i>Windows 2000</i>
<ol style="list-style-type: none"> 1. Click the Start button, point to Settings, and then click Control Panel. 2. Double-click the Display icon and then click the Settings tab. 3. Try different settings for Colors, Screen area, and Advanced Settings.
See "Error Messages" — If an error message appears, see " Error Messages ."

If only part of the display is readable

Connect an external monitor
<ol style="list-style-type: none"> 1. Turn off your computer and connect an external monitor to the computer. 2. Turn on the computer and the monitor and adjust the monitor brightness and contrast controls.
If the external monitor works, the computer display or video controller may be defective. Contact Dell for technical assistance (see "Contacting Dell" in the <i>Dell Owner's Manual</i> that came with your computer).

Sound and Speaker Problems

If you have a problem with integrated speakers

Adjust the Windows® volume control — Double-click the speaker icon in the lower-right corner of your screen. Ensure that the volume is turned up and that the sound is not muted. Adjust the volume, bass, or treble controls to eliminate distortion.
Adjust the volume using keyboard shortcuts — Press   to disable (mute) or reenable the integrated speakers.
Reinstall the sound (audio) driver — See " Reinstalling Drivers and Utilities ."

If you have a problem with external speakers

 **HINT:** The volume control in some MP3 players overrides the Windows volume setting. If you have been listening to MP3 songs, make sure that you did not turn the player volume down or off.

Check the speaker cable connections — See the setup diagram supplied with the speakers.
Test the electrical outlet — Ensure that the electrical outlet is working by testing it with another device, such as a lamp.
Ensure that the speakers are turned on — See the setup diagram supplied with the speakers.
Adjust the Windows volume control — Double-click the speaker icon in the lower-right corner of your screen. Ensure that the volume is turned up and that the sound is not muted. Adjust the volume, bass, or treble controls to eliminate distortion.
Test the speakers — Plug the speaker audio cable into the line-out connector on the computer. Ensure that the headphone volume control is turned up. Play a music CD.
Run the speaker self-test — Some speaker systems have a self-test button on the subwoofer. See the speaker documentation for self-test

instructions.

Eliminate possible interference — Turn off nearby fans, fluorescent lights, or halogen lamps to check for interference.

Reinstall the sound (audio) driver — See "[Reinstalling Drivers and Utilities](#)."

Printer Problems

Check the printer cable connections — Ensure that the printer cable is properly connected to the computer.

Test the electrical outlet — Ensure that the electrical outlet is working by testing it with another device, such as a lamp.

Ensure that the printer is turned on — See the documentation supplied with the printer.

Verify that Windows® recognizes the printer

Windows XP

1. Click the **Start** button.
2. Click **Control Panel**.
3. Click **Printers and Other Hardware**.
4. Click **View installed printers or fax printers**. If the printer model is listed, right-click the printer icon.
5. Click **Properties** and then click the **Ports** tab.
6. Ensure that the **Print to the following port(s)** setting is set for your printer type:
 - 1 For a parallel printer: **LPT1 (Printer Port)**
 - 1 For a USB printer: **USB**

Windows 2000

1. Click the **Start** button, point to **Settings**, and then click **Printers**.

If the printer model is listed, right-click the printer icon.
2. Click **Properties** and then click the **Ports** tab.
3. Ensure that the **Print to the following port:** option is set for your printer type:
 - 1 For a parallel printer: **LPT1 (Printer Port)**
 - 1 For a USB printer: **USB**

Reinstall the printer driver — See "[Reinstalling Drivers and Utilities](#)."

Modem and Internet Connection Problems

 **NOTICE:** Connect the modem to an analog telephone wall jack only. Connecting the modem to a digital telephone network damages the modem.

 **NOTICE:** Modem and network connectors look similar. Do not plug a telephone line into the network connector.

 **HINT:** If you can connect to your Internet service provider (ISP), your modem is functioning properly. If you are sure that your modem is working properly and you still experience problems, contact your ISP.

Check the telephone wall jack — Disconnect the telephone line from the modem and connect it to a telephone. Listen for a dial tone. Ensure that you have touchtone telephone service. Try connecting the modem to a different telephone wall jack. Slow connection speeds can be caused by telephone noise as well as by telephone line or network conditions. Contact your telephone company or network administrator for more information.

Connect the modem directly to the telephone wall jack — If you have other telephone devices sharing the line, such as an answering machine, fax machine, surge protector, or line splitter, then bypass them and use the telephone line to connect the modem directly to the telephone wall jack.

Check the connection — Verify that the telephone line is connected to the modem.

Check the telephone line — Try using a different telephone line. If you are using a line that is 3 m (10 ft) or more in length, try a shorter one.

Irregular dial tone — If you have voice mail service, you might hear an irregular dial tone when you have messages. Contact your telephone company for instructions on restoring a dial tone.

Turn off call waiting (catch-phone) — See your telephone directory for instructions on deactivating this feature. Then adjust the dial-up networking connection properties.

Windows® XP

1. Click the **Start** button and click **Control Panel**.
2. Click **Printers and Other Hardware**, click **Phone and Modem Options**, click the **Dialing Rules** tab, and then click **Edit...**
3. In the **Edit Location** window, ensure that **To disable call waiting, dial:** is checked, and then select the proper code as listed in your telephone directory.
4. Click **Apply** and click **OK**.
5. Close the **Phone and Modems Options** window.
6. Close the **Control Panel** window.

Windows 2000

1. Click the **Start** button, point to **Settings**, and then click **Control Panel**.
2. Double-click the **Modems** icon.
3. Click **Dialing Properties**.
4. Ensure that **To disable call waiting, dial:** is checked, and then select the proper code as listed in your telephone directory.
5. Click **Apply** and click **OK**.
6. Close the **Modems Properties** window.

7. Close the **Control Panel** window.

Verify that the modem is communicating with Windows

XP

1. Click the **Start** button and click **Control Panel**.
2. Click **Printers and Other Hardware** and click **Phone and Modem Options**.
3. Click the **Modems** tab.
4. Click the COM port for your modem.
5. Click **Properties**, click the **Diagnostics** tab, and then click **Query Modem** to verify that the modem is communicating with Windows.

If all commands receive responses, the modem is operating properly.

Windows 2000

1. Click the **Start** button, point to **Settings**, and then click **Control Panel**.
2. Double-click **Phone and Modem Options**.

If multiple entries for the same modem or modems are listed but not installed, delete the entries, restart the computer, and repeat steps 1 and 2.

3. Click the **Diagnostics** tab.
4. Click the COM port for your modem.
5. Click **Query Modem** to verify that the modem is communicating with Windows.

If all commands receive responses, the modem is operating properly.

Scanner Problems

Check the power cable connection — Ensure that the scanner power cable is firmly connected to a working electrical power source and that the scanner is turned on. If the device is plugged into a surge protector, try plugging it directly into an electrical outlet.

Check the scanner cable connection — Ensure that the scanner cable is firmly connected to the computer and to the scanner.

Unlock the scanner — Ensure that your scanner is unlocked if it has a locking tab or button.

Reinstall the scanner driver — See the scanner documentation for instructions.

PC Card Problems

Check the PC Card — Ensure that the PC Card is properly inserted into the connector.

Ensure that the card is recognized by Windows® — Double-click the **Safely Remove Hardware (Unplug or Eject Hardware in Windows 2000)** icon in the Windows taskbar. Ensure that the card is listed.

If you have problems with a Dell-provided PC Card — Contact Dell for technical assistance (see "Contacting Dell" in the *Dell Owner's Manual* that came with your computer).

If you have problems with a PC Card not provided by Dell — Contact the PC Card manufacturer.

Touch Pad or Mouse Problems

Check the touch pad settings

Windows® XP

1. Click the **Start** button, click **Control Panel**, and then click **Printers and Other Hardware**.
2. Click **Mouse**.
3. Try adjusting the settings.

Windows 2000

1. Click the **Start** button, point to **Settings**, and then click **Control Panel**.
2. Double-click the **Mouse** icon.
3. Try adjusting the settings.

Check the mouse cable — Shut down the computer. Disconnect the mouse cable and check it for damage. For PS/2 cables, check the cable connector for bent or broken pins. Firmly reconnect the cable.

If you are using a mouse extension cable, disconnect it and connect the mouse directly to the computer.

To verify that the problem is with the mouse, check the touch pad

1. Turn off the computer.
2. Disconnect the mouse.
3. Turn on the computer.
4. At the Windows desktop, use the touch pad to move the cursor around, select an icon, and open it.

If the touch pad operates correctly, the mouse may be defective.

Reinstall the touch pad driver — See "[Reinstalling Drivers and Utilities](#)."

External Keyboard Problems

 **HINT:** When you attach an external keyboard, the integrated keyboard remains fully functional.

Check the keyboard cable — Shut down the computer. Disconnect the keyboard cable and check it for damage. For PS/2 cables, check the cable connector for bent or broken pins. Firmly reconnect the cable.

If you are using a keyboard extension cable, disconnect it and connect the keyboard directly to the computer.

Check the external keyboard

1. Turn off the computer, wait 1 minute, and turn it on again.
2. Verify that the numbers, capitals, and scroll lock lights on the keyboard blink during the boot routine.
3. From the Windows® desktop, click the **Start** button, point to **Programs (All Programs in Windows XP)**, point to **Accessories**, and click **Notepad**.
4. Type some characters on the external keyboard and verify that they appear on the display.



If you cannot verify these steps, you may have a defective external keyboard.

To verify that the problem is with the external keyboard, check the integrated keyboard

1. Turn off the computer.
2. Disconnect the external keyboard.
3. Turn on the computer.
4. From the Windows desktop, click the **Start** button, point to **Programs**, point to **Accessories**, and click **Notepad**.
5. Type some characters on the integrated keyboard and verify that they appear on the display.

If the characters appear now but did not with the external keyboard, you may have a defective external keyboard. Contact Dell (see "Contacting Dell" in the *Dell Owner's Manual* that came with your computer).

Unexpected Characters

Press  to disable the numeric keypad. Verify that the numbers lock light  is not lit.

Drive Problems

 **HINT:** For information on saving files to a floppy disk, see the *Tell Me How* help file (see "[Accessing Help](#)").

If you cannot save a file to a floppy disk drive

Ensure that Windows® recognizes the drive — In *Windows XP*, click the **Start** button and click **My Computer**. In *Windows 2000*, double-click **My Computer**. If the drive is not listed, perform a full scan with your antivirus software to check for and remove viruses. Viruses can sometimes prevent Windows from recognizing the drive. Insert a bootable disk and restart the computer. Verify that the  light is blinking, indicating normal operation.

Ensure that the disk is not write-protected — You cannot save data to a write-protected disk. See the following figure.



Try another floppy disk — Insert another disk to eliminate the possibility that the original disk is defective.

Check the drive for errors — If the drive is a fixed drive:

1. Remove the hard drive.
2. Insert the *Drivers and Utilities* CD for your computer and turn on the computer. Verify that the  light is blinking, indicating normal operation. If a drive error message appears, see "[Error Messages](#)" for an explanation.
3. Run the IDE tests. See "[Using the Dell Diagnostics](#)."

Clean the drive — See "Cleaning Your Computer" in the *Tell Me How* help file for instructions (see "[Accessing Help](#)").

If you cannot play a CD, CD-RW, or DVD

 **HINT:** Because of different worldwide file types, not all DVD titles work in all DVD drives.

High-speed CD drive vibration is normal and may cause noise. This noise does not indicate a defect with the drive or the CD.

Ensure that Windows® recognizes the drive — In *Windows XP*, click the **Start** button and click **My Computer**. In *Windows 2000*, double-click **My Computer**. If the drive is not listed, perform a full scan with your antivirus software to check for and remove viruses. Viruses can

sometimes prevent Windows from recognizing the drive. Insert a bootable disk and restart the computer. Verify that the  light is blinking, indicating normal operation.

Try another disc — Insert another disc to eliminate the possibility that the original disc is defective.

Adjust the Windows volume control — Double-click the speaker icon in the lower-right corner of your screen. Ensure that the volume is turned up and that the sound is not muted.

Clean the drive or disc — See "Cleaning Your Computer" in the *Tell Me How* help file for instructions (see "[Accessing Help](#)").

If you cannot eject the CD, CD-RW, or DVD drive tray

1. Ensure that the computer is turned off.
2. Straighten a paper clip and insert one end into the eject hole at the front of the drive; push firmly until the tray is partially ejected.
3. Gently pull out the tray until it stops.

If you hear an unfamiliar scraping or grinding sound

1. Ensure that the sound is not caused by the program that is running.
1. Ensure that the disk or disc is inserted properly.

If the CD-RW drive stops writing

Disable standby mode in Windows before writing to a CD-RW — See the *Tell Me How* help file or search for the keyword *standby* in the Windows XP Help and Support Center (*Help* in Windows 2000). See "[Accessing Help](#)."

Change the write speed to a slower rate — See the help files for your CD creation software.

Close all other open programs — Closing all other open programs before writing to the CD-RW may alleviate the problem.

If you have problems with a hard drive

Allow the computer to cool before turning it on — A hot hard drive may prevent the operating system from starting. Try allowing the computer to return to room temperature before turning it on.

Check the drive for errors

1. In *Windows XP*, click the **Start** button and click **My Computer**. In *Windows 2000*, double-click **My Computer**.
2. Right-click the drive letter (local disk) that you want to scan for errors, and then click **Properties**.
3. Click the **Tools** tab.
4. Under **Error-checking**, click **Check Now**.
5. Click **Start**.
6. Run the IDE Drive tests. See [Using the Dell Diagnostics](#)."

Network Problems

Check the network cable connector — Ensure that the network cable connector is firmly connected to the connector on the computer and the network wall jack.

Check the network lights on the network connector — Green indicates that the network connection is active. If the status light is not green, try replacing the network cable. Amber indicates that the network adapter driver is loaded and the adapter is detecting activity.

Restart the computer — Try to log on to the network again.

Contact your network administrator — Verify that your network settings are correct and that the network is functioning.

General Program Problems

A program crashes

 **HINT:** Software usually includes installation instructions in its documentation or on a floppy disk or CD.

See the software documentation — Many software manufacturers maintain websites with information that may help you solve the problem. Ensure that you properly installed and configured the program. Reinstall the program if necessary.

A program stops responding

End the program

1. Simultaneously press   .
2. Click the **Applications** tab, and then select the program that is no longer responding.
3. Click **End Task**.

A solid blue screen appears

Turn the computer off — If the computer does not respond to a keystroke or a proper shutdown, press the power button until the computer turns off. Press the power button again to restart the computer. The solid blue screen appears because you were not able to perform a proper Windows® shutdown. ScanDisk automatically runs during the start-up process. Follow the instructions on the screen.

Error messages appear

Review "Error Messages" — Look up the message and take the appropriate action. See the software documentation.

E-Mail Problems

Ensure that you are connected to the Internet — With the Outlook Express e-mail program open, click **File**. If **Work Offline** has a check mark next to it, click the check mark to remove it and connect to the Internet.

Be sure that you have subscribed to an Internet service provider — Contact an Internet service provider to subscribe.

Contact your Internet service provider — Contact your Internet service provider for assistance.

If Your Computer Gets Wet

 **CAUTION:** Perform this procedure only after you are certain that it is safe to do so. If the computer is connected to an electrical outlet, Dell recommends that you turn off AC power at the circuit breaker before attempting to remove the power cables from the electrical outlet. Use the utmost caution when removing wet cables from a live power source.

1. Turn off the computer (see "[Accessing Help](#)"), disconnect the AC adapter from the computer, and then disconnect the AC adapter from the electrical outlet.
2. Turn off any attached external devices, and disconnect them from their power sources and then from the computer.
3. Ground yourself by touching one of the metal connectors on the back of the computer.
4. Remove any installed PC Cards, and put them in a safe place to dry.
5. Remove the battery.
6. Wipe off the battery and put it in a safe place to dry.
7. Remove the hard drive.
8. Remove the memory module.
9. Open the display and place the computer right-side up across two books or similar props to let air circulate all around it. Let the computer dry for at least 24 hours in a dry area at room temperature.

 **NOTICE:** Do not use artificial means, such as a hair dryer or a fan, to speed the drying process.

 **CAUTION:** To help prevent electrical shock, verify that the computer is thoroughly dry before continuing with the rest of this procedure.

10. Ground yourself by touching one of the metal connectors on the back of the computer.
11. Replace the memory module, the memory module cover, and the screw.
12. Replace the hard drive.
13. Replace any PC Cards you removed.
14. Replace the battery.
15. Turn on the computer and verify that it is working properly.

If the computer does not start, or if you cannot identify the damaged components, contact Dell for technical assistance (see "Contacting Dell" in the Dell *Owner's Manual* that came with your computer).

If You Drop or Damage Your Computer

1. Save and close any open files, exit any open programs, and shut down the computer.
2. Disconnect the AC adapter from the computer and from the electrical outlet.
3. Turn off any attached external devices, and disconnect them from their power sources and then from the computer.
4. Remove and reinstall the battery.
5. Turn on the computer.

 **HINT:** See "Limited Warranties and Return Policy" in the Dell *Owner's Manual* that came with your computer for information on your warranty coverage.

If the computer does not start, or if you cannot identify the damaged components, contact Dell for technical assistance (see "Contacting Dell" in the Dell *Owner's Manual* that came with your computer).

Resolving Other Technical Problems

Go to the Dell Support website — Go to support.dell.com for help with general usage, installation, and troubleshooting questions. See "Dell Technical Support Policy (U.S. Only)" in the *Owner's Manual* that came with your computer for a description of the hardware and software support provided by Dell.

E-mail Dell — Go to support.dell.com and then click **E-Mail Dell** in the **Communicate** list. Send an e-mail message to Dell about your problem; you can expect to receive an e-mail message from Dell within hours. See "Dell Technical Support Policy (U.S. Only)" in the *Owner's Manual* that came with your computer for a description of the hardware and software support provided by Dell.

Contact Dell — If you cannot solve your problem using the Dell Support website or e-mail service, call Dell for technical assistance (see "Contacting Dell" in the Dell *Owner's Manual* that came with your computer). See "Dell Technical Support Policy (U.S. Only)" in the *Owner's Manual* that came with your computer for a description of the hardware and software support provided by Dell.

[Back to Contents Page](#)

Speakers

Dell™ Inspiron™ 2600 and 2650

- [Removing the Speakers](#)
- [Replacing the Speakers](#)

Removing the Speakers

- ➔ **NOTICE:** Disconnect the computer and any attached devices from electrical outlets, and remove any installed battery.
- ➔ **NOTICE:** To avoid ESD, ground yourself by using a wrist grounding strap or by touching an unpainted metal surface on the computer.
- ➔ **NOTICE:** Read "[Preparing to Work Inside the Computer](#)" before performing the following procedure.

The speakers are located on the left and right corners of the front of the bottom case. Take note of the speaker cable routing so that you can replace the cables properly under or between their routing clips.

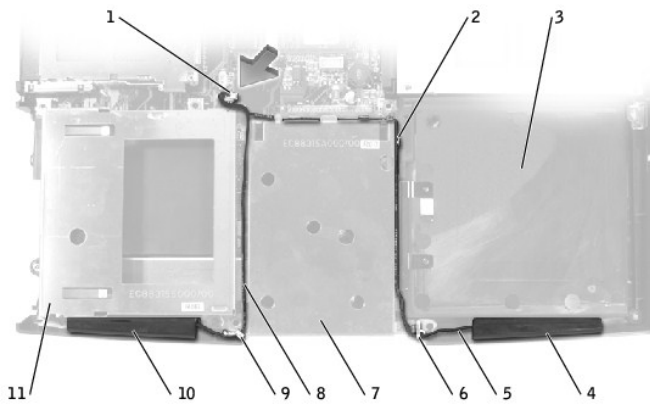

1	speaker connector	7	hard drive cage
2	routing clips (10)	8	left speaker cable
3	battery bay	9	left die casting
4	right speaker	10	left speaker
5	right speaker cable	11	floppy drive cage
6	right die casting		

1. Remove the [hard drive](#).
2. Remove the [floppy drive](#).
3. Remove the [keyboard](#).
4. Remove the [display assembly](#).
5. Remove the [EMI shield](#).
6. Remove the [video card](#).
7. Remove the [palm rest](#).
8. Disconnect the speaker connector from the system board.
- ➔ **NOTICE:** Remove the speaker cables from their routing clips and die casting with care to avoid damaging the cables.
9. Remove the speaker cables from under or between their routing clips and die casting.
- ➔ **NOTICE:** Handle the speakers with care to avoid damaging them.
10. Remove the speakers by pulling them straight up and out of the bottom case.

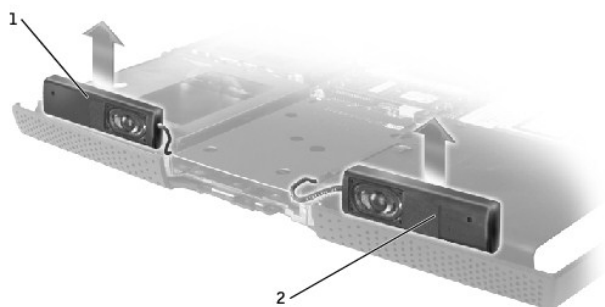



1	left speaker
2	right speaker

Replacing the Speakers

1. Slide the speakers down into the bottom case.

 **NOTICE:** Ensure that the speaker cables are under or between their routing clips, and route the left and right speaker cables properly beneath the die casting.

 **HINT:** Speakers face out in the bottom case holders.

 **HINT:** The right speaker cable is longer than the left speaker cable.

2. Route the speaker cables under or between their routing clips.
3. Connect the speaker connector to the system board.

[Back to Contents Page](#)

[Back to Contents Page](#)

Specifications

Dell™ Inspiron™ 2600 and 2650

- [Microprocessor](#)
- [System Information](#)
- [PC Card](#)
- [Memory](#)
- [Ports and Connectors](#)
- [Communications](#)
- [Video](#)
- [Display](#)
- [Touch Pad](#)
- [Battery](#)
- [AC Adapter](#)
- [Physical](#)
- [Environmental](#)

Microprocessor	
Microprocessor type:	
Inspiron™ 2650	Mobile Intel® Pentium® 4 processor
Inspiron 2600	Mobile Intel Pentium III processor-M or Mobile Intel Celeron® processor
L1 cache	32 KB (Internal)
L2 cache	512 KB (Intel Pentium 4 and Intel Pentium III); 256 KB (Intel Celeron)
External bus frequency:	
Inspiron 2650	400 MHz
Inspiron 2600	133 MHz

System Information	
System chip set:	
Inspiron 2650	Intel 845MZ
Inspiron 2600	Intel 830MG
Data bus width	64 bits
DRAM bus width	64 bits
Microprocessor address bus width	32 bits
Flash EPROM:	
Inspiron 2650	39F040 (512 KB / 8-bit data bus)
Inspiron 2600	28F040 (512 KB / 8-bit data bus)
Graphics bus	integrated graphics
PCI bus	standard 32-bit PCI bus

PC Card	
CardBus controller	O2 Micro OZ6912
PC Card connector	supports one Type I or Type II card
Cards supported	3.3 V and 5 V
PC Card connector size	68 pins
Data width (maximum)	PCMCIA 16 bits CardBus 32 bits

Memory	
Architecture:	
Inspiron 2650	DDR200 3.3V DDR
Inspiron 2600	PC133 SDRAM
Memory module connector	one user-accessible SODIMM sockets
Memory module capacities	128 and 256 MB
Memory type	3.3-V SODIMM
Standard memory	128 MB
Maximum memory	512 MB

Ports and Connectors	
-----------------------------	--

Parallel	25-hole connector; unidirectional, bidirectional, or ECP
Video	15-hole connector
Audio	microphone connector, stereo headphone/speakers connector
PS/2 keyboard/mouse	6-pin mini-DIN connector
USB (2)	4-pin USB-compliant connector
Modem	RJ-11 connector
Ethernet LAN	RJ-45 connector (optional)

Communications	
Modem:	
Type	v.92 56K MDC
Controller	softmodem
Interface	internal AC 97 bus
Network adapter	10/100 Ethernet LAN on system board

Video	
Video type:	
Inspiron 2650	external 4x AGP discreet graphic solution NV11
Inspiron 2600	direct AGP integrated graphics
Data bus:	
Inspiron 2650	external 4x AGP
Inspiron 2600	UMA
Video controller:	
Inspiron 2650	NVIDIA GeForce2 Go 100
Inspiron 2600	Intel 830 MG
Video memory:	
Inspiron 2650	8 MB or 16 MB, external DDR
Inspiron 2600	
System memory 128 MB	UMA: shared with system memory up to 32 MB
System memory 256 MB	UMA: shared with system memory up to 48 MB
LCD interface	SPWG

Display	
Type (active-matrix TFT)	XGA
Dimensions:	14.1 inch or 15 inch
Height:	
14.1 inch	215.8 mm (8.5 inches)
15 inch	229.7 mm (9 inches)
Width:	
14.1 inch	287.1 mm (11.3 inches)
15 inch	305.7 mm (12 inches)
Diagonal:	
14.1 inch	359.16 mm (14.1 inches)
15 inch	382.4 mm (15.1 inches)
Maximum resolutions	1024 x 768 at 16.8 million colors
Response time (typical)	20-ms rise (maximum), 30-ms fall (maximum)
Refresh rate	60 Hz
Refresh rate	60 Hz
Operating angle	0° (closed) to 180°

Viewing angles:	
Horizontal	±40°
Vertical	+10°/-30°
Pixel pitch	0.28 x 0.28 mm
Power consumption:	
Panel with backlight (typical)	6.5 W

Touch Pad	
X/Y position resolution (graphics table mode)	240 cpi
Size:	
Width	64.88 mm (2.55-inch) sensor-active area
Height	48.88-mm (1.92-inch) rectangle

Battery	
Type	8-cell (59 WHr) "smart" lithium ion
Dimensions:	
Depth	88.5 mm (3.48 inches)
Height	21.5 mm (0.83 inch)
Width	139.0 mm (5.47 inches)
Weight	0.40 kg (0.88 lb) (8 cell)
Voltage	14.8 VDC
Operating life	2 to 4 hours with average usage of 8-cell battery; can be significantly reduced under certain power intensive conditions
Life span (approximate)	400 discharge/charge cycles ⁰
Temperature range:	
Operating	0° to 35°C (32° to 95°F)
Storage	-40° to 65°C (-40° to 149°F)

AC Adapter	
Input voltage	90 to 264 VAC
Input current (maximum)	1.5 A
Input frequency	47 to 63 Hz
Output current	4.5 A (maximum at 4-second pulse); 3.5 A (continuous)
Output power	70 W standard
Rated output voltage	20 VDC
Dimensions:	
Height	27.94 mm (1.1 inches)
Width	58.42 mm (2.3 inches)
Depth	133.85 mm (5.25 inches)
Weight (with cables)	0.4 kg (0.9 lb)
Temperature range:	
Operating	0° to 35°C (32° to 95°F)
Storage	-40° to 65°C (-40° to 149°F)

Physical	
Height:	
With 14.1-inch or 15-inch display	37 mm (1.45 inches)
Width:	
With 14.1-inch display	328 mm (12.9 inches)
With 15-inch display	332 mm (13.1 inches)
Depth	274 mm (10.8 inches)
Weight: (with CD drive, floppy drive, and battery)	
14.1-inch display	3266 g (7.2 lb)
15-inch display	3561 g (7.85 lb)

Environmental	
----------------------	--

Temperature range:	
Operating	0° to 35°C (32° to 95°F)
Storage	-40° to 65°C (-40° to 149°F)
Relative humidity (maximum):	
Operating	10% to 90% (noncondensing)
Storage	5% to 95% (noncondensing)
Maximum vibration:	
Operating	0.9 GRMS
Storage	1.3 GRMS
Maximum shock (measured with the hard drive in head-parked position and 2-ms half-sine pulse):	
Operating	122 G
Storage	163 G
Altitude (maximum):	
Operating	-15.2 to 3048 m (-50 to 10,000 ft)
Storage	-15.2 to 10,668 m (-50 to 35,000 ft)

[Back to Contents Page](#)

System Board

Dell™ Inspiron™ 2600 and 2650

- [Removing the System Board](#)
- [Replacing the System Board](#)

Removing the System Board

- ➔ **NOTICE:** For Inspiron 2650 computers only, prior to replacing the system board, ensure that a [thermal pad](#) is present on the Memory Controller Hub (MCH) heat sink, located on the base plastics. If a thermal pad is already present, you do not need to replace it.

The system board's BIOS chip contains the service tag sequence, which is also visible on a barcode label on the bottom of the computer. The replacement kit for the system board includes a CD that provides a utility for transferring the service tag sequence to the replacement system board.

- ➔ **NOTICE:** Disconnect the computer and any attached devices from electrical outlets, and remove any installed battery.
- ➔ **NOTICE:** To avoid ESD, ground yourself by using a wrist grounding strap or by touching an unpainted metal surface on the computer.
- ➔ **NOTICE:** Read "[Preparing to Work Inside the Computer](#)" before performing the following procedure.

1. Remove the [hard drive](#).
2. Remove the [optical drive](#).
3. Remove the [floppy drive](#).
4. Remove the [memory module](#).
5. Remove the [modem](#).
6. Remove the [keyboard](#).
7. Remove the [display assembly](#).
8. Remove the [EMI shield](#).
9. Remove the [video card](#).
10. Remove the [palm rest](#).
11. Remove the [microprocessor thermal-cooling assembly](#).
12. Remove the [microprocessor](#).
13. Remove the [speakers](#).

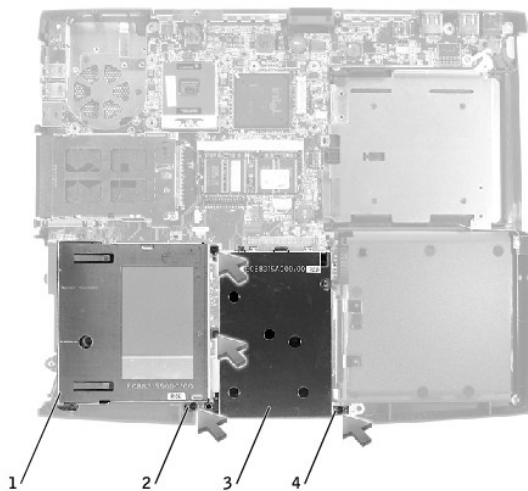

1	floppy drive cage
2	M2.5 x 5-mm screws (2)

3	hard drive cage
4	M2.5 x 5-mm screws (2)

14. Remove the two M2.5 x 5-mm screws that secure the floppy drive cage to the system board, and lift the floppy drive cage out of the bottom case.
15. Remove the two M2.5 x 5-mm screws that secure the hard drive cage to the system board, and lift the hard drive cage out of the bottom case.

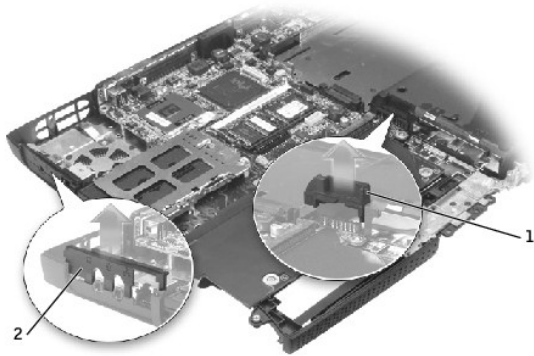

1	battery connector cover
2	headphone/microphone bridge

16. Remove the battery connector cover by lifting the cover out of the bottom case.
17. Remove the headphone/microphone connector cover by lifting the cover out of the bottom case.

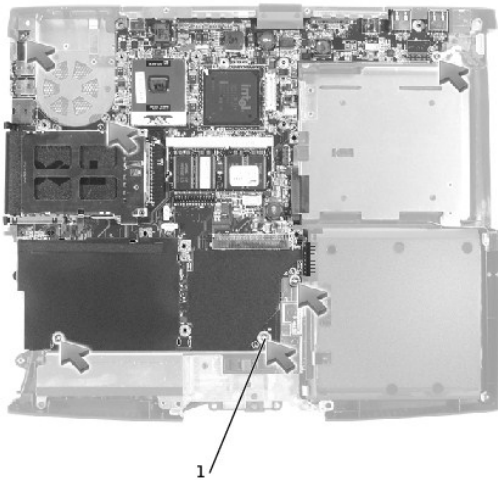

1	M2.5 x 4-mm screws (6)
---	------------------------

 **HINT:** The M2.5 x 4-mm screws are silver.

18. Remove the six M2.5 x 4-mm screws labeled "circle L" that secure the system board to the bottom case.

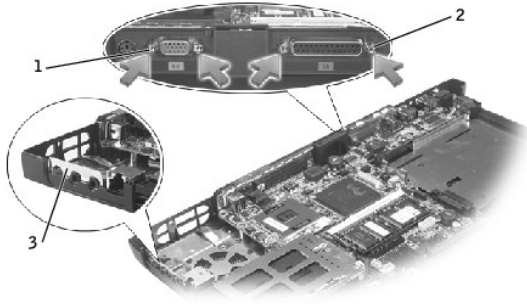

1	video-connector hex nuts
2	parallel-connector hex nuts
3	headphone/microphone flex-panel

19. Remove the two hex nuts that secure the video connector to the bottom case.
20. Remove the two hex nuts that secure the parallel connector to the bottom case.
21. Pull the headphone/microphone flex-panel away from the system board as you simultaneously lift the front of the system board out and away from the bottom case.

Replacing the System Board

NOTICE: For Inspiron 2650 computers only, prior to replacing the system board, ensure that a [thermal pad](#) is present on the Memory Controller Hub (MCH) heat sink, located on the base plastics. If a thermal pad is already present, you do not need to replace it.

1. Install the replacement system board:
 - a. Insert the video connector through the back of the bottom case.
 - b. Pull the headphone and microphone flex-panel away from the system board as you simultaneously lower the front of the system board into the bottom case.
 - c. Press the flex panel toward the headphone and microphone connectors, and insert the bridge into the bottom case.
 - d. Reinstall the two hex nuts that secure the parallel connector to the bottom case.
 - e. Reinstall the two hex nuts that secure the video connector to the bottom case.

NOTICE: Secure the modem-cable grounding terminal to the system board with one of the six M2.5 x 4-mm screws labeled "circle L." Failure to do so may result in damage to the computer.

HINT: The M2.5 x 4-mm screws are silver.

- f. Reinstall the six M2.5 x 4-mm screws labeled "circle L," starting on the right side of the bottom case.

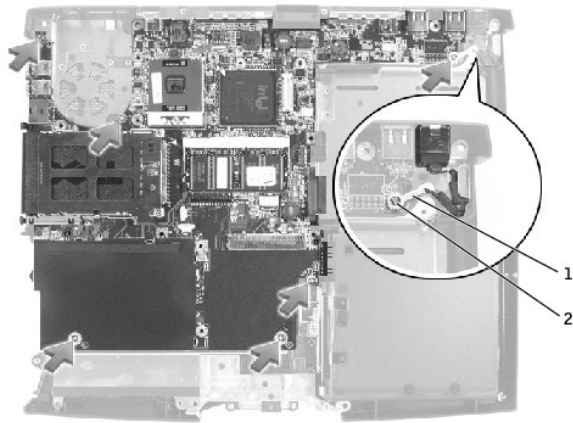

1	modem-cable grounding terminal
2	M2.5 x 4-mm screws (6)

- g. Reinstall the hard drive cage, and reinstall the two M2.5 x 5-mm screws that secure the hard drive cage to the system board.
- h. Reinstall the floppy drive cage, and reinstall the two M2.5 x 5-mm screws that secure the floppy drive cage to the system board.

2. Replace the [speakers](#).
3. Replace the [microprocessor](#) and the [microprocessor thermal-cooling assembly](#) that you removed from the old system board.

➔ **NOTICE:** Route cables so that they will not be crimped or pinched when the complete assembly is put back together.

4. Replace the [palm rest](#).
5. Replace the [video card](#) and the [EMI shield](#) that you removed from the old system board.
6. Replace the [display assembly](#) and the [keyboard](#).
7. Replace the [floppy drive](#), [optical drive](#), [modem](#), [memory module](#), and [hard drive](#).
8. If applicable, replace the PC Card in the PC Card slot.
9. Replace the battery.
10. Connect the AC adapter to your computer and to an electrical outlet.

➔ **NOTICE:** Before turning on the computer, replace all screws and ensure that no stray screws remain inside the computer. Failure to do so may result in damage to the computer.

🔧 **HINT:** After replacing the system board, enter the computer service tag sequence into the BIOS of the replacement system board.

11. Turn on the computer.
12. Insert the floppy disk or CD that accompanied the replacement system board into the appropriate drive, and turn on the computer. Follow the instructions on the screen.

System Components

Dell™ Inspiron™ 2600 and 2650

- ➔ **NOTICE:** Only a certified service technician should perform repairs on your computer. Damage due to servicing that is not authorized by Dell is not covered by your warranty.
- ➔ **NOTICE:** Unless otherwise noted, each procedure in this document assumes that a part can be replaced by performing the removal procedure in reverse order.

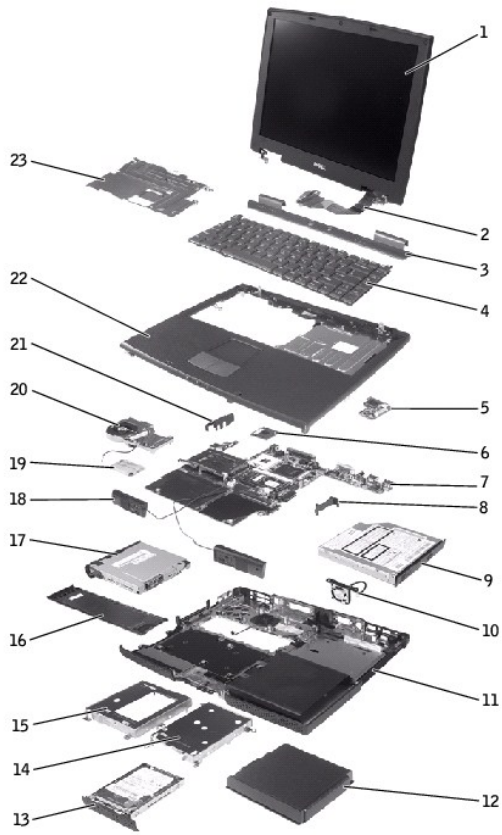

1	display assembly	13	hard drive
2	display-feed flex cable	14	hard drive cage
3	center control cover	15	floppy drive cage
4	keyboard	16	memory module/modem cover
5	video card	17	floppy drive
6	microprocessor module	18	speaker
7	system board	19	modem
8	battery connector cover	20	microprocessor thermal-cooling assembly
9	optical drive	21	headphone/microphone bridge
10	back-panel fan (Inspiron 2650 only)	22	palm rest
11	bottom case	23	EMI shield
12	battery		

[Back to Contents Page](#)

Microprocessor Thermal-Cooling Assembly

Dell™ Inspiron™ 2600 and 2650

- [Removing the Microprocessor Thermal-Cooling Assembly](#)
- [Replacing the Microprocessor Thermal-Cooling Assembly](#)

Removing the Microprocessor Thermal-Cooling Assembly

- ➔ **NOTICE:** Disconnect the computer and any attached devices from electrical outlets, and remove any installed battery.
- ➔ **NOTICE:** To avoid ESD, ground yourself by using a wrist grounding strap or by touching an unpainted metal surface on the computer.
- ➔ **NOTICE:** Read "[Preparing to Work Inside the Computer](#)" before performing the following procedure.

1. Remove the [keyboard](#).
2. Remove the [EMI shield](#).

🔍 **HINT:** You can remove the microprocessor thermal-cooling assembly with the fan attached.

3. Disconnect the fan power cable from the system board.
4. Loosen in consecutive order the four captive screws, labeled "1" through "4," that secure the microprocessor thermal-cooling assembly to the system board.

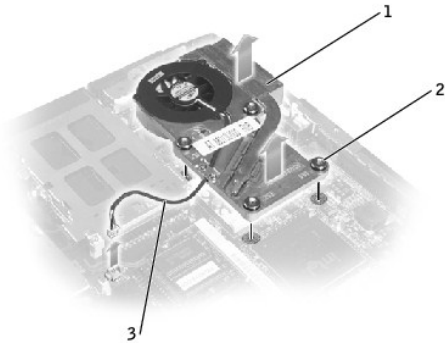

1	microprocessor thermal-cooling assembly
2	captive screws (4)
3	fan power cable

5. Lift the microprocessor thermal-cooling assembly up toward the front of the computer and out of the system board.

Replacing the Microprocessor Thermal-Cooling Assembly

1. Place the back of the microprocessor thermal-cooling assembly under the palm rest and lower the assembly onto the system board.
2. Tighten the four captive screws, labeled "1" through "4," in consecutive order.

[Back to Contents Page](#)

A Tour of Your Computer

Dell™ Inspiron™ 2600 and 2650

- [Front View](#)
 - [Left Side View](#)
 - [Right Side View](#)
 - [Back View](#)
 - [Bottom View](#)
-

Front View



1	display latch	7	device status lights
2	display	8	hard drive
3	Dell™ AccessDirect™ button	9	speaker
4	keyboard status lights	10	keyboard
5	touch pad	11	power button
6	touch pad buttons		



Display Latch — Keeps the display closed.

Display — For more information on using your color display, see "Using the Display" in the *Tell Me How* help file (see "Accessing Help").

Dell AccessDirect Button — Press this button to launch support and educational resources that Dell has installed on your computer.



Keyboard Status Lights — The green lights located above the keyboard indicate the following:





	Turns on when the numeric keypad is enabled
	Turns on when the uppercase letter function is enabled
	Turns on when the scroll lock function is enabled



Touch Pad — Use the touch pad and touch pad buttons as you would use a mouse.

Touch Pad Buttons — Correspond to the left and right buttons on a standard mouse.

Device Status Lights

	Turns on when you turn on the computer or flashes when the computer is in standby mode
	Turns on when the computer reads or writes data
	NOTICE: To avoid loss of data, never turn off the computer while the  light is flashing.
	Turns on steadily or blinks to indicate battery charge status

If the computer is connected to an electrical outlet, the  light operates as follows:

- 1 Solid green: The battery is fully charged.
- 1 Flashing green: The battery is charging.

If the computer is running on a battery, the  light operates as follows:

- 1 Off: The battery is adequately charged (or the computer is turned off).
- 1 Flashing orange: The battery charge is critically low.
- 1 Solid orange: The battery charge is low.



Hard Drive — Reads and writes data on a hard disk.

Speaker — Press the volume control buttons or volume control keyboard shortcuts to adjust the volume of the integrated speakers.

Keyboard — The keyboard includes a numeric keypad as well as the Microsoft® Windows® logo key .

Power Button — Press the power button to turn on the computer or to enter standby mode.

 **NOTICE:** Turn off your computer by performing a Windows shutdown rather than by pressing the power button. Otherwise, you may lose data.

Left Side View



1	audio connectors (2)
2	network connector
3	PC Card slot
4	floppy drive

Audio Connectors

Attach headphones or speakers to the  connector.

Attach a microphone to the  connector.



Network Connector (Optional)

 **HINT:** The network connector is slightly larger than the modem connector. Do not plug a telephone line into the network connector.

	<p>Connects the computer to a network. The lights next to the connector indicate activity for both wired and wireless network communications.</p> <p>For information on using the network adapter, see the online network adapter documentation supplied with your computer.</p>
---	--

PC Card Slot — Has one connector that supports various types of PC Cards, including modems and network adapters.

Floppy Drive — Reads and writes data to floppy disks.

Right Side View



1	security cable slot
2	fixed optical drive compartment

Security Cable Slot — Lets you attach a commercially available anti-theft device to the computer. Instructions for installing anti-theft devices are usually included with the device.

 **NOTICE:** Before you buy an anti-theft device, ensure that it will work with the security cable slot.



Fixed Optical Drive Compartment — Accommodates devices such as a CD drive, DVD drive, CD-RW drive, or a CD-RW/DVD combo drive.

Back View

 **NOTICE:** To avoid damaging the computer, wait 5 seconds after turning off the computer before you disconnect an external device.

 **CAUTION:** Do not block, push objects into, or allow dust to accumulate in the air vents. Doing so can damage the computer or cause a fire.

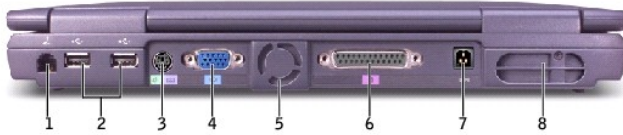

1	modem connector	5	air vents (for Inspiron 2650 only)
2	USB connectors (2)	6	parallel connector
3	PS/2 connector	7	AC adapter connector
4	video connector	8	air vents

Modem Connector

	<p>Connect the telephone line to the modem connector.</p> <p>For information on using the modem, see the online modem documentation supplied with your computer.</p>
---	--

USB Connectors

	Connects USB devices, such as a mouse, keyboard, or printer.
---	--

PS/2 Connector

 **HINT:** You can use the integrated keyboard and an external keyboard at the same time. When you attach a PS/2 keyboard or PS/2 numeric keypad, the integrated keypad is disabled.

	<p>Connects PS/2-compatible devices, such as a mouse, keyboard, or external numeric keypad.</p> <p>Shut down the computer before attaching or removing a PS/2-compatible device. If the device does not work, install the device drivers from the floppy disk or CD that came with the device, and restart the computer.</p>
---	--

Video Connector

	Connects an external monitor.
---	-------------------------------

Air Vents – The computer uses an internal fan to create airflow through the vents, which prevents the computer from overheating.

 **CAUTION:** Do not block, push objects into, or allow dust to accumulate in the air vents. Doing so can damage the computer or cause a fire.

 **HINT:** The computer turns on the fans when the computer gets hot. The fans may make noise, which is normal and does not indicate a problem with the fans or the computer.

Parallel Connector

	Connects a parallel device, such as a printer.
---	--

AC Adapter Connector – Allows you to attach an AC adapter to the computer. The AC adapter converts AC power to the DC power required by the computer. You can connect the AC adapter with your computer turned either on or off.



CAUTION: The AC adapter works with electrical outlets worldwide. However, power connectors and power strips vary among countries. Using an incompatible cable or improperly connecting the cable to the power strip or electrical outlet may cause fire or equipment damage.

NOTICE: When you disconnect the AC adapter from the computer, grasp the adapter cable connector, not the cable itself, and pull firmly but gently to avoid damaging the cable.

Bottom View



1	battery lock
2	battery release latch
3	battery
4	memory module cover
5	air vents

Battery Lock — Secures the battery.

Battery Release Latch — Press the release latch to remove the battery.

Battery — When a battery is installed, you can use the computer without connecting it to an electrical outlet.

Memory Module Cover — Covers the compartment that contains the memory module(s). See "[Memory Module](#)" for information on replacing and installing memory modules.

Air Vents — The computer uses an internal fan to create airflow through the vents, which prevents the computer from overheating.

CAUTION: Do not block, push objects into, or allow dust to accumulate in the air vents. Doing so can damage the computer or cause a fire.



HINT: The computer turns on the fans when the computer gets hot. The fans may make noise, which is normal and does not indicate a problem with the fans or the computer.

[Back to Contents Page](#)

[Back to Contents Page](#)

Dell™ Inspiron™ 2600 and 2650

Hints, Notices, and Cautions

-  **HINT:** A HINT indicates important information that helps you make better use of your computer.
 -  **NOTICE:** A NOTICE indicates either potential damage to hardware or loss of data and tells you how to avoid the problem.
 -  **CAUTION:** A CAUTION indicates a potential for property damage, personal injury, or death.
-

Abbreviations and Acronyms

For a complete list of abbreviations and acronyms, see the *Tell Me How* help file. See "[Accessing Help](#)"

Information in this document is subject to change without notice.
© 2002-2003 Dell Computer Corporation. All rights reserved.

Reproduction in any manner whatsoever without the written permission of Dell Computer Corporation is strictly forbidden.

Trademarks used in this text: *Dell*, the *DELL* logo, *Inspiron*, *Dell Precision*, *Dimension*, *OptiPlex*, and *Latitude* are trademarks of Dell Computer Corporation; *Intel*, *Celeron*, and *Pentium* are registered trademarks and *Intel SpeedStep* is a trademarks of Intel Corporation; *Microsoft*, *MS-DOS*, and *Windows* are registered trademarks of Microsoft Corporation.

Other trademarks and trade names may be used in this document to refer to either the entities claiming the marks and names or their products. Dell Computer Corporation disclaims any proprietary interest in trademarks and trade names other than its own.

February 2003 Rev. A02

[Back to Contents Page](#)

Memory Module, Modem, Optical Drive, and Floppy Drive

Dell™ Inspiron™ 2600 and 2650

- [Memory Module](#)
 - [Modem](#)
 - [Optical Drive](#)
 - [Floppy Drive](#)
-

Memory Module

Removing the Memory Module/Modem Cover

- ➔ **NOTICE:** Disconnect the computer and any attached devices from electrical outlets, and remove any installed battery.
 - ➔ **NOTICE:** To avoid ESD, ground yourself by using a wrist grounding strap or by touching an unpainted metal surface on the computer.
 - ➔ **NOTICE:** Read "[Preparing to Work Inside the Computer](#)" before performing the following procedure.
 - 🔍 **HINT:** This procedure covers removing and replacing the memory module located under the memory module/modem cover on the bottom of the computer. A second memory module resides on the upper surface of the system board under the EMI shield. To replace the memory module under the EMI shield, perform the procedure for removing the [EMI shield](#). Then replace the memory module.
1. Turn the computer over, and remove the memory module/modem cover:
 - a. Remove the M2.5 x 5-mm screw from the memory module/modem cover.
 - b. Slide the cover out approximately 10 mm, and lift it away from the computer.

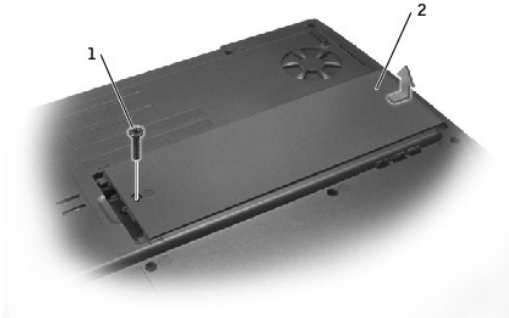

1	M2.5 x 5-mm screw
2	memory module/modem cover

- ➔ **NOTICE:** To prevent damage to the memory module connector, do not use tools to spread the inner metal tabs that secure the memory module.
2. If you are replacing a memory module, remove the existing module.
 - ➔ **NOTICE:** Handle memory modules by their edges, and do not touch the components on a module.
 - a. Use your fingertips to carefully spread apart the securing clips on each end of the memory module connector.
The module should pop up.
 - b. Remove the module from the connector.

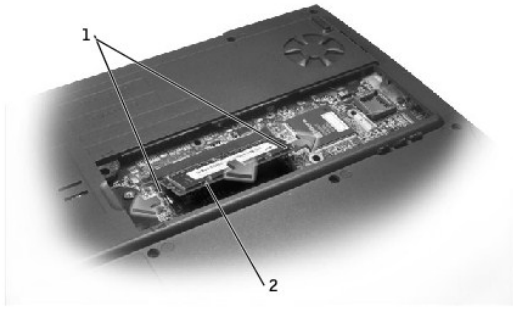

1	securing clips
2	memory module

3. Ground yourself and install the new memory module:

- a. Align the notch in the module with the slot in the center of the connector.
- b. Slide the edge of the module firmly into the connector, and rotate the module down until you hear a click. If you do not hear the click, remove the module and reinstall it.

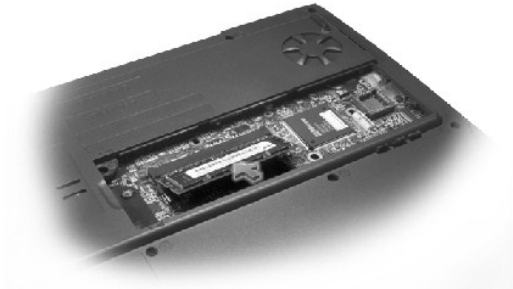

4. Replace the cover and screw:

- a. Place the memory module/modem cover over the memory module/modem compartment so that the end of the cover with the screw hole is lined up with the lines and arrows on the bottom of the computer.
- b. Press down on the center of the memory module/modem cover, and slide the cover until it is secured.
- c. Replace and tighten the M2.5 x 5-mm screw.

➡ **NOTICE:** If the memory module/modem cover is difficult to close, remove the module and reinstall it. Forcing the cover to close may damage your computer.

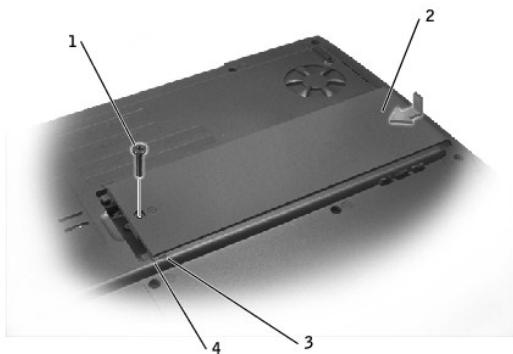

1	M2.5 x 5-mm screw
---	-------------------

2	memory module/modem cover
3	arrows (2)
4	lines (2)

5. Insert the battery into the battery bay, or connect the AC adapter to your computer and an electrical outlet.
6. Turn on the computer.

As the computer boots, it detects the additional memory and automatically updates the system configuration information.

Modem

⚠ CAUTION: Before performing these procedures, turn off the computer, disconnect it from the electrical outlet, and disconnect the modem from the telephone wall jack.

➡ NOTICE: Disconnect any attached devices from electrical outlets, and remove any installed battery.

➡ NOTICE: To avoid ESD, ground yourself by using a wrist grounding strap or by touching an unpainted metal surface on the computer.

➡ NOTICE: Read "[Preparing to Work Inside the Computer](#)" before performing the following procedure.

1. Turn the computer over, and remove the memory module/modem cover:
 - a. Remove the M2.5 x 5-mm screw from the memory module/modem cover.
 - b. Slide the cover out approximately 10 mm, and lift it away from the computer.

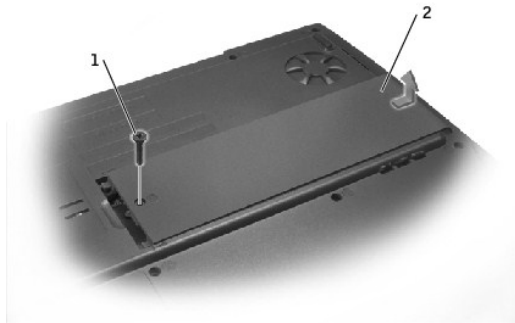

1	M2.5 x 5-mm screw
2	memory module/modem cover

2. If a modem is not already installed, go to [step 3](#). If you are replacing a modem, remove the existing modem:
 - a. Remove the two M2 x 3-mm screws that secure the modem to the system board, and set them aside.
 - b. Pull the modem straight up by the pull tab to lift the modem out of its connector, and disconnect the modem cable.

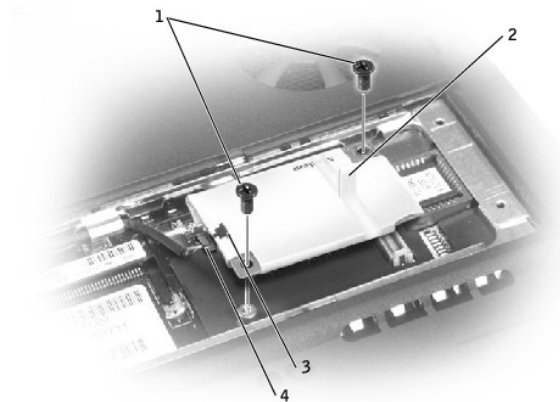

1	M2 x 3-mm screws (2)
2	pull tab
3	modem cable connector
4	modem cable

3. Connect the modem cable to the new modem.

➡ **NOTICE:** The cable connectors are keyed for correct insertion; do not force the connections.

4. Align the modem with the screw holes and press the modem into its connector on the system board.

Install the two M2 x 3-mm screws to secure the modem to the system board.

5. Replace the memory module/modem cover and screw:

- a. Place the memory module/modem cover over the memory module/modem compartment so that the end of the cover with the screw hole is lined up with the lines and arrows on the bottom of the computer.
- b. Press down on the center of the memory module/modem cover, and slide the cover until it is secured.
- c. Replace and tighten the M2.5 x 5-mm screw.

➡ **NOTICE:** Replace the memory module/modem cover so that it is seated properly around the edges and does not bulge near the center of the cover. Tightening the memory-module/modem cover screw when the cover is improperly seated can damage your computer.

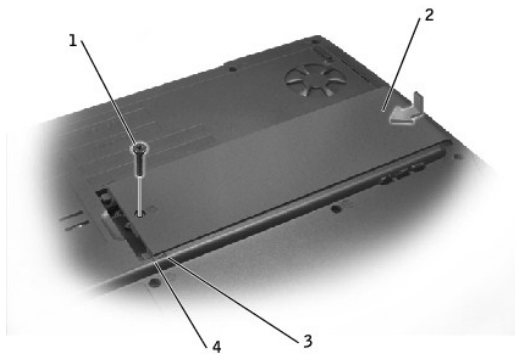

1	M2.5 x 5-mm screw
2	memory module/modem cover
3	arrows (2)
4	lines (2)

Optical Drive

Removing an Installed Optical Drive

➡ **NOTICE:** To avoid ESD, ground yourself by using a wrist grounding strap or by touching an unpainted metal surface on the computer.

➡ **NOTICE:** Read "[Preparing to Work Inside the Computer](#)" before performing the following procedure.

1. If a disc is in the optical drive, remove the disc.

➡ **NOTICE:** Disconnect the computer and attached devices from electrical outlets, and remove any installed battery.

2. Remove the memory module/modem cover:
 - a. Remove the M2.5 x 5-mm screw from the memory module/modem cover.
 - b. Slide the cover out approximately 10 mm, and lift it away from the computer.

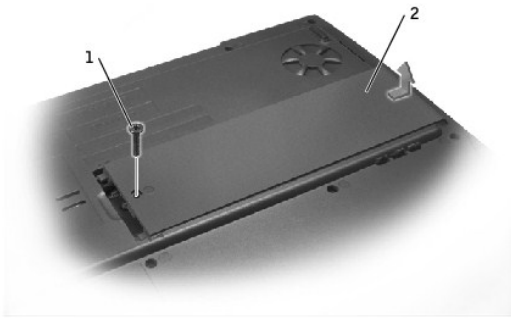

1	M2.5 x 5-mm screw
2	memory module/modem cover

3. Remove the M2.5 x 8-mm screw from the optical drive.
4. Press the optical-drive release button, and pull the optical drive out of the computer.

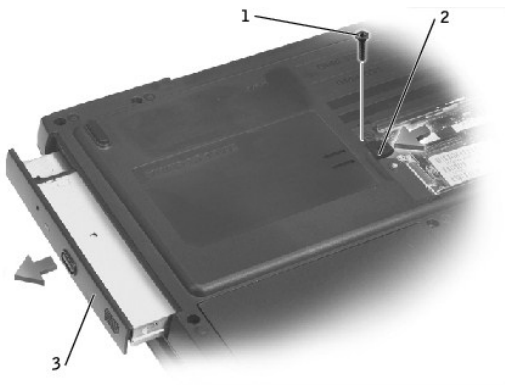

1	M2.5 x 8-mm screw
2	optical-drive release button
3	optical drive

Installing an Optical Drive

1. Slide the optical drive into the bay until the optical drive is fully seated.
2. Replace and tighten the M2.5 x 8-mm screw.

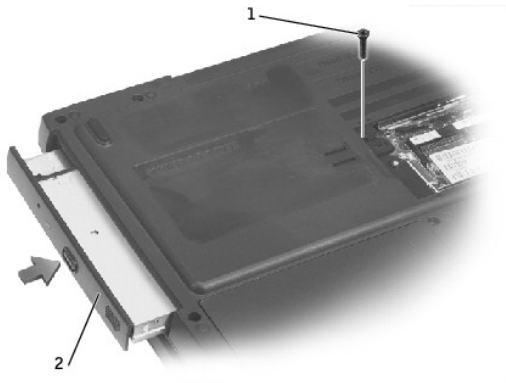

1	M2.5 x 8-mm screw
2	optical drive

⚠ **NOTICE:** Replace the memory module/modem cover so that it is seated properly around the edges and does not bulge near the center of the cover. Tightening the memory module/modem cover screw when the cover is improperly seated can damage your computer.

3. Replace the memory module/modem cover and screw:
 - a. Place the memory module/modem cover over the memory module compartment so that the end of the cover with the screw hole is lined up with the lines and arrows on the bottom of the computer.
 - b. Press down on the center of the memory module/modem cover, and slide the memory module/modem cover until it is secured.
 - c. Replace and tighten the M2.5 x 5-mm screw.

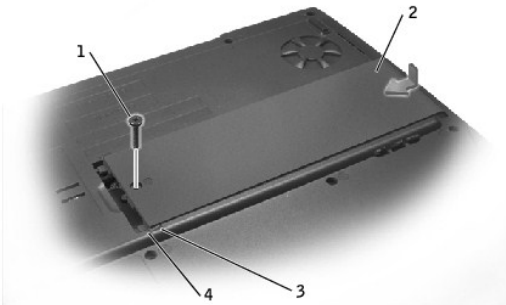

1	M2.5 x 5-mm screw
2	memory module/modem cover
3	arrows (2)
4	lines (2)

Floppy Drive

Removing an Installed Floppy Drive

- ⚠ **NOTICE:** To avoid ESD, ground yourself by using a wrist grounding strap or by touching an unpainted metal surface on the computer.
- ⚠ **NOTICE:** Read "[Preparing to Work Inside the Computer](#)" before performing the following procedure.

1. If a disk is in the floppy drive, remove the disk.

➔ **NOTICE:** Disconnect the computer and attached devices from electrical outlets, and remove any installed battery.

➔ **NOTICE:** Ensure that you disconnect the flex cable from the ZIF connector before you remove the floppy drive from the computer. See [step 3](#) for further instructions.

2. Remove the two M2.5 x 5-mm screws from the floppy drive, and partially pull the drive out of the computer.

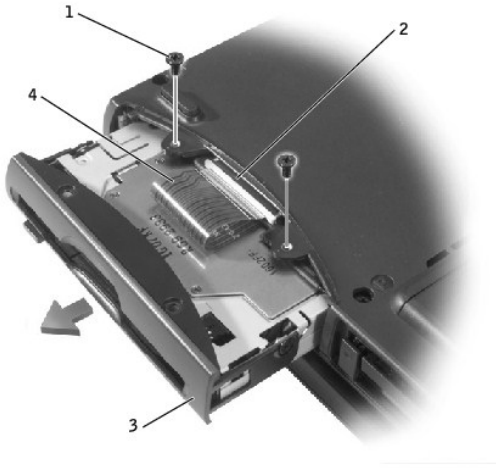

1	M2.5 x 5-mm screws (2)
2	ZIF connector
3	floppy drive
4	flex cable

➔ **NOTICE:** Release the securing tab before you disconnect the flex cable from the ZIF connector. Failure to do so can damage the ZIF connector.

3. Disconnect the flex cable from the ZIF connector:

- a. Pull the securing tab away from the ZIF connector.
- b. Gently pull the flex cable out of the ZIF connector.

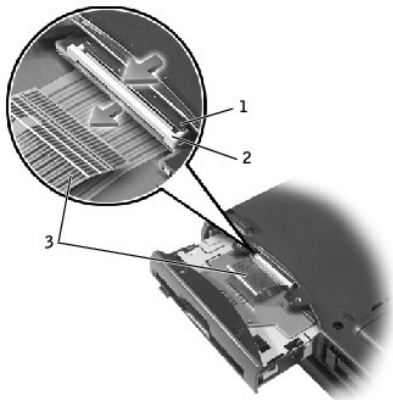

1	ZIF connector
2	securing tab

Installing a Floppy Drive

1. Slide the floppy drive partially into the bay.

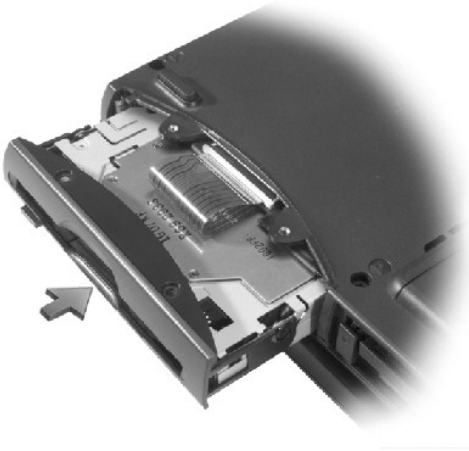

HINT: If you do not connect the flex cable to the ZIF connector properly, your floppy drive will not function properly.

2. Reconnect the flex cable to the ZIF connector:
 - a. Pull and hold the securing tab away from the ZIF connector.
 - b. While holding the securing tab, insert the flex cable into the ZIF connector.
Ensure that you insert the flex cable *into* the ZIF connector and not below the ZIF connector.
 - c. Hold the flex cable in place and push the securing tab toward the ZIF connector.

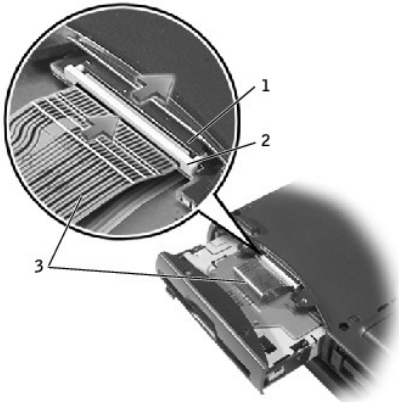

1	ZIF connector
2	securing tab
3	flex cable

3. Slide the floppy drive into the bay until the drive is fully seated.
4. Replace and tighten the two M2.5 x 5-mm screws.
5. Install the battery.
6. Turn on the computer and try using the floppy drive.

If the computer does not detect the floppy drive, you may have improperly inserted the flex cable. If so, disconnect the flex cable and reconnect it to the ZIF connector.

[Back to Contents Page](#)

Reinstalling Microsoft® Windows® Operating Systems

Dell™ Inspiron™ 2600 and 2650



- [Reinstalling Windows® XP](#)
- [Reinstalling Windows 2000](#)



Reinstalling Windows® XP

Before reinstalling the Microsoft® Windows XP operating system to correct a problem, try correcting the problem by using [System Restore](#).

➡ **NOTICE:** The *Operating System* CD provides options for reinstalling the Windows XP operating system. The options can potentially overwrite files installed by Dell and possibly affect programs installed on your hard drive. Therefore, Dell does not recommend that you reinstall your operating system unless instructed to do so by a Dell technical support representative.

🔧 **HINT:** The CD that you need to place in your CD or DVD drive is titled *Operating System*.

1. Insert the *Operating System* CD.
2. Shut down the computer (see "[Accessing Help](#)"), and then turn on the computer.
3. Press any key when the *Press any key to boot from CD* message appears on the screen.
4. When the **Windows XP Setup** screen appears, press  to select **To set up Windows now**.
5. Read the information in the **License Agreement** window, and then press  on your keyboard to agree with the license information.
6. If your computer already has Windows XP installed and you want to recover your current Windows XP data, type *r* to select the repair option, and then go to step 14.

If you want to install a new copy of Windows XP, press  to select the fresh copy option and then press  on the next screen to select the highlighted partition (recommended). Then follow the instructions on the screen.

The **Windows XP Setup** screen appears and Windows XP begins to copy files and install the device drivers. The computer automatically restarts multiple times before it requires additional input.

7. When the **Welcome to Microsoft** screen appears, click the green arrow icon at the bottom of the screen to continue. Then follow the instructions on the screen to finish the installation.
8. When the **Regional Settings** screen appears, select the settings for your locale, and then click **Next**.
9. Enter your name and organization in the **Personalize Your Software** screen, and then click **Next**.
10. *If you are reinstalling Windows XP Home Edition*, enter a name for your computer when the **Computer Name** window appears, and then click **Next**.
If you are reinstalling Windows XP Professional, enter a name for your computer and a password when the **Computer Name and Administrator Password** window appears, and then click **Next**.
11. If you have a modem installed, the **Modem Dialing Information** screen appears. Enter the requested information and click **Next**.
12. Enter the date, time, and time zone in the **Date and Time Settings** window and click **Next**.
13. If your computer has a network adapter, select the appropriate network settings. If your computer does not have a network adapter, you do not see this option.

Windows XP begins to install its components and configure the computer. The computer automatically restarts.









14. When the **Welcome to Microsoft** screen appears, click the green arrow icon at the bottom of the screen to continue. Then follow the instructions on the screen to complete the installation.
15. Remove the CD from the drive.
16. [Reinstall the appropriate drivers](#).
17. Reinstall your virus protection software.

Reinstalling Windows 2000

➡ **NOTICE:** The *Operating System* CD provides options for reinstalling the Windows 2000 operating system. The options can potentially overwrite files installed by Dell and possibly affect programs installed on your hard drive. Therefore, Dell does not recommend that you reinstall your operating system unless instructed to do so by a Dell technical support representative.

🔧 **HINT:** The CD that you need to place in your CD or DVD drive is titled *Operating System*.

1. Turn on the computer, and enter the system setup program as directed by a Dell technical support representative or as follows:
 - a. Shut down the computer.

- b. Before the computer boots into Windows, press  to enter the system setup program.
 - c. Press   to move to the **Boot** menu.
 - d. In the system setup program **Boot** menu, follow the instructions on the screen to change the boot sequence so that the CD or DVD drive boots first. Then insert the *Operating System* CD into the drive.
 - e. Press  to save your changes and exit the system setup program.
 - f. Press any key to boot the computer from the CD.
2. When the **Windows 2000 Setup** window appears, ensure that **To setup Win2000 now, press ENTER** is highlighted. Then press .
 3. Read the information in the **License Agreement** window, and then press  to continue.
 4. When the **Windows 2000 Professional Setup** window appears, press the arrow keys to select the Windows 2000 partition option that you want. Then press the key for the partition option you chose.
 5. When the **Windows 2000 Professional Setup** window reappears, press the arrow keys to select the type of file system that you want Windows 2000 to use, and then press .
 6. Press  again to restart your computer.
 7. Click **Next** when the **Welcome to the Windows 2000 Setup Wizard** window appears.
 8. When the **Regional Settings** window appears, select your region, and then click **Next**.
 9. Enter your name and organization in the **Personalize Your Software** window, and then click **Next**.
 10. Enter the Windows product key, which is printed on the Microsoft label on your computer. Then click **Next**.
 11. When the **Computer Name and Administrator Password** window appears, enter a name for your computer and a password, if desired. Then click **Next**.
 12. Enter the date and time in the **Date and Time Settings** window, and then click **Next**.
Windows 2000 installs components and configures the computer.
 13. When the **Completing the Windows 2000 Setup Wizard** window appears, remove the CD from the drive, and then click **Finish**.
The computer automatically restarts.
-

[Back to Contents Page](#)