

MAINTENANCE & SERVICE GUIDE

for Prosignia 150 Series Computer

[Index Page](#)
[Product Description](#)

[Preface -or- Notice](#)
[Illustrated Parts Catalog](#)

[Specifications](#)
[Troubleshooting](#)

[Battery Pack](#)
[Removal & Replacement](#)

Welcome to the Maintenance & Service Guide (MSG) for the **Compaq Prosignia 150.**

This is an online guide designed to serve the needs of those whose job it is to repair Compaq products.

Please first read the [Notice](#) which contains copyright and trademark information.

Then read the [Preface](#) which shows symbol conventions, technician notes and the serial number location for the unit.



Click here to [download the complete ZIP file \(2.2 MB\) of this Maintenance & Service Guide to your hard drive.](#)

This MSG will be periodically maintained and updated as needed.
To report a technical problem, contact your Regional Support Center or IM Help Center.
For content comments or questions, contact the [Editor](#).

MAINTENANCE & SERVICE GUIDE

for Prosignia 150 Series Computer

[Index Page](#)

[Preface -or- Notice](#)

[Specifications](#)

[Battery Pack](#)

[Product Description](#)

[Illustrated Parts Catalog](#)

[Troubleshooting](#)

[Removal & Replacement](#)

Preface

This Maintenance and Service Guide is a troubleshooting guide that can be used for reference when servicing the Compaq Prosignia Series Portable Computers.

Compaq Computer Corporation reserves the right to make changes to the Compaq Prosignia Series Portable Computers without notice.

Symbols

The following words and symbols mark special messages throughout this guide:

	WARNING: Text set off in this manner indicates that failure to follow directions in the warning could result in bodily harm or loss of life.
---	---

	CAUTION: Text set off in this manner indicates that failure to follow directions could result in damage to equipment or loss of data.
---	--

IMPORTANT: Text set off in this manner presents clarifying information or specific instructions.

NOTE: Text set off in this manner presents commentary, sidelights, or interesting points of information.

Technician Notes

	WARNING: Only authorized technicians trained by Compaq should repair this equipment. All troubleshooting and repair procedures are detailed to allow only subassembly/module level repair. Because of the complexity of the individual boards and subassemblies, the user should not attempt to make repairs at the component level or to make modifications to any printed circuit board. Improper repairs can create a safety hazard. Any indications of component replacement or printed circuit board modifications may void any warranty.
---	---

Serial Number

When requesting information or ordering spare parts, the computer serial number should be provided to Compaq. The serial number is located on the bottom of the computer.

Locating Additional Information

The following documentation is available to support this product:

- Compaq Prosignia Series Portable Computer documentation set
- Introducing Windows 98 Guide
- Service Training Guides
- Compaq Service Advisories and Bulletins
- Compaq QuickFind
- Compaq Service Quick Reference Guide

MAINTENANCE & SERVICE GUIDE

for Prosignia 150 Series Computer

[Index Page](#)
[Product Description](#)

[Preface -or- Notice](#)
[Illustrated Parts Catalog](#)

[Specifications](#)
[Troubleshooting](#)

[Battery Pack](#)
[Removal & Replacement](#)

Notice

The information in this guide is subject to change without notice.

COMPAQ COMPUTER CORPORATION SHALL NOT BE LIABLE FOR TECHNICAL OR EDITORIAL ERRORS OR OMISSIONS CONTAINED HEREIN, NOR FOR INCIDENTAL OR CONSEQUENTIAL DAMAGES RESULTING FROM THE FURNISHING, PERFORMANCE, OR USE OF THIS MATERIAL.

This guide contains information protected by copyright. No part of this guide may be photocopied or reproduced in any form without prior written consent from Compaq Computer Corporation.

Ó 1999 Compaq Computer Corporation.
All rights reserved. Printed in the U.S.A.

Compaq, Prosignia Series Registered U. S. Patent and Trademark Office.

Microsoft, MS-DOS, and Windows are registered trademarks of Microsoft Corporation. Windows 98 is a trademark of Microsoft Corporation.

The software described in this guide is furnished under a license agreement or nondisclosure agreement. The software may be used or copied only in accordance with the terms of the agreement.

Product names mentioned herein may be trademarks and/or registered trademarks of their respective companies.

Maintenance and Service Guide

Compaq Prosignia Series Series Portable Computer

First Edition (March 1999)
Compaq Computer Corporation

MAINTENANCE & SERVICE GUIDE

for Prosignia 150 Series Computer

[Index Page](#)
[Product Description](#)

[Preface -or- Notice](#)
[Illustrated Parts Catalog](#)

[Specifications](#)
[Troubleshooting](#)

[Battery Pack](#)
[Removal & Replacement](#)

Specifications

[Index Page](#)

This chapter covers the following specifications of Compaq Prosignia Series Portable Computers. Click on a link to go to a particular specification:

*
System Unit
System Interrupts
System DMA
System I/O
System Memory
Display
Memory Expansion
Battery Pack
Diskette Drive
Hard Drives
CD/DVD Drives
Modem
AC Adapter
Pin Assignments
*

MAINTENANCE & SERVICE GUIDE

for Prosignia 150 Series Computer

[Index Page](#)
[Product Description](#)

[Preface -or- Notice](#)
[Illustrated Parts Catalog](#)

[Specifications](#)
[Troubleshooting](#)

[Battery Pack](#)
[Removal & Replacement](#)

Increasing Battery Pack Operating Time

Battery pack operating time differs depending on several variables. To avoid unnecessary replacement, consider the following variables when determining how long a charged battery pack should last:

- Power management settings
- Hardware configuration
- Software applications
- Installed options
- Display brightness
- Hard drive usage
- Changes in operating temperature
- Type and number of installed PC Cards

NOTE: The power consumption requirements for PC Cards vary widely. Some cards drain the battery pack very rapidly.

Battery pack operating time can be increased by as much as 50 percent by controlling the energy required by the computer and the energy stored in the battery pack.

Minimizing the Energy Required

To minimize the energy required by the computer, follow these steps:

- Set the power conservation levels in the Power Management utility to Maximum.
- Customize the timeout value to work more efficiently with the applications. The amount of battery life depends on the values selected.

Maximizing the Energy Stored

To maximize the energy stored in the battery pack, follow these guidelines:

- Condition the battery pack at least every 30 days to improve overall battery performance.
- Keep a battery pack in the computer when using it with AC power to supply the battery pack with a constant trickle charge.
- Store the battery pack in a cool, dry place when not in use.

Conditioning a Battery Pack



CAUTION: To avoid a loss of data, ensure that all data is saved before discharging a battery pack.

To condition a battery pack, complete the following steps:

1. Plug in the AC adapter and allow the battery to charge until the LED light on the display stops blinking. Your battery gauge may read 100 percent for a period of time before LED light on the display stops blinking. Do not unplug the AC adapter until the arrow disappears.
2. Unplug the AC adapter and allow the battery to drain until the computer reaches hibernation and turns itself off. Do not plug in the AC adapter during this process or you will need to restart with Step No. 1. You may use the computer while the battery is draining.
3. Your battery is re- conditioned.
4. Plug in the AC adapter and begin using the computer.

The table below shows the approximate battery pack charge times:

Approximate Battery Charge Time		
Computer	On Line	Off Line
NiMH Battery Pack	4.0 hours premature termination	2:00 hrs
Li ion Battery Pack	4.5 hours premature termination	2:50 hrs

Disposal of a Used Battery Pack

In the interest of safeguarding our environment, Compaq Computer Corporation recommends that nickel metal hydride (NiMH) and lithium ion (Li ion) battery packs be recycled. Battery packs should be handled in accordance with country, state, province, or local regulations.



CAUTION: Never attempt to open or service a battery pack. Opening a battery pack not only damages the pack and makes it unusable, but also expose potentially harmful battery components.

MAINTENANCE & SERVICE GUIDE

for Prosignia 150 Series Computer

[Index Page](#)
[Product Description](#)

[Preface -or- Notice](#)
[Illustrated Parts Catalog](#)

[Specifications](#)
[Troubleshooting](#)

[Battery Pack](#)
[Removal & Replacement](#)

Product Description

Index Page

*
Models
Features & Controls
Front Bezel Buttons
Front Bezel Lights
Left Side Components
Right side Components
Bottom of Unit
Rear Connectors
Power Managing
*



MAINTENANCE & SERVICE GUIDE

for Prosignia 150 Series Computer

[Index Page](#)
[Product Description](#)

[Preface -or- Notice](#)
[Illustrated Parts Catalog](#)

[Specifications](#)
[Troubleshooting](#)

[Battery Pack](#)
[Removal & Replacement](#)

Illustrated Parts Catalog

Index Page

This section helps identify the number associated with each item(s) for the Compaq Prosignia Series Portable Computers. These Numbers are used to order replacement parts.

System Unit
Mass Storage Devices
Board Components
Cable Kit
Hardware Kit
Plastics Kit
Display Assembly
Miscellaneous Parts
Documentation & Software

MAINTENANCE & SERVICE GUIDE

for Prosignia 150 Series Computer

[Index Page](#)
[Product Description](#)

[Preface -or- Notice](#)
[Illustrated Parts Catalog](#)

[Specifications](#)
[Troubleshooting](#)

[Battery Pack](#)
[Removal & Replacement](#)

Troubleshooting

Index Page

*
> Preliminaries
> Clearing CMOS
> Power-on Self-test
> Compaq Diagnostics
> Diagnostic Error codes
> Test Utilities
> Solving Minor Problems
> Contacting Compaq
*

This section covers troubleshooting information for the Compaq Prosignia Series Portable Computers. The basic steps in troubleshooting include:

1. Follow the [Preliminary Steps](#).
2. Run the [Power-On Self-Test](#) (POST).
3. Follow the recommended actions described in the diagnostic tables, if you are unable to run POST or if POST displays an error message.

When following the recommended actions in the Sections on POST and [Diagnostic Error Codes](#) perform them in the order listed. Rerun POST after each recommended action until the problem is solved and no error message occurs. Once the problem is solved, do not complete the remaining recommended actions.

NOTE: If the problem is intermittent, check the computer several times to verify that the problem is solved.

MAINTENANCE & SERVICE GUIDE

for Prosignia 150 Series Computer

[Index Page](#)
[Product Description](#)

[Preface -or- Notice](#)
[Illustrated Parts Catalog](#)

[Specifications](#)
[Troubleshooting](#)

[Battery Pack](#)
[Removal & Replacement](#)

Removal & Replacement

Serial Number Location

This section explains the removal and replacement procedures for the computer.

*
> Preliminaries
> Serial Number Location
> Battery Pack
> Touchpad Assembly
> Keyboard
> Heatspreader
> Processor
> Hard Drive
> CD/DVD Drive
> Battery Charger Board
> Modem
> Display
> CPU cover
> Speakers
> Diskette Drive
> Fan Assembly
> System Board
> Dipswitch Settings
> Memory Module
*

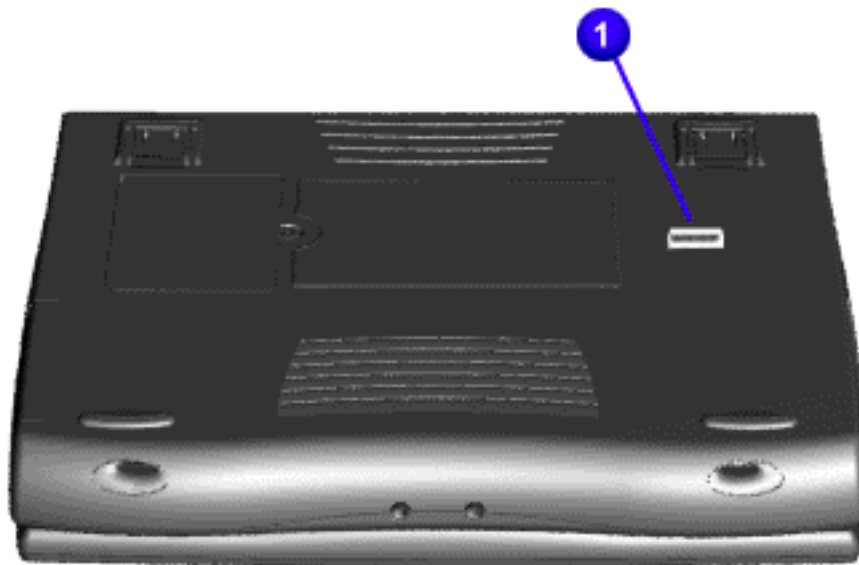

Report the computer serial number **1** to Compaq when requesting information or ordering spare parts.

MAINTENANCE & SERVICE GUIDE

for Prosignia 150 Series Computer

[Index Page](#)
[Product Description](#)

[Preface -or- Notice](#)
[Illustrated Parts Catalog](#)

[Specifications](#)
[Troubleshooting](#)

[Battery Pack](#)
[Removal & Replacement](#)

Removal & Replacement

Preliminaries

The following links are preliminary instructions which should be read before continuing with the Removal & Replacement section of this Guide. Please read the following pages before servicing your computer:

[Electrostatic Discharge](#)

[Service Considerations](#)

[Cables & Connectors](#)

[Preparing Computer for Disassembly](#)

MAINTENANCE & SERVICE GUIDE

for Prosignia 150 Series Computer

[Index Page](#)
[Product Description](#)

[Preface -or- Notice](#)
[Illustrated Parts Catalog](#)

[Specifications](#)
[Troubleshooting](#)

[Battery Pack](#)
[Removal & Replacement](#)

Electrostatic Discharge

A sudden discharge of static electricity from a finger or other conductor can destroy static-sensitive devices or microcircuitry. Often the spark is neither felt nor heard, but damage occurs. An electronic device exposed to electrostatic discharge (ESD) may not be affected at all and will work perfectly throughout a normal cycle. Although, it may function normally for a while, then degrade in the internal layers, reducing its life expectancy.

Networks built into many integrated circuits provide some protection, but in many cases, the discharge contains enough power to alter device parameters or melt silicon junctions.

Generating Static

The table shows how different activities generate static electricity and at different electrostatic voltage levels.

Typical Electrostatic Voltages			
Event	Relative Humidity		
	10%	40%	55%
Walking across carpet	35,000 V	15,000 V	7,500 V
Walking across vinyl floor	12,000 V	5,000 V	3,000 V
Motions of bench worker	6,000 V	800 V	400 V
Removing DIPS from plastic tubes	2,000 V	700 V	400 V
Removing DIPS from vinyl trays	11,500 V	4,000 V	2,000 V
Removing DIPS from Styrofoam	14,500 V	5,000 V	3,500 V
Removing bubble pack from PCBs	26,000 V	20,000 V	7,000 V
Packing PCBs in foam-lined box	21,000 V	11,000 V	5,000 V

NOTE: 700 volts can degrade a product.

Continue Preliminary pages:

[Service Considerations](#)

[Cables & Connectors](#)

[Preparing Computer for Disassembly](#)

MAINTENANCE & SERVICE GUIDE

for Prosignia 150 Series Computer

[Index Page](#)
[Product Description](#)

[Preface -or- Notice](#)
[Illustrated Parts Catalog](#)

[Specifications](#)
[Troubleshooting](#)

[Battery Pack](#)
[Removal & Replacement](#)

Removal & Replacement

Service Considerations

Listed below are some of the considerations that you should keep in mind during the disassembly and assembly of the computer:

Tool and Software Requirements

To service the computer, you need the following:

- Compaq screwdriver kit (Spare Part No. 161946-001)
- Torx T-9 screwdriver
- 3/16-inch and 5mm nut drivers (for screwlocks and standoffs)
- Small, standard screwdriver
- Small, Phillips screwdriver
- Diagnostics software

Screws

The screws used in the computer are not interchangeable. If an incorrect screw is used during the reassembly process, it can damage the unit. Compaq strongly recommends that all screws removed during disassembly be kept with the part that was removed, then returned to their proper locations.

IMPORTANT: As each subassembly is removed from the computer, it should be placed away from the work area to prevent damage.

Continue Preliminary pages:

[Cables & Connectors](#)

[Preparing Computer for Disassembly](#)

MAINTENANCE & SERVICE GUIDE

for Prosignia 150 Series Computer

[Index Page](#)
[Product Description](#)

[Preface -or- Notice](#)
[Illustrated Parts Catalog](#)

[Specifications](#)
[Troubleshooting](#)

[Battery Pack](#)
[Removal & Replacement](#)

Removal & Replacement

Cables & Connectors

Most cables used throughout the unit are ribbon cables. Cables must be handled with extreme care to avoid damage. Apply only the tension required to seat or unseat the cables during insertion or removal from the connector. Handle cables by the connector whenever possible. In all cases, avoid bending, twisting, or tearing the cables, and ensure that the cables are routed in such a way that they cannot be caught or snagged by parts being removed or replaced.

Cables

Use the following precautions when handling cables to avoid damage to the cable or computer:

- Always handle cables by their connectors.
- Avoid bending, twisting, or pulling on the cables.
- Apply minimum required force when seating or unseating the cables from their connectors.
- Place the cables in such a manner that they cannot be caught or snagged by parts being removed or replaced.
- Handle flex cables with extreme care; they can tear easily.



CAUTION: When servicing these computers, ensure that cables are placed in their proper location during the reassembly process. Improper cable placement can cause severe damage to the unit.

Select the desired illustration:

Removing a Cable from a [ZIF Connector](#).

The ribbon cable position for the [4.3-GB and 6.4-GB hard drive](#).

The ribbon cable position for the [CD or DVD drive](#).

The ribbon cable position for the [diskette drive](#).

The cable position for the [speaker assembly](#).

Plastic Parts

Plastic parts can be damaged by the use of excessive force during disassembly and reassembly. When handling the plastic parts, use care. Apply pressure only at the points designated in the maintenance instructions.

Continue with last Preliminary page:

[Preparing Computer for Disassembly](#)

MAINTENANCE & SERVICE GUIDE

for Prosignia 150 Series Computer

[Index Page](#)
[Product Description](#)

[Preface -or- Notice](#)
[Illustrated Parts Catalog](#)

[Specifications](#)
[Troubleshooting](#)

[Battery Pack](#)
[Removal & Replacement](#)

Removal & Replacement

ZIF Connector

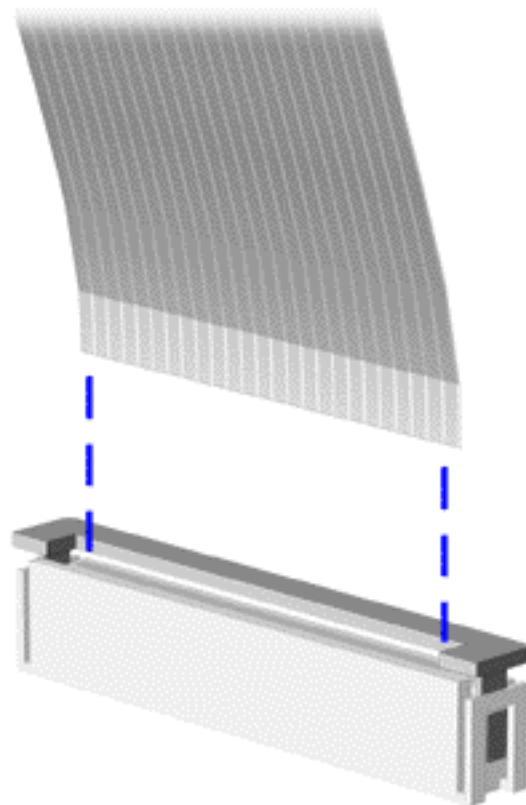

The computer uses a zero insertion force (ZIF) connector for the keyboard cable to the system board. To remove a cable from a ZIF connector, lift both corners of the ZIF connector and slide simultaneously with constant light force.



CAUTION: A ZIF connector and its attached cable can be easily damaged. Handle only the connector slide when removing or replacing a cable. Never pull or twist on the cable while it is connected.



CAUTION: When servicing this computer, ensure that cables are placed in their proper location during the reassembly process. Improper cable placement can damage the computer.

Back to [Cables and Connectors](#).

MAINTENANCE & SERVICE GUIDE

for Prosignia 150 Series Computer

[Index Page](#)
[Product Description](#)

[Preface -or- Notice](#)
[Illustrated Parts Catalog](#)

[Specifications](#)
[Troubleshooting](#)

[Battery Pack](#)
[Removal & Replacement](#)

Removal & Replacement Cable Position for the 4.3 or 6.4 GB Drives

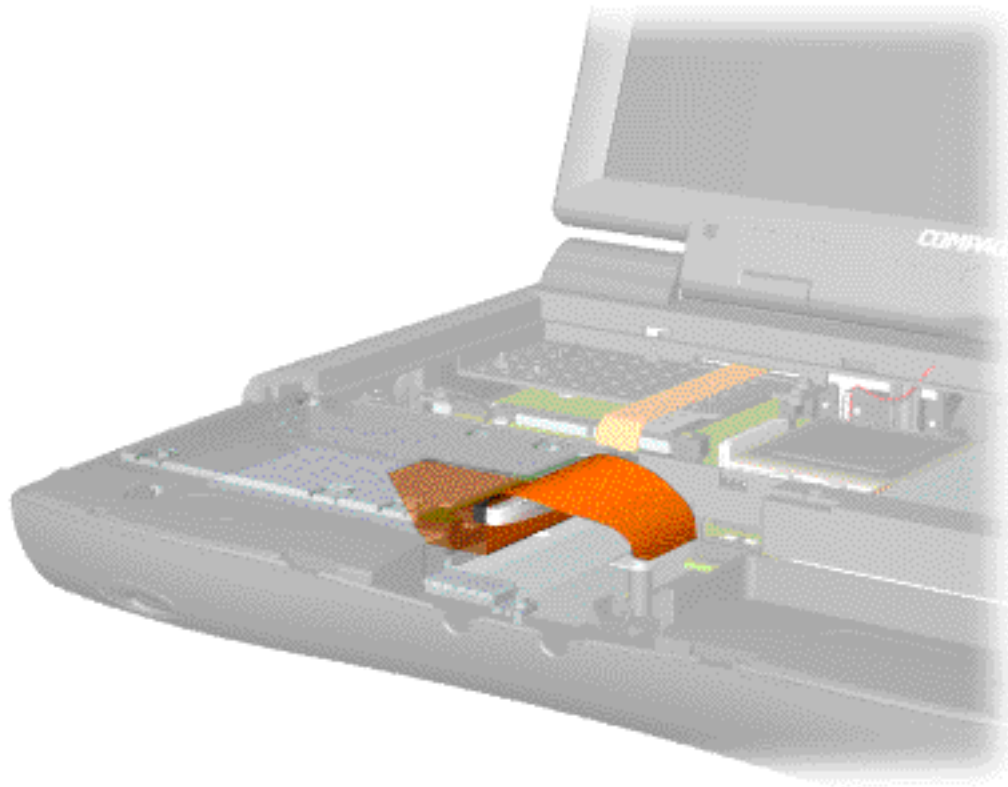

Back to [Cables and Connectors](#).

MAINTENANCE & SERVICE GUIDE

for Prosignia 150 Series Computer

[Index Page](#)
[Product Description](#)

[Preface -or- Notice](#)
[Illustrated Parts Catalog](#)

[Specifications](#)
[Troubleshooting](#)

[Battery Pack](#)
[Removal & Replacement](#)

Removal & Replacement Cable Position for the CD or DVD Drive

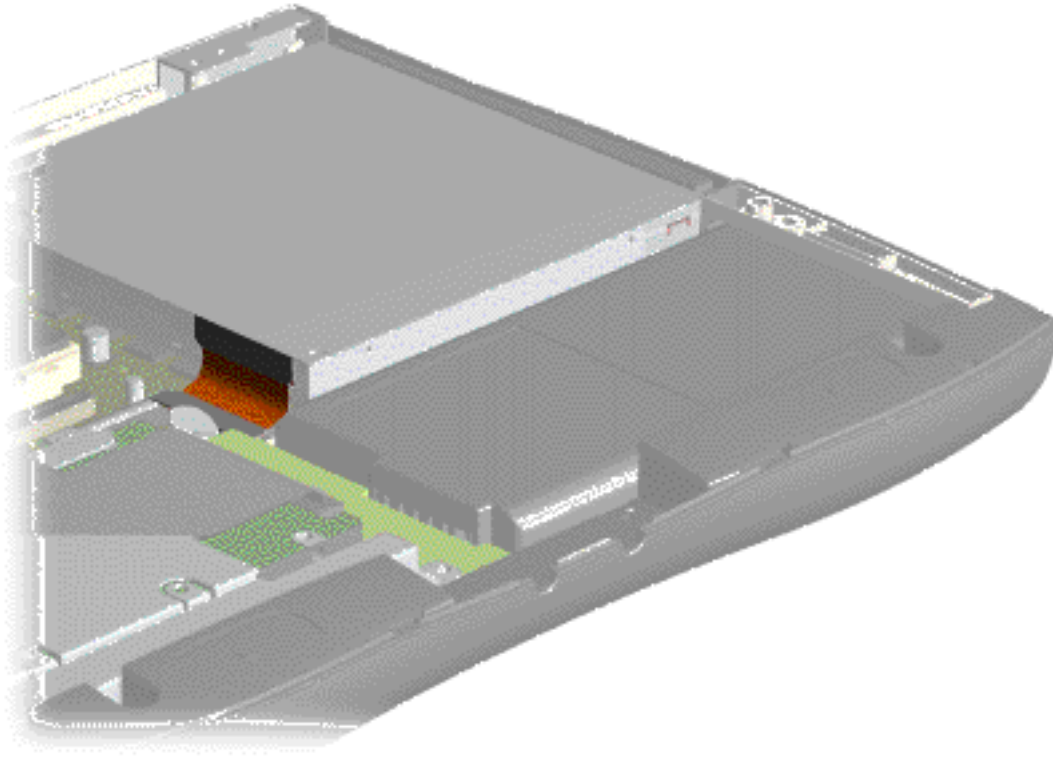

Back to [Cables and Connectors](#).

MAINTENANCE & SERVICE GUIDE

for Prosignia 150 Series Computer

[Index Page](#)
[Product Description](#)

[Preface -or- Notice](#)
[Illustrated Parts Catalog](#)

[Specifications](#)
[Troubleshooting](#)

[Battery Pack](#)
[Removal & Replacement](#)

Removal & Replacement Cable Position for the Diskette Drive

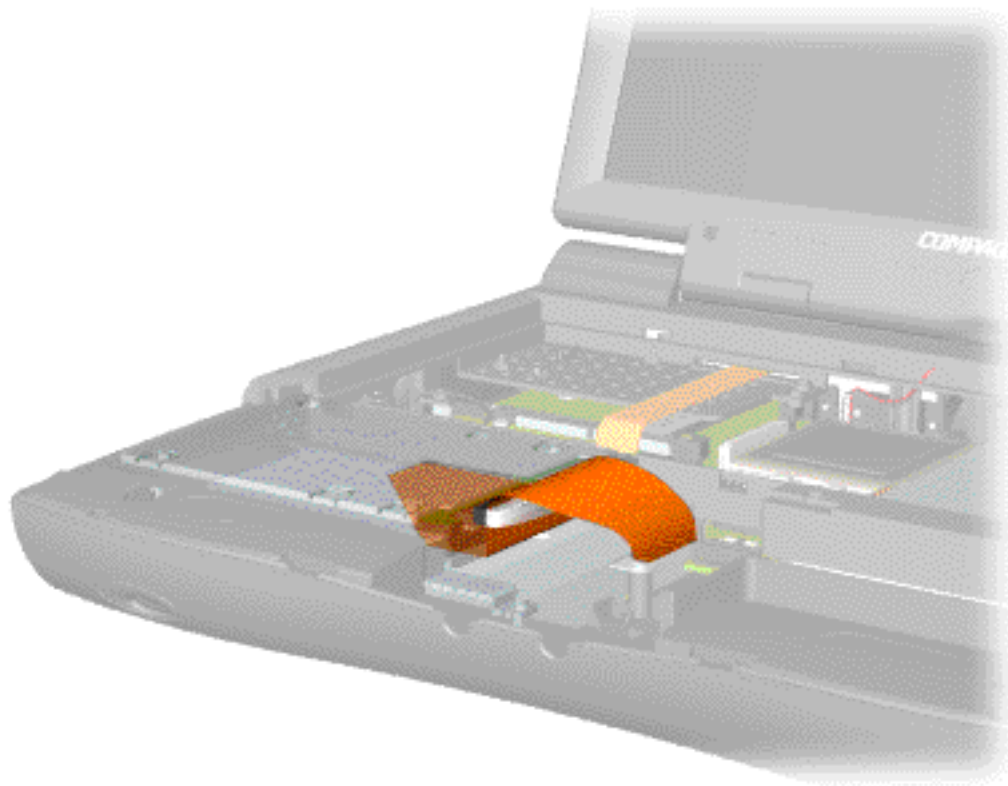

Back to [Cables and Connectors](#).

MAINTENANCE & SERVICE GUIDE

for Prosignia 150 Series Computer

[Index Page](#)
[Product Description](#)

[Preface -or- Notice](#)
[Illustrated Parts Catalog](#)

[Specifications](#)
[Troubleshooting](#)

[Battery Pack](#)
[Removal & Replacement](#)

Removal & Replacement Cable Position for the Speaker Assembly

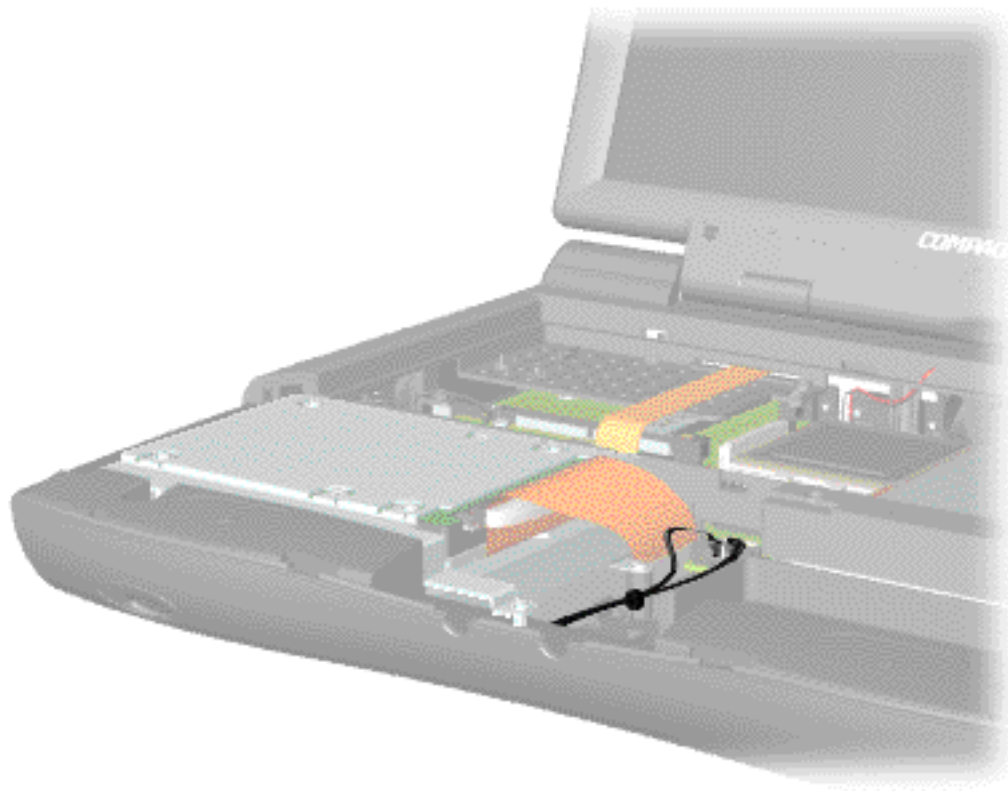

Back to [Cables and Connectors](#).

MAINTENANCE & SERVICE GUIDE

for Prosignia 150 Series Computer

[Index Page](#)
[Product Description](#)

[Preface -or- Notice](#)
[Illustrated Parts Catalog](#)

[Specifications](#)
[Troubleshooting](#)

[Battery Pack](#)
[Removal & Replacement](#)

Removal & Replacement

Preparing the computer for Disassembly

Before beginning removal and replacement procedures, complete the following procedures:

1. Disconnect AC power and any external devices.
2. Remove the battery pack.
3. Remove any PC Cards.

IMPORTANT: The battery pack should be removed before performing any internal maintenance on the computer.



WARNING: Metal objects can damage the battery pack as well as the battery contacts in the battery compartment. To prevent damage, do not allow metal objects to touch the battery contacts. Place only the battery pack for the Compaq Prosignia Series Portable Computers into the battery compartment. Do not force the battery pack into the bay if insertion does not occur easily.



CAUTION: Do not crush, puncture, or incinerate the battery pack. Do not open a battery pack, as this damages the pack, makes it unusable, and exposes potentially harmful battery components. There are no field-serviceable parts located inside the battery pack.

The Compaq Prosignia Series Portable Computers have several screws of various sizes which are not interchangeable. Care must be taken during
NOTE: reassembly to ensure that the correct screws are used in their correct location. During removal please keep respective screws with their associated sub-assembly.

Go to [Removal & Replacement Procedures](#).

MAINTENANCE & SERVICE GUIDE

for Prosignia 150 Series Computer

[Index Page](#)
[Product Description](#)

[Preface -or- Notice](#)
[Illustrated Parts Catalog](#)

[Specifications](#)
[Troubleshooting](#)

[Battery Pack](#)
[Removal & Replacement](#)

Removal & Replacement

Removing the Battery Pack

*
> Preliminaries
> Serial Number Location
> Battery Pack
> Touchpad Assembly
> Keyboard
> Heatspreader
> Processor
> Hard Drive
> CD/DVD Drive
> Battery Charger Board
> Modem
> Display
> CPU cover
> Speakers
> Diskette Drive
> Fan Assembly
> System Board
> Dipswitch Settings
> Memory Module
*



To remove the battery pack, complete the following steps:

1. Slide the battery pack compartment door down and remove it from the battery pack.

[Next Step](#)

MAINTENANCE & SERVICE GUIDE

for Prosignia 150 Series Computer

[Index Page](#)
[Product Description](#)

[Preface -or- Notice](#)
[Illustrated Parts Catalog](#)

[Specifications](#)
[Troubleshooting](#)

[Battery Pack](#)
[Removal & Replacement](#)

Removal & Replacement Touchpad Assembly

*
> Preliminaries
> Serial Number Location
> Battery Pack
> Touchpad Assembly
> Keyboard
> Heatspreader
> Processor
> Hard Drive
> CD/DVD Drive
> Battery Charger Board
> Modem
> Display
> CPU cover
> Speakers
> Diskette Drive
> Fan Assembly
> System Board
> Dipswitch Settings
> Memory Module
*

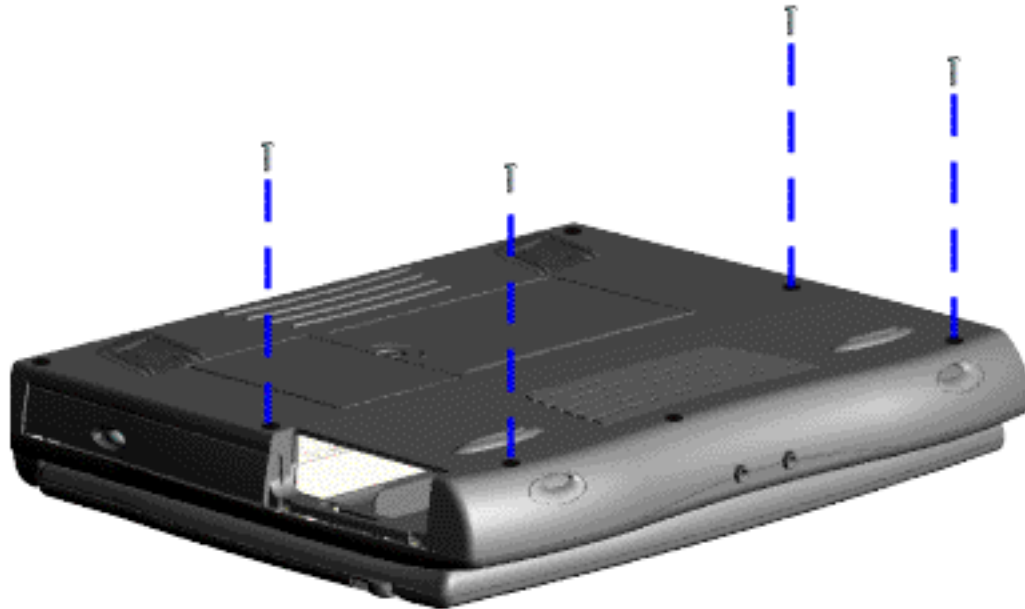

The palmrest cover with touch pad must be removed to gain access to any of the interior components of the computer, and it is the first component that has to be removed to gain access to the interior components.

It is not necessary to remove the display panel

NOTE: assembly to access the interior components of the computer.

To remove the palmrest cover with touch pad, complete the following steps:

1. [Prepare the computer for disassembly.](#)
2. Close the computer and turn the computer upside down.
3. Remove four screws from the bottom of the computer.

[Next Step](#)

MAINTENANCE & SERVICE GUIDE

for Prosignia 150 Series Computer

[Index Page](#)
[Product Description](#)

[Preface -or- Notice](#)
[Illustrated Parts Catalog](#)

[Specifications](#)
[Troubleshooting](#)

[Battery Pack](#)
[Removal & Replacement](#)

Removal & Replacement Keyboard

*
> Preliminaries
> Serial Number Location
> Battery Pack
> Touchpad Assembly
> Keyboard
> Heatspreader
> Processor
> Hard Drive
> CD/DVD Drive
> Battery Charger Board
> Modem
> Display
> CPU cover
> Speakers
> Diskette Drive
> Fan Assembly
> System Board
> Dipswitch Settings
> Memory Module
*

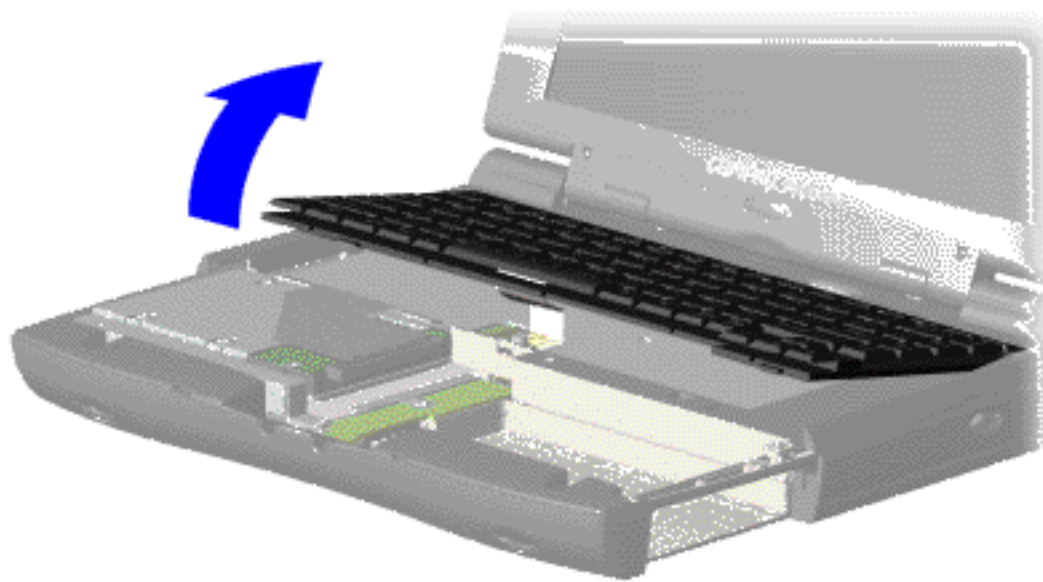

To remove the keyboard, complete the following steps:

1. [Prepare the computer for disassembly.](#)

2. [Remove the palmrest cover with touch pad.](#)

3. Gently lift and turn the keyboard over allowing it to rest on top of the palmrest cover with touchpad slot opening.

4. Remove the [heatspreader.](#)

[Next Step](#)

MAINTENANCE & SERVICE GUIDE

for Prosignia 150 Series Computer

[Index Page](#)
[Product Description](#)

[Preface -or- Notice](#)
[Illustrated Parts Catalog](#)

[Specifications](#)
[Troubleshooting](#)

[Battery Pack](#)
[Removal & Replacement](#)

Removal & Replacement Heatspreader

*
> Preliminaries
> Serial Number Location
> Battery Pack
> Touchpad Assembly
> Keyboard
> Heatspreader
> Processor
> Hard Drive
> CD/DVD Drive
> Battery Charger Board
> Modem
> Display
> CPU cover
> Speakers
> Diskette Drive
> Fan Assembly
> System Board
> Dipswitch Settings
> Memory Module
*

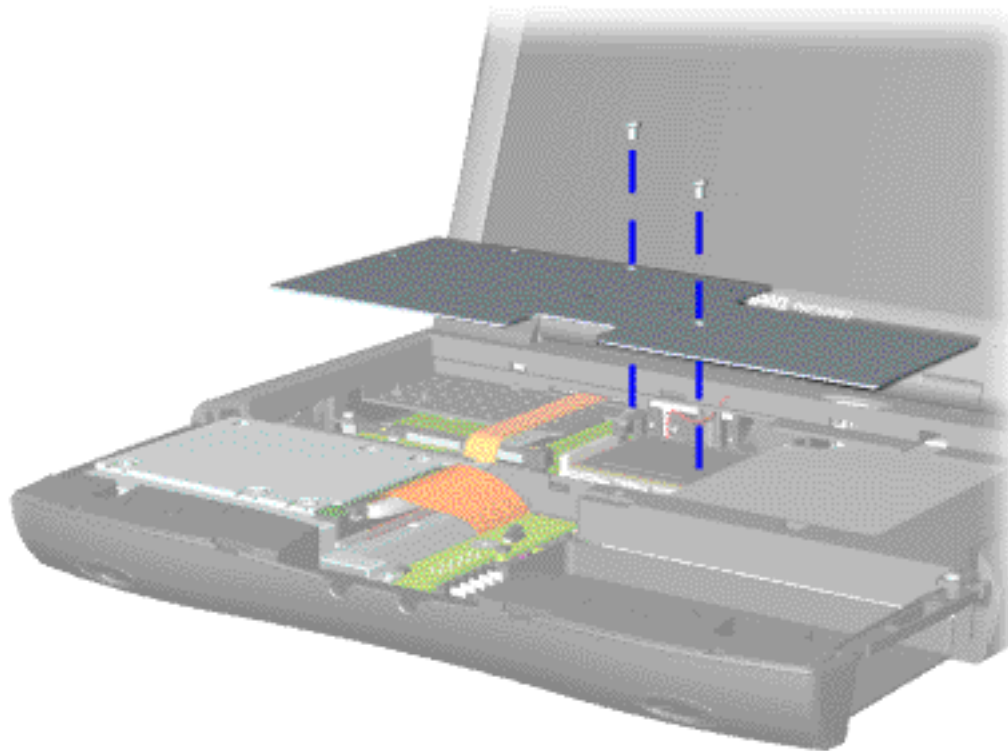

To remove the heatspreader, complete the following steps:

1. [Prepare the computer for disassembly.](#)

2. Remove the [palmrest cover with touch pad.](#)

3. Gently lift and turn the keyboard over allowing it to rest on top of the palmrest cover with touchpad slot opening.

4. Remove two screws from the heatspreader and lift out of the chassis.

To replace the heatspreader, reverse the previous procedures.

MAINTENANCE & SERVICE GUIDE

for Prosignia 150 Series Computer

[Index Page](#)
[Product Description](#)

[Preface -or- Notice](#)
[Illustrated Parts Catalog](#)

[Specifications](#)
[Troubleshooting](#)

[Battery Pack](#)
[Removal & Replacement](#)

Removal & Replacement Processor

*
> Preliminaries
> Serial Number Location
> Battery Pack
> Touchpad Assembly
> Keyboard
> Heatspreader
> Processor
> Hard Drive
> CD/DVD Drive
> Battery Charger Board
> Modem
> Display
> CPU cover
> Speakers
> Diskette Drive
> Fan Assembly
> System Board
> Dipswitch Settings
> Memory Module
*

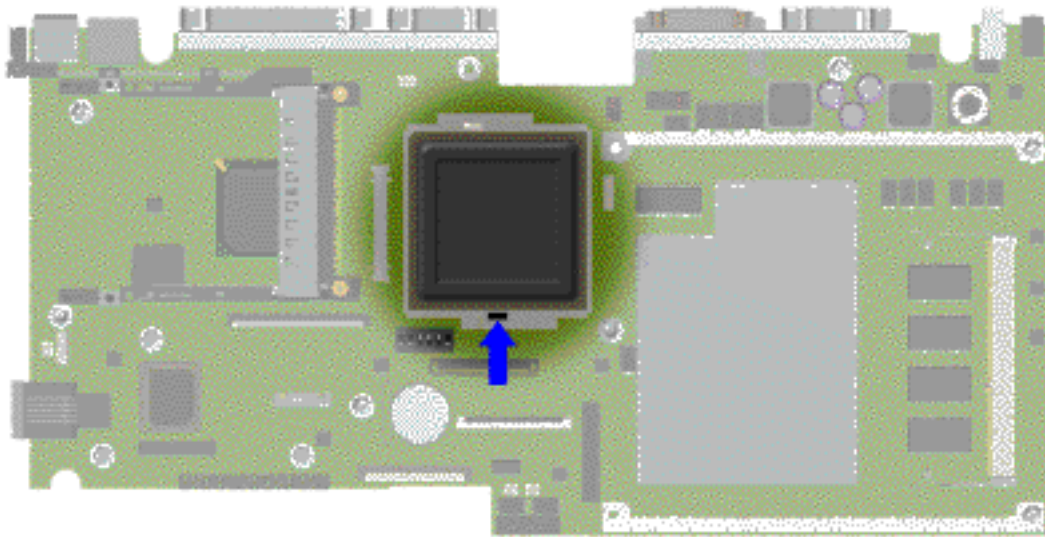

To remove the processor, complete the following steps:

1. [Prepare the computer for disassembly.](#)

2. Remove the [palmrest cover with touch pad.](#)

3. Remove the [keyboard.](#)

4. Remove the [heatspreader.](#)

5. Insert a small blade screw driver into the bottom slot opening on the processor and push toward the display to release the processor from the chassis slot.

6. Lift the processor out of the processor chassis slot.

[Next Step](#)

MAINTENANCE & SERVICE GUIDE

for Prosignia 150 Series Computer

[Index Page](#)
[Product Description](#)

[Preface -or- Notice](#)
[Illustrated Parts Catalog](#)

[Specifications](#)
[Troubleshooting](#)

[Battery Pack](#)
[Removal & Replacement](#)

Removal & Replacement 4.3 GB or 6.4 GB Hard Drive

*
> Preliminaries
> Serial Number Location
> Battery Pack
> Touchpad Assembly
> Keyboard
> Heatspreader
> Processor
> Hard Drive
> CD/DVD Drive
> Battery Charger Board
> Modem
> Display
> CPU cover
> Speakers
> Diskette Drive
> Fan Assembly
> System Board
> Dipswitch Settings
> Memory Module
*

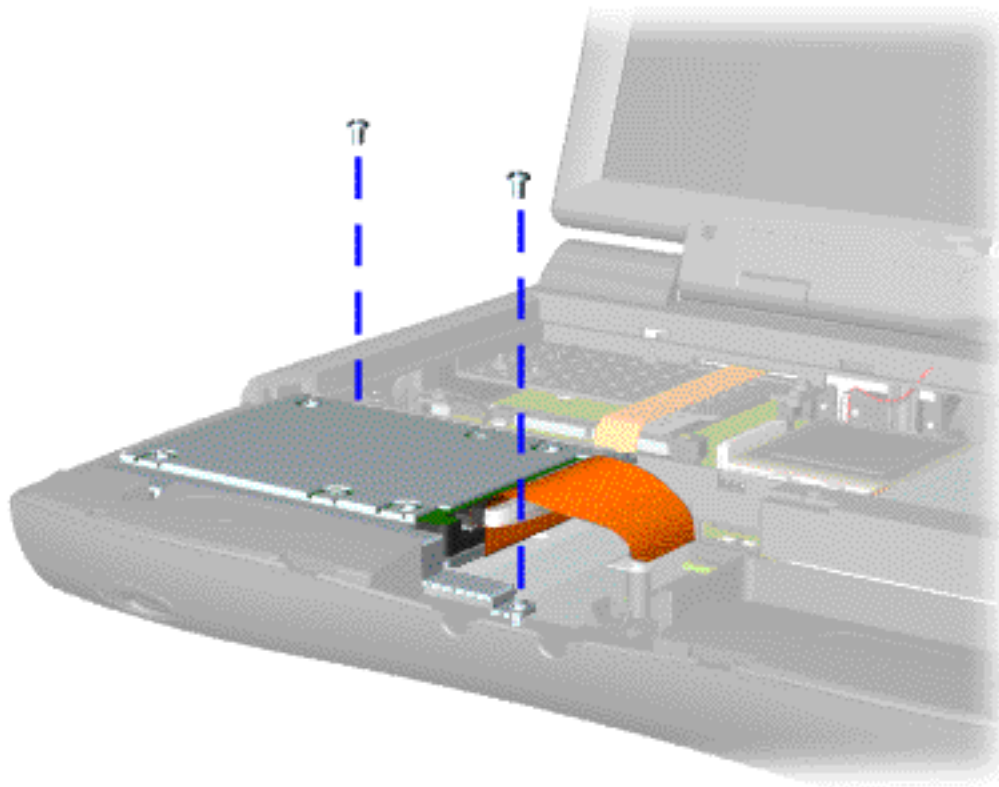

To remove the hard drive, complete the following steps:

1. Prepare the [computer for disassembly](#).
2. Remove the [palmrest cover with touch pad](#).
3. Remove the [keyboard](#).
4. Remove two screws from the hard drive mounting bracket and lift out the hard drive with drive mounting bracket attached.

[Next Step](#)

MAINTENANCE & SERVICE GUIDE

for Prosignia 150 Series Computer

[Index Page](#)
[Product Description](#)

[Preface -or- Notice](#)
[Illustrated Parts Catalog](#)

[Specifications](#)
[Troubleshooting](#)

[Battery Pack](#)
[Removal & Replacement](#)

Removal & Replacement CD or DVD Drive

*
> Preliminaries
> Serial Number Location
> Battery Pack
> Touchpad Assembly
> Keyboard
> Heatspreader
> Processor
> Hard Drive
> CD/DVD Drive
> Battery Charger Board
> Modem
> Display
> CPU cover
> Speakers
> Diskette Drive
> Fan Assembly
> System Board
> Dipswitch Settings
> Memory Module
*

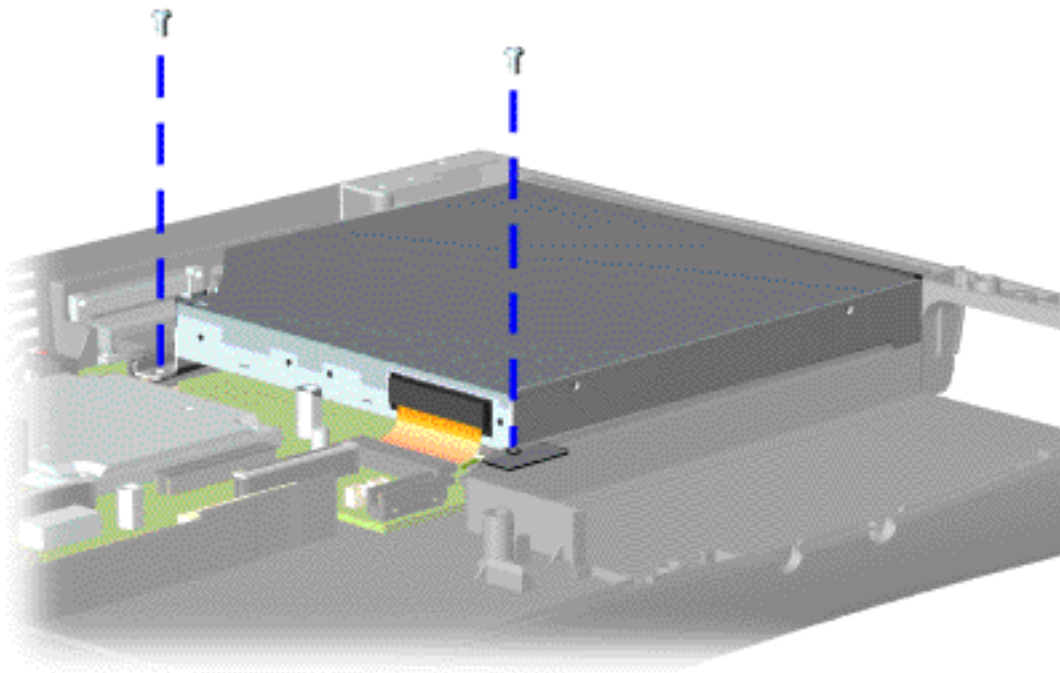

To remove the DVD or CD drive, complete the following steps:

1. Prepare the [computer for disassembly](#).
2. Remove the [palmrest cover with touch pad](#).
3. Remove the [keyboard](#).
4. Remove the [heatspreader](#).
5. Remove two screws located at the back DVD or CD drive.

[Next Step](#)

MAINTENANCE & SERVICE GUIDE

for Prosignia 150 Series Computer

[Index Page](#)
[Product Description](#)

[Preface -or- Notice](#)
[Illustrated Parts Catalog](#)

[Specifications](#)
[Troubleshooting](#)

[Battery Pack](#)
[Removal & Replacement](#)

Removal & Replacement

Battery Charger Board

*
> Preliminaries
> Serial Number Location
> Battery Pack
> Touchpad Assembly
> Keyboard
> Heatspreader
> Processor
> Hard Drive
> CD/DVD Drive
> Battery Charger Board
> Modem
> Display
> CPU cover
> Speakers
> Diskette Drive
> Fan Assembly
> System Board
> Dipswitch Settings
> Memory Module
*

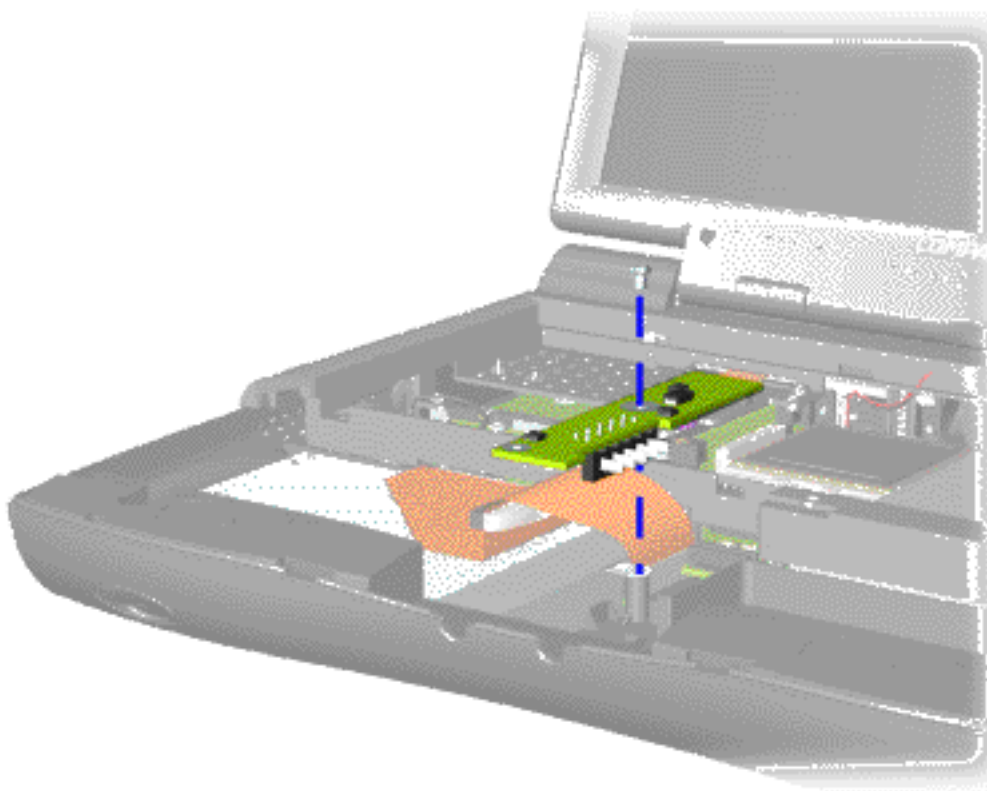

To remove the battery charger board, complete the following steps:

1. Prepare the [computer for disassembly](#).
2. Remove the [palmrest cover with touch pad](#).
3. Remove the [keyboard](#).
4. Remove the [heatspreader](#).
5. Remove the [hard drive](#).
6. Remove one screw from the battery charger board, unplug the board from the connector on the system board, and lift out of the chassis.

When replacing the battery charger board, ensure

NOTE: the pins are aligned with the connector on the system board.

To replace the battery charger board, reverse the previous procedures.

MAINTENANCE & SERVICE GUIDE

for Prosignia 150 Series Computer

[Index Page](#)
[Product Description](#)

[Preface -or- Notice](#)
[Illustrated Parts Catalog](#)

[Specifications](#)
[Troubleshooting](#)

[Battery Pack](#)
[Removal & Replacement](#)

Removal & Replacement Modem

*
> Preliminaries
> Serial Number Location
> Battery Pack
> Touchpad Assembly
> Keyboard
> Heatspreader
> Processor
> Hard Drive
> CD/DVD Drive
> Battery Charger Board
> Modem
> Display
> CPU cover
> Speakers
> Diskette Drive
> Fan Assembly
> System Board
> Dipswitch Settings
> Memory Module
*

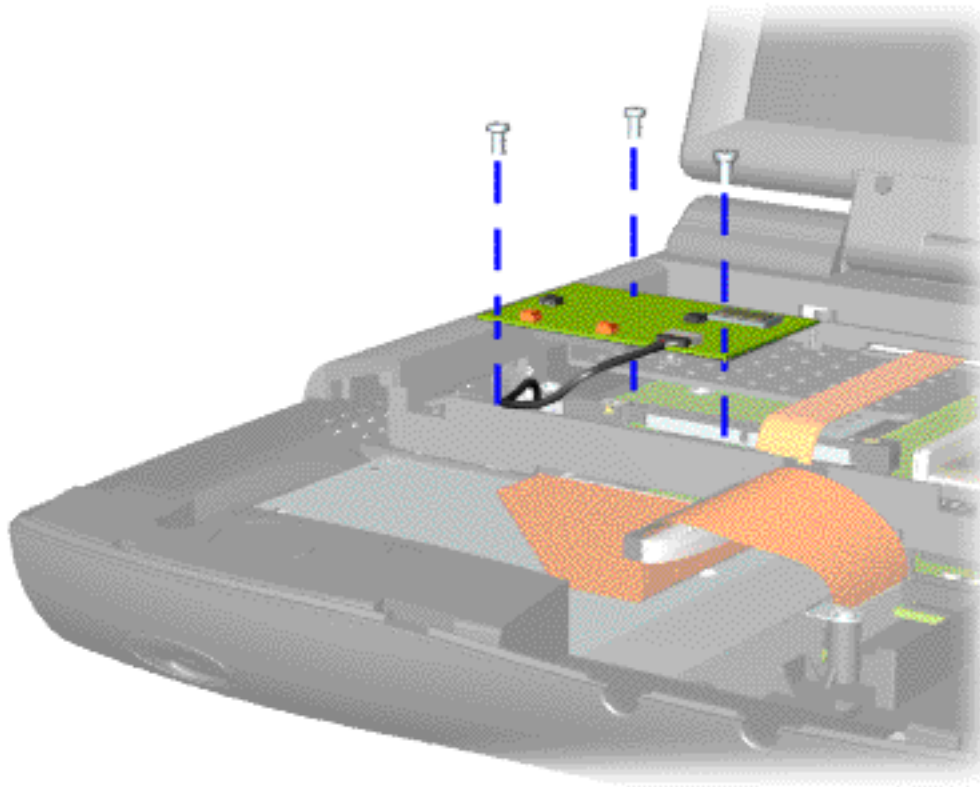

To remove the modem, complete the following steps:

1. Prepare the [computer for disassembly](#).
2. Remove the [palmrest cover with touch pad](#).
3. Remove the [keyboard](#).
4. Remove the [heatspreader](#).
5. Remove three screws securing modem and pull the modem off the connector on the system board.

[Next Step](#)

MAINTENANCE & SERVICE GUIDE

for Prosignia 150 Series Computer

[Index Page](#)
[Product Description](#)

[Preface -or- Notice](#)
[Illustrated Parts Catalog](#)

[Specifications](#)
[Troubleshooting](#)

[Battery Pack](#)
[Removal & Replacement](#)

Removal & Replacement Display Panel Assembly

*
> Preliminaries
> Serial Number Location
> Battery Pack
> Touchpad Assembly
> Keyboard
> Heatspreader
> Processor
> Hard Drive
> CD/DVD Drive
> Battery Charger Board
> Modem
> Display
> CPU cover
> Speakers
> Diskette Drive
> Fan Assembly
> System Board
> Dipswitch Settings
> Memory Module
*

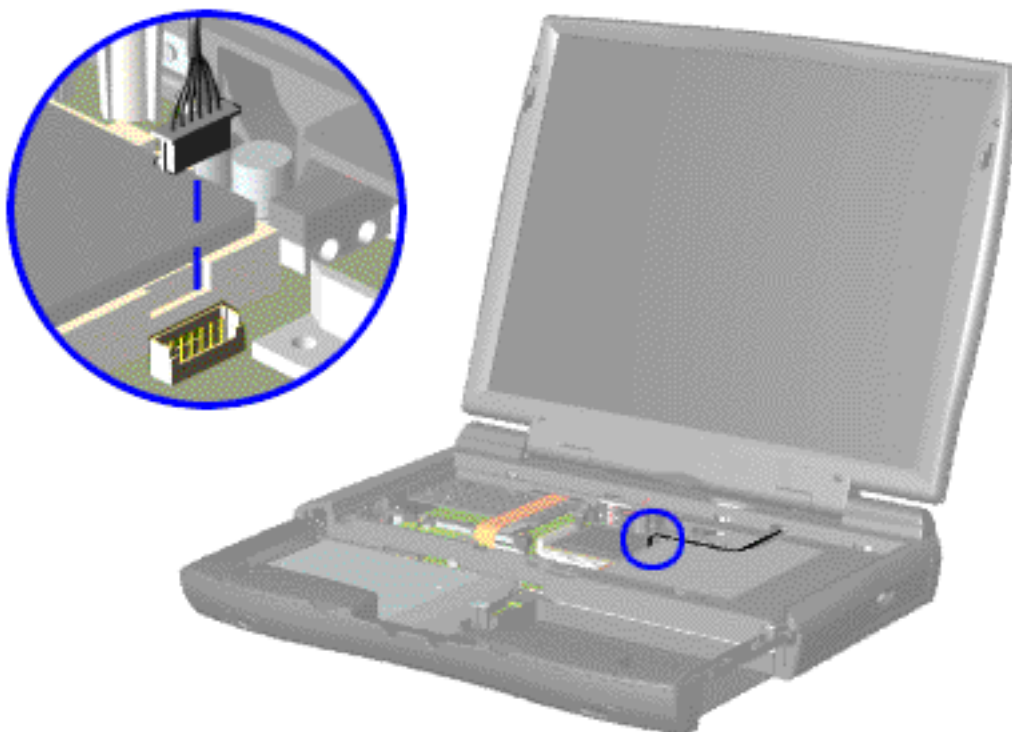

To remove the display panel assembly, complete the following steps:

1. [Prepare the computer for disassembly.](#)
2. Remove the [palmrest cover with touch pad.](#)
3. Remove the [keyboard.](#)
4. Remove the [heatspreader.](#)
5. Remove the [modem.](#)
6. Disconnect the backlight cable attached to the display panel assembly from the connector on the system board.

[Next Step](#)

MAINTENANCE & SERVICE GUIDE

for Prosignia 150 Series Computer

[Index Page](#)
[Product Description](#)

[Preface -or- Notice](#)
[Illustrated Parts Catalog](#)

[Specifications](#)
[Troubleshooting](#)

[Battery Pack](#)
[Removal & Replacement](#)

Removal & Replacement Upper CPU Cover

*
> Preliminaries
> Serial Number Location
> Battery Pack
> Touchpad Assembly
> Keyboard
> Heatspreader
> Processor
> Hard Drive
> CD/DVD Drive
> Battery Charger Board
> Modem
> Display
> CPU cover
> Speakers
> Diskette Drive
> Fan Assembly
> System Board
> Dipswitch Settings
> Memory Module
*

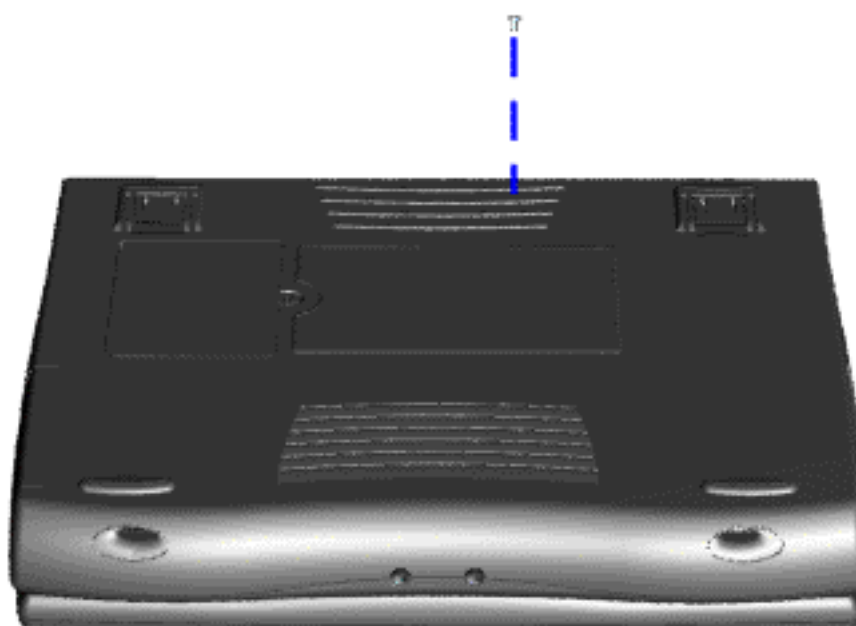

To remove the Upper CPU cover complete the following steps:

1. Prepare the [computer for disassembly](#).
2. Remove the [palmrest cover with touch pad](#).
3. Remove the [keyboard](#).
4. Remove the [heatspreader](#).
5. Remove the [hard drive](#).
6. Remove the [display panel assembly](#).
7. Remove the screw located under the bottom of the unit (rear) which secures the Upper CPU cover to the chassis.

[Next Step](#)

MAINTENANCE & SERVICE GUIDE

for Prosignia 150 Series Computer

[Index Page](#)
[Product Description](#)

[Preface -or- Notice](#)
[Illustrated Parts Catalog](#)

[Specifications](#)
[Troubleshooting](#)

[Battery Pack](#)
[Removal & Replacement](#)

Removal & Replacement Speaker Assembly

*
> Preliminaries
> Serial Number Location
> Battery Pack
> Touchpad Assembly
> Keyboard
> Heatspreader
> Processor
> Hard Drive
> CD/DVD Drive
> Battery Charger Board
> Modem
> Display
> CPU cover
> Speakers
> Diskette Drive
> Fan Assembly
> System Board
> Dipswitch Settings
> Memory Module
*

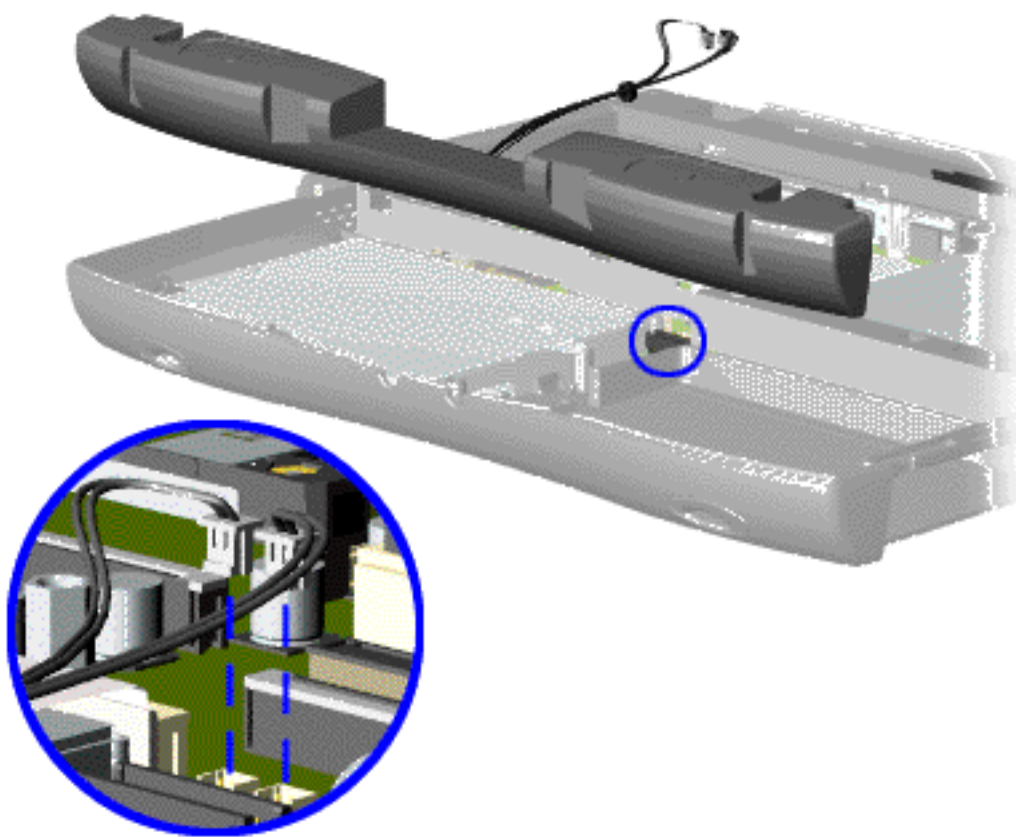

To remove the speaker assembly, complete the following steps:

1. Prepare the [computer for disassembly](#).
2. Remove the [palmrest cover with touch pad](#).
3. Remove the [keyboard](#).
4. Remove the [heatspreader](#).
5. Remove the [hard drive](#).
6. Remove the [display panel assembly](#).
7. Remove the [Upper CPU cover](#).
8. Remove the [charger board](#).

9. Disconnect the speaker cables from the system board and remove the speaker assembly from the chassis.

To replace the speaker assembly, reverse the previous procedures.

MAINTENANCE & SERVICE GUIDE

for Prosignia 150 Series Computer

[Index Page](#)
[Product Description](#)

[Preface -or- Notice](#)
[Illustrated Parts Catalog](#)

[Specifications](#)
[Troubleshooting](#)

[Battery Pack](#)
[Removal & Replacement](#)

Removal & Replacement Diskette Drive

*
> Preliminaries
> Serial Number Location
> Battery Pack
> Touchpad Assembly
> Keyboard
> Heatspreader
> Processor
> Hard Drive
> CD/DVD Drive
> Battery Charger Board
> Modem
> Display
> CPU cover
> Speakers
> Diskette Drive
> Fan Assembly
> System Board
> Dipswitch Settings
> Memory Module
*

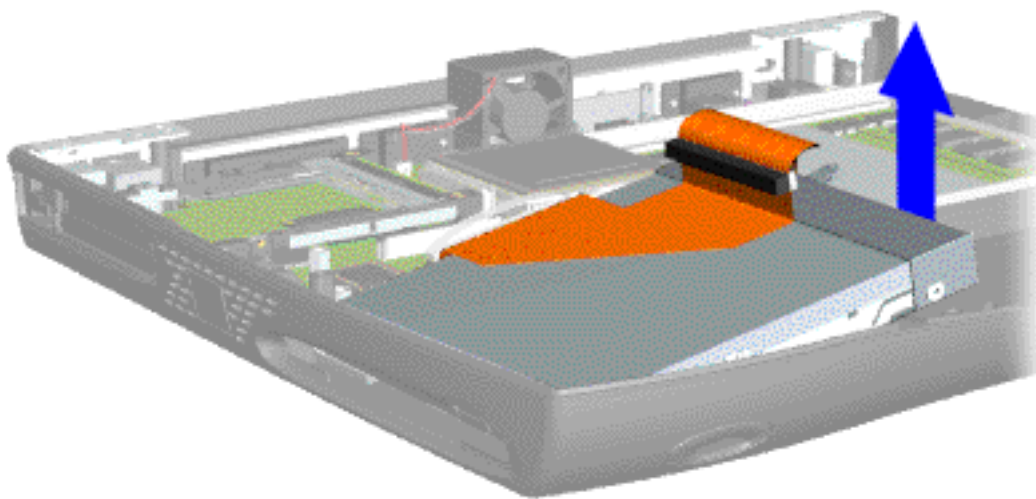

To remove the diskette drive, complete the following steps:

1. [Prepare the computer for disassembly.](#)
2. [Remove the palmrest cover with touch pad.](#)
3. [Remove the keyboard.](#)
4. [Remove the heatspreader.](#)
5. [Remove the hard drive.](#)
6. [Remove the display panel assembly.](#)
7. [Remove the upper CPU cover.](#)
8. [Remove the screw from the diskette drive and lift up the diskette drive.](#)
9. [Disconnect the diskette drive data cable from the system board.](#)

To replace the diskette drive, reverse the previous procedures.

NOTE: Ensure the diskette drive eject lever is properly inserted in the chassis slot, when replacing the diskette drive.

MAINTENANCE & SERVICE GUIDE

for Prosignia 150 Series Computer

[Index Page](#)
[Product Description](#)

[Preface -or- Notice](#)
[Illustrated Parts Catalog](#)

[Specifications](#)
[Troubleshooting](#)

[Battery Pack](#)
[Removal & Replacement](#)

Removal & Replacement Fan Assembly

*
> Preliminaries
> Serial Number Location
> Battery Pack
> Touchpad Assembly
> Keyboard
> Heatspreader
> Processor
> Hard Drive
> CD/DVD Drive
> Battery Charger Board
> Modem
> Display
> CPU cover
> Speakers
> Diskette Drive
> Fan Assembly
> System Board
> Dipswitch Settings
> Memory Module
*

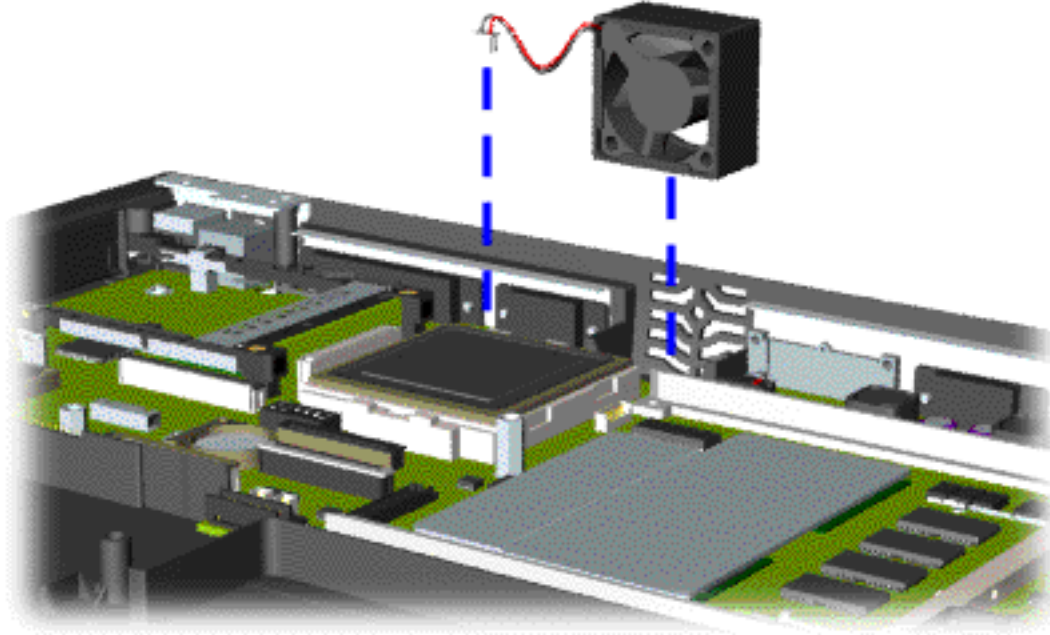

To remove the fan assembly, complete the following steps:

1. Prepare the [computer for disassembly](#).
2. Remove the [palmrest cover with touch pad](#).
3. Remove the [keyboard](#).
4. Remove the [heatspreader](#).
5. Remove the [display panel assembly](#).
6. Remove the [hard drive](#).
7. Remove the [Upper CPU cover](#).
8. Lift the fan assembly from the chassis slot and disconnect the fan cable from the connector on the system board.

[Next Step](#)

MAINTENANCE & SERVICE GUIDE

for Prosignia 150 Series Computer

[Index Page](#)
[Product Description](#)

[Preface -or- Notice](#)
[Illustrated Parts Catalog](#)

[Specifications](#)
[Troubleshooting](#)

[Battery Pack](#)
[Removal & Replacement](#)

Removal & Replacement

System Board

To remove the system board, complete the following steps:

IMPORTANT: When replacing the system board remove the memory module on the system board.

1. Prepare the [computer for disassembly](#).
2. Remove the [palmrest cover with touch pad](#).
3. Remove the [keyboard](#).
4. Remove the [heatspreader](#).
5. Remove the [processor](#).
6. Remove the [modem](#).
7. Remove the [hard drive](#).
8. Remove the [display panel assembly](#).
9. Remove the [Upper CPU Cover](#).
10. Remove the [battery charger board](#).
11. Remove the [diskette drive](#).
12. Remove the [CD or DVD drive](#).
13. Remove the [fan assembly](#).
14. Disconnect the [speaker assembly](#) cables.

[Next Step](#)

MAINTENANCE & SERVICE GUIDE

for Prosignia 150 Series Computer

[Index Page](#)
[Product Description](#)

[Preface -or- Notice](#)
[Illustrated Parts Catalog](#)

[Specifications](#)
[Troubleshooting](#)

[Battery Pack](#)
[Removal & Replacement](#)

Removal & Replacement System Board

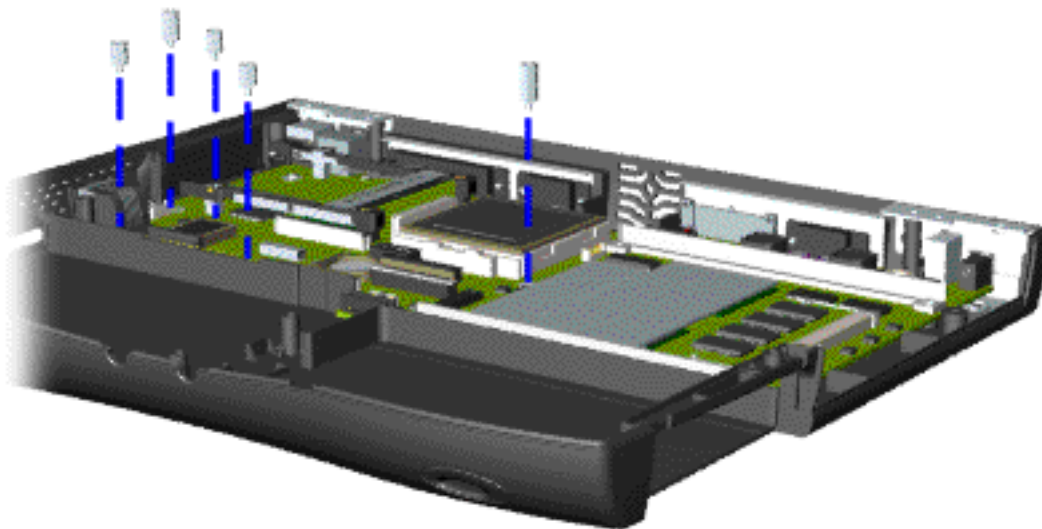

15. Remove five standoffs from the system board.

[Next Step](#)

MAINTENANCE & SERVICE GUIDE

for Prosignia 150 Series Computer

[Index Page](#)
[Product Description](#)

[Preface -or- Notice](#)
[Illustrated Parts Catalog](#)

[Specifications](#)
[Troubleshooting](#)

[Battery Pack](#)
[Removal & Replacement](#)

Removal & Replacement CD/DVD Drive

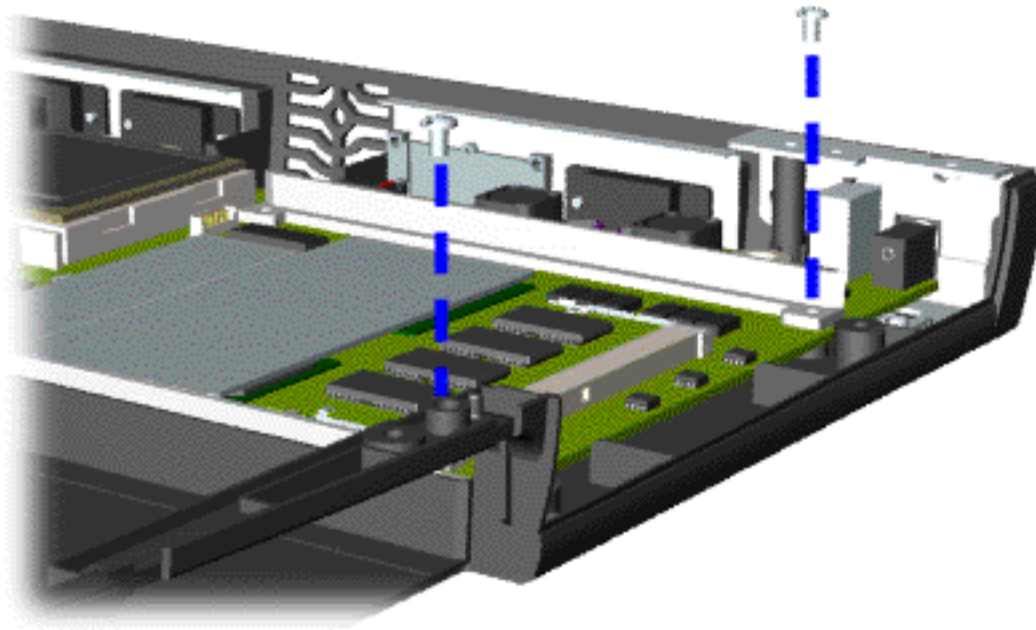

16. Remove two screws from the DVD or CD Drive mounting rails and remove the mounting rails from the system board.

[Next Step](#)

MAINTENANCE & SERVICE GUIDE

for Prosignia 150 Series Computer

[Index Page](#)
[Product Description](#)

[Preface -or- Notice](#)
[Illustrated Parts Catalog](#)

[Specifications](#)
[Troubleshooting](#)

[Battery Pack](#)
[Removal & Replacement](#)

Removal & Replacement System Board

17. Remove three screws from the system board.

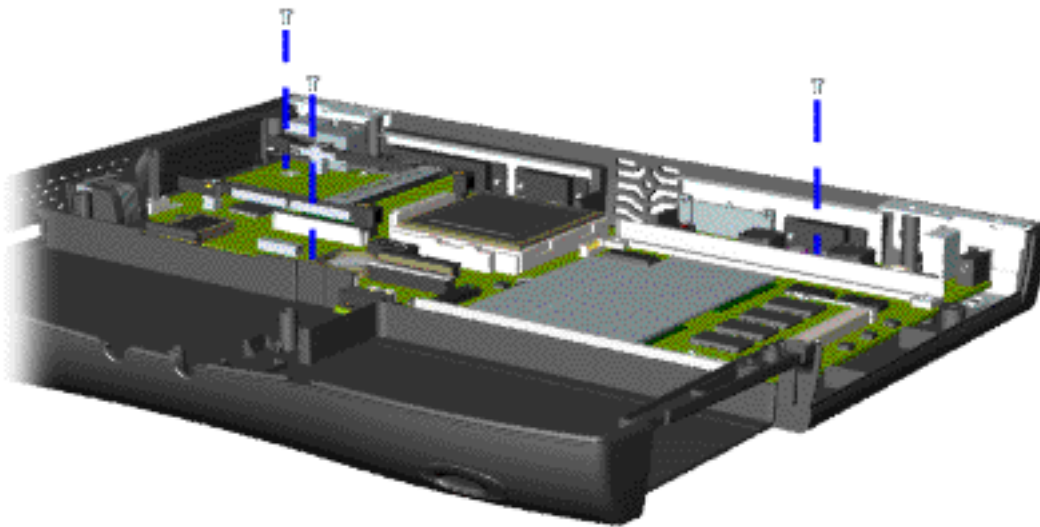

The [Ethernet Connector Plug](#) must be removed before removing the system board. After removing the screws and standoffs from the system board, remove the Ethernet Connector Plug (located on the left side of the base enclosure) by pushing it out from the inside of the chassis.

[Next Step](#)

MAINTENANCE & SERVICE GUIDE

for Prosignia 150 Series Computer

[Index Page](#)
[Product Description](#)

[Preface -or- Notice](#)
[Illustrated Parts Catalog](#)

[Specifications](#)
[Troubleshooting](#)

[Battery Pack](#)
[Removal & Replacement](#)

Product Description

Left Side Components

*
> Models
> Features & Controls
> Front Bezel Buttons
> Front Bezel Lights
> Left Side Components
> Right side Components
> Bottom of Unit
> Rear Connectors
> Power Managing
*

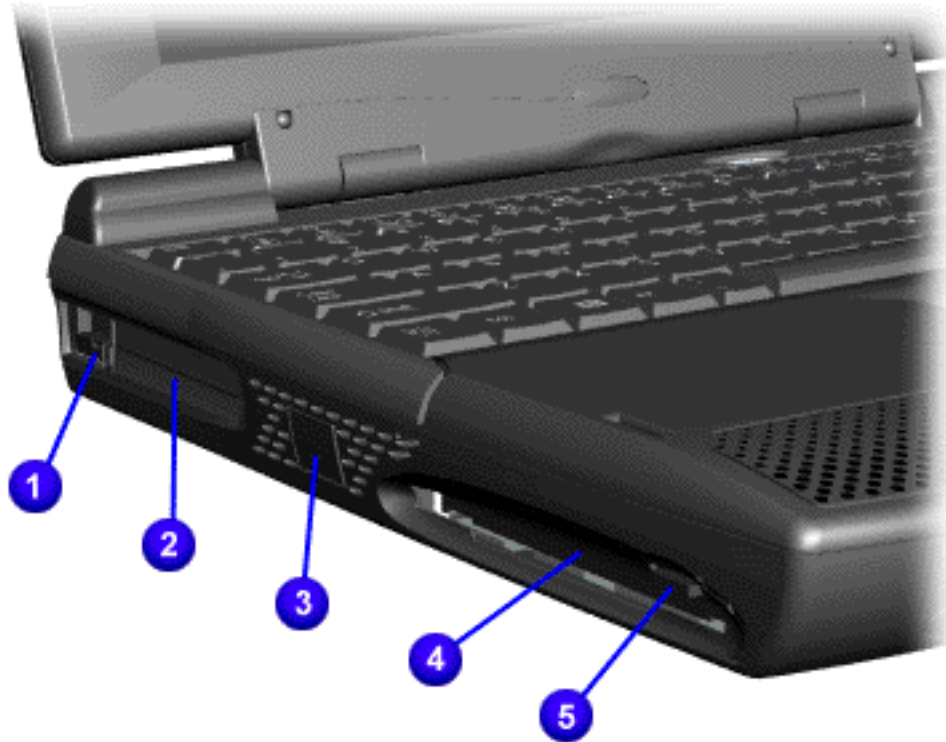

1. PC Card Eject Lever
2. PC Card Slot
3. Ethernet Connector Plug
4. Diskette Drive Slot
5. Diskette Eject Button

MAINTENANCE & SERVICE GUIDE

for Prosignia 150 Series Computer

[Index Page](#)
[Product Description](#)

[Preface -or- Notice](#)
[Illustrated Parts Catalog](#)

[Specifications](#)
[Troubleshooting](#)

[Battery Pack](#)
[Removal & Replacement](#)

Product Description

Models & Features

*	Display	12.1" TFT 14.1" TFT
> Models		
> Features & Controls	AMD K6-2 Processors	350 380 400 433 475
> Front Bezel Buttons		
> Front Bezel Lights	Cache	1MB
> Left Side Components	Hard Drives	4.0 GB 4.3 GB 6.4 GB 10.0 GB
> Right side Components		
> Bottom of Unit	CD Drive	24x Max CD-ROM
> Rear Connectors	DVD Drive	4x DVD-ROM Drive
> Power Managing	Modem	56K V.90 PCI Modem
imms		

MAINTENANCE & SERVICE GUIDE

for Prosignia 150 Series Computer

[Index Page](#)
[Product Description](#)

[Preface -or- Notice](#)
[Illustrated Parts Catalog](#)

[Specifications](#)
[Troubleshooting](#)

[Battery Pack](#)
[Removal & Replacement](#)

Product Description

Features & Controls

*
> Models
> Features & Controls
> Front Bezel Buttons
> Front Bezel Lights
> Left Side Components
> Right side Components
> Bottom of Unit
> Rear Connectors
> Power Managing
*

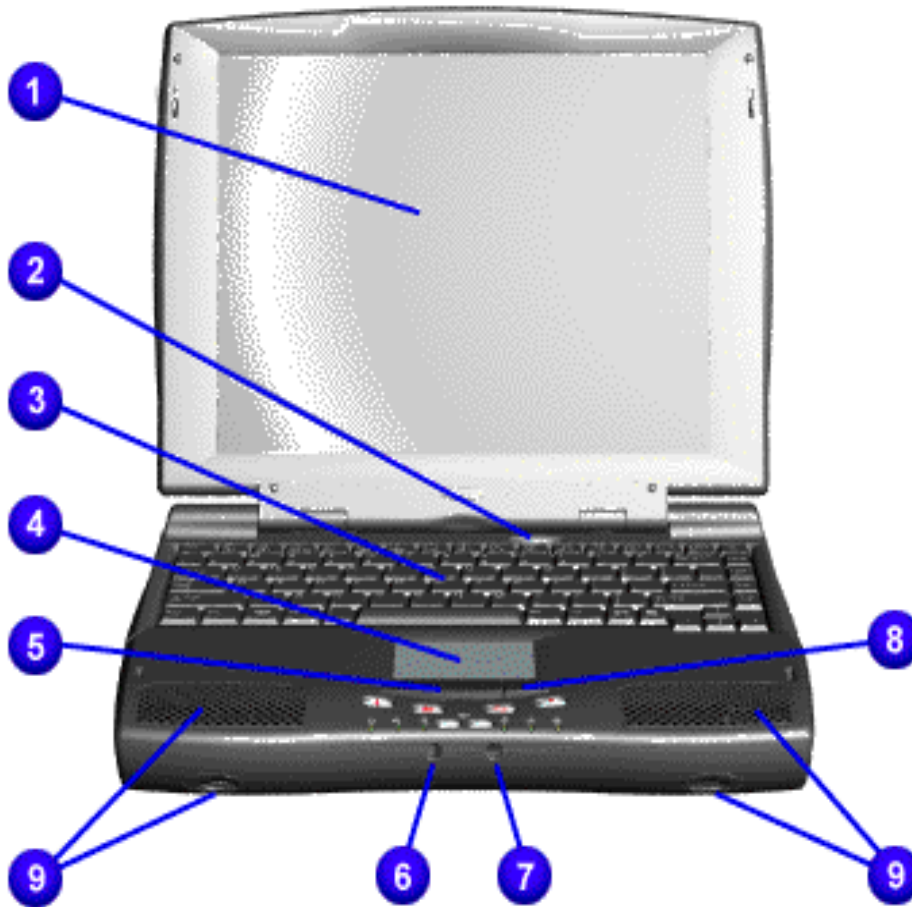

1. Display
2. Power (On/Off) Button
3. Keyboard
4. Touch Pad
5. Touch Pad Button (Left)
6. Headphone Jack
7. Microphone Jack
8. Touch Pad Button (Right)
9. Integrated Speakers and Ports

MAINTENANCE & SERVICE GUIDE

for Prosignia 150 Series Computer

[Index Page](#)
[Product Description](#)

[Preface -or- Notice](#)
[Illustrated Parts Catalog](#)

[Specifications](#)
[Troubleshooting](#)

[Battery Pack](#)
[Removal & Replacement](#)

Product Description

Front Bezel Buttons

*
> Models
> Features & Controls
> Front Bezel Buttons
> Front Bezel Lights
> Left Side Components
> Right side Components
> Bottom of Unit
> Rear Connectors
> Power Managing
*

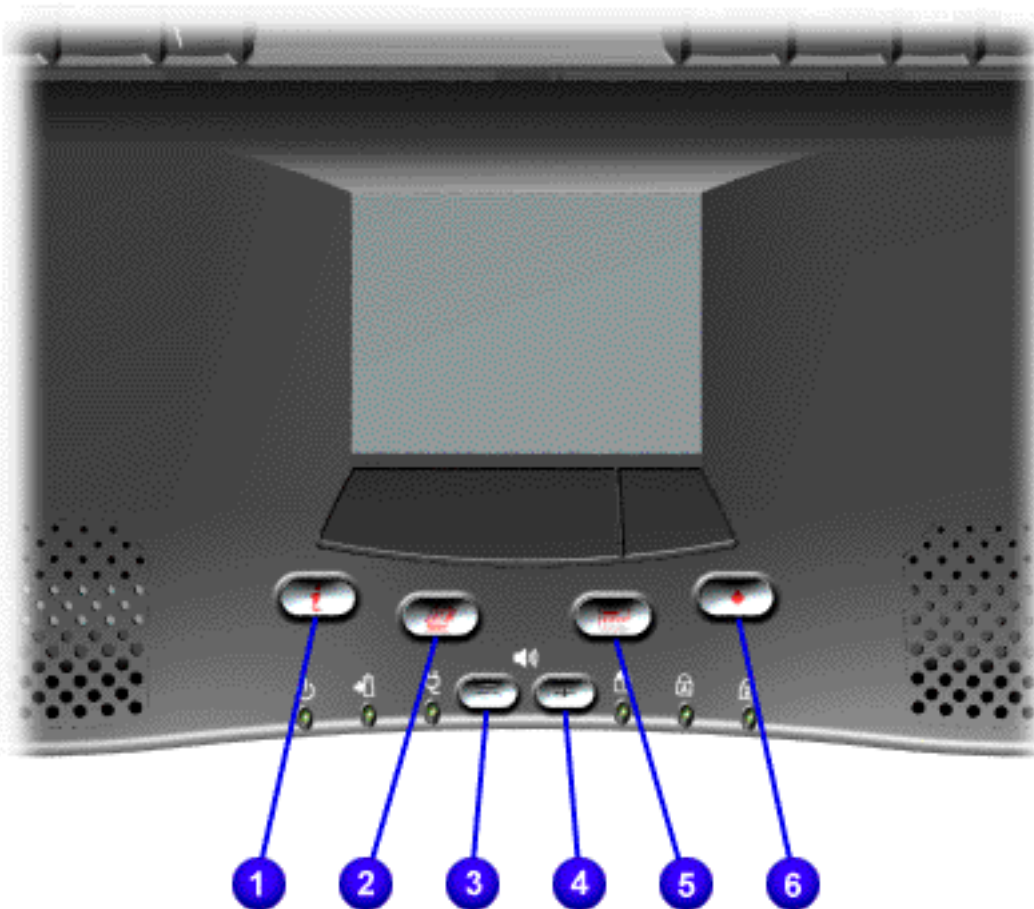

1. Instant Internet Access Button
2. Instant E-mail Button
3. Volume Down Button
4. Volume Up Button
5. Instant Calendar Button
6. User-Defined/Programmable Button

MAINTENANCE & SERVICE GUIDE

for Prosignia 150 Series Computer

[Index Page](#)
[Product Description](#)

[Preface -or- Notice](#)
[Illustrated Parts Catalog](#)

[Specifications](#)
[Troubleshooting](#)

[Battery Pack](#)
[Removal & Replacement](#)

Product Description

Front Bezel Lights

*
> Models
> Features & Controls
> Front Bezel Buttons
> Front Bezel Lights
> Left Side Components
> Right side Components
> Bottom of Unit
> Rear Connectors
> Power Managing
*

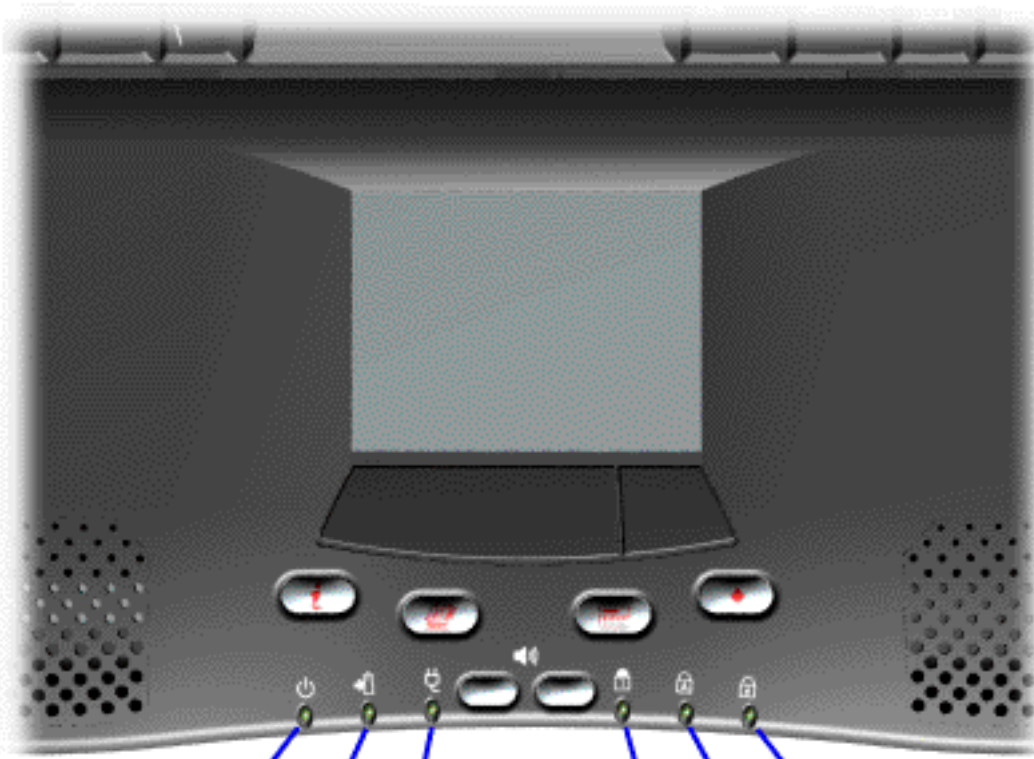

1. Power Light
2. Battery Charge Light
3. Power Cord Light
4. Num Lock Light
5. Cap Lock Light
6. Scroll Lock Light

MAINTENANCE & SERVICE GUIDE

for Prosignia 150 Series Computer

[Index Page](#)
[Product Description](#)

[Preface -or- Notice](#)
[Illustrated Parts Catalog](#)

[Specifications](#)
[Troubleshooting](#)

[Battery Pack](#)
[Removal & Replacement](#)

Product Description

Right Side Components

*
> Models
> Features & Controls
> Front Bezel Buttons
> Front Bezel Lights
> Left Side Components
> Right side Components
> Bottom of Unit
> Rear Connectors
> Power Managing
*

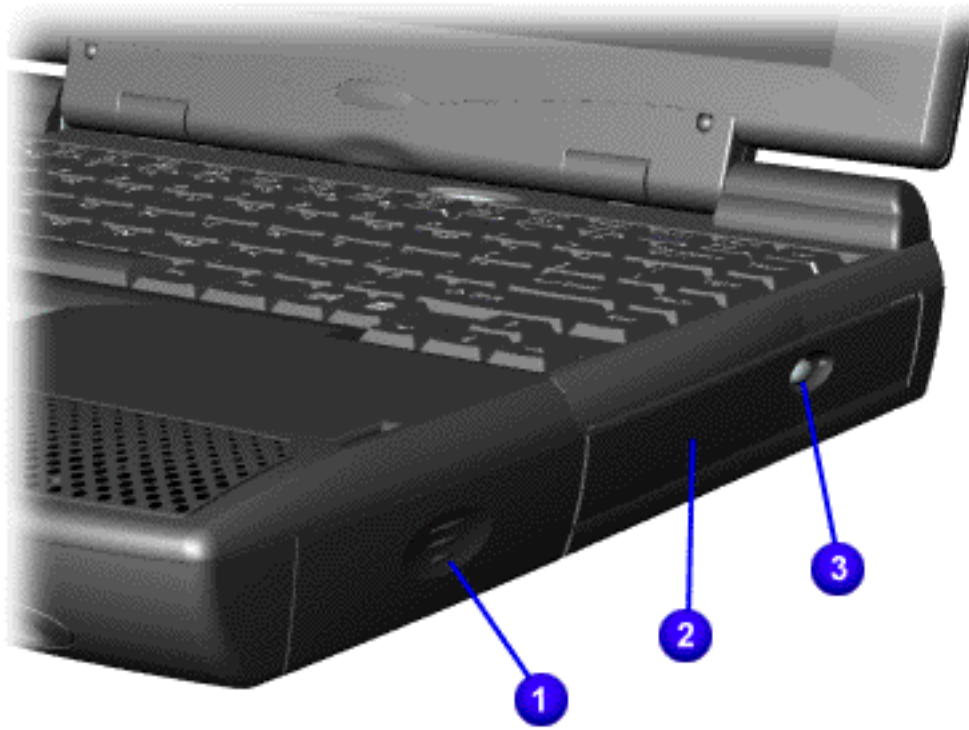

1. Battery Compartment
2. DVD or CD Drive Manual Eject Hole
3. DVD or CD Drive Eject Button

MAINTENANCE & SERVICE GUIDE

for Prosignia 150 Series Computer

[Index Page](#)
[Product Description](#)

[Preface -or- Notice](#)
[Illustrated Parts Catalog](#)

[Specifications](#)
[Troubleshooting](#)

[Battery Pack](#)
[Removal & Replacement](#)

Product Description

Bottom of Unit

*
> Models
> Features & Controls
> Front Bezel Buttons
> Front Bezel Lights
> Left Side Components
> Right side Components
> Bottom of Unit
> Rear Connectors
> Power Managing
*

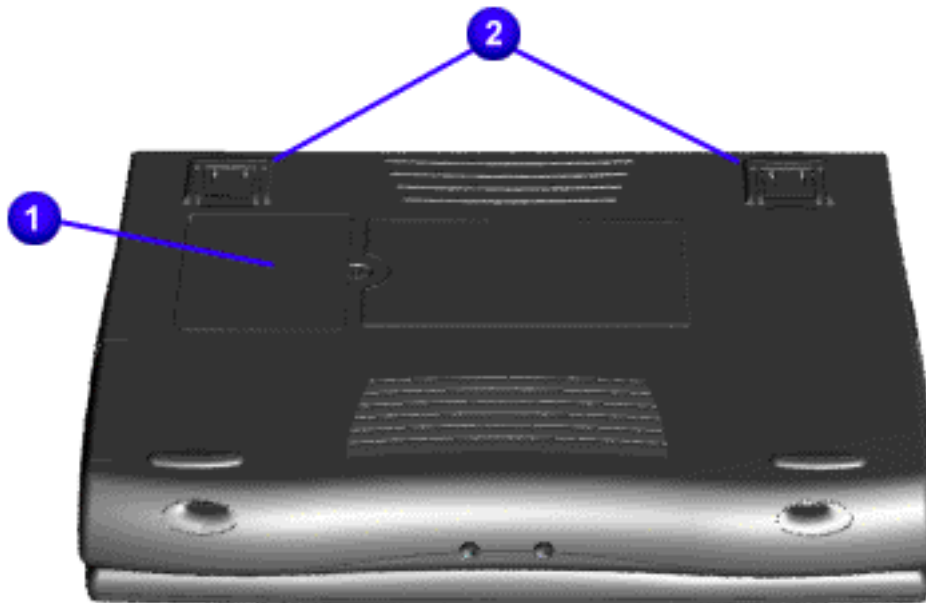

1. Memory Compartment Door
2. Stand Feet

MAINTENANCE & SERVICE GUIDE

for Prosignia 150 Series Computer

[Index Page](#)
[Product Description](#)

[Preface -or- Notice](#)
[Illustrated Parts Catalog](#)

[Specifications](#)
[Troubleshooting](#)

[Battery Pack](#)
[Removal & Replacement](#)

Product Description

Rear Connectors

*
> Models
> Features & Controls
> Front Bezel Buttons
> Front Bezel Lights
> Left Side Components
> Right side Components
> Bottom of Unit
> Rear Connectors
> Power Managing
*

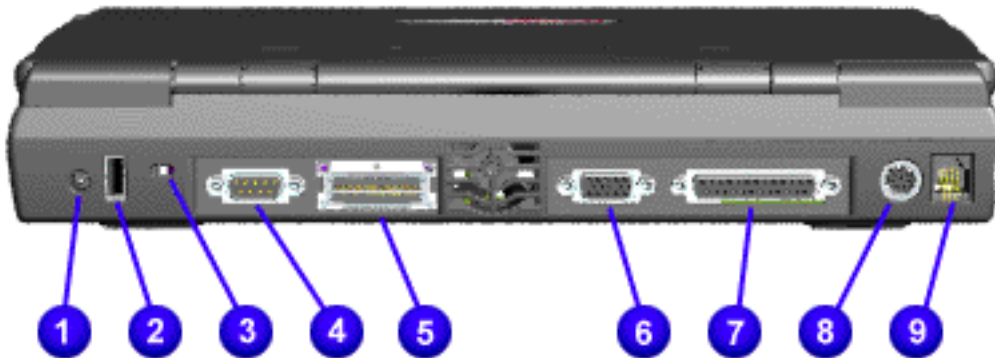

1. AC Adapter
2. Universal Serial Bus
3. Security Slot
4. Serial Port
5. Port Replicator
6. External Monitor Port
7. Parallel Printer Port
8. Keyboard/Mouse Port
9. Modem Jack

MAINTENANCE & SERVICE GUIDE

for Prosignia 150 Series Computer

[Index Page](#)
[Product Description](#)

[Preface - or- Notice](#)
[Illustrated Parts Catalog](#)

[Specifications](#)
[Troubleshooting](#)

[Battery Pack](#)
[Removal & Replacement](#)

Power Management for Windows 98

The following power management features are available for conserving AC power and extending battery operating time:

- Power Management Settings
- [Sleep](#)
- [Hibernation](#)
- [Battery operating time](#)
- [Rebooting After a Lockup](#)
- [Servicing Your Computer - Full Off Mode](#)

Power Management Settings

Depending on your patterns of computer use, you can set different levels of power management. These different power management levels can be activated based on the amount of time passed since the last system activity. System activity examples include keyboard or mouse movement, CD or DVD playback (while under program control that monitors Sleep), and modem use.

You can select different conditions or power schemes through Power Management. The optional settings are Home/Office Desk, Portable/ Laptop, and Always On. From the default settings, you can change the following settings:

- the System goes to Sleep (Standby) mode
- the screen times out and goes blank
- the hard drive spins down

Each of these system components will go to sleep after the selected or default periods of inactivity. (The setting for hard drive must be less than or equal to the setting for System.)

IMPORTANT: If you're on a network, it's recommended that you set System Standby to Never.

There are five categories of power management settings under the Control Panel. The default setting for each feature is listed below in the tables.

Power Management Properties		
Tab: Power Schemes:	Plugged in	Running on Batteries
Always on System Standby:	Never	15 minutes
Turn OFF Monitor	After 15 minutes	After 10 minutes
Always on System Standby:	After 15 minutes	After 10 minutes

Power Management Properties		
Tab: ALARMS::		
Low Battery Alarm:	10%	
Critical Battery Alarm	0%	
Alarm Actions:	X Display Message Notification	
	Text Action	No Action

Power Management Properties	
Tab: POWER METER:	Default
Tab: ADVANCED	Default

Display Properties
Tab: Monitor: Laptop Display (Maximum resolution according to unit display size)

Sleep

You can select Sleep mode instead of turning off the computer when you have finished using it. This allows the computer to wake up faster than turning it completely off and saves power over the active (On) mode. Compaq Prosignia Series Notebook computers have two levels of sleep, Hibernation and Sleep.

Hibernation – by pushing the power button once your computer will perform a save to disk followed by a shut down of the computer into Off mode.

Sleep – is a low power mode, also referred to as Standby mode. While in Sleep mode, your computer will maintain system information and open files. Unsaved information will be lost if you turn off your system prior to system wake-up, or if you lose power while using the AC adapter.

	CAUTION: While in Sleep mode, your computer will maintain system information and open files. Unsaved information will be lost if you turn off your system prior to system wake-up, or if you lose power while using the AC adapter.
---	---

Hibernation Mode

Hibernation helps conserve battery life and protects your data. Hibernation can be a routine power saving event, or can be the result of a low battery condition. As it enters Hibernation your computer will display a progress screen, as it automatically saves the machine state before it shuts down and turns itself off. Your computer will automatically go into Hibernation, when the battery has little power left, or when the system (operating on battery power) has been in Sleep mode for more than an hour. You can also manually initiate Hibernation by pressing the power button once while the system is active. To restore the computer's previous state, simply press the power button once again. While waking up, the computer will display a progress screen.

The following table shows the conditions and indicators for getting in and out of the various power management modes, Sleep, Hibernation, and Off.

Mode	To Initiate	To End	Indicators
Sleep	Manual keys combination - Fn+ F4	Press any key	Flashing green Power LED
	Time Out Default 15 minutes. If on Battery power (system will not go to Sleep if on AC power)		
Hibernate	Manual - Press Power Button once	Press Power Button once	No Power LED, blank screen
	Time Out Default If low battery or after 1 hour of sleep (system will not Hibernate if on AC power)		
Off	Perform normal Windows shutdown via the start button, or press and hold down the power button for 4 seconds	Press Power Button once	No Power LED, blank screen

Servicing Your Computer, Full Off Mode

If you need to install or replace components in your system, you must turn the computer off completely. Follow the instructions above for properly putting the computer into Off mode, unplug from the outlet, and remove the battery ([see battery section for instruction on removing battery](#)).

Rebooting After a Lockup

Occasionally you may encounter a frozen keyboard or a locked screen. To reboot your computer (as if from a cold start) press and hold down the Power Button for at least four seconds, which will cause a manual shutdown. Then, restart it with a single press of the Power Button. If it still doesn't recover, press the Power Button and hold it for four seconds to shut it down, then, remove the battery or unplug the AC power for at least 30 seconds. Reinsert the battery or reconnect AC power and press the Power Button once to reboot.

Battery Operating Time

Battery operating time is affected by variables, such as the following:

- Power configuration settings
- Hardware configuration
- Software applications
- Installed options
- Display brightness
- Hard drive usage
- Power button
- Changes in operating temperature
- Type and number of installed PC Cards

For more information on increasing battery pack operating time, conditioning the battery pack, and disposing of a used battery pack, refer to the [Battery Pack Operations](#).

Return to the [Top of Page](#)

Return to [Product Description Index Page](#).

MAINTENANCE & SERVICE GUIDE

for Prosignia 150 Series Computer

[Index Page](#)
[Product Description](#)

[Preface -or- Notice](#)
[Illustrated Parts Catalog](#)

[Specifications](#)
[Troubleshooting](#)

[Battery Pack](#)
[Removal & Replacement](#)

Removal & Replacement System Board

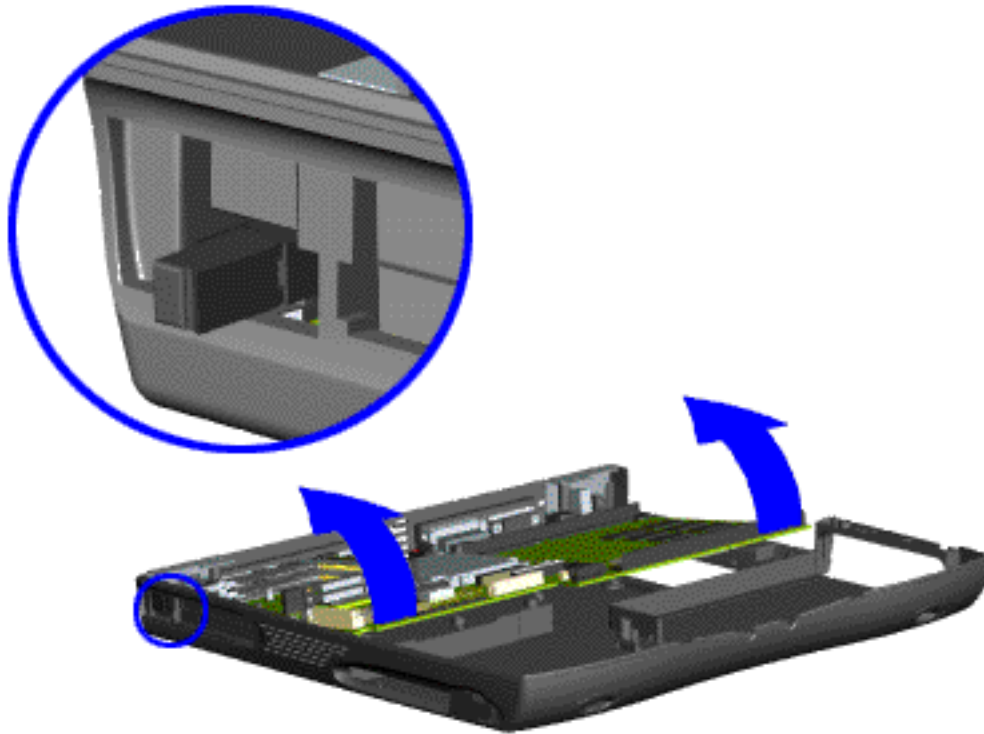

18. Pull the PCMCIA eject lever out (straight), lift up the right side of the system board and pull forward to remove the system board from the chassis.

IMPORTANT: Remove all cables from the system board.

To replace the system board, reverse the previous procedures.

Return to [Removal & Replacement Index Page](#).

Or go to [Dip Switch System Board Settings](#).

MAINTENANCE & SERVICE GUIDE

for Prosignia 150 Series Computer

[Index Page](#)
[Product Description](#)

[Preface -or- Notice](#)
[Illustrated Parts Catalog](#)

[Specifications](#)
[Troubleshooting](#)

[Battery Pack](#)
[Removal & Replacement](#)

Removal & Replacement Processor Dipswitch Settings



If the system board dip switch voltage settings are not correct, damage may occur to the computer and/or system board.

For the 350, 380, 400 & 475 MHz Processors:

only change settings 1-5 on SW1 **1**. Settings 6-10 vary by model and should not be changed when replacing the system board. Ensure the dip switch voltage settings (SW1 **1** and SW3 **3**) on the system board are correct for the computer model and processor voltage marked on the processor chip.

For the 433 MHz Processor:

You may change settings 1-5 as well as 10. Settings 6-9 vary by model and should not be changed when replacing the system board. Ensure the dip switch voltage settings (SW1 **1** and SW3 **3**) on the system board are correct for the computer model and processor voltage marked on the processor chip.

NOTE: The black area on the dip switch indicates the position of the switch.

- 1** Switch 1
- 3** Switch 3

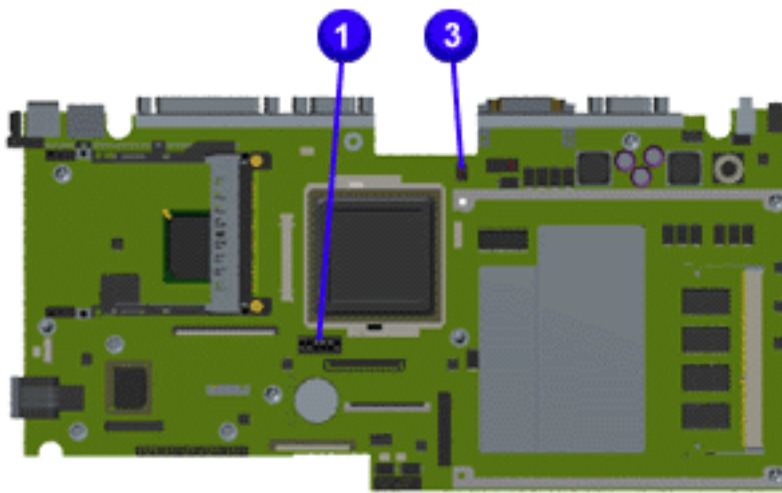

AMD K6-II 475 MHz, 2.2v

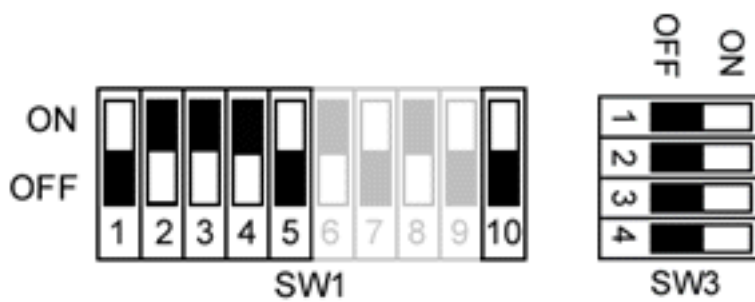

AMD K6-II 433 MHz, 2.2v



AMD K6-II 400 MHz, 2.2V



AMD K6-II 380 MHz, 2.2V



AMD K6-II 350 MHz, 2.2V



- [Preliminaries](#)
- [Serial Number Location](#)
- [Battery Pack](#)
- [Touchpad Assembly](#)
- [Keyboard](#)
- [Heatspreader](#)
- [Processor](#)
- [Hard Drive](#)
- [CD/DVD Drive](#)
- [Battery Charger Board](#)
- [Modem](#)
- [Display](#)
- [CPU cover](#)
- [Speakers](#)
- [Diskette Drive](#)
- [Fan Assembly](#)
- [System Board](#)
- [Dipswitch Settings](#)
- [Memory Module](#)

MAINTENANCE & SERVICE GUIDE

for Prosignia 150 Series Computer

[Index Page](#)
[Product Description](#)

[Preface -or- Notice](#)
[Illustrated Parts Catalog](#)

[Specifications](#)
[Troubleshooting](#)

[Battery Pack](#)
[Removal & Replacement](#)

Removal & Replacement Memory Module

*
> Preliminaries
> Serial Number Location
> Battery Pack
> Touchpad Assembly
> Keyboard
> Heatspreader
> Processor
> Hard Drive
> CD/DVD Drive
> Battery Charger Board
> Modem
> Display
> CPU cover
> Speakers
> Diskette Drive
> Fan Assembly
> System Board
> Dipswitch Settings
> Memory Module
*

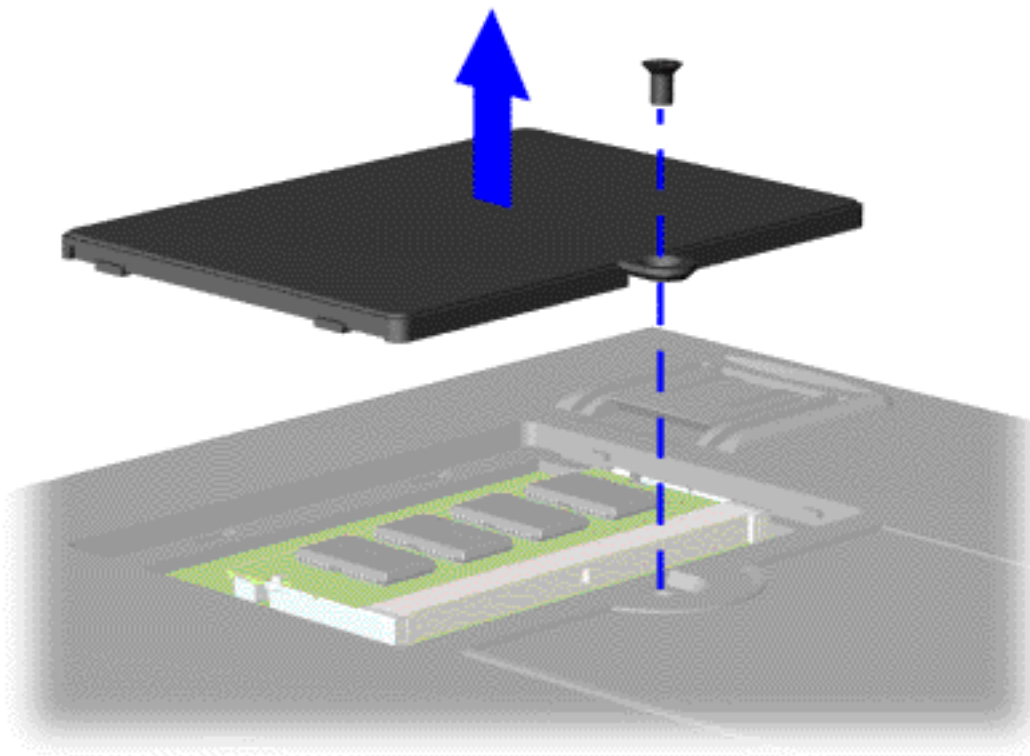

To remove the memory module, complete the following steps:

1. Prepare the [computer for disassembly](#).
2. Close the computer and turn the computer upside down.
3. Remove the screw from the memory module door, and slide the memory module door to the right.

[Next Step](#)

MAINTENANCE & SERVICE GUIDE

for Prosignia 150 Series Computer

[Index Page](#)
[Product Description](#)

[Preface -or- Notice](#)
[Illustrated Parts Catalog](#)

[Specifications](#)
[Troubleshooting](#)

[Battery Pack](#)
[Removal & Replacement](#)

Removal & Replacement Memory Module

4. Pull side levers to release the memory module and unplug the memory module from the system board.

To replace the memory module, reverse the previous procedures.

Return to [Removal & Replacement Index Page](#).

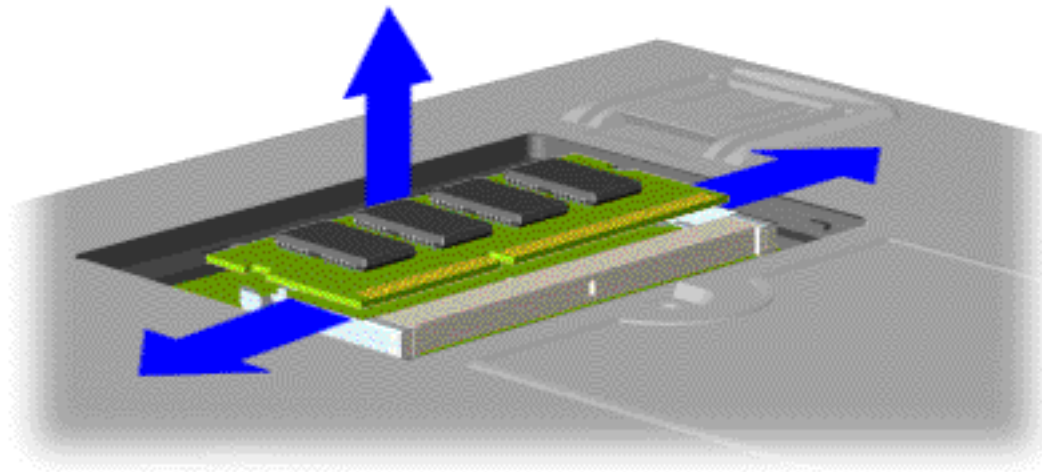

MAINTENANCE & SERVICE GUIDE

for Prosignia 150 Series Computer

[Index Page](#)
[Product Description](#)

[Preface -or- Notice](#)
[Illustrated Parts Catalog](#)

[Specifications](#)
[Troubleshooting](#)

[Battery Pack](#)
[Removal & Replacement](#)

Removal & Replacement Fan Assembly

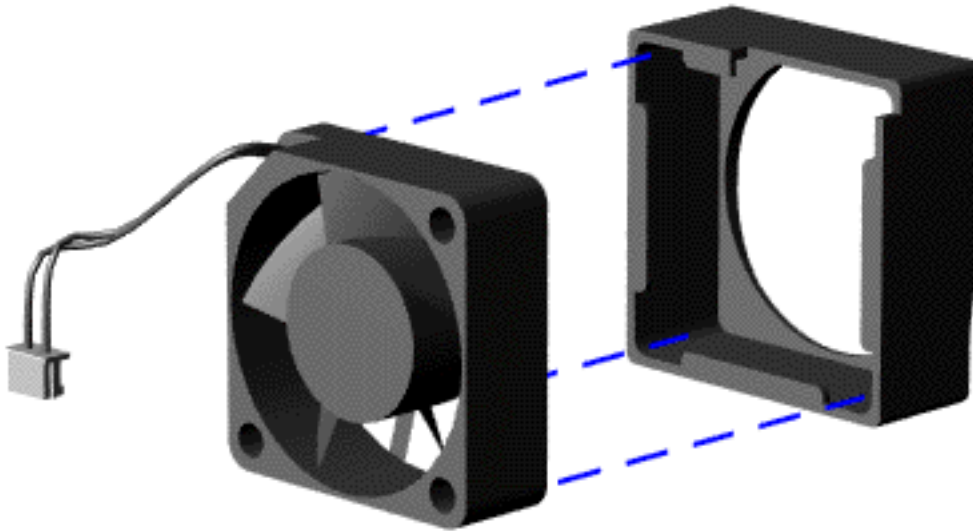

To remove the fan gasket, pull it away from the fan.

When replacing the fan assembly ensure the arrow (located on the top of the fan gasket) is pointing inward.

IMPORTANT:

To replace the fan assembly and gasket, reverse the previous procedures.

Return to [Removal & Replacement Index Page](#).

MAINTENANCE & SERVICE GUIDE

for Prosignia 150 Series Computer

[Index Page](#)
[Product Description](#)

[Preface -or- Notice](#)
[Illustrated Parts Catalog](#)

[Specifications](#)
[Troubleshooting](#)

[Battery Pack](#)
[Removal & Replacement](#)

Removal & Replacement

Removing CPU Cover

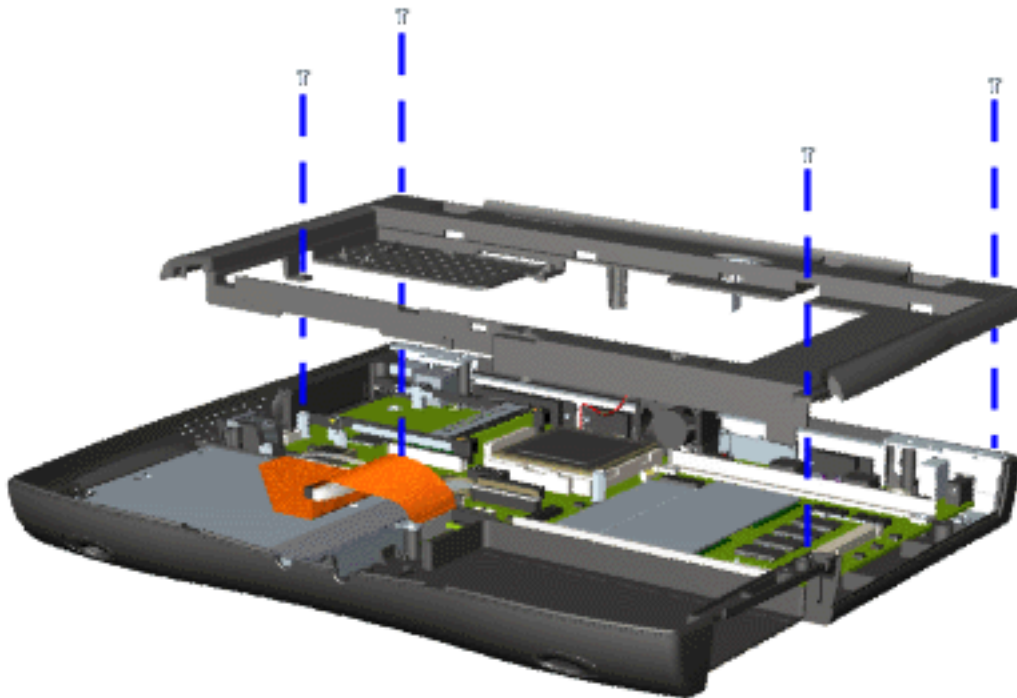

8. Remove four screws located on the top of the Upper CPU cover.

9. Lift the Upper CPU cover off the snaps on the chassis which will disconnect the power switch from the connector on the system board.

To replace the Upper CPU cover, reverse the previous procedures.

Return to [Removal & Replacement Index Page](#).

MAINTENANCE & SERVICE GUIDE

for Prosignia 150 Series Computer

[Index Page](#)
[Product Description](#)

[Preface -or- Notice](#)
[Illustrated Parts Catalog](#)

[Specifications](#)
[Troubleshooting](#)

[Battery Pack](#)
[Removal & Replacement](#)

Removal & Replacement Display Panel Assembly

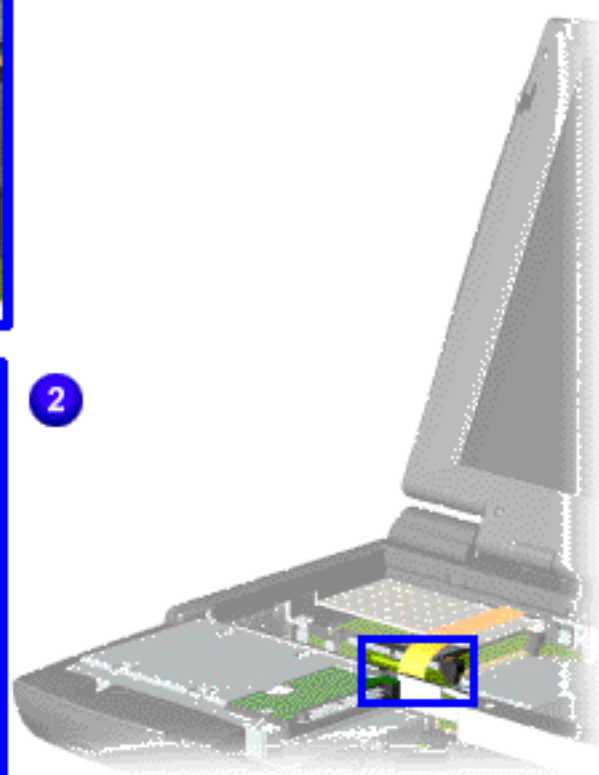
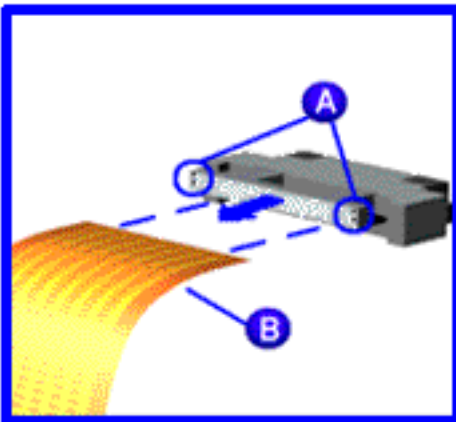
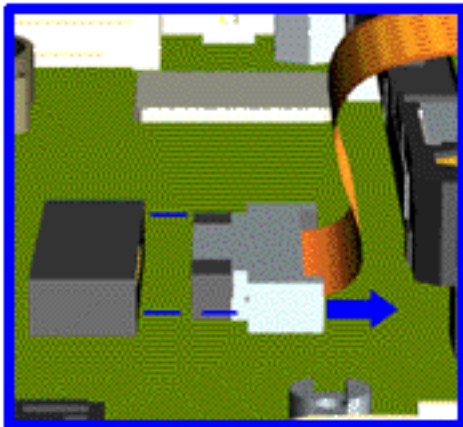

7. Disconnect the display panel assembly's flex data cable **1** from the Low Voltage Differential Signal (LVDS) connector on the system board.

8. Remove the display panel assembly's flex data cable from the **2** LVDS connector.

[Next Step](#)

MAINTENANCE & SERVICE GUIDE

for Prosignia 150 Series Computer

[Index Page](#)
[Product Description](#)

[Preface -or- Notice](#)
[Illustrated Parts Catalog](#)

[Specifications](#)
[Troubleshooting](#)

[Battery Pack](#)
[Removal & Replacement](#)

Removal & Replacement

Display Panel Assembly

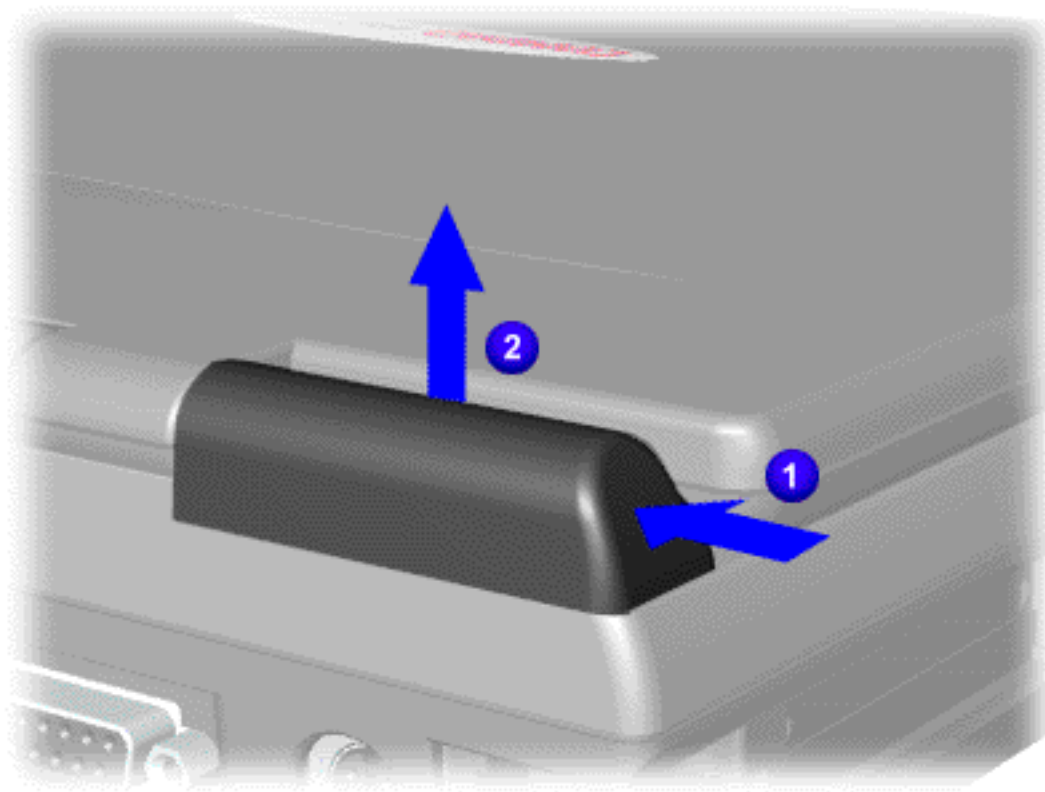

9. Close the display panel assembly and push back on top of the hinge covers **1** and lift up from the bottom edge of the hinge covers **2** to remove the covers off the chassis.

IMPORTANT: Carefully remove the display panel assembly hinge covers.

[Next Step](#)

MAINTENANCE & SERVICE GUIDE

for Prosignia 150 Series Computer

[Index Page](#)
[Product Description](#)

[Preface -or- Notice](#)
[Illustrated Parts Catalog](#)

[Specifications](#)
[Troubleshooting](#)

[Battery Pack](#)
[Removal & Replacement](#)

Removal & Replacement Display Panel Assembly

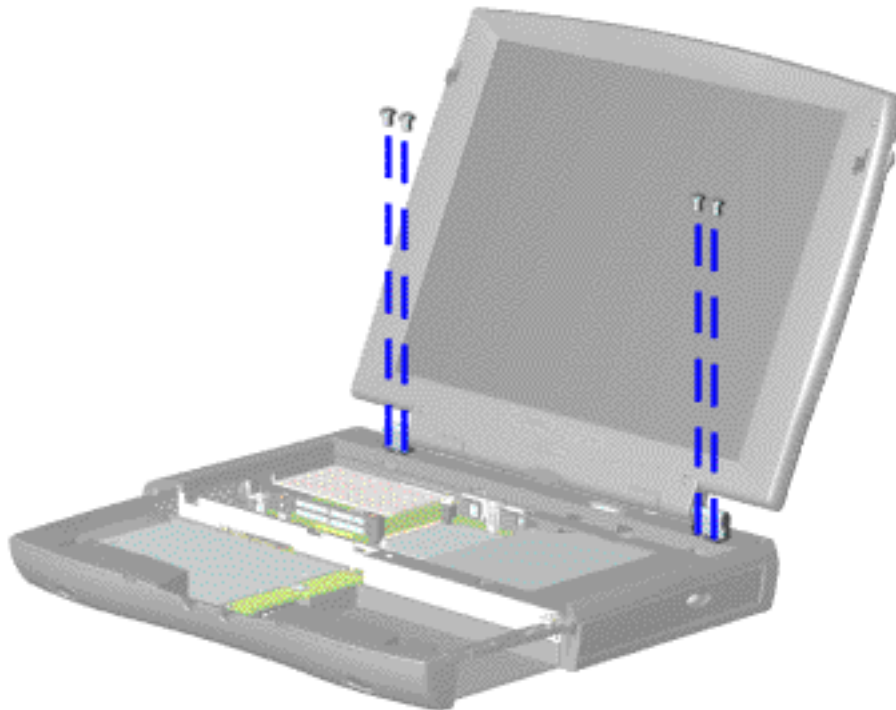

10. Support the back of the display panel assembly and remove two screws from each of the display panel hinges.

[Next Step](#)

MAINTENANCE & SERVICE GUIDE

for Prosignia 150 Series Computer

[Index Page](#)
[Product Description](#)

[Preface -or- Notice](#)
[Illustrated Parts Catalog](#)

[Specifications](#)
[Troubleshooting](#)

[Battery Pack](#)
[Removal & Replacement](#)

Removal & Replacement Display Panel Assembly

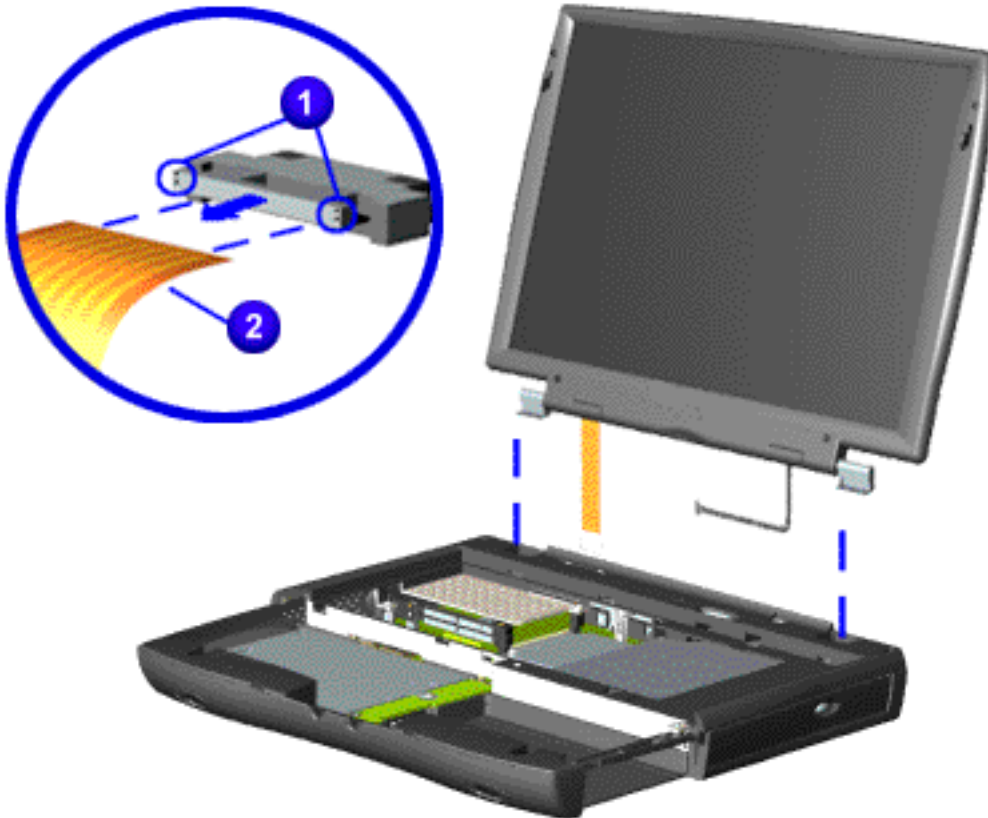

11. Remove the connector **1** on the end of the display flex cable **2**.

IMPORTANT: Compaq recommends replacing the LVDS interface connector on the display flex cable after removing.

 CAUTION: The connector on the end of the flex cable must be removed before the cable can be routed through the slot on the Upper CPU cover.

12. Gently pull the flex cable attached to the display panel assembly through the slot on the Upper CPU cover and remove the display panel assembly with flex and backlight cable attached.

NOTE: When removing the display panel assembly, observe the display panel assembly flex cable routing and position.

To replace the display panel assembly, reverse the previous procedures.

Return to [Removal & Replacement Index Page](#).

MAINTENANCE & SERVICE GUIDE

for Prosignia 150 Series Computer

[Index Page](#)
[Product Description](#)

[Preface -or- Notice](#)
[Illustrated Parts Catalog](#)

[Specifications](#)
[Troubleshooting](#)

[Battery Pack](#)
[Removal & Replacement](#)

Removal & Replacement Modem

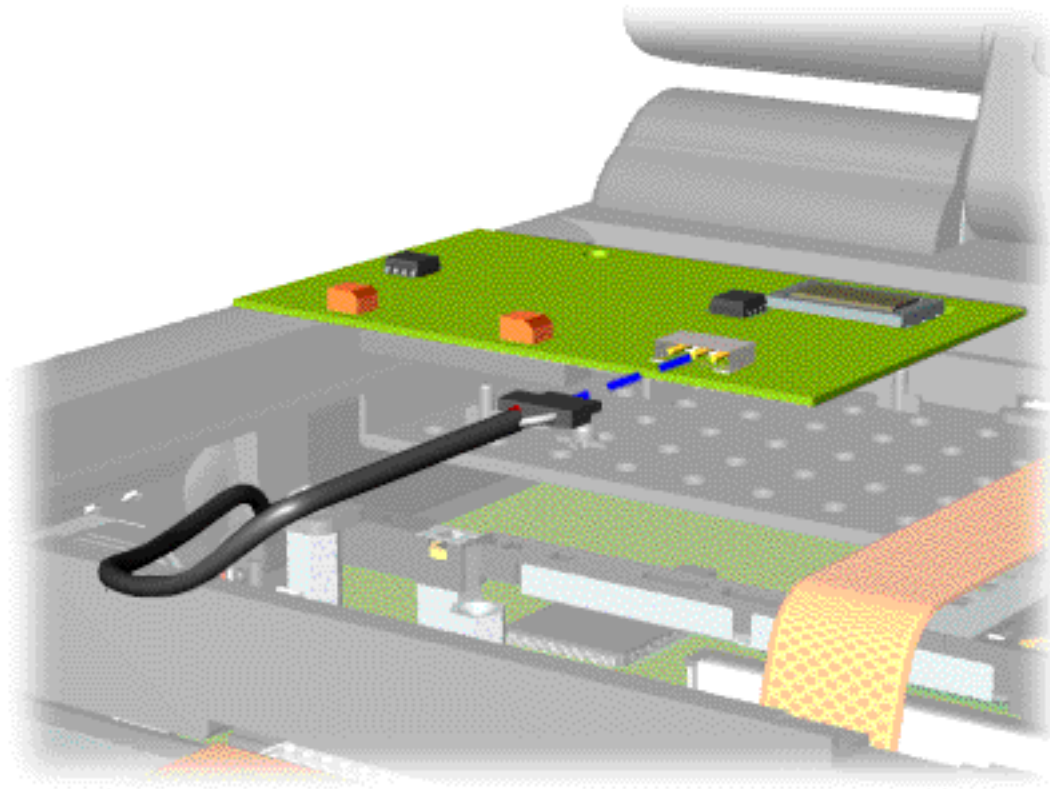

6. Disconnect the modem cable from the modem.

To replace the modem, reverse the previous procedures.

Return to [Removal & Replacement Index Page](#).

MAINTENANCE & SERVICE GUIDE

for Prosignia 150 Series Computer

[Index Page](#)
[Product Description](#)

[Preface -or- Notice](#)
[Illustrated Parts Catalog](#)

[Specifications](#)
[Troubleshooting](#)

[Battery Pack](#)
[Removal & Replacement](#)

Removal & Replacement CD or DVD Drive

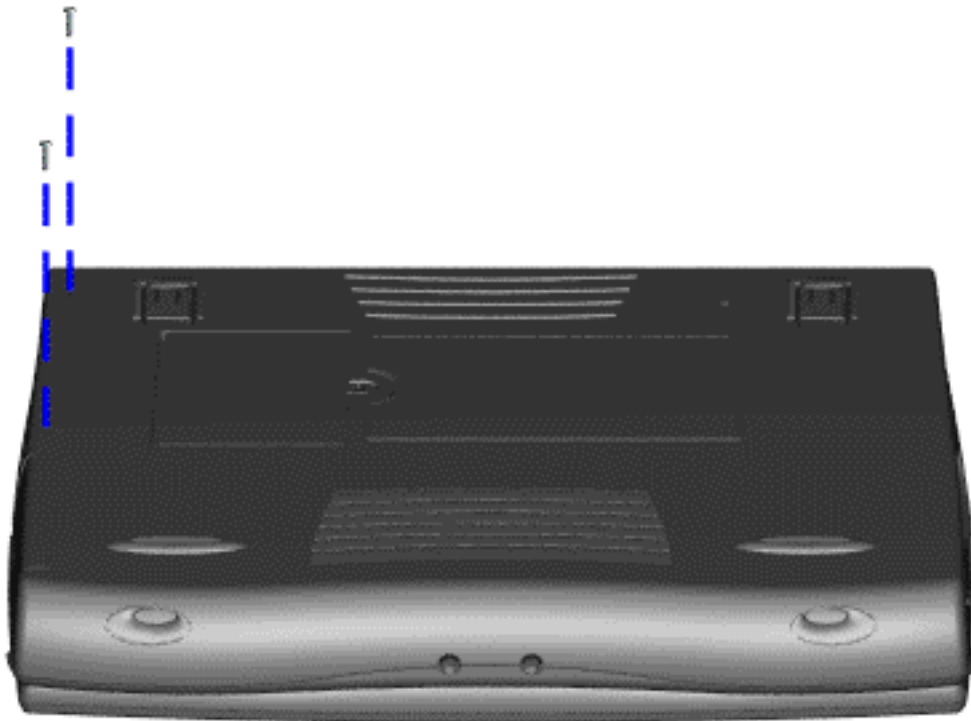

6. Remove two screws from the base enclosure which secure the DVD or CD drive to the chassis.

[Next Step](#)

MAINTENANCE & SERVICE GUIDE

for Prosignia 150 Series Computer

[Index Page](#)
[Product Description](#)

[Preface -or- Notice](#)
[Illustrated Parts Catalog](#)

[Specifications](#)
[Troubleshooting](#)

[Battery Pack](#)
[Removal & Replacement](#)

Removal & Replacement

CD or DVD Drive

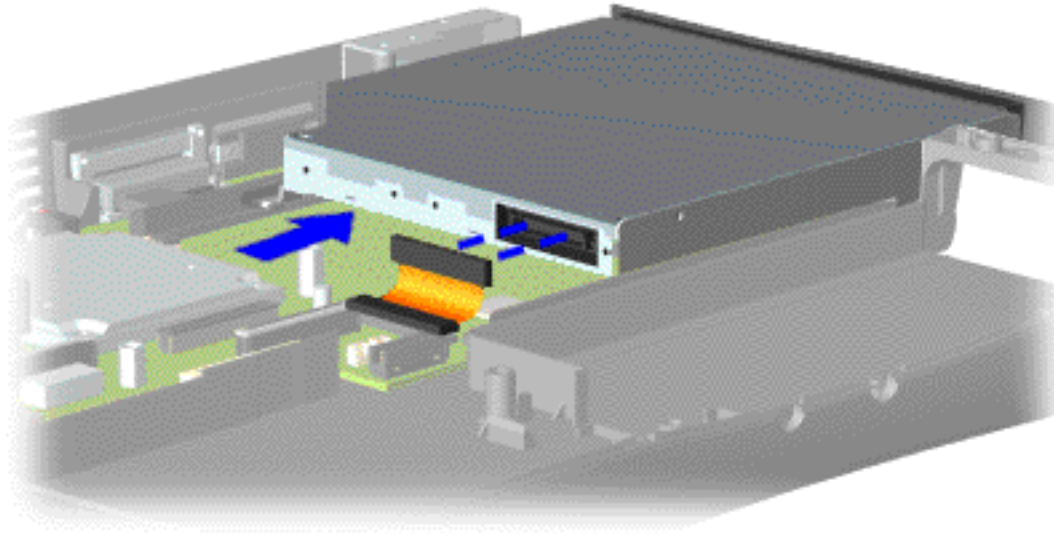

7. Disconnect the DVD or CD drive cable from the DVD or CD drive and remove the DVD or CD drive from the chassis.

To replace the DVD or CD drive, reverse the previous procedures.

Return to [Removal & Replacement Index Page](#).

MAINTENANCE & SERVICE GUIDE

for Prosignia 150 Series Computer

[Index Page](#)
[Product Description](#)

[Preface -or- Notice](#)
[Illustrated Parts Catalog](#)

[Specifications](#)
[Troubleshooting](#)

[Battery Pack](#)
[Removal & Replacement](#)

Removal & Replacement Hard Drive

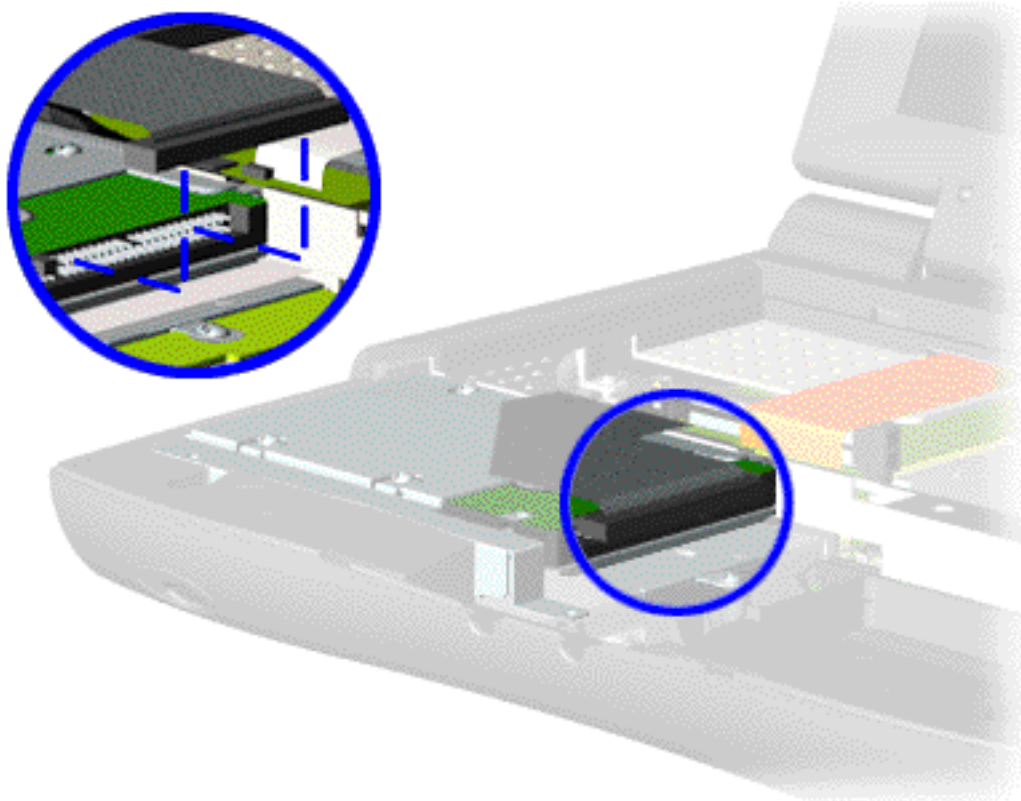

5. Disconnect the hard drive data cable from the hard drive and remove from the chassis.

[Next Step](#)

MAINTENANCE & SERVICE GUIDE

for Prosignia 150 Series Computer

[Index Page](#)
[Product Description](#)

[Preface -or- Notice](#)
[Illustrated Parts Catalog](#)

[Specifications](#)
[Troubleshooting](#)

[Battery Pack](#)
[Removal & Replacement](#)

Removal & Replacement Hard Drive

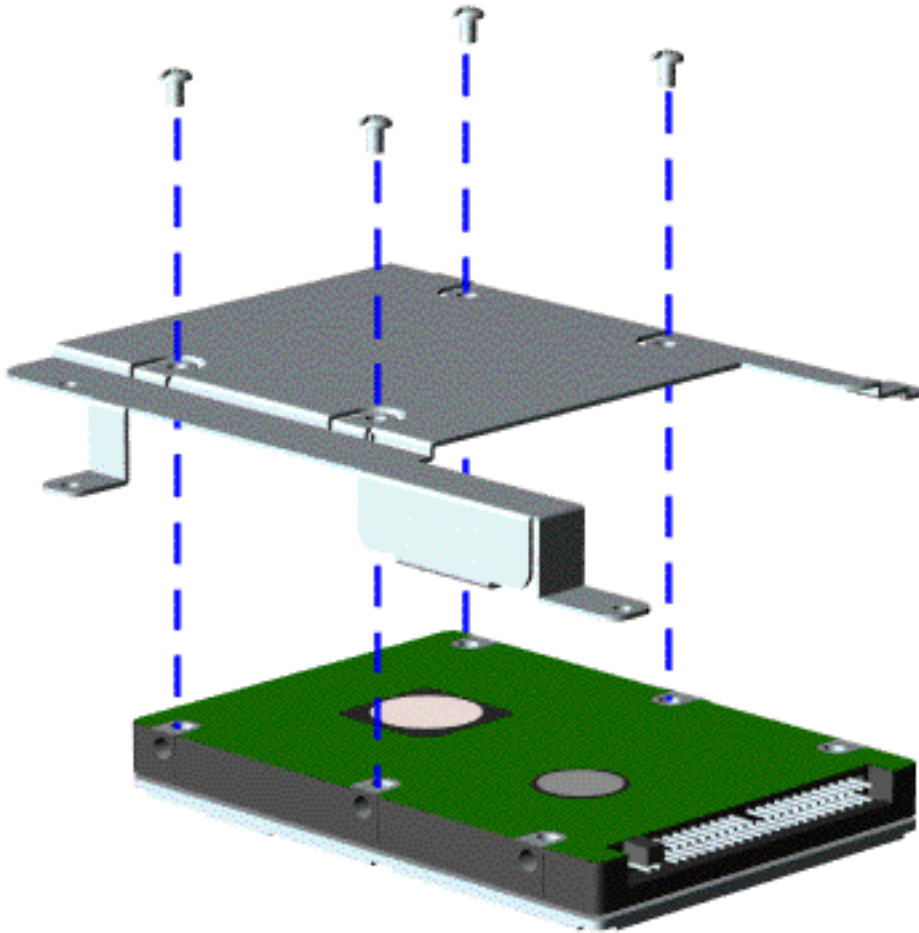

To remove the hard drive mounting bracket, complete the following step:

Remove the four screws from the hard drive mounting bracket and lift it off of the drive.

To replace the hard drive and hard drive mounting bracket, reverse the previous procedures.

Return to [Removal & Replacement Index Page](#).

MAINTENANCE & SERVICE GUIDE

for Prosignia 150 Series Computer

[Index Page](#)
[Product Description](#)

[Preface -or- Notice](#)
[Illustrated Parts Catalog](#)

[Specifications](#)
[Troubleshooting](#)

[Battery Pack](#)
[Removal & Replacement](#)

Removal & Replacement Processor

To replace the processor complete the following steps:

1. Insert the processor into the slot on the system board.

IMPORTANT: The notch on the upper left corner of the processor serves as an orientation indicator. Align the notch on the left corner of the processor with the notch on the left corner of the processor chassis slot.

NOTE: When installing the processor into the chassis slot, be sure that the hole pattern on the chassis slot lines up with the pins on the processor. The processor should drop into the socket without any force.

2. Insert a small blade screw driver into the top slot opening on the processor and push away from the display to lock the processor.

Return to [Removal & Replacement Index Page](#).

MAINTENANCE & SERVICE GUIDE

for Prosignia 150 Series Computer

[Index Page](#)
[Product Description](#)

[Preface -or- Notice](#)
[Illustrated Parts Catalog](#)

[Specifications](#)
[Troubleshooting](#)

[Battery Pack](#)
[Removal & Replacement](#)

Removal & Replacement Keyboard

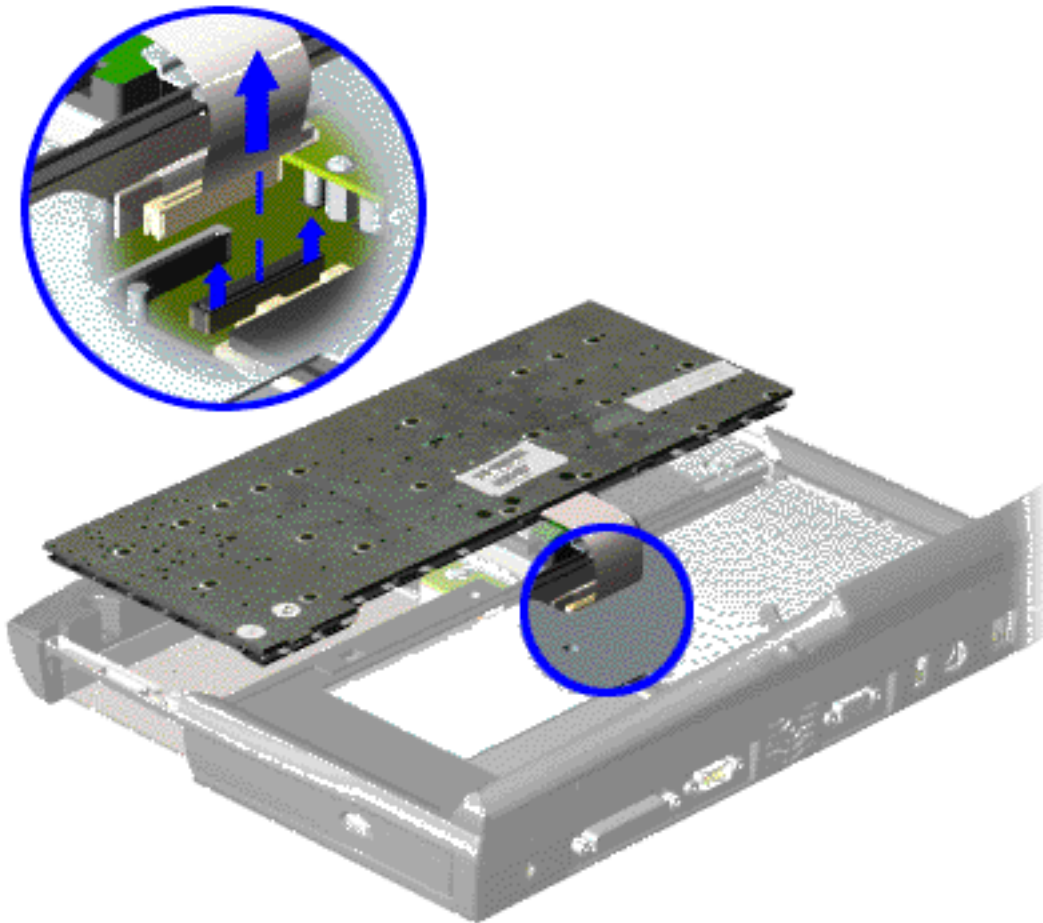

5. Disconnect the flex cable from the ZIF connector on the system board and remove the keyboard.

To replace the keyboard, reverse the previous procedures.

Return to [Removal & Replacement Index Page](#).

MAINTENANCE & SERVICE GUIDE

for Prosignia 150 Series Computer

[Index Page](#)
[Product Description](#)

[Preface -or- Notice](#)
[Illustrated Parts Catalog](#)

[Specifications](#)
[Troubleshooting](#)

[Battery Pack](#)
[Removal & Replacement](#)

Removal & Replacement

Touchpad Assembly

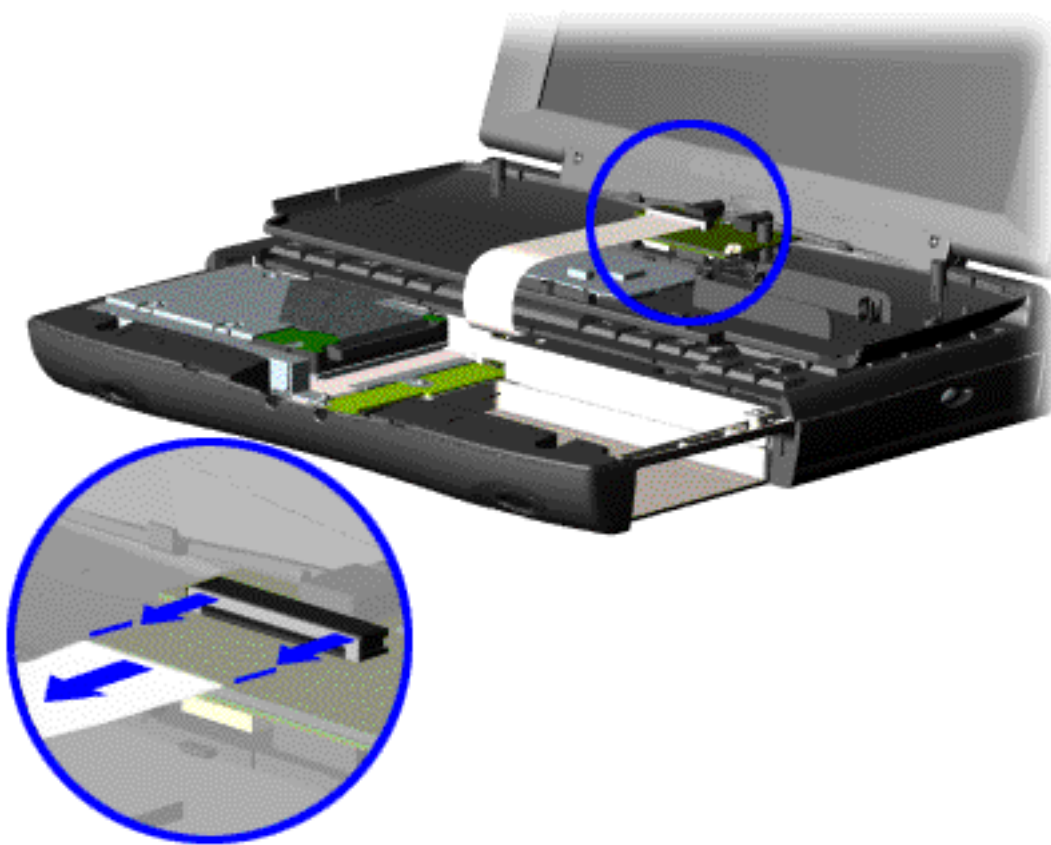

4. Turn the computer over (right side up), pull forward on the display latches to release and open the display assembly.

5. Lift up front end of the palmrest cover with touch pad and remove it from the groove in the chassis.

6. Tilt the palmrest cover with touch pad, allowing it to rest on top of the keyboard, and disconnect the flex cable from the LIF connector on the palmrest cover.

CAUTION: When replacing the palmrest cover with touch pad, ensure that the cable is fully inserted into the LIF connector on the system board. If the metal end comes in contact with the keyboard, it could damage the computer.



To replace the palmrest cover with touch pad, reverse the previous procedures.

NOTE: When replacing the palm rest cover, ensure that the cable is properly routed through the slot on the Upper CPU cover.

Return to [Removal & Replacement Index Page](#).

MAINTENANCE & SERVICE GUIDE

for Prosignia 150 Series Computer

[Index Page](#)
[Product Description](#)

[Preface -or- Notice](#)
[Illustrated Parts Catalog](#)

[Specifications](#)
[Troubleshooting](#)

[Battery Pack](#)
[Removal & Replacement](#)

Removal & Replacement Battery Pack

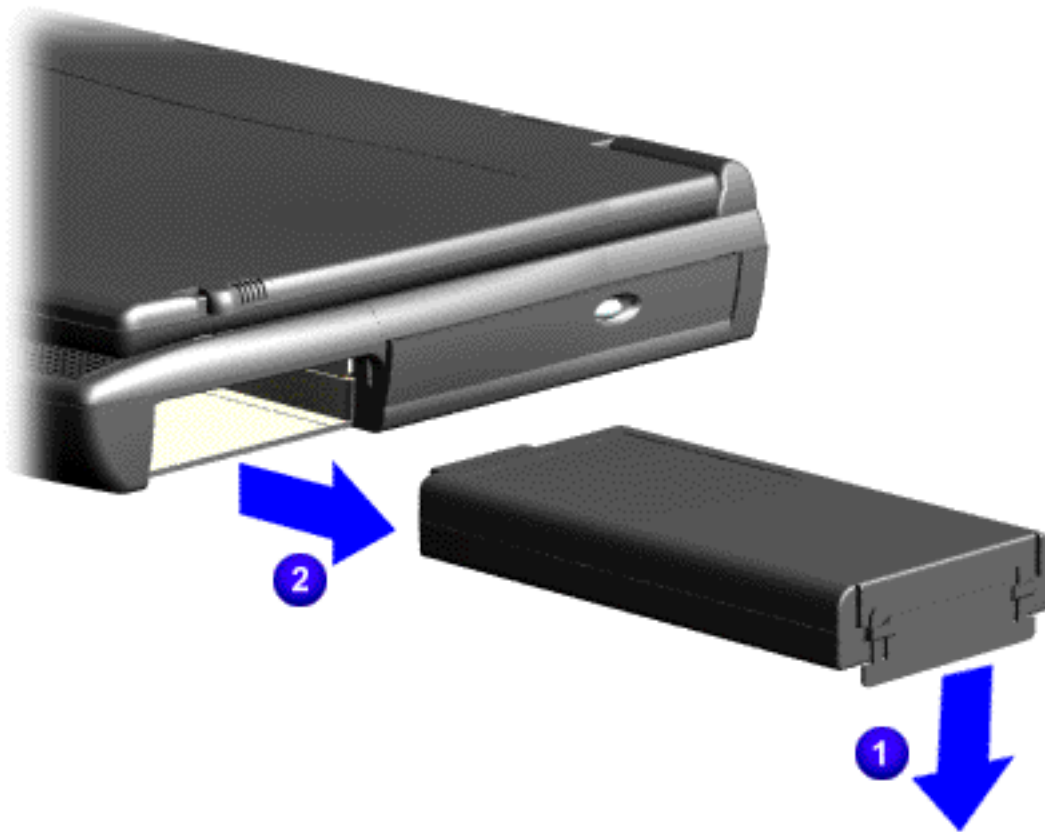

2. Pull down on the battery pack tab

1 and
2 pull the battery pack from the chassis.

To replace the battery pack, reverse the previous procedures.

Return to [Removal & Replacement Index Page](#).

MAINTENANCE & SERVICE GUIDE

for Prosignia 150 Series Computer

[Index Page](#)
[Product Description](#)

[Preface -or- Notice](#)
[Illustrated Parts Catalog](#)

[Specifications](#)
[Troubleshooting](#)

[Battery Pack](#)
[Removal & Replacement](#)

Troubleshooting

Preliminary Steps

*
> Preliminaries
> Clearing CMOS
> Power-on Self-test
> Compaq Diagnostics
> Diagnostic Error codes
> Test Utilities
> Solving Minor Problems
> Contacting Compaq
*

Before running [POST](#), complete the following preliminary steps:

1. If a power-on password has been established, type the password and press the Enter key. If the password is not known, [clear the password](#).
2. Run [Computer Checkup](#).
3. Turn off the computer and its external devices.
4. Disconnect any external devices that you do not want to test. Do not disconnect the printer if you want to test it or use it to log error messages.

IMPORTANT: If the problem only occurs when an external device is connected to the computer, the problem may be related to the external device or its cable. Verify this by running POST with and without the external device connected.

5. Install loopback plugs in the serial and parallel connectors if you would like to test these ports.
6. Ensure the hard drive is installed in the computer.
7. Ensure that the battery pack is inserted in the computer and the computer is connected to an external AC power source.

When the preliminary steps are completed, you are ready to run [POST](#).

MAINTENANCE & SERVICE GUIDE

for Prosignia 150 Series Computer

[Index Page](#)
[Product Description](#)

[Preface -or- Notice](#)
[Illustrated Parts Catalog](#)

[Specifications](#)
[Troubleshooting](#)

[Battery Pack](#)
[Removal & Replacement](#)

Troubleshooting

Clearing the Power-on Password

*
> Preliminaries
> Clearing CMOS
> Power-on Self-test
> Compaq Diagnostics
> Diagnostic Error codes
> Test Utilities
> Solving Minor Problems
> Contacting Compaq
*

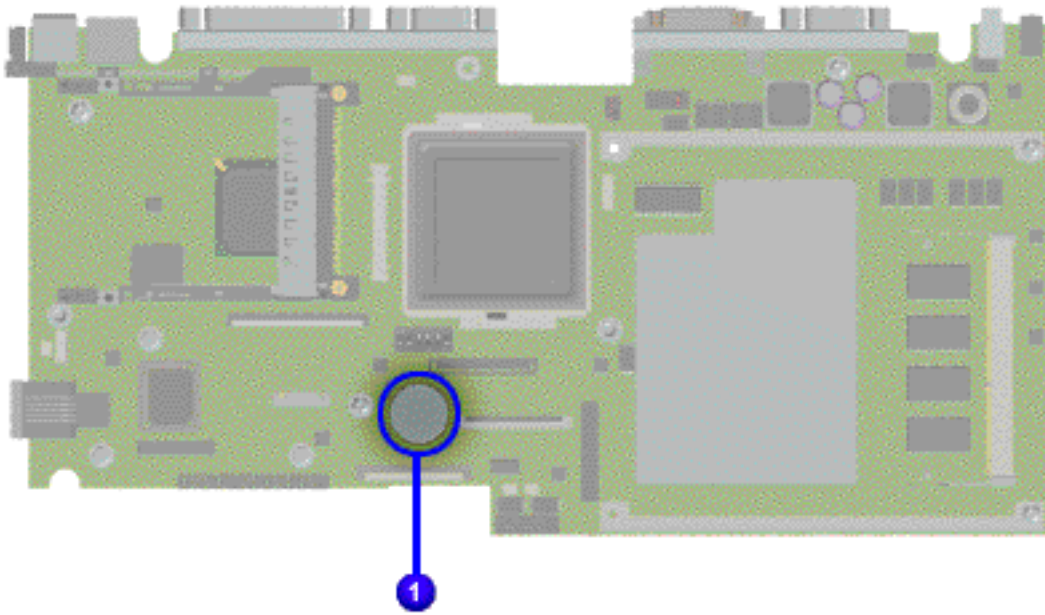

Clearing the power-on password requires removing all Setup attributes that are programmed in the CMOS.

The **1** RTC battery is located on the system board.

If the password is not known, clear it by performing the following steps:

1. Turn off the computer.
2. Disconnect the power cord.
3. Remove the [battery pack](#).
4. Remove the [Palmrest Cover with Touch Pad](#).
5. Remove the [heatspreader](#).
6. Remove the [keyboard](#).
7. Remove RTC battery for 30 seconds and replace it .
8. Reassemble the computer.
9. Turn on the computer to verify that the power-on password has been cleared. If it has not been cleared, repeat Steps 1 through 9.

MAINTENANCE & SERVICE GUIDE

for Prosignia 150 Series Computer

Troubleshooting

Power-on Self Test (POST)

*
> Preliminaries
> Clearing CMOS
> Power-on Self-test
> Compaq Diagnostics
> Diagnostic Error codes
> Test Utilities
> Solving Minor Problems
> Contacting Compaq
*

To run POST, complete the following steps:

1. Turn off the computer, then turn on the computer.
2. If POST does not detect any errors, the computer will not beep. This indicates successful completion of POST test. POST has run successfully and boots from the hard drive (or from a bootable diskette if one is installed in the diskette drive).
3. If POST detects errors, the errors are indicated by screen and/or audible messages. Refer to "Power-On Self-Test (POST) Codes" in the tables for a list of POST codes and their relevant descriptions.

NOTE: If the system is not functioning well enough to run POST, or if the display is not functioning well enough to show POST error messages, refer to the Troubleshooting tables.

Power-On Self-Test Messages	
102-System Board Failure	
Probable Cause	Recommended Action
DMA, timers, etc.	Replace the system board.
162-System Options Not Set	
Probable Cause	Recommended Action
Configuration incorrect	Run Computer Setup.
CMOS reflects that an invalid configuration has been set.	Run Computer Setup.
RAM failure	1. Replace the memory modules. 2. Replace the system board.
Memory test data error	1. Replace the memory modules. 2. Replace the system board.
XX000YZZ RAM failure	Replace the system board.

XX000YZZ 201-Memory Error	
Probable Cause	Recommended Action
301-Keyboard Error	
Probable Cause	Recommended Action
Keyboard failure	1. Ensure the keys are not depressed during POST. 2. Reconnect the keyboard with the computer off. 3. Replace the keyboard.
304-Keyboard or System Unit Error	
Probable Cause	Recommended Action
Keyboard or system board error	1. Replace the keyboard. 2. Replace the TouchPad or mouse. 3. Replace the system board.
601-Diskette Controller Error	
Probable Cause	Recommended Action
Mismatch in drive type or failure in the diskette controller	1. Run Computer Checkup (TEST). 2. Check and/or replace cables. 3. Replace the system board.
605-Diskette Drive Error	
Probable Cause	Recommended Action
Mismatch in drive type	Run Computer Setup.
1780-Primary Hard Drive 0 Failure	
Probable Cause	Recommended Action
Disk 0 failed to respond	1. Run Computer Checkup (TEST). 2. Replace the hard drive.
Hard drive format error	1. Run Computer Checkup (TEST). 2. Replace the hard drive.
1782-Hard Drive Controller	
Probable Cause	Recommended Action
Hard drive controller failure	1. Run Computer Setup. 2. Replace the hard drive.

MAINTENANCE & SERVICE GUIDE

for Prosignia 150 Series Computer

[Index Page](#)
[Product Description](#)

[Preface -or- Notice](#)
[Illustrated Parts Catalog](#)

[Specifications](#)
[Troubleshooting](#)

[Battery Pack](#)
[Removal & Replacement](#)

Troubleshooting

Compaq Diagnostics

*
> Preliminaries
> Clearing CMOS
> Power-on Self-test
> Compaq Diagnostics
> Diagnostic Error codes
> Test Utilities
> Solving Minor Problems
> Contacting Compaq
*

Compaq Diagnostics is installed on the hard drive of the computer. Run the Diagnostics utilities when you want to view or test system information and if you have installed or connected devices. If you run Compaq Diagnostics from a diskette, ensure that it is version 10.11 or later.

The Diagnostics menu includes the following utilities:

- [Computer Checkup \(TEST\)](#)
- [View System Information \(INSPECT\)](#)
- [Prepare Computer for a Compaq Service Call \(RemotePaq\)](#)

If you have a problem you cannot solve, run the Diagnostics utilities before you call for support. Run Computer Checkup and select to save the device list to a file and to print or to save the log of errors. Run the View System Information (INSPECT) utility and select to print or to save that information. Have the files or the printed information available when you call for support.

Computer Checkup (TEST)

Computer Checkup (TEST) determines whether the various computer components and devices are recognized by the system and are functioning properly. You can display, print, or save the information generated by Computer Checkup.

Follow these steps to run Computer Checkup:

1. Plug the computer into an external power source. (A low battery condition could interrupt the program.)
 2. Turn on the external devices that you want to test. Connect the printer if you want to print a log of error messages.
 3. Insert the Compaq Diagnostics diskette in drive A.
 4. Turn on or restart the computer. The computer starts from drive A, and the Diagnostics Welcome screen appears.
 5. Press Enter to continue. The Diagnostics menu appears.
 6. Select Computer Checkup from the Diagnostics menu. A Test Option menu appears.
 7. Select View the Device List from the Test Option menu. A list of the installed Compaq devices appears.
 8. If the list of installed devices is correct, select OK. The Test Option menu appears.
- NOTE: If the list is incorrect, ensure that any new devices are installed properly.
9. Select one of the following from the Test Option menu:
 - Quick Check Diagnostics. Runs a quick, general test on each device with a minimal number of prompts. If errors occur, they display when the testing is complete. You cannot print or save the error messages.
 - Automatic Diagnostics. Runs unattended, maximum testing of each device with minimal prompts. You can choose how many times to run the tests, to stop on errors, or to print or save a log of errors.
 - Prompted Diagnostics. Allows maximum control over testing the devices. You can choose attended or unattended testing, decide to stop on errors, or choose to print or save a log of errors.
 10. Follow the instructions on the screen as the devices are tested. When testing is complete, the Test Option menu appears.
 11. Exit the Test Option menu.
 12. Exit the Diagnostics menu.

View System Information (INSPECT)

The View System Information (INSPECT) utility provides information about the computer and installed or connected devices. You can display, print, or save the information.

Follow these steps to run View System Information (INSPECT) from the Compaq Diagnostics diskette:

1. Turn on the external devices that you want to test. Connect the printer if you want to print the information.
2. Insert the Compaq Diagnostics diskette in drive A.
3. Turn on or restart the computer. The computer starts from drive A, and the Diagnostics Welcome screen appears.
4. Press Enter to continue. The Diagnostics menu appears.
5. Select View System Information (INSPECT) from the Diagnostics menu.
6. Select the item you want to view from the following list:

System	Memory
ROM	Audio
Keyboard	Operating system
System ports	System files
System storage	Windows files
Graphics	
7. Follow the instructions on the screen to cycle through the screens, to return to the list and choose another item, or to print the information.

MAINTENANCE & SERVICE GUIDE

for Prosignia 150 Series Computer

[Index Page](#) [Preface -or- Notice](#) [Specifications](#) [Battery Pack](#)
[Product Description](#) [Illustrated Parts Catalog](#) [Troubleshooting](#) [Removal & Replacement](#)

Troubleshooting

Diagnostic Error Codes

*
> Preliminaries
> Clearing CMOS
> Power-on Self-test
> Compaq Diagnostics
> Diagnostic Error codes
> Test Utilities
> Solving Minor Problems
> Contacting Compaq
*

Diagnostic error codes occur if the system recognizes a problem while running the Compaq Diagnostic program. These error codes help identify possibly defective subassemblies.

The following tables list error codes, a description of the error condition, and the action required to resolve the error condition.

Retest the system after completing each step. If the
IMPORTANT: problem has been resolved, do not proceed with the remaining steps.

For the removal and replacement of a particular subassembly, see [Removal and Replacement Procedures](#).

Select error codes by number or type:

- | | | |
|-----------------------------------|--|--|
| 101 through 114 | Processor Test | |
| 200 through 215 | Memory Test | |
| 300 through 304 | Keyboard Test | |
| 401 through 403 | Parallel Printer Test | |
| 600 through 699 | Diskette Drive Test | |
| 1101 | Serial Test | |
| 1701 through 1736 | Hard Drive Test | |
| 501 through 516 | Video Test | |
| 2402 through 2456 | Audio Test | |
| 2458 through 2480 | Touch Pad Pointing Device Test | |
| 3206 | CD Test | |
| 8601 through 8602 | | |
| 3301 through 6623 | | |

Processor Test Error Codes			
Error Code	Description	Recommended Action	
101-xx	CPU test failed	Replace the processor and retest.	
102-xx	Coprocessor or Weitek Error	1. Run the Configuration and Diagnostics Utilities. 2. Replace the processor board and retest.	
103-xx	DMA page registers test failed	Replace the system board and retest.	
104-xx	Interrupt controller master test failed		
105-xx	Port 61 error		
106-xx	Keyboard controller self-test failed		
107-xx	CMOS RAM test failed		
108-xx	CMOS interrupt test failed		
109-xx	CMOS clock test failed		
110-xx	Programmable timer load data test failed		
113-xx	Protected mode test failed		
114-01	Speaker test failed		1. Check system configuration. 2. Verify cable connections to speaker. 3. Replace the system board and retest.
Memory Test Error Codes			
200-xx	Memory machine ID test failed	1. Flash the system ROM and retest. 2. Replace the system board and retest.	
202-xx	Memory system ROM checksum failed		
203-xx	Write/Read test failed	1. Remove the memory module and retest. 2. Install a new memory module and retest.	
204-xx	Address test failed		
211-xx	Random pattern test failed		
214-xx	Noise test failed		
215-xx	Random address test failed		
Keyboard Test Error Codes			
300-xx	Failed ID Test	1. Check the keyboard connection. If disconnected, turn off the computer and connect the keyboard. 2. Replace the keyboard and retest. 3. Replace the system board and retest.	
301-xx	Failed Selftest/Interface Test		
302-xx	Failed Individual Key Test		
304-xx	Failed Keyboard Repeat Test		
Parallel Printer Test Error Codes			
401-xx	Printer not connected	1. Connect the printer. 2. Check power to the printer. 3. Install the loop-back connector and retest. 4. Check port and IRQ configuration. 5. Replace the system board and retest.	
402-xx	Failed Port Test		
403-xx	Printer pattern test failed		
Diskette Drive Test			
600-xx	Diskette ID drive types test failed	1. Replace the diskette media and retest. 2. Check and/or replace the diskette power and signal cables and retest. 3. Replace the diskette drive and retest. 4. Replace the system board and retest.	
601-xx	Diskette format failed		
602-xx	Diskette read test failed		
603-xx	Diskette write, read, compare test failed		
604-xx	Diskette random read test failed		
605-xx	Diskette ID media failed		
606-xx	Diskette speed test failed		
609-xx	Diskette reset controller test failed		
610-xx	Diskette change line test failed		
697-xx	Diskette type error		
698-xx	Diskette drive speed not within limits		
699-xx	Diskette drive/media ID error		1. Replace media. 2. Run the Configuration and Diagnostics Utilities.
Serial Test Error Codes			
1101-xx	Serial port test failed		1. Check port configuration 2. Replace the system board and retest.
Hard Drive Test Error Codes			
1701-xx	Hard drive format test failed	1. Run the Configuration and Diagnostics Utilities and verify drive type. 2. Verify that all secondary drives have secondary drive capability. 3. Replace the hard drive and retest. 4. Replace the system board and retest.	
1702-xx	Hard drive read test failed		
1703-xx	Hard drive write/read/compare test failed		
1704-xx	Hard drive random seek test failed		
1705-xx	Hard drive controller test failed		
1706-xx	Hard drive ready test failed		
1707-xx	Hard drive recalibration test failed		
1708-xx	Hard drive format bad track test failed		
1709-xx	Hard drive reset controller test failed		
1710-xx	Hard drive park head test failed		
1715-xx	Hard drive head select test failed		
1716-xx	Hard drive conditional format test failed		
1717-xx	Hard drive ECC* test failed		
1719-xx	Hard drive power mode test failed		
1724-xx	Network preparation test failed		
1736-xx	Drive monitoring test failed		
* ECC = Error Correction Code			
Go back to the top			
Video Test Error Codes			
501-xx	Video controller test failed		The following apply to error codes 501-xx through 516-xx: 1. Disconnect external monitor and test with internal LCD display. 2. Replace the display assembly and retest. 3. Replace the system board and retest.
502-xx	Video memory test failed		
503-xx	Video attribute test failed		
504-xx	Video character set test failed		
505-xx	Video 80 x 25 mode 9 x 14 character cell test failed		
506-xx	Video 80 x 25 mode 8 x 8 character cell test failed		
507-xx	Video 40 x 25 mode test failed		
508-xx	Video 320 x 200 mode color set 0 test failed		
509-xx	Video 320 x 200 mode color set 1 test failed		
510-xx	Video 640 x 200 mode test failed		
511-xx	Video screen memory page test failed		
512-xx	Video gray scale test failed		
514-xx	Video white screen test failed		
516-xx	Video noise pattern test failed		
2402-xx	Video memory test failed	The following steps apply to error codes 2402-xx through 2456-xx: 1. Run the Configuration and Diagnostics Utilities. 2. Replace the display assembly and retest. 3. Replace the system board and retest.	
2403-xx	Video attribute test failed		
2404-xx	Video character set test failed		
2405-xx	Video 80 x 25 mode 9 x 14 character cell test failed		
2406-xx	Video 80 x 25 mode 8 x 8 character cell test failed		
2408-xx	Video 320 x 200 mode color set 0 test failed		
2409-xx	Video 320 x 200 mode color set 1 test failed		
2410-xx	Video 640 x 200 mode test failed		
2411-xx	Video screen memory page test failed		
2412-xx	Video gray scale test failed		
2414-xx	Video white screen test failed		
2416-xx	Video noise pattern test failed		
2418-xx	ECG/VGC memory test failed		
2419-xx	ECG/VGC ROM checksum test failed		1. Run the Configuration and Diagnostics Utilities. 2. Disconnect external monitor and test with internal LCD display. 3. Replace the display assembly and retest. 4. Replace the system board and retest.
2421-xx	ECG/VGC 640 x 200 graphics mode test failed		
2422-xx	ECG/VGC 640 x 350 16 color set test failed		
2423-xx	ECG/VGC 640 x 350 64 color set test failed		
2424-xx	ECG/VGC monochrome text mode test failed		
2425-xx	ECG/VGC monochrome graphics mode test failed		
2431-xx	640 x 480 graphics test failure		
2432-xx	320 x 200 graphics (256 color mode) test failure		
2448-xx	Advanced VGA Controller test failed		
2451-xx	132-column Advanced VGA test failed		
2456-xx	Advanced VGA Color test failed		
2458-xx	Advanced VGA BitBLT test	The following step applies to error codes 2458-xx through 2480-xx: Replace the system board and retest.	
2468-xx	Advanced VGA DAC test		
2477-xx	Advanced VGA data path test		
2478-xx	Advanced VGA BitBLT test		
2480-xx	Advanced VGA LineDraw test		
Audio Test Error Codes			
3206-xx	Audio System Internal Error	Replace the system board and retest.	
TouchPad/Pointing Device Interface Test Error Codes			
8601-xx	Mouse test failed	1. Replace the TouchPad and retest. 2. Replace the system board and retest.	
8602-xx	Interface test failed		
CD Drive Test Error Codes			
3301-xx	CD drive read test failed	1. Replace the CD and retest. 2. Verify that the speakers are connected. 3. Verify that drivers are loaded and properly installed. 4. Replace the CD drive and retest. 5. Replace the system board and retest.	
3305-xx	CD drive seek test failed		
6600-xx	ID test failed		
6605-xx	Read test failed		
6608-xx	Controller test failed		
6623-xx	Random read test failed		
Go back to the top			

MAINTENANCE & SERVICE GUIDE

for Prosignia 150 Series Computer

[Index Page](#)
[Product Description](#)

[Preface -or- Notice](#)
[Illustrated Parts Catalog](#)

[Specifications](#)
[Troubleshooting](#)

[Battery Pack](#)
[Removal & Replacement](#)

Troubleshooting

Without Diagnostics

This section provides information about how to identify and correct some common hardware, memory and software problems. It also explains several types of common messages that may be displayed on the screen.

The below listed items contain specific troubleshooting information regarding:

Audio	Memory
Battery/Battery gauge	PC Card
CD drive	Power
Diskette/Diskette drive	Printer
Display	Touch Pad
Hard drive	Keyboard/Numeric keypad
Hardware Installation	

Since symptoms can appear to be similar, carefully match the symptoms of the computer malfunction against the problem description in the Troubleshooting tables to avoid a misdiagnosis.



WARNING: To avoid a potential shock hazard during troubleshooting procedures, disconnect all power sources before removing the keyboard cover or the display bezel.

Before Replacing Parts

- Verify that cables are connected properly to the suspected defective parts.
- Run Computer Setup after connecting external devices.
- Verify that all required device drivers are installed.
- Verify that all required changes have been made to the CONFIG.SYS file.
- Verify that all required changes have been made to the AUTOEXEC.BAT file.
- Verify that all printer drivers have been installed for each application.

MAINTENANCE & SERVICE GUIDE

for Prosignia 150 Series Computer

[Index Page](#) [Preface -or- Notice](#) [Specifications](#) [Battery Pack](#)
[Product Description](#) [Illustrated Parts Catalog](#) [Troubleshooting](#) [Removal & Replacement](#)

Troubleshooting

Solving Minor Problems

Some minor problems and possible solutions are outlined in the following tables. If the problem appears related to a software application, check the documentation provided with the software.

Solving Audio Problems

Some common audio problems and solutions are listed in the following table:

Solving Audio Problems		
Problem	Probable Cause	Solution(s)
Computer does not beep after the Power-On Self-Test (POST).	This is typical; it indicates successful completion of the Power-On Self-Test (POST).	No action is required.

Solving Battery Pack and Battery Gauge Problems

Some common causes and solutions for battery pack problems are listed in the following table. The "Solving Power Problems" section in this chapter may also be applicable.

Solving Battery Pack and Battery Gauge Problems		
Problem	Probable Cause	Solution(s)
Computer won't turn on when battery pack is inserted and power cord is unplugged.	Battery pack is discharged.	Connect the computer to an external power source and charge the battery pack. Replace the battery pack with a fully charged battery pack.
		Check the battery connectors on the system board to verify they are evenly spaced and that they are not bent or broken.
Computer is beeping and battery LED icon is blinking.	Battery charge is low.	Immediately save any open file(s). Then do any one of the following: <ul style="list-style-type: none"> Connect the computer to an external power source to charge the battery pack. Turn off the computer or initiate Hibernation until you can find another power source or charge the battery pack.
Computer battery LED icon (front on the unit) blinks to indicate low battery condition, but computer does not beep.	Volume is turned down too low.	Adjust the volume.
Battery LED icon doesn't light and battery pack won't fast charge.	Battery pack is already charged.	No action is necessary.
	Battery pack was exposed to temperature extremes.	Allow time for the battery pack to return to room temperature.
	Battery pack is at end of its life.	Replace battery pack.
You have to set the date and time every time you turn on the computer.	RTC battery is dead.	Replace the RTC battery.

Problem	Probable Cause	Solution(s)
Battery charge does not last as long as expected.	Battery is being exposed to high temperatures or extremely cold temperatures.	Keep the battery pack within the recommended operating temperature range 50° F to 104° F (10° C to 40° C) or recommended storage range -4° F to 86° F (-20° C to 30° C). Recharge the battery pack.
	Battery has partially self-discharged.	Recharge the battery. Discharge the battery completely and then recharge it.
	Power management is disabled.	Set a power management level in Computer Setup.
	An external device or PC Card is draining the battery.	Turn off or disconnect external devices when not using them.
Battery pack is warm to the touch after charging.	Normal warming has occurred due to charging.	No action is required.
Battery pack operating time is far less than the documented average operating time.	Power management is turned off or disabled.	Enable power management in Computer Setup and in Windows Power Properties.
	An external device or PC Card is draining the battery.	Turn off or disconnect external devices when not using them.
	Battery pack has partially self-discharged.	Condition the battery pack by fully charging, fully discharging, then fully recharging it. To maintain the charge, leave battery packs in the computer when it is connected to external power. If the computer is disconnected from external power for more than two weeks, remove battery packs from the computer to reduce the discharge rate.
	Battery pack is being exposed to high temperatures or extremely cold temperatures.	Keep the battery pack within the recommended temperature ranges. Operating: 50° F to 104° F (10° C to 40° C) Storage: -4° F to 86° F (-20° C to 30° C) Recharge the battery pack.

Solving CD Drive Problems

Some common causes and solutions for CD drive problems are listed in the following table:

Solving CD Drive Problems		
Problem	Probable Cause	Solution(s)
CD drive cannot read a compact disc.	Compact disc is upside down or is improperly inserted in the CD drive.	Open the CD loading tray, lay the compact disc in it (label side up), then close the tray.
	CD is CD Plus or Pregap/Track 0 type.	Cannot read these type CDs in 24x. Remove the CD.

Solving Diskette and Diskette Drive Problems

Some common causes and solutions for diskette and diskette drive problems are listed in the following table.

Solving Diskette and Diskette Drive Problems		
Problem	Probable Cause	Solution(s)
Diskette drive cannot write to a diskette.	Diskette is write-protected.	Disable the diskette's write-protect feature or use a diskette that is not write-protected.
	Computer is writing to the wrong drive.	Check the drive letter in the path statement.
	Not enough space is left on the diskette.	Use another diskette.
	Drive error has occurred.	Run Computer Checkup from the Compaq Diagnostics diskette.
	Diskette is not formatted.	Format the diskette. At the system prompt, enter FORMAT A:
Diskette drive cannot read a diskette.	The wrong type of diskette is being used.	Use the type of diskette required by the drive.
	Diskette has a bad sector.	Copy files to hard drive or another diskette. Reformat bad floppy.
	Drive error has occurred.	Run Computer Checkup from the Compaq Diagnostics diskette.
	Diskette is not formatted.	Format the diskette. At the system prompt, enter FORMAT A:
Cannot boot from diskette.	Bootable diskette is not in drive A.	Put the bootable diskette in drive A.
	Diskette Boot has incorrect setting in Computer Setup.	Run Computer Setup and set diskette as first to boot.

Solving Display Problems

This section lists some common causes and solutions for computer display and external monitor problems.

You can perform a monitor self-test on an external VGA color or monochrome monitor by disconnecting the monitor from the computer. To do so, complete the following steps:

- Turn off the monitor.
- Turn off the computer.
- Disconnect the monitor signal cable from the computer.
- Turn on the monitor and allow it to warm up for one minute.

The display should be white. A narrow black border may also appear on the left and right sides of the display. Either of these displays indicates that the monitor is working properly.

Solving Display Problems		
Problem	Probable Cause	Solution(s)
Screen is dim.	Control for brightness or contrast (if applicable) is not set properly.	Adjust the Brightness of the display by using Fn + F7 (^) or Fn + F8 (-). Adjust the Contrast of the display by using Fn + F5 (^) or Fn + F6 (-).
	Computer screen is in direct light.	Tilt display or move computer.
Screen is blank.	Screen save was initiated by Power Management due to lack of user activity.	Press any key or touch the Touch Pad.
	Display has overheated.	If computer is in direct sunlight, move it and allow it to cool off.
Display is blank and the Suspend icon is flashing.	System is in Suspend mode.	Press any key or touch the Touch Pad.
Internal display is blank and the screen on an external monitor displays information.	Display function was switched to the external monitor.	Use Fn + F2 to switch between LCD or CRT.

Problem	Probable Cause	Solution(s)
Internal display flashes or has garbled characters when computer is connected to external monitor.	Using 1024 x 768 or higher resolution on external monitor and have toggled back to internal display, which supports up to 800 x 600.	Restart the computer.
The light tubes on the edge of the display panel do not light up at all and Power-On Self-Test (POST) completes when the unit is powered up.**	Improper backlight or display cable connections	Replace the display assembly.
	Defective inverter board.	Replace the display assembly.
	Defective display cable.	Replace the display assembly.
	Defective display panel.	Replace the display assembly.
	Defective system board.	Replace the system board.
The light tubes on the edge of the display panel do not light up at all and Power-On Self-Test (POST) does not complete when the unit is powered up.**	Defective system board.	Replace the system board.
Backlight (brightness) cannot be adjusted with Fn + F7 (^) or Fn + F8 (-).***	Improper display cable connections.	1. Reseat the display cable to the system board. 2. Replace the display assembly.
	Defective inverter board.	Replace the display assembly.
	Defective display cable.	Replace the display assembly.
	Defective system board.	Replace the system board.
Contrast cannot be adjusted with Fn + F5 (^) or Fn + F6 (-).	Improper display cable connections.	1. Reseat the display cable to the system board. 2. Replace the display assembly.
	Defective inverter board.	Replace the display assembly.
	Defective display cable.	Replace the display assembly.
	Defective system board.	Replace the system board.

** This problem indicates that the backlight or its power circuitry has failed. Since you cannot observe the POST result on the display panel when the backlight is not functioning, connect the unit to an external monitor before powering the unit up. If an external monitor is not available, verify that POST completes by opening and closing the display, listening for the single or double beep, and watching for the LEDs turn on at the front of the computer.

Problem	Probable Cause	Solution(s)
This display panel has a continuous pattern across it (e.g., a "jailbars" pattern), has a single color on it, or has garbled graphics across the entire panel. This failure is for patterns across the entire panel (not just on one section).	Improper display cable connections	Reseat the display cable to the following until the problem is solved: 1. System board 2. Display assembly
	Defective display cable.	Replace the display assembly.
	Defective inverter board.	Replace the display assembly.
	Defective system board.	Replace the system board.
Ghost bars extending from graphics on the display.	Common characteristic of STN displays.	1. Change the background colors. 2. Adjust the Contrast of the display by using Fn + F5 (^) or Fn + F6 (-).
A single line, small group of lines, or block appears on the display panel. This failure occurs in only a section of the display panel.	Defective display panel.	Replace the display assembly.

To perform a "self-test" on an external VGA color or monochrome monitor, complete the following steps: The screen NOTE: should be white. A narrow black border may also appear on the left and right sides of the display. Either of these displays indicates that the monitor is working properly.

Solving Hard Drive Problems

Some common causes and solutions for hard drive problems are listed in the following table:

	CAUTION: To prevent loss of information, always maintain an up-to-date backup of your hard drive at all times, in the event of errors or failures.
---	---

Solving Hard Drive Problems		
Problem	Probable Cause	Solution(s)
Reading hard drive takes an unusually long time after restarting the computer.	System entered Hibernation due to low battery condition and is now exiting from it.	Give the system time to restore the previously saved data to its exact state before Hibernation.
Hard drive error occurs.	Hard drive has bad sectors or has failed.	Run Computer Checkup.
Hard drive does not work.	Hard drive is not installed properly.	Turn off and unplug the computer, remove the battery pack, and remove and then reinstall the hard drive.

Solving Hardware Installation Problems

Some common causes and solutions for hardware installation problems are listed in the following table.

Solving Hardware Installation Problems		
Problem	Probable Cause	Solutions(s)
A new device is not recognized as part of the computer system.	Cable(s) of new external device are loose or power cables are unplugged.	Ensure that all cables are properly and securely connected.
	Power switch of new external device is not turned on.	Turn off the computer, turn on the external device, then turn on the computer to integrate the device with the computer system.
	Device is not seated properly.	Turn off the computer and reinsert the device.

Solving Keyboard/Numeric Keypad Problems

Some common causes and solutions for keyboard/numeric keypad problems are listed in the following table.

Solving Keyboard/Numeric Keypad Problems		
Problem	Probable Cause	Solution(s)
Embedded numeric keypad on computer keyboard is disabled.	Num Lock function is not enabled.	Press the Shift+NumLk keys to enable the Num Lock function and embedded numeric keypad. The Num Lock icon on the status panel turns on.
Embedded numeric keypad is disabled and Num Lock function is on.	External numeric keypad is connected to the computer.	Disconnect the external numeric keypad from the computer.

Solving Memory Problems

Some common causes and solutions for memory problems are listed in the following table.

Solving Memory Problems		
Problem	Probable Cause	Solution(s)
Memory count during Power-On Self-Test (POST) is incorrect.	Optional memory expansion card is installed incorrectly, is incompatible with the computer, or is defective.	Ensure that the optional memory expansion card is installed correctly.
"Out of Memory" message is displayed on the screen or insufficient memory error occurs during operation.	System ran out of memory for the application.	Check the application documentation for the memory requirements. Install additional memory.
	Too many TSR (terminate-and-stay-resident) applications are running.	Remove from memory any non TSR applications that you do not need.

[Solving Minor Problems \(continued\)](#)

MAINTENANCE & SERVICE GUIDE

for Prosignia 150 Series Computer

[Index Page](#) [Preface -or- Notice](#) [Specifications](#) [Battery Pack](#)
[Product Description](#) [Illustrated Parts Catalog](#) [Troubleshooting](#) [Removal & Replacement](#)

Troubleshooting Solving PC Card Problems

Listed in the following tables are some common causes and solutions for PC Card problems:

Solving PC Card Problems		
Problem	Probable Cause	Solution(s)
When turned on, the computer does not beep when a PC Card is inserted.	Card is not inserted properly.	Ensure the card is inserted in the correct orientation.
	PC Card beeps are disabled.	Double-click the PC Card icon in the Control Panel, click the Global Settings tab, the enable PC Card sound effects.
	Speaker is turned off or volume is turned down.	Press volume buttons to turn the speaker on, then increase the volume.
	PC Card drivers are not installed.	Double click the Add New Hardware icon in the Control Panel for installation instructions. If PC Card or drivers are not compatible with Windows, install drivers and use the PC Card in MS-DOS mode.
PC Card modem, fax, or network card does not work.	Card or card driver is not supported.	Contact your Compaq authorized service provider for a list of PC Cards tested successfully in Compaq PC Card platforms.
	Card is not fully inserted into the slot or is not inserted properly.	Ensure the card is inserted in the correct orientation.
	Telephone cord is not plugged in all the way.	Check and secure telephone connection.
PC Card modem or fax card does not work.	Necessary drivers are not installed (turned on).	Install drivers.
	You are trying to access the card using the wrong COM port.	See Specifications to verify COM port.
	The card conflicts with a serial device.	See Specifications to verify address.
	The card is not supported.	Use supported cards only.

Modem network PC Card does not work.	Network driver is not installed or is not set up properly.	Install driver.
	Telephone cord is not properly connected.	Verify telephone connection.
Memory or storage card does not work.	SRAM and flash memory cards require the memory card driver to be loaded (turned on).	Install driver.
	Flash memory cards require the Microsoft FlashFile System to be loaded.	
	Hard drives on flash mass storage cards require the PC Card ATA driver to be loaded.	
	You are trying to access the hard drive card using the wrong drive letter.	Double-click My Computer to verify the drive letter assigned to the card.
	The card is not supported.	Contact your Compaq authorized service provider for a list of PC Cards tested successfully in Compaq PC Card platforms.

Solving Power Problems

Also see "Solving Battery and Battery Gauge Problems" in this section.

Solving Power Problems		
Problem	Probable Cause	Solution(s)
Computer won't turn on and battery pack is not inserted.	Computer is not connected to a power source.	Insert battery or connect an external power source.
	Power cords to the external power source are unplugged.	Ensure that power cords connecting the computer and the external power source are plugged in properly.
Computer turned off while it was left unattended and the power icon is off.	Power adapter is defective.	Replace AC Adapter and restart.
	System board is defective.	Replace the system board.
	System initiated Hibernation due to a critical low-battery condition.	Replace the battery pack with a fully charged battery pack or connect the computer to an external power source. Then turn on the computer.
	System initiated Hibernation after a preset timeout.	Turn on the computer.

Solving Printer Problems

If you experience problems printing, run a printer self-test. Refer to the documentation provided with your printer for instructions.

If the self-test fails, it is a printer-specific problem. Also refer to the printing section of your application documentation.

Solving Printer Problems		
Problem	Probable Cause	Solution(s)
Printer will not turn on.	The signal cable may not be connected properly, or the printer is unplugged.	Ensure that the signal cable is properly connected and that the power cord is connected to the electrical outlet.
Printer will not print.	Printer is not turned on or is off line.	Turn the printer on and set it to on line.
	The device drivers for your application are not installed.	Refer to the printer documentation to install the correct printer driver.
	Printer that is set up for a network is not connected to the network.	Connect the printer to the network.
	Printer cable is too long, unshielded, or defective.	Replace the cable.
Printer prints garbled information.	Paper tray is empty.	Fill the paper tray with paper and set the printer to online.
	Correct printer drivers are not installed.	Refer to the printer documentation to install the correct printer driver.
	Cable is not connected properly.	Ensure that the printer signal cable is properly connected to the computer.
	Cable is defective.	Replace the printer cable and retest.

Solving Touch Pad/Pointing Device Problems

Some common causes and solutions for Touch Pad/pointing device problems are listed in the following table.

Solving Touch Pad/Pointing Device Problems		
Problem	Cause	Solution(s)
Touch Pad or mouse does not work.	Incorrect or no device driver is installed.	Install the device driver and add to the AUTOEXEC.BAT file or CONFIG.SYS file.
	The device driver is not installed in Windows.	Install the Touch Pad/mouse driver in Windows.
External mouse does not work.	Mouse is not securely connected or is connected to an incorrect external connector.	Ensure that the mouse is securely connected to the appropriate external connector.
Touch Pad or mouse does not work even though the device is enabled in Windows.	Mouse is not enabled.	Enter MOUSE at the system prompt to activate the mouse device driver.
		Add a line in the AUTOEXEC.BAT file to automatically activate the mouse device driver each time computer is turned on or restarted.
	Cable not properly seated in Touch Pad board.	Reseat cable.
	Defective Touch Pad board.	Replace Touch Pad board.
	Defective system board.	Replace system board.
	Device driver is not correctly installed in Windows.	Install the appropriate device driver in Windows.
Cursor skips or moves abnormally when using the Touch Pad.	The Touch Pad needs to be cleaned.	Clean the Touch Pad with a cloth dampened with alcohol or an ammonia-based glass cleaner. Wipe up liquid with a dry cloth.

MAINTENANCE & SERVICE GUIDE

for Prosignia 150 Series Computer

[Index Page](#)
[Product Description](#)

[Preface -or- Notice](#)
[Illustrated Parts Catalog](#)

[Specifications](#)
[Troubleshooting](#)

[Battery Pack](#)
[Removal & Replacement](#)

Specifications

System Unit

*	Computer Specifications	
>System Unit	US	Metric
>System Interrupts		
>System DMA	Dimensions	
>System I/O	Height	1.97 in
>System Memory	Depth	12.32 in
>Display	Width	10.12 in
>Memory Expansion		5.0 cm
>Battery Pack		31.3 cm
>Diskette Drive		25.7 cm
>Hard Drives	Weight	
>CD/DVD Drives	14.1" TFT	7.99 lbs
>Modem	12.1" TFT	7.35 lbs
>AC Adapter	Stand-alone Power Requirements	
>Pin Assignments	Nominal Operating Voltage (Li Ion)	14.8 VDC
*	Maximum Operating Power	56.5 W
	Peak Operating Power	58.5 W
	AC Power Requirements	
	Operating Voltage	100-240 V
	Operating Current	0.8/0.4 A RMS
	Operating Frequency	47-63 Hz
	Maximum Transient	Meets IEC 801-4 and IEC801-5 1kV for 50 ns
	Temperature	
	Operating	41° to 95 °F
	Non-operating	-4° to 140 °F
		5° to 35 °C
		-20° to 60 °C
	Relative Humidity (Non-condensing)	
	Operating	10 to 90%
	Non-operating (tw = 38.7°C max)	5 to 95%
	Maximum Altitude (un-presurized)	
	Operating	10,000 ft
	Non-operating	30,000 ft
		3.15 km
		10.14 km
	Shock	
	Operating	10 G, 11 ms, half sine
	Non operating	240 G, 2 ms, half sine
	Vibration	
	Operating	0.55 G, 0.25 Oct / Min sweep rate
	Non-operating	1.5 G, 0.5 Oct / Min sweep rate
	<p>NOTE: Applicable product safety standards specify thermal limits for plastic surfaces. Compaq Prosignia Series Portable Computers operate well within this range of temperatures.</p>	

MAINTENANCE & SERVICE GUIDE

for Prosignia 150 Series Computer

[Index Page](#)
[Product Description](#)

[Preface -or- Notice](#)
[Illustrated Parts Catalog](#)

[Specifications](#)
[Troubleshooting](#)

[Battery Pack](#)
[Removal & Replacement](#)

Specifications

System Interrupts

*	Hardware IRQ	System Function
> System Unit	IRQ 0	System timer
> System Interrupts	IRQ1	Standard 101/102-Key or Microsoft Natural Keyboard
> System DMA	IRQ2	Programmable interrupt controller
> System I/O	IRQ3	(free)
> System Memory	IRQ4	Communications Port (COM1)
> Display	IRQ5	ALi PCI to USB Open Host Controller
> Memory Expansion	IRQ5	ESS SOLO-1 PCI AudioDrive
> Battery Pack	IRQ5	IRQ Holder for PCI Steering
> Diskette Drive	IRQ5	IRQ Holder for PCI Steering
> Hard Drives	IRQ6	Standard Floppy Disk Controller
> CD/DVD Drives	IRQ7	Printer Port (LPT1)
> Modem	IRQ8	System CMOS/real time clock
> AC Adapter	IRQ9	RAGE LT PRO AGP 2X (English)
> Pin Assignments	IRQ9	IRQ Holder for PCI Steering
*	IRQ10	Lucent 56K V.90 PCI DF Modem
	IRQ10	Generic CardBus Controller
	IRQ10	IRQ Holder for PCI Steering
	IRQ11	(free)
	IRQ12	Synaptics PS/2 TouchPad
	IRQ13	Numeric data processor
	IRQ14	Primary IDE controller (dual fifo)
	IRQ14	ALi M5229 PCI Bus Master IDE Controller
	IRQ15	Secondary IDE controller (dual fifo)
	IRQ15	ALi M5229 PCI Bus Master IDE Controller

MAINTENANCE & SERVICE GUIDE

for Prosignia 150 Series Computer

[Index Page](#)
[Product Description](#)

[Preface -or- Notice](#)
[Illustrated Parts Catalog](#)

[Specifications](#)
[Troubleshooting](#)

[Battery Pack](#)
[Removal & Replacement](#)

Specifications

System DMA

*	Hardware DMA	System Function
> System Unit	0	(free)
> System Interrupts	1	ESS SOLO-1 DOS Emulation
> System DMA	2	Standard Floppy Disk Controller
> System I/O	3	(free)
> System Memory	4	Direct memory access controller
> Display	5	(free)
> Memory Expansion	6	(free)
> Battery Pack	7	(free)
> Diskette Drive		
> Hard Drives		
> CD/DVD Drives		
> Modem		
> AC Adapter		
> Pin Assignments		
*		

Revised: September 16, 1999

MAINTENANCE & SERVICE GUIDE

for Prosignia 150 Series Computer

[Index Page](#)
[Product Description](#)

[Preface - or- Notice](#)
[Illustrated Parts Catalog](#)

[Specifications](#)
[Troubleshooting](#)

[Battery Pack](#)
[Removal & Replacement](#)

Specifications

System Memory Catalog

*	Memory Address	System Function
> System Unit	x00000000 - x0009FFFF	System board extension for PnP BIOS
> System Interrupts	x000A0000 - x000AFFFF	RAGE LT PRO AGP 2X (English)
> System DMA	x000B0000 - x000BFFFF	RAGE LT PRO AGP 2X (English)
> System I/O	x000C0000 - x000CBFFF	RAGE LT PRO AGP 2X (English)
> System Memory	x000E0000 - x000FFFFFF	System board extension for PnP BIOS
> Display	x00100000 - x03FFFFFF	System board extension for PnP BIOS
> Memory Expansion	x04000000 - x04000FFF	Generic CardBus Controller
> Battery Pack	xE0000000 - xE3FFFFFF	ALi M1541 AGP System Controller
> Diskette Drive	xFD000000 - xFDFFFFFF	RAGE LT PRO AGP 2X (English)
> Hard Drives	xFD000000 - xFECFFFFFF	PCI standard PCI-to-PCI bridge
> CD/DVD Drives	xFE000000 - xFE01FFFF	RAGE LT PRO AGP 2X (English)
> Modem	xFECFF000 - xFECFFFFFF	RAGE LT PRO AGP 2X (English)
> AC Adapter	xFEDFE000 - xFEDFEFFF	ALi PCI to USB Open Host Controller
> Pin Assignments	xFEDFFC00 - xFEDFFCFF	Lucent 56K V.90 PCI DF Modem
*	xFFFC0000 - xFFFFFFFF	Motherboard resources

MAINTENANCE & SERVICE GUIDE

for Prosignia 150 Series Computer

[Index Page](#)
[Product Description](#)

[Preface -or- Notice](#)
[Illustrated Parts Catalog](#)

[Specifications](#)
[Troubleshooting](#)

[Battery Pack](#)
[Removal & Replacement](#)

Specifications

Display

*	12.1" Fast Response Color STN SVGA TFT Display	
> System Unit	U.S.	Metric
> System Interrupts	Dimensions: Height Width	
> System DMA		
> System I/O	7.83"	19.9 cm
> System Memory	10.8"	25.7 cm
> Display	Diagonal Size	
> Memory Expansion	12.1 "	30.7 cm
> Battery Pack	Mounting	
> Diskette Drive	internal	
> Hard Drives	Number of Colors	
> CD/DVD Drives	16 M	
> Modem	Contrast Ratio	
> AC Adapter	Typical 150:1	
> Pin Assignments	Brightness	
*	Over 120 cd/m~3	
Pixel Resolution:		
Pitch Format Configuration		
0.30 x 0.30 mm 800 x 600 RGB Stripe		
Backlight		
Edge Light		
Character Display		
80 x 25, 80 x 50		
Total Power Consumption		
5.4 W (max)		

14.1" Color TFT 1024 x 768 Display		
	U.S.	Metric
Dimensions: Height Width		
	11.2 "	28.56 cm
Diagonal Size		
	14.1 "	35.8 cm
Mounting		
internal		
Number of Colors		
64 K		
Contrast Ratio		
Typical 150:1		
Brightness		
Over 120 cd/m~3		
Pixel Resolution:		
Pitch Format Configuration		
0.279 x 0.279 mm 1024 x 768 RGB Stripe		
Backlight		
Edge Light		
Character Display		
80 x 25		
Total Power Consumption		
6.6 W (max)		

MAINTENANCE & SERVICE GUIDE

for Prosignia 150 Series Computer

[Index Page](#)
[Product Description](#)

[Preface -or- Notice](#)
[Illustrated Parts Catalog](#)

[Specifications](#)
[Troubleshooting](#)

[Battery Pack](#)
[Removal & Replacement](#)

Specifications

Memory Expansion

*	Memory Expansion for 32-MB Memory on System Board		
> System Unit			
> System Interrupts			
> System DMA			
> System I/O			
> System Memory	System Board Memory (standard)	With Optional Expansion Memory	Total Memory
> Display	32-MB	32-MB	64-MB
> Memory Expansion	32-MB	64-MB	96-MB
> Battery Pack	32-MB	128-MB	160-MB
> Diskette Drive	Memory Expansion for 64-MB Memory on System Board		
> Hard Drives			
> CD/DVD Drives	System Board Memory (standard)	With Optional Expansion Memory	Total Memory
> Modem	64-MB	32-MB	96-MB
> AC Adapter	64-MB	64-MB	128-MB
> Pin Assignments	64-MB	128-MB	192-MB
*			

MAINTENANCE & SERVICE GUIDE

for Prosignia 150 Series Computer

[Index Page](#)
[Product Description](#)

[Preface -or- Notice](#)
[Illustrated Parts Catalog](#)

[Specifications](#)
[Troubleshooting](#)

[Battery Pack](#)
[Removal & Replacement](#)

Specifications

Li Ion Battery Pack

*		US	Metric
> System Unit			
> System Interrupts	Dimensions		
> System DMA	Height	.81"	2.05 cm
> System I/O	Length	3.05"	7.75 cm
> System Memory	Width	5.69"	14.45 cm
> Display			
> Memory Expansion	Weight	.85 lb	.39 kg
> Battery Pack			
> Diskette Drive	Energy		
> Hard Drives	Voltage	14.8 V	
> CD/DVD Drives	Amp-hour capacity	3.0 Ah	
> Modem	Watt-hour capacity	44.4 Wh	
> AC Adapter	Temperature		
> Pin Assignments	Operating	32 to 113 F	0 to 45 C
*	Non-operating	-4 to 140 F	-20 to 60 C

Revised: September 16, 1999

MAINTENANCE & SERVICE GUIDE

for Prosignia 150 Series Computer

[Index Page](#)
[Product Description](#)

[Preface -or- Notice](#)
[Illustrated Parts Catalog](#)

[Specifications](#)
[Troubleshooting](#)

[Battery Pack](#)
[Removal & Replacement](#)

Specifications

Diskette Drive

*		
> System Unit	Diskette Size	3.5"
> System Interrupts	Light	none
> System DMA	Height	.5" / 1.27 cm
> System I/O	Bytes per Sector	
> System Memory	Sectors per Track	512
> Display	High density	18 (1.44 MB) /
> Memory Expansion	Low density	15 (1.2 MB)
> Battery Pack		9
> Diskette Drive	Tracks per side	
> Hard Drives	High Density	80 (1.44 MB) /
> CD/DVD Drives	Low Density	80 (1.2 MB)
> Modem		80
> AC Adapter	Access Times	
> Pin Assignments	Track-to-Track (high/low)	3 ms/6 ms
	Average (ms)	94 ms/174ms
	Settling Time (ms)	15 ms
	Latency Average	100
	Number of Read/Write Heads	2
*		

MAINTENANCE & SERVICE GUIDE

for Prosignia 150 Series Computer

[Index Page](#) [Preface -or- Notice](#) [Specifications](#) [Battery Pack](#)
[Product Description](#) [Illustrated Parts Catalog](#) [Troubleshooting](#) [Removal & Replacement](#)

Specifications

Hard Drives

*	4.0 GB Hard Drive	
> System Unit	Capacity	4.3 GB
> System Interrupts	Type	65
> System DMA	Transfer Rate	
> System I/O	Media Interface	60.8 to 107.2 Mb/s 33.3 MB/s
> System Memory	Sector Interleave	1 : 1
> Display	Seek Time	2.5 ms
> Memory Expansion	Track-to-track	13 ms (read)
> Battery Pack	Average Maximum	23 ms
> Diskette Drive	Rotational Speed	4200 rpm
> Hard Drives	(typical reads including setting)	
> CD/DVD Drives	Physical Configuration	
> Modem	Cylinders	8647
> AC Adapter	Heads	6
> Pin Assignments	Sectors per track	240-250
*	Bytes per sector	512
	Logical Configuration	
	Cylinders	7944
	Heads	15
	Sectors per Track	63
	Bytes per sector	512
	Buffer Size	512 KB

6.4 GB Hard Drive	
Capacity	6.4 GB
Type	65
Transfer Rate:	
Media Interface	60.8 to 107.2 Mb/s 33.3 MB/s
Sector Interleave	1 : 1
Seek Time	2.5 ms
Track-to-track	13 ms (read)
Average Maximum	23 ms
Rotational Speed	4200 rpm
(typical reads including setting)	
Physical Configuration	
Cylinders	8647
Heads	6
Sectors per track	240-250
Bytes per sector	512
Logical Configuration	
Cylinders	13424
Heads	15
Sectors per Track	63
Bytes per sector	512
Buffer Size	512 KB

10 GB Hard Drive	
Capacity	10 GB
Type	65
Transfer Rate:	
Media Interface	69 to 118 Mb/s 16.6 MB/s
Sector Interleave	1 : 1
Seek Time	4 ms
Track-to-track	12 ms (read)
Average Maximum	23 ms
Rotational Speed	4200 rpm
(typical reads including setting)	
Physical Configuration	
Cylinders	11,968
Heads	6
Sectors per track	190-330
Bytes per sector	512
Logical Configuration	
Cylinders	16,383
Heads	15
Sectors per Track	63
Bytes per sector	512
Buffer Size	420 KB

MAINTENANCE & SERVICE GUIDE

for Prosignia 150 Series Computer

[Index Page](#)
[Product Description](#)

[Preface -or- Notice](#)
[Illustrated Parts Catalog](#)

[Specifications](#)
[Troubleshooting](#)

[Battery Pack](#)
[Removal & Replacement](#)

Specifications

CD/DVD Drives

*	24X Max CD-ROM Drive	
>System Unit	Applicable Disk	CD-DA, CD-ROM, CD-ROM XA, CD-1, Photo CD (multisession), Video CD, CD-R, CD-Extra (CD+), CD-G, CD-RW
>System Interrupts		
>System DMA	Center Hole Diameter	.6" / 15mm
>System I/O	Disc Diameter	12cm, 8cm
>System Memory	Disc Thickness	1.2mm
>Display	Track Pitch	1.6um
>Memory Expansion	Access Times (typical, including setting)	110 ms
>Battery Pack	Audio Output Level	+/- 0.27 Vrms none
>Diskette Drive	Line out Headphone	
>Hard Drives	Cache Buffer	128 KB
>CD/DVD Drives	Data Transfer Rate (typical, including settings)	3600 KB/s 150 KB/s 16.66 MB/sec
>Modem	Startup Time	< 8 sec
>AC Adapter	Stop time	< 4 sec
>Pin Assignments		
*		

4x DVD-ROM Drive	
Applicable Disk	DVD-ROM, CD-ROM, CD-XA, CD-I, Photo CD, Multisession, Audio, CD-R, CD-RW
Center Hole Diameter	.6" / 15mm
Disc Diameter	120 mm (12cm = 4.72 in.) or 80 mm
Disc Thickness	4.7", 3.15" / 12cm, 8cm
Track Pitch	0.74um (DVD)
Laser Beam Divergence	.05" / 1.2cm
Access Times (typical, including setting)	< 150 ms (DVD)
Audio Output Level	0.8 volts RMS 0 - 0.6 volts RMS
Line out Headphone	
Cache Buffer	512 KB/s
Sustained Data Transfer Rate	5400 KB/s
Startup Time	< 15 sec
Stop time	< 4 sec

MAINTENANCE & SERVICE GUIDE

for Prosignia 150 Series Computer

[Index Page](#)
[Product Description](#)

[Preface -or- Notice](#)
[Illustrated Parts Catalog](#)

[Specifications](#)
[Troubleshooting](#)

[Battery Pack](#)
[Removal & Replacement](#)

Specifications

Modem

*
>System Unit
>System Interrupts
>System DMA
>System I/O
>System Memory
>Display
>Memory Expansion
>Battery Pack
>Diskette Drive
>Hard Drives
>CD/DVD Drives
>Modem
>AC Adapter
>Pin Assignments
*

Compliance	ITU v.90~6 standard Full ITU-T V.34 compliance Full compliance with: V.21, V.22, V.22bis, V.23, V.32, V.32bis, Bell 03, Bell 212A
Data Compression	V.42bis/MNP 5
Fax Modulation	V. 17 V. 21 (Group III Compatible) V.29 V.27Ter
Command Set	Hayes AT Class 1 Fax
Cable	6 Ft. RJ-11 telephone cable

MAINTENANCE & SERVICE GUIDE

for Prosignia 150 Series Computer

[Index Page](#)
[Product Description](#)

[Preface -or- Notice](#)
[Illustrated Parts Catalog](#)

[Specifications](#)
[Troubleshooting](#)

[Battery Pack](#)
[Removal & Replacement](#)

Specifications

AC Adapter

*		
> System Unit	Weight	0.7 lbs/ 0.32 kg
> System Interrupts	Power Supply (Input)	
> System DMA	Operating Voltage	90 to 264 VAC RMS
> System I/O	Operating Current	1.5 A RMS
> System Memory	Operating Frequency	47 to 63 Hz AC
> Display	Range	4KV
> Memory Expansion	Maximum Transient	
> Battery Pack		
> Diskette Drive		
> Hard Drives		
> CD/DVD Drives		
> Modem		
> AC Adapter		
> Pin Assignments		
*		

MAINTENANCE & SERVICE GUIDE

for Prosignia 150 Series Computer

[Index Page](#)
[Product Description](#)

[Preface -or- Notice](#)
[Illustrated Parts Catalog](#)

[Specifications](#)
[Troubleshooting](#)

[Battery Pack](#)
[Removal & Replacement](#)

Connector Pin Assignments

This appendix provides connector pin assignment tables for Compaq Compaq Prosignia 150 Portable Computers. For more information on connectors, refer to the section on [Rear Connectors](#).

Click on a link:

[Parallel Connector](#)

[Serial Connector](#)

[Keyboard/Mouse](#)

[External VGA Monitor](#)

[Universal Serial Bus](#)

[Modem](#)

NOTE: The signals in all tables of this appendix are considered active high unless otherwise indicated by an asterisk (*).

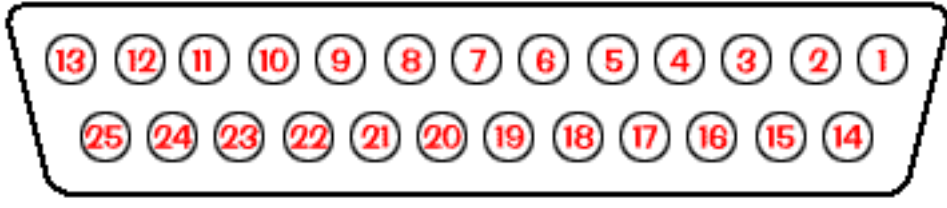
Parallel Connector			
			
Pin	Signal	Pin	Signal
1	Strobe*	10	Acknowledge*
2	Data Bit 0	11	Busy
3	Data Bit 1	12	Paper Out
4	Data Bit 2	13	Select
5	Data Bit 3	14	Auto Linefeed*
6	Data Bit 4	15	Error*
7	Data Bit 5	16	Initialize Printer*
8	Data Bit 6	17	Select In*
9	Data Bit 7	18-25	Signal Ground

* = Active low

[Return to the top.](#)

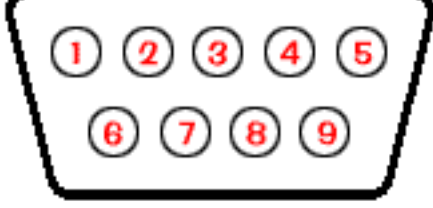
Serial Connector		
Connector	Pin	Signal
	1	Carrier Detect
	2	Receive Data
	3	Transmit Data
	4	Data Terminal Ready
	5	Signal Ground
	6	Data Set Ready
	7	Ready to Send
	8	Clear to Send
	9	Ring Indicator

[Return to the top.](#)

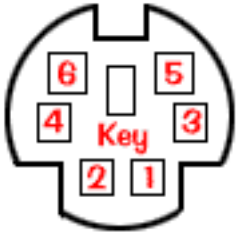
Keyboard/Mouse		
Connector	Pin	Signal
	1	Data 1
	2	Data 2
	3	Ground
	4	+5 V
	5	Clock 1
	6	Clock 2

[Return to the top.](#)

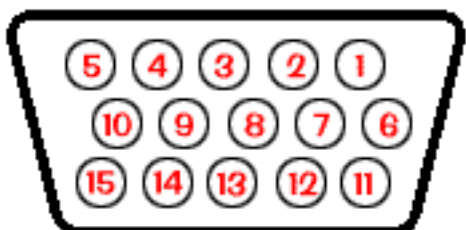
External VGA Monitor		
Connector	Pin	Signal
	1	Red Analog
	2	Green Analog
	3	Blue Analog
	4	Not connected
	5	Ground
	6	Ground Analog
	7	Ground Analog
	8	Ground Analog
	9	Not connected
	10	Ground
	11	Monitor Detect
	12	DDC2B Data
	13	Horizontal Sync
	14	Vertical Sync
	15	DDC2B Clock

[Return to the top.](#)

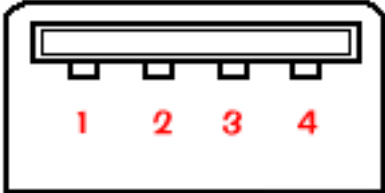
Universal Serial Bus		
Connector	Pin	Signal
	1	+5V
	2	Data -
	3	Data +
	4	Ground

[Return to the top.](#)

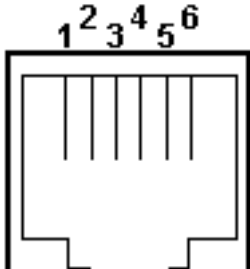
Modem		
Connector	Pin	Signal
	1	Unused
	2	Unused
	3	Tip
	4	Ring
	5	Unused
	6	Unused

[Return to the top.](#)

MAINTENANCE & SERVICE GUIDE

for Prosignia 150 Series Computer

[Index Page](#)
[Product Description](#)

[Preface -or- Notice](#)
[Illustrated Parts Catalog](#)

[Specifications](#)
[Troubleshooting](#)

[Battery Pack](#)
[Removal & Replacement](#)

Troubleshooting

Contacting Compaq Support

.on
> Preliminaries
> Clearing CMOS
> Power-on Self-test
> Compaq Diagnostics
> Diagnostic Error codes
> Test Utilities
> Solving Minor Problems
> Contacting Compaq
.

Obtain the following information before contacting Compaq Reseller Support:

- Product name
- Product serial number
- Purchase date
- Conditions under which the problem occurred
- Any error messages that have occurred
- Hardware configuration
- Type of printer connected
- Hardware/software being used
- Printed result of Computer Checkup (TEST)
- Printed copies of CONFIG.SYS and AUTOEXEC.BAT files, if possible

Shipping Preparation

To ship the computer, complete the following steps:

1. Back up the critical hard drive files. Ensure that backup tapes/diskette are not exposed to electrical or magnetic fields while stored in transit.
2. Turn off the computer and external devices.
3. Disconnect the external devices from their power sources, then from the computer.

Ensure that there is not a diskette in the
IMPORTANT: diskette drive and that there are no PC
Cards in the PC slots.

4. Close the display and all exterior doors of the computer.
5. Pack the computer with sufficient packing material to protect it. Use the original packing box or similar packaging.

MAINTENANCE & SERVICE GUIDE

for Prosignia 150 Series Computer

[Index Page](#)
[Product Description](#)

[Preface -or- Notice](#)
[Illustrated Parts Catalog](#)

[Specifications](#)
[Troubleshooting](#)

[Battery Pack](#)
[Removal & Replacement](#)

Illustrated Parts Catalog

System Unit

*
> System Unit
> Mass Storage Devices
> Board Components
> Cable Kit
> Hardware Kit
> Plastics Kit
> Display Assembly
> Miscellaneous Parts
> Documentation & Software
*

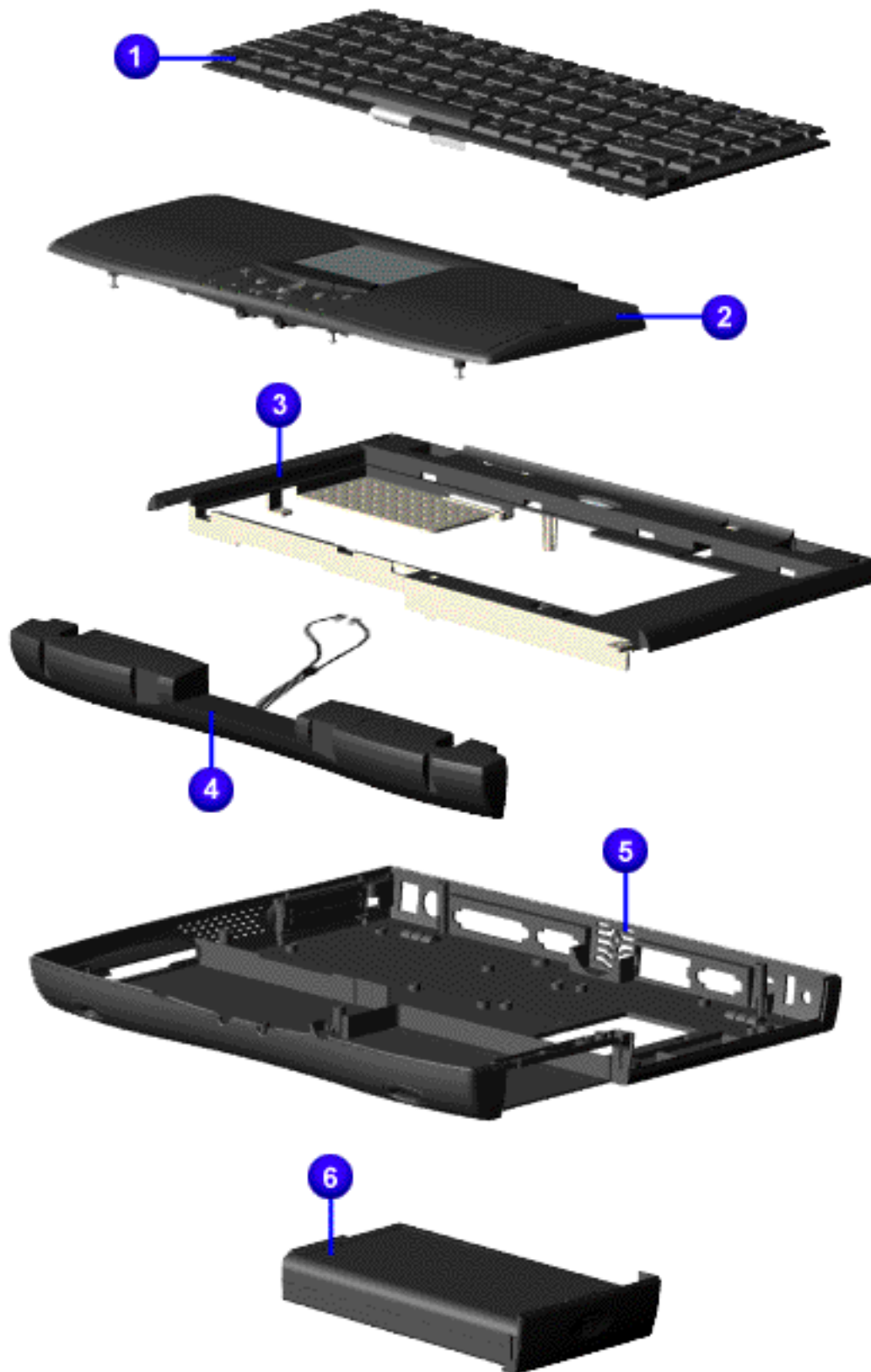

Description	Spare Part Number
1 Keyboard	
US	134092-001
Int'l	134092-002
UK	134092-031
France	134092-051
Japan	134092-291
2 Palmrest Cover w/TouchPad and Button Board	134085-001
2 Palmrest Cover w/TouchPad and Button Board--for 14.1" monitor	134086-001
3 Upper CPU Cover w/Power Switch	134088-001
4 Speaker Assembly w/Enclosures & Cables	352889-001
5 Base Enclosure	134087-001
161065-001	
6 Battery Pack Li Ion	388647-001

MAINTENANCE & SERVICE GUIDE

for Prosignia 150 Series Computer

[Index Page](#)
[Product Description](#)

[Preface -or- Notice](#)
[Illustrated Parts Catalog](#)

[Specifications](#)
[Troubleshooting](#)

[Battery Pack](#)
[Removal & Replacement](#)

Illustrated Parts Catalog

Mass Storage Devices

*
> System Unit
> Mass Storage Devices
> Board Components
> Cable Kit
> Hardware Kit
> Plastics Kit
> Display Assembly
> Miscellaneous Parts
> Documentation & Software
*

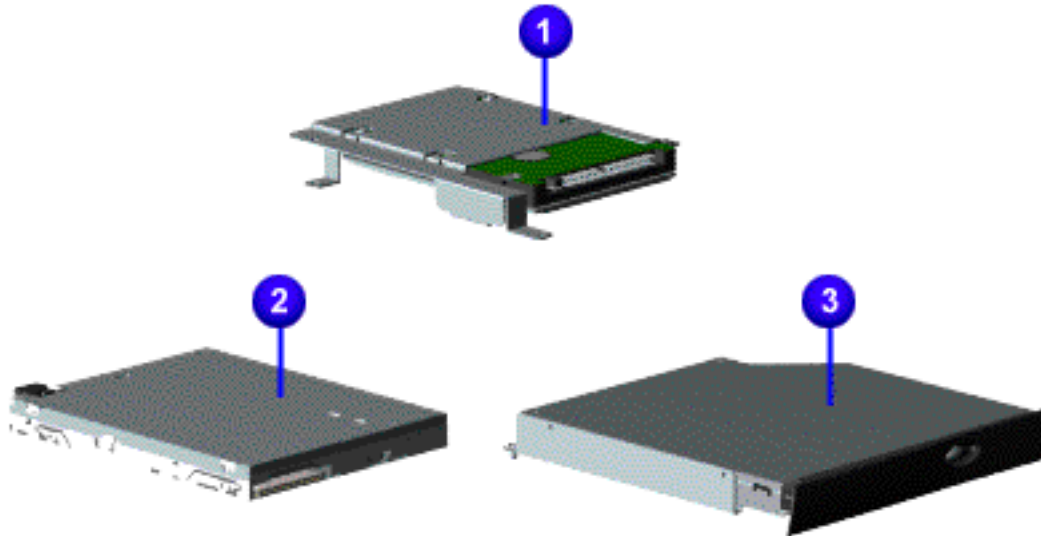

Description	Part Number
1 Hard Drives	
4.0-GB	123927-001
4.3-GB	154475-001
6.4-GB	123928-001
10.0-GB	118166-001
2 1.44-MB Diskette Drive	134089-001
3 4x DVD Drive	134084-001
24x CD Drive	134083-001

MAINTENANCE & SERVICE GUIDE

for Prosignia 150 Series Computer

[Index Page](#)
[Product Description](#)

[Preface -or- Notice](#)
[Illustrated Parts Catalog](#)

[Specifications](#)
[Troubleshooting](#)

[Battery Pack](#)
[Removal & Replacement](#)

Illustrated Parts Catalog

Board Components

.
> System Unit
> Mass Storage Devices
> Board Components
> Cable Kit
> Hardware Kit
> Plastics Kit
> Display Assembly
> Miscellaneous Parts
> Documentation & Software
.

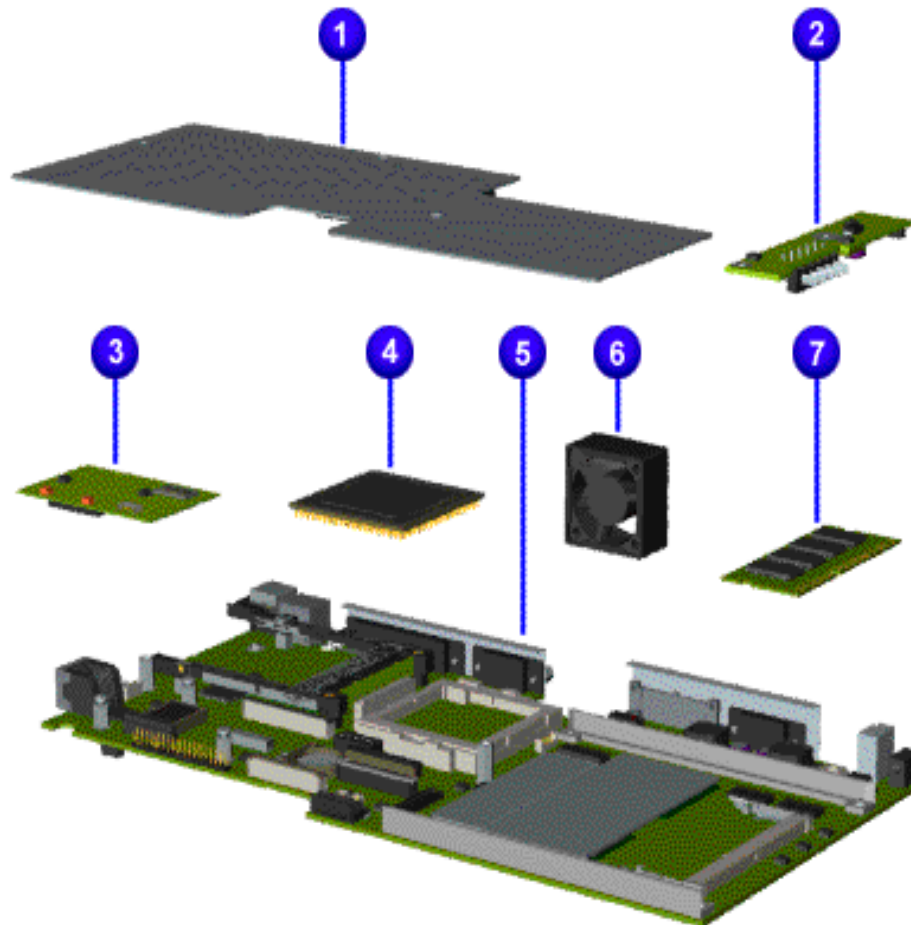

Description	Spare Part Number
1 Heatspreader	152620-001
2 Voltage Converter Board	352891-001
3 Modem 56K Data/Fax w/o SRAM	
US	400445-001
International	134136-021
4 AMD K6-2 Processors:	
350-Mhz	122698-001
380-Mhz	123923-001
400-MHz	134079-001
433-Mhz	158851-001
475-MHz	161064-001
5 System Boards	
System Board I/O	400440-001
System Board I/O with 1MB Cache	158849-001
6 Fan Assembly	400444-001
7 System memory	
32-MB	122699-001
64-MB	122700-001

MAINTENANCE & SERVICE GUIDE

for Prosignia 150 Series Computer

[Index Page](#)
[Product Description](#)

[Preface -or- Notice](#)
[Illustrated Parts Catalog](#)

[Specifications](#)
[Troubleshooting](#)

[Battery Pack](#)
[Removal & Replacement](#)

Illustrated Parts Catalog

Miscellaneous Cables Kit

*
>System Unit
>Mass Storage Devices
>Board Components
>Cable Kit
>Hardware Kit
>Plastics Kit
>Display Assembly
>Miscellaneous Parts
>Documentation & Software
*

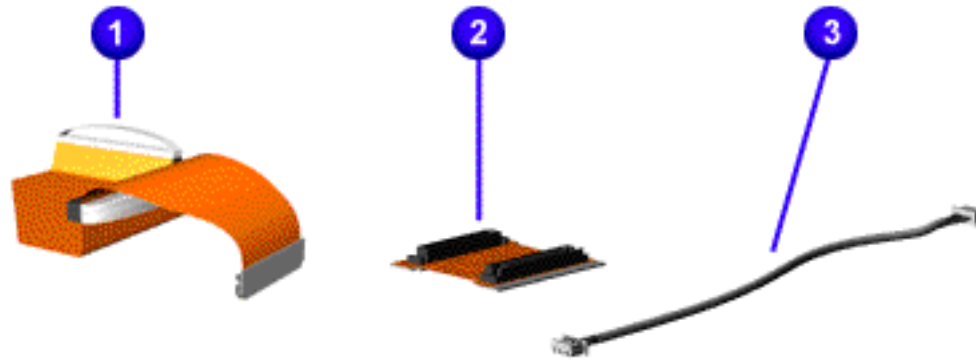

Spare Part
Number:
330946-001
1 Diskette
Drive Cable
2 CD or DVD
Drive Cable
3 Modem
Cable

MAINTENANCE & SERVICE GUIDE

for Prosignia 150 Series Computer

[Index Page](#)
[Product Description](#)

[Preface -or- Notice](#)
[Illustrated Parts Catalog](#)

[Specifications](#)
[Troubleshooting](#)

[Battery Pack](#)
[Removal & Replacement](#)

Illustrated Parts Catalog

Miscellaneous Hardware Kit

*
> System Unit
> Mass Storage Devices
> Board Components
> Cable Kit
> Hardware Kit
> Plastics Kit
> Display Assembly
> Miscellaneous Parts
> Documentation & Software
*

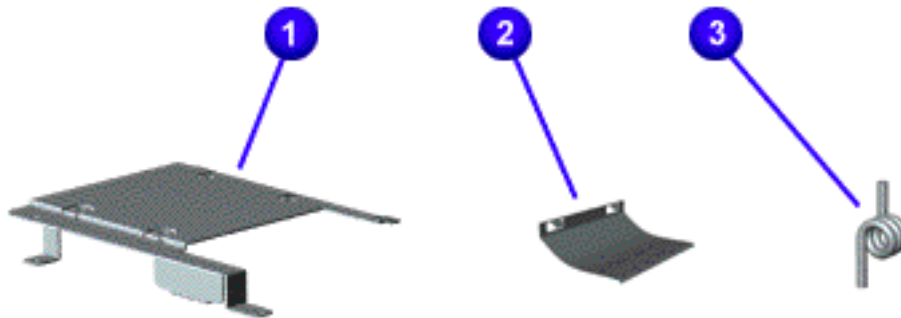

Spare Part Number:
346853-001

Description	Quantity
1 Hard Drive Mounting Bracket	1 each
2 LCD Guide FPC	1 each
3 Spring Torsion PCMCIA	4 each

MAINTENANCE & SERVICE GUIDE

for Prosignia 150 Series Computer

[Index Page](#)
[Product Description](#)

[Preface -or- Notice](#)
[Illustrated Parts Catalog](#)

[Specifications](#)
[Troubleshooting](#)

[Battery Pack](#)
[Removal & Replacement](#)

Illustrated Parts Catalog

Miscellaneous Plastics Kit

*
> System Unit
> Mass Storage Devices
> Board Components
> Cable Kit
> Hardware Kit
> Plastics Kit
> Display Assembly
> Miscellaneous Parts
> Documentation & Software
*

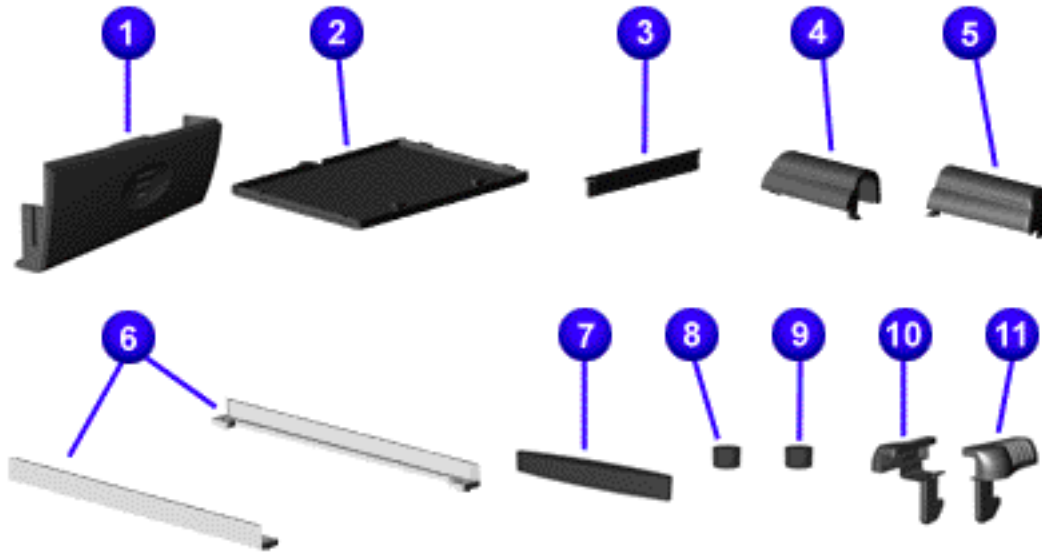

Spare Part Number: 134090-001	
Description	Quantity
1 Door, Battery Pack	1 each
2 Cover, Memory Module	1 each
3 Door, PCMCIA	1 each
4 Display Hinge Cover, (Left)	1 each
5 Display Hinge Cover, (Right)	1 each
6 CD Drive Guide	1 each
7 Rubber Plug (A)	4 each
8 Rubber Plug (B)	4 each
9 Rubber Foot	8 each
10 Latch (Right)	2 each
11 Latch (Left)	2 each

MAINTENANCE & SERVICE GUIDE

for Prosignia 150 Series Computer

[Index Page](#)
[Product Description](#)

[Preface -or- Notice](#)
[Illustrated Parts Catalog](#)

[Specifications](#)
[Troubleshooting](#)

[Battery Pack](#)
[Removal & Replacement](#)

Illustrated Parts Catalog

Display Panel Assembly

*
> System Unit
> Mass Storage Devices
> Board Components
> Cable Kit
> Hardware Kit
> Plastics Kit
> Display Assembly
> Miscellaneous Parts
> Documentation & Software
*

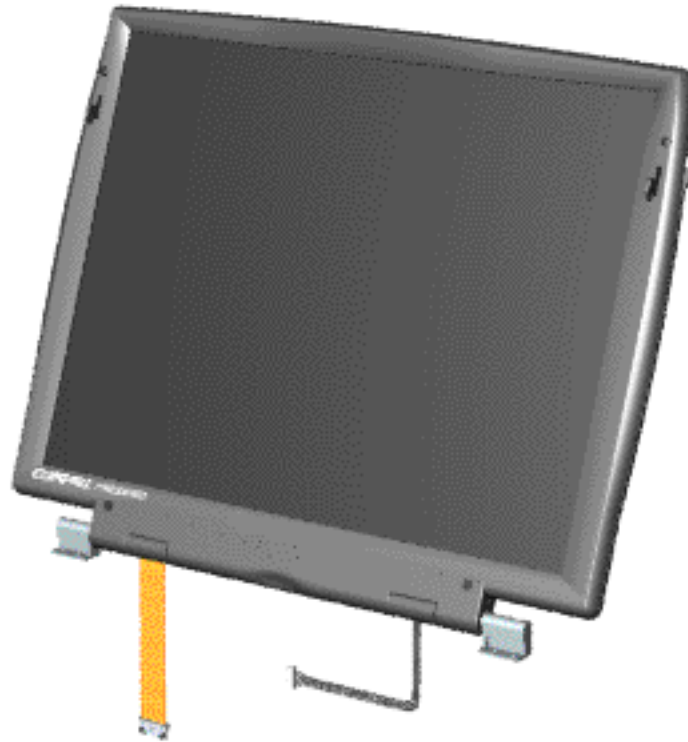

Description	Spare Part Number
12.1 TFT w/LVDS	134081-001
14.1 TFT w/LVDS	134082-001

MAINTENANCE & SERVICE GUIDE

for Prosignia 150 Series Computer

[Index Page](#)
[Product Description](#)

[Preface -or- Notice](#)
[Illustrated Parts Catalog](#)

[Specifications](#)
[Troubleshooting](#)

[Battery Pack](#)
[Removal & Replacement](#)

Illustrated Parts Catalog

Miscellaneous Parts

*
> System Unit
> Mass Storage Devices
> Board Components
> Cable Kit
> Hardware Kit
> Plastics Kit
> Display Assembly
> Miscellaneous Parts
> Documentation & Software
*

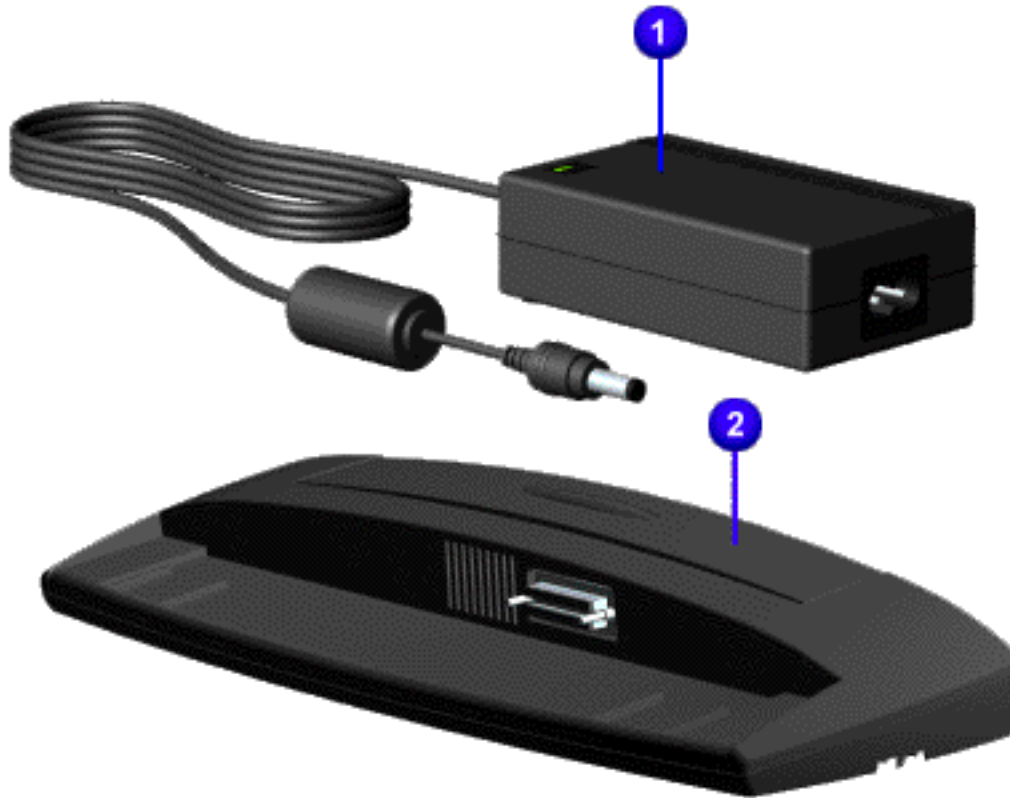

Description	Part Number
1 AC Adapter	298239-001

2 Port Replicator	102270-001
-------------------	------------

Parts Not Shown:

Description	Part Number
Misc. Screw Kit	330959-001
Logo Kit	134091-001
Return Kit	293799-001
AC Power Cord	
USA	293831-001
Int'l	293831-002
UK	293831-031
Japan	293831-291

MAINTENANCE & SERVICE GUIDE

for Prosignia 150 Series Computer

[Index Page](#)
[Product Description](#)

[Preface -or- Notice](#)
[Illustrated Parts Catalog](#)

[Specifications](#)
[Troubleshooting](#)

[Battery Pack](#)
[Removal & Replacement](#)

Illustrated Parts Catalog Documentation & Software

.	Description	Spare Part Number
> System Unit		
> Mass Storage Devices	Quick Restore, Windows 98	
> Board Components	USA	1 18621-001
> Cable Kit	France	1 18621-051
> Hardware Kit	Quick Reference Guide	
> Plastics Kit	(quarterly subscription)	184960-001
> Display Assembly	QuickFind for	137906-xxx
> Miscellaneous Parts	Windows, United States	
> Documentation & Software	* QuickFind is updated monthly. To complete the QuickFind part number, add the suffix from the table below for the desired month. If you do not specify the 3-digit suffix, the default is the current month in which the order is placed.	
.		

QuickFind Part Number Suffix			
Suffix	Month	Suffix	Month
-001	January	-007	July
-002	February	-008	August
-003	March	-009	September
-004	April	-010	October
-005	May	-011	November
-006	June	-012	December