

Follow the instructions in this chapter to set up your computer.

1

Setting Up Your Computer



The illustration on the next page shows all the equipment you will need to set up your computer and begin using it. (Note that your monitor and keyboard may look slightly different depending on what you purchased.)

Before following the setup instructions in this chapter, you may want to read “Arranging Your Office” in Appendix A for tips on adjusting your work furniture so that you’re comfortable when using the computer.

This chapter describes the basics of setting up your computer: plugging it in; connecting a monitor, keyboard, and mouse; and turning it on for the first time. For information on connecting and installing other equipment, such as external hard disks, printers, audio equipment, memory, and expansion cards, see Chapter 7, “Connecting Additional Equipment” and Chapter 8, “Installing PCI Expansion Cards and Additional Memory,” after you have followed the instructions in this chapter to set up your computer.

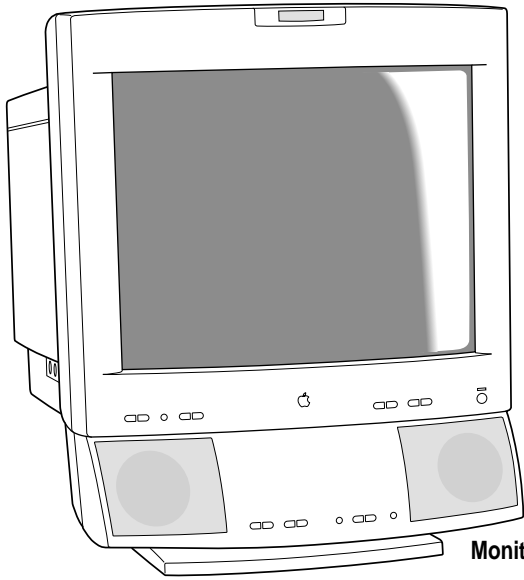

Monitor

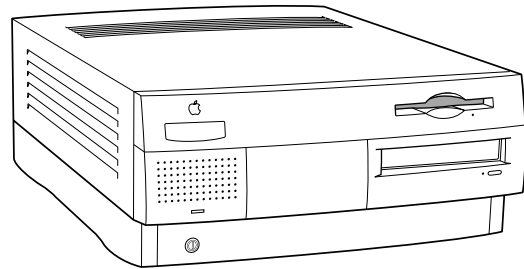

Macintosh computer

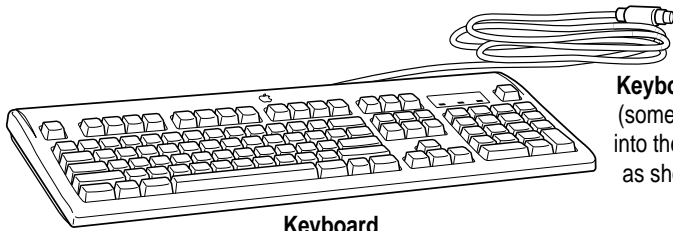

Keyboard



Security bar and screw

Keyboard cable
(sometimes built into the keyboard as shown here)

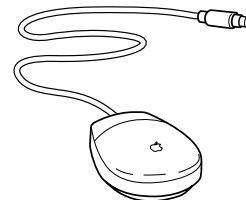

Mouse

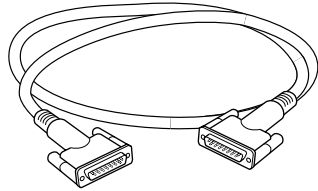

Monitor cable
(sometimes built into the monitor)

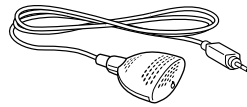

Apple PlainTalk Microphone (optional)

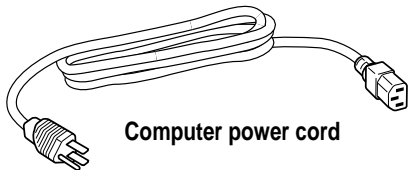

Computer power cord

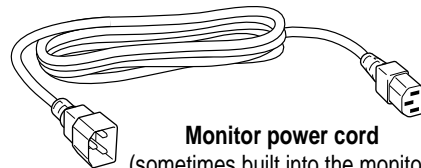

Monitor power cord
(sometimes built into the monitor)

Positioning the computer

Place your computer on a sturdy, flat surface near a grounded wall outlet.

Your Power Macintosh was designed to be used and carried in the horizontal position, as shown below—it should not be used tipped on its side. You may place monitors weighing up to 70 pounds (31.75 kilograms) on top of the computer.

IMPORTANT When picking up your computer, be sure to grasp it by the sides. Grasping it by the front or back can cause the computer's cover to lift off.

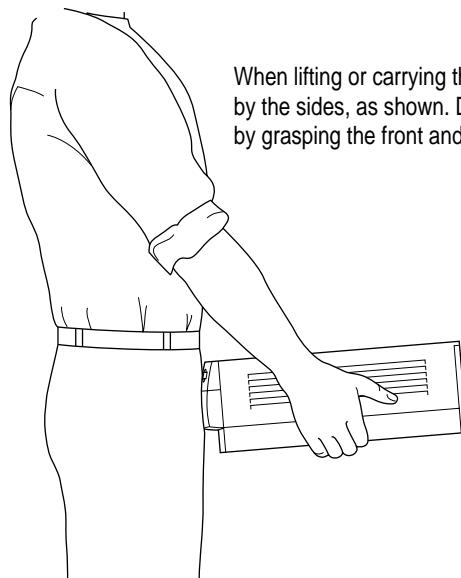

When lifting or carrying the computer, always grasp it by the sides, as shown. Do not lift or carry the computer by grasping the front and back.

Plugging in the computer

Before you plug your Macintosh into a wall socket, carefully read all the setup instructions in this chapter. Then, before you connect any other equipment to your Macintosh, follow the instructions in this section to plug it in. The plug grounds the computer and protects it from electrical damage while you set up. When you are ready to begin, follow these steps:

- 1 **Make sure the voltage switch on the back of the computer is set for the kind of voltage system to which you will be connecting.**

The voltage switch must be set correctly to avoid damaging your computer. If you don't know the voltage used in the country you're in, refer to the table "Voltage for Different Locations" later in this chapter.

WARNING Setting the correct voltage for your computer does not set the voltage for your monitor even if the monitor's power cord is connected directly to your computer. To protect your monitor, be sure to use the appropriate adapter or voltage converter, if one is necessary.

Check to see that the voltage switch on the back of your computer is properly set before you plug it in. If you need to change the setting, insert a small screwdriver in this slot and slide the switch.

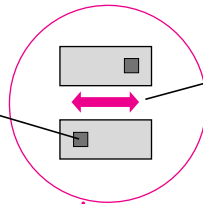

Set the switch to show "115" for voltages in the 100–130 V range.
Set the switch to show "230" for voltages in the 200–270 V range.

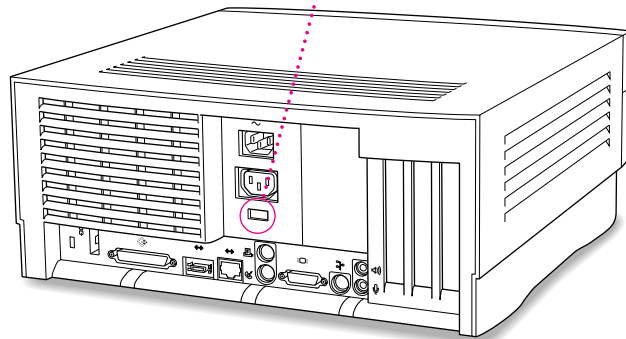

Voltages for different locations

Country	Single voltage
Japan	100
South Korea	100/220
Jamaica, Taiwan	110
Peru	110/220
Brazil, Lebanon	110–220
Philippines	115
Bermuda, Canada, Puerto Rico, United States, Venezuela	120
Mexico	127
Saudi Arabia	127/220
Hong Kong	200
India, South Africa	220–250
Israel, Pakistan, Singapore	230
Australia, Kuwait, Malta, New Zealand, Northern Ireland, Papua New Guinea, Oman, Qatar, United Kingdom	240
Austria, Belgium, Denmark, Finland, France, Germany, Greece, Italy, Luxembourg, Netherlands, Norway, Portugal, Spain, Sweden, Switzerland	220–230
Bahrain, Chile, China (People's Republic), Czechoslovakia, Egypt, Greenland, Hungary, Iceland, Indonesia, Iran, Jordan, Liechtenstein, Nepal, Paraguay, Poland, Romania, United Arab Emirates, Russia and the Commonwealth of Independent States (CIS), Yemen, Yugoslavia	220

- 2 Plug the socket end of the computer's power cord into the recessed power socket (marked with the symbol ~) on the back of the computer.
- 3 Plug the other end of the power cord into a three-hole grounded outlet or power strip.

WARNING Be sure to set the voltage switch on the back of your computer for the voltage system to which you're connecting.

This equipment is intended to be electrically grounded. Your Macintosh is equipped with a three-wire grounding plug—a plug that has a third (grounding) pin. This plug will fit only a grounded AC outlet. This is a safety feature. If you are unable to insert the plug into the outlet, contact a licensed electrician to replace the outlet with a properly grounded outlet. Do not defeat the purpose of the grounding plug!

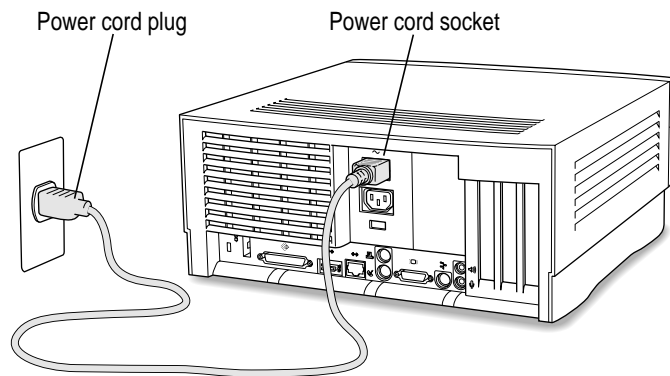

IMPORTANT The only way to disconnect power completely is to unplug the power cord. Make sure that at least one end of the power cord is within easy reach so that you can unplug the computer when you need to.

Connecting a monitor

You can connect many types of monitors to your Macintosh computer, including most standard monitors. See the *Technical Information* booklet that came with your computer for a complete list.

This section contains instructions for connecting most types of monitors. You should also refer to the instructions that came with the monitor for any special instructions.

IMPORTANT If you are connecting an Apple monitor that has built-in speakers or a microphone, you may need to install monitor software after you have set up and turned on your computer. Otherwise, you may not be able to use all the monitor's features. See the instructions that came with the monitor for more information.

Connecting the monitor power cord

At minimum, monitors have two cords to connect: a power cord and a monitor cable. To connect the monitor power cord, follow these steps:

1 Place the monitor near the computer.

Keep these considerations in mind:

- You can place monitors weighing up to 70 lbs. (31.75 kg) on top of the computer.
- Allow at least three inches for air circulation around the computer and monitor.
- Make sure that the top of the screen is slightly below eye level when you're sitting at the keyboard.
- Position the monitor to minimize glare and reflections on the screen from overhead lights and windows.

For further suggestions about positioning your computer equipment, consult "Arranging Your Office" in Appendix A (in the section on health-related information).

2 Connect the monitor power cord to the monitor.

On some monitors, the cord is already attached.

3 Plug in the monitor power cord.

Some monitor power cords are designed to plug into the back of your computer.

Some monitor power cords must be connected to a grounded electrical outlet, not to the computer. Check the information that came with the monitor.

WARNING Setting the correct voltage for your computer does not set the voltage for your monitor even if the monitor's power cord is connected directly to your computer. To protect your monitor, be sure to use the appropriate adapter or voltage converter, if one is necessary.

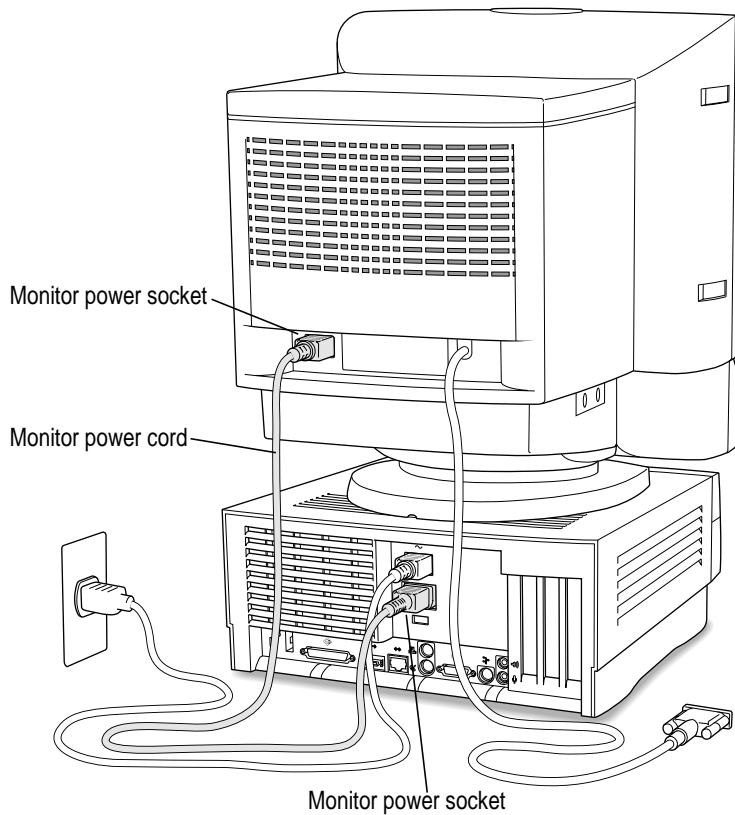

Connecting the monitor cable and ADB cable

After you plug in the monitor power cord, you connect the monitor cable to the computer's monitor port. Some monitors also include a cable called an Apple Desktop Bus (ADB) cable, which you connect between the ADB ports (marked with the  icon) on the monitor and the computer.

To connect the monitor cable and the ADB cable, follow these steps:

- 1 Attach the monitor cable to the monitor.**

On some monitors, the cable is already attached.

- 2 Attach the monitor cable to the monitor port on the back panel of the computer.**

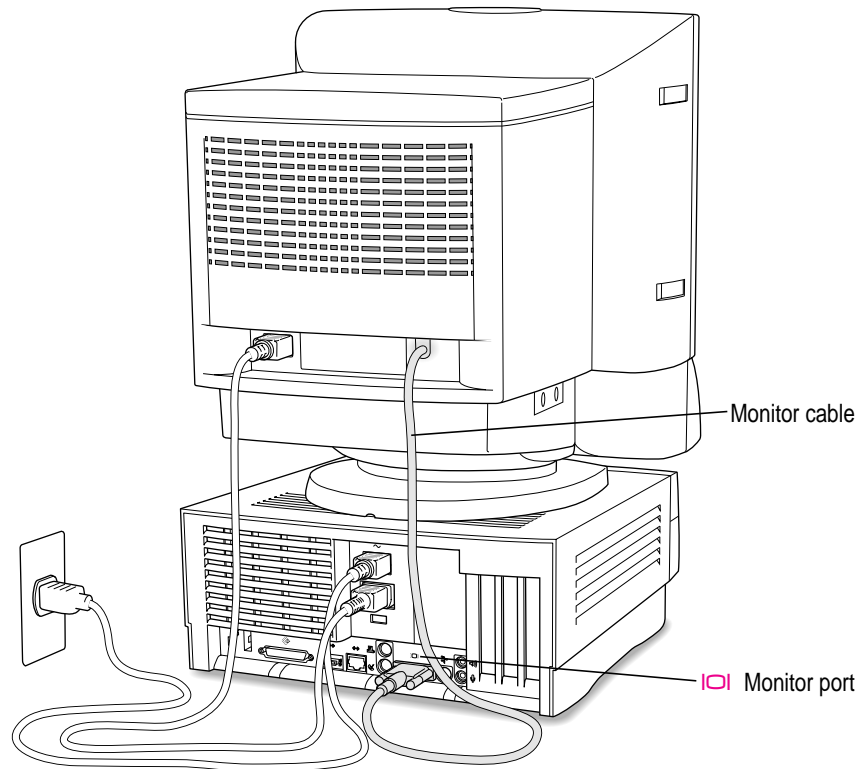

- 3 If your monitor came with an ADB cable, connect it according to the instructions that came with your monitor.

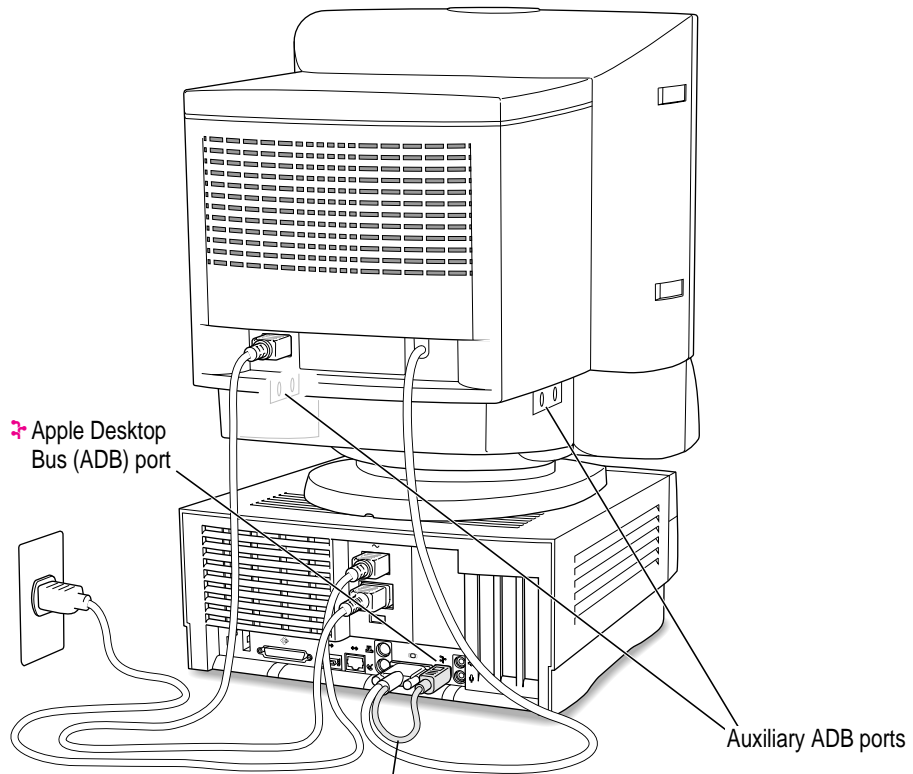

Some monitors (such as this AppleVision 1710AV Display) come with an ADB (⌘) cable that you can plug into the ADB port on the back of your computer. This allows you to connect either a keyboard, a mouse, or other ADB device directly into the monitor's auxiliary ADB ports.

Connecting the mouse and keyboard

The way you connect the mouse and keyboard depends on whether the keyboard has a built-in cable or a separate cable.

Connecting a keyboard with a built-in cable

- 1 **Plug the mouse cable into the recessed port on the back of the keyboard.**

The plug and the port are marked with the ⌘ icon (symbol). The positions of the port and icon on your keyboard may be different from those pictured.

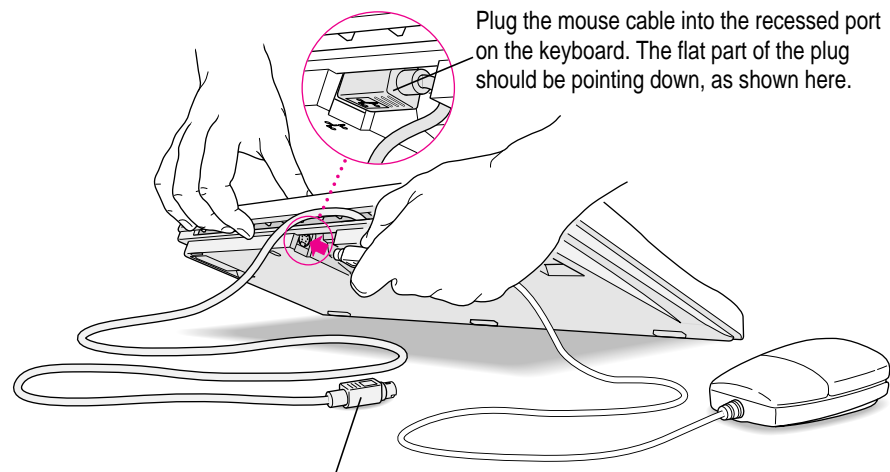

This cable plugs into the Apple Desktop Bus (ADB) port, marked with the ⌘ icon, on the back of the computer.

- 2 **If the front or side of your monitor has a port marked with the ⌘ icon, plug the keyboard cable into this port. Otherwise, plug the keyboard cable into the port marked with the ⌘ icon on the back of the computer.**

- 3 If you want to adjust the angle of the keyboard, lower its feet.

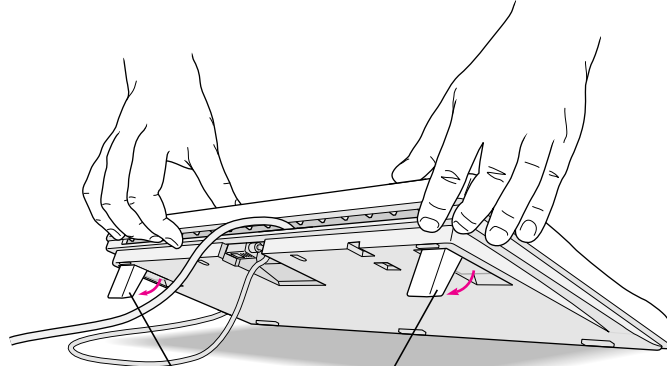

To adjust the angle of the keyboard, lower the feet until they snap into position.

Connecting a keyboard with a separate cable

- 1 Plug the mouse cable into the port on either side of the keyboard.

Most right-handed people prefer to use the mouse with their right hand; most left-handed people prefer to use their left hand. Plug the mouse into the port on the side you prefer.

The plug and the port are marked with the  icon (symbol). Align the symbols before you insert the plug. (The positions of the port and icon on your keyboard may be different from those pictured here.)

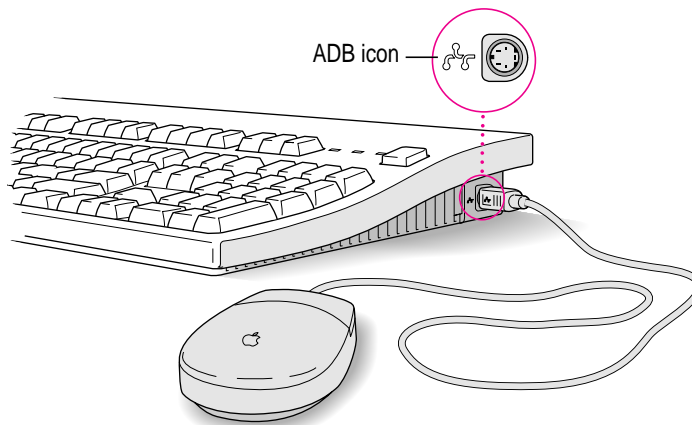

- 2 Plug the keyboard cable (both ends are the same) into the other ADB port on the keyboard.**

If you plugged the mouse cable in on the right, for example, plug the keyboard cable in on the left.

- 3 If the front or side of your monitor has a port marked with the ⌘ icon, plug the keyboard cable into this port. Otherwise, plug the keyboard cable into the port marked with the ⌘ icon on the back of the computer.**
- 4 If you want to adjust the angle of the keyboard, slide the tab at the back of the keyboard.**

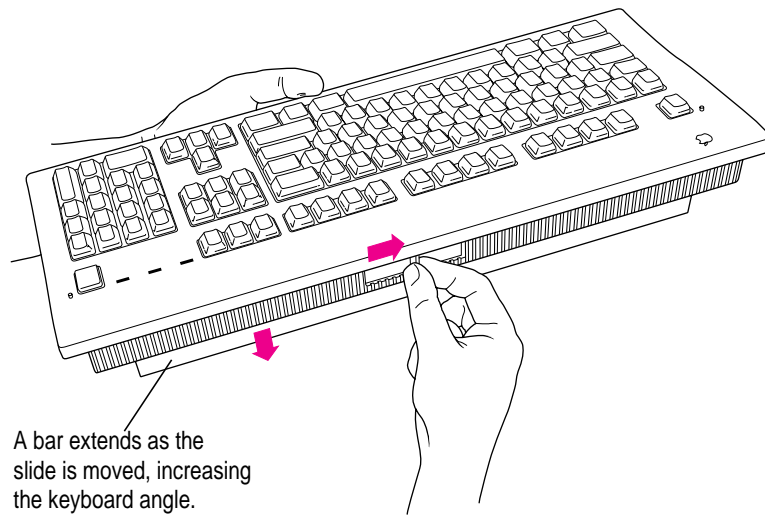

A bar extends as the slide is moved, increasing the keyboard angle.

Turning the computer on

To turn on the computer for the first time, follow these steps:

1 Turn on your monitor.

See the information that came with your monitor for the location of the power switch. On newer Apple monitors, the power switch is located on the front of the unit.

Note: You may not see the monitor power come on until you turn on the computer in the next step.

By the way: Depending on the type of monitor you have, you may only need to turn it on once. Some monitors will turn off automatically when you shut down the computer and turn on automatically when you start up the computer. With other monitor types, you may have to turn the monitor on or off separately.

2 Turn on your computer by pressing the Power key.

The Power key is marked with a triangle on your keyboard.

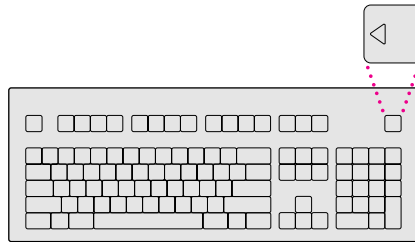

You should hear a tone from the computer as it starts up. If you don't, press the Power key again, and hold down the key a little longer this time.

3 Check to see what's on your screen.

You'll see a sequence of messages describing what is happening, followed by the Energy Saver dialog box. (If your computer does not start up properly, see "Problems Turning Your Computer On?" next.)

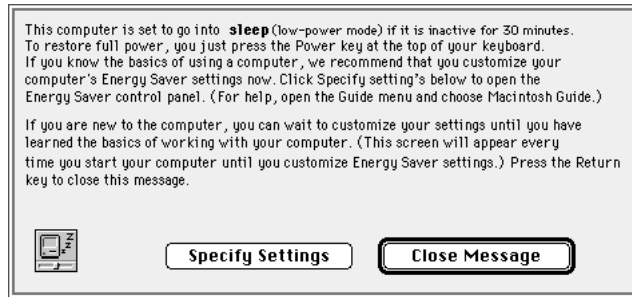

4 Do one of the following.

- If you're a beginning Macintosh user, press the Return key to close this dialog box. You can set your Energy Saver options later.
- If you're an experienced Macintosh user, you may want to set your energy-saving options now. Click Specify Settings to open the Energy Saver window. After you are done setting your energy-saving options, click the close box to close the Energy Saver window.

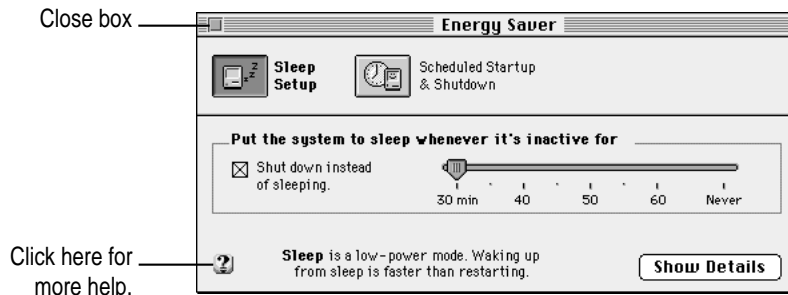

5 If you see the Macintosh “desktop” (shown here), skip now to “What’s Next?”

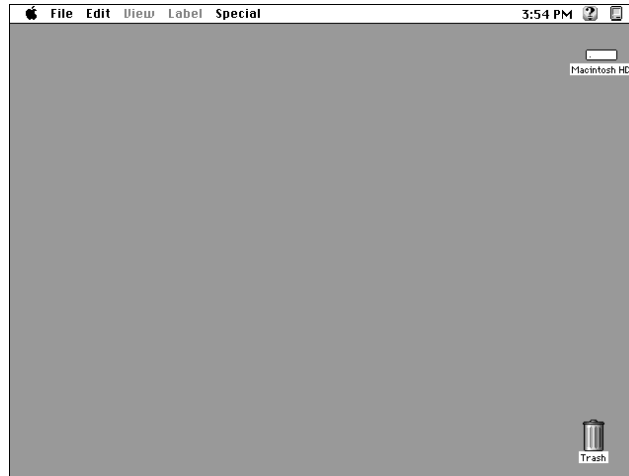



IMPORTANT If you want to turn off your computer, be sure to follow the proper shutdown procedure explained at the end of Chapter 2, “Learning to Use Your Computer.”

Problems turning your computer on?

If you don’t see anything on your screen or you think your computer did not start up properly, check these items to see if you can identify the problem:

- Is the computer plugged into a power source? If it is plugged into a power strip, is the power strip turned on?
- Is the computer turned on? The power-on light on the front panel of the computer should be on. If it isn’t, press the power button, which is also on the front panel.
- Are the keyboard and mouse cables connected correctly? (Don’t connect or disconnect the keyboard or mouse cable while the computer is on. You could damage your equipment. To turn off your computer, press the power button on its front panel.)

- If you connected an ADB cable between the monitor and the computer, is it attached firmly to the ports marked with  icons? (Don't connect or disconnect this cable while the computer is on. You could damage your equipment. To turn off your computer, press the power button on its front panel.)
- Is the monitor power cord plugged in?
- Is the monitor cable—the one connected to the monitor port (I/O) on your computer—attached firmly to both the monitor and computer?
- Is the monitor turned on? (Check the power-on light on the front of the monitor.)
- Is the brightness control on the monitor adjusted correctly? (On most monitors, the brightness control is marked with the symbol .)
- Is the computer asleep? To wake the computer, press the Power key (marked with a ) on the keyboard. It may take a moment or two for the computer to wake up.
- If you see a blinking question mark, see Chapter 9, “Start Here If Trouble Occurs.”

What's next?

Congratulations—you've finished setting up your computer. If this is the first time you've used a Macintosh computer, turn to Chapter 2, “Learning to Use Your Computer.”

If you already know how to use a Macintosh computer, continue with the next section, “Where to Find Answers.”

IMPORTANT If you want to turn off your computer, be sure to follow the proper shutdown procedure explained at the end of Chapter 2, “Learning to Use Your Computer.”

Where to find answers

When you have questions about using your Macintosh, there are several places you can look for answers.

Macintosh User's Manual

Use this book to help you set up your computer and learn about it, or to find solutions to problems.



Other manuals

For answers to questions about other equipment or about application programs you have purchased, see the manuals that came with the equipment or programs.

Apple Guide

If you need help or experience a problem while using the computer, open the Guide (⌘) menu and choose Macintosh Guide (or Mac OS Guide). The Guide menu is the main source for information while you are using the computer.



Apple's customer support hotline

If you can't find an answer in any of the materials provided, call the customer support hotline. (The phone number for the hotline is in the service and support information that came with your computer.)

Four simple tips for using Macintosh Guide effectively

- 1 When you don't see Macintosh Guide (or Mac OS Guide) in the Guide menu**

Macintosh Guide (or Mac OS Guide) is only available while you're in the Finder, the system software program that creates and displays your Macintosh desktop. To go to the Finder, do one of the following.

 - Click the desktop (the colored or patterned background area of your screen).
 - Pull down the Application menu (to the right of the Guide menu) and choose Finder.
- 2 When you can't find the information you need**
 - In searching for help topics, use one of the three buttons at the top of the Guide's initial window by clicking them: Topics, Index, and Look For.
 - If you're in a series of steps and want to return to the list of help topics, click the Topics button.
- 3 When you can't see what's behind the Guide window**

Guide windows stay in front of other windows on the screen so that your instructions are never covered.

 - Drag a Guide window by its title bar to move it out of the way.
 - Click the zoom box once to shrink a Guide window. (To expand the window, click the zoom box a second time.)
- 4 When you need more information about an instruction or term**
 - Click the "Huh" button if it is available.

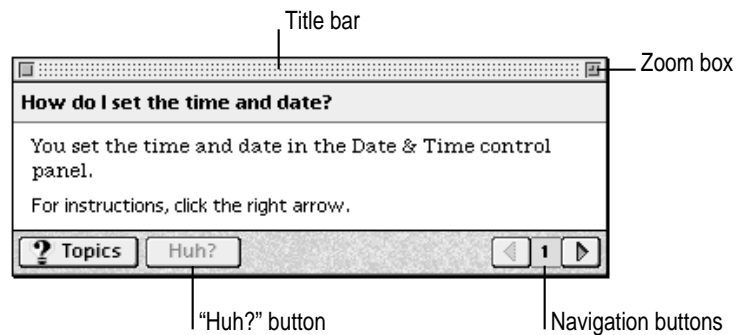

Identifying Objects

If you see something unfamiliar on the screen, open the Guide menu and choose Show Balloons. Then point to the object you want to identify. When you're done, choose Hide Balloons from the Guide menu.

This is an example of balloon help.

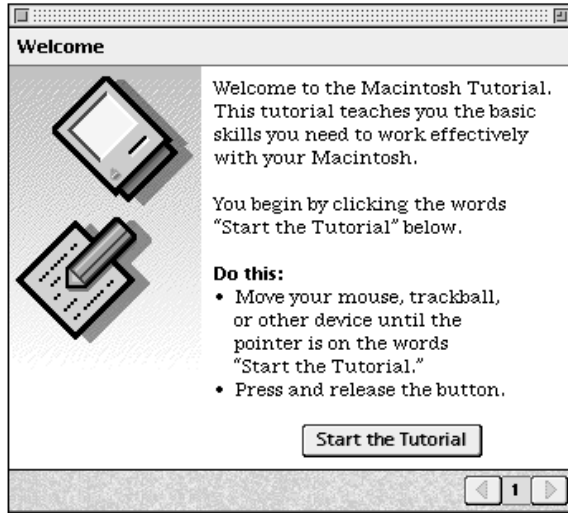

Learning the Basics

To learn basic skills, open the Guide menu and choose Macintosh Tutorial. Then follow the instructions on the screen.

Getting Help via the Internet

If you have an Internet connection, you can get information from the Apple World Wide Web site at <http://www.apple.com>. (For more information about the Internet, see Chapter 6.)

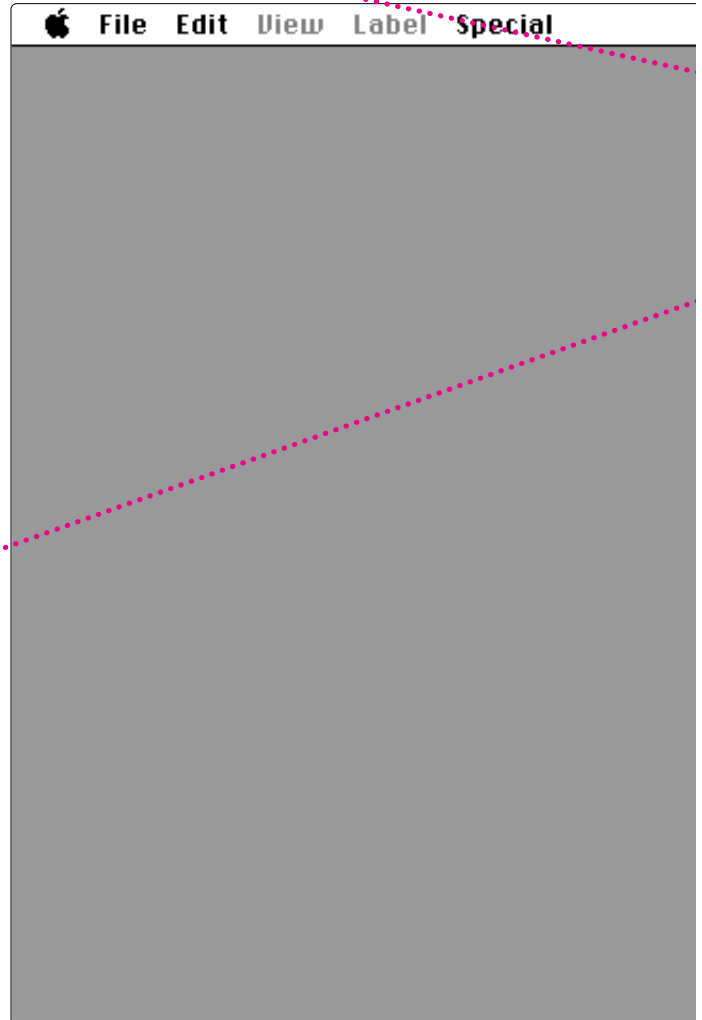



The Guide Menu

To find an answer to a question, look in the Guide (📖) menu—your main source of information about your computer.

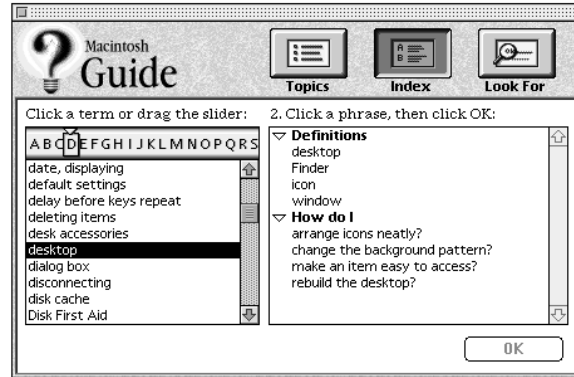
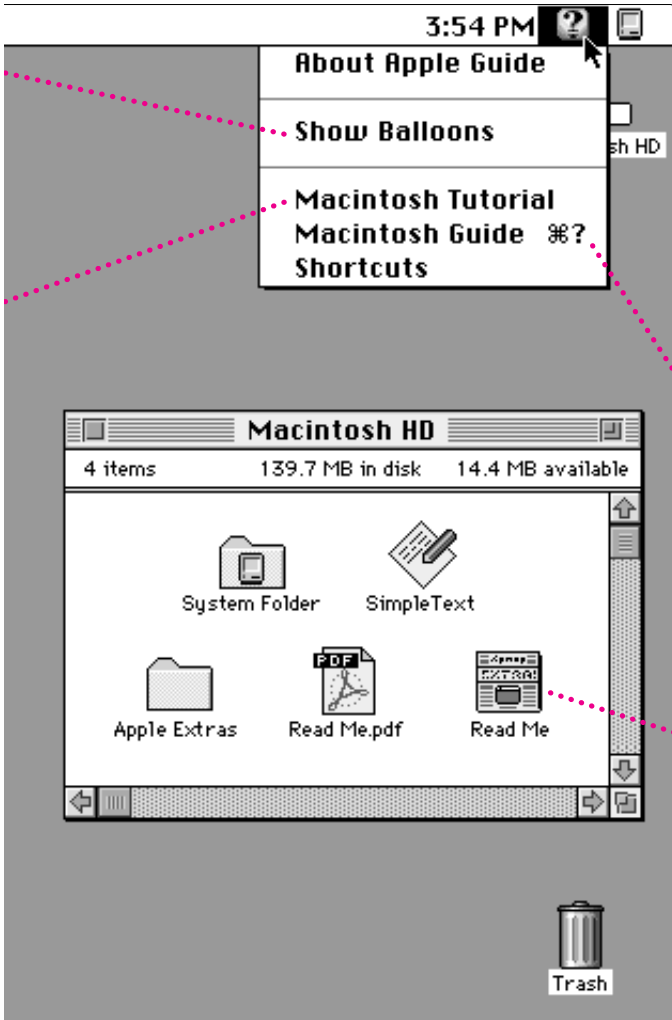

Getting Answers to Your Questions

To get answers to questions you have while working with your computer, open the Guide menu and choose Macintosh Guide (or Mac OS Guide) or a Guide for the program you are using. Then click one of the three buttons at the top of the window: Topics, Index, or Look For, and follow the instructions to choose a subject.

Getting the Latest News

Double-click the hard disk icon to see the “Read Me” file pictured here, which contains last-minute tips and news. Many other Read Me documents are in the Apple Extras folder.

To open a Read Me document that has “pdf” in the icon or in the file name, you first need to install the Adobe Acrobat Reader program, which is available in the Apple Extras folder.

Reviewing the basics

Use the following illustrations to review the onscreen elements you use to work with your computer.

Menus

The strip across the top of the screen is called the menu bar. The symbols and words in it contain menus of commands. To open a menu, place the pointer on the symbol or word for the menu and press the mouse button.

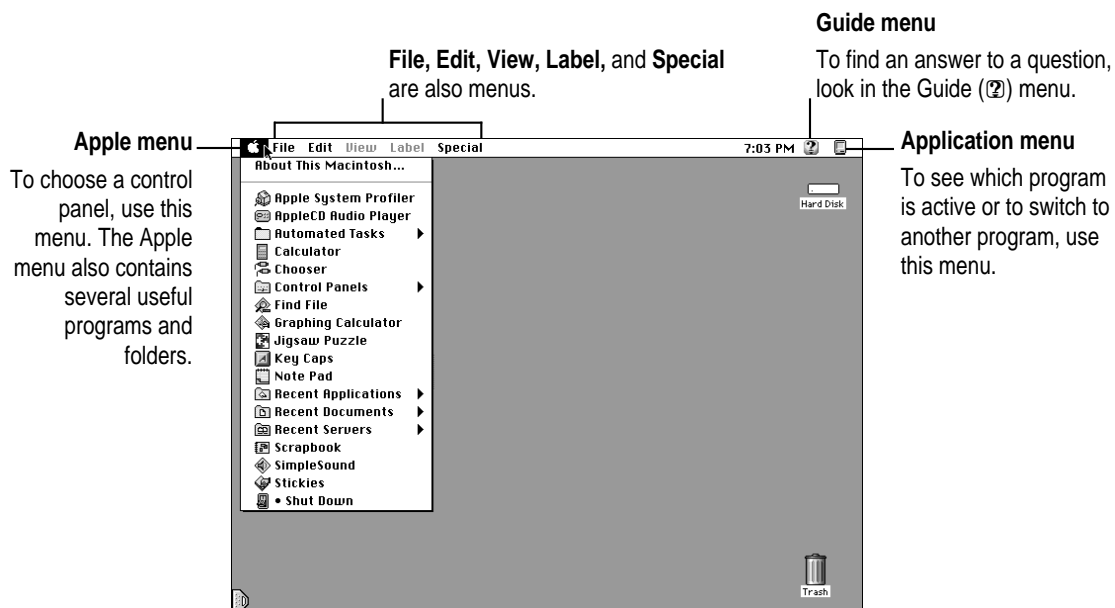

Windows

Windows are boxes that display text, graphics, or icons. To change the shape or position of a window, or to close a window, use the elements shown here.

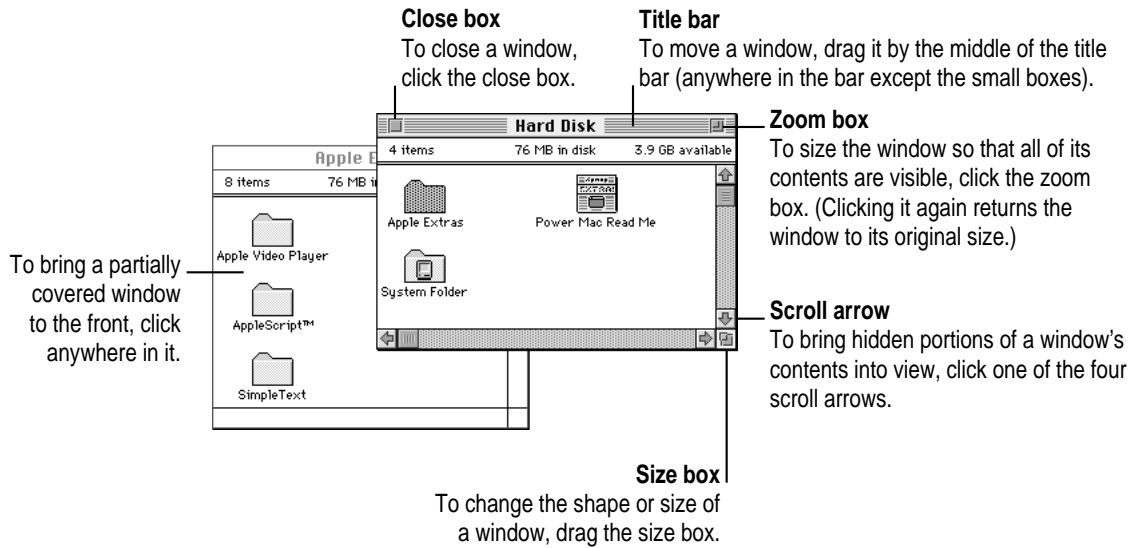

Icons

Icons are small pictures that represent disks, programs, documents, and folders. You can double-click any icon to open it and see what it contains.

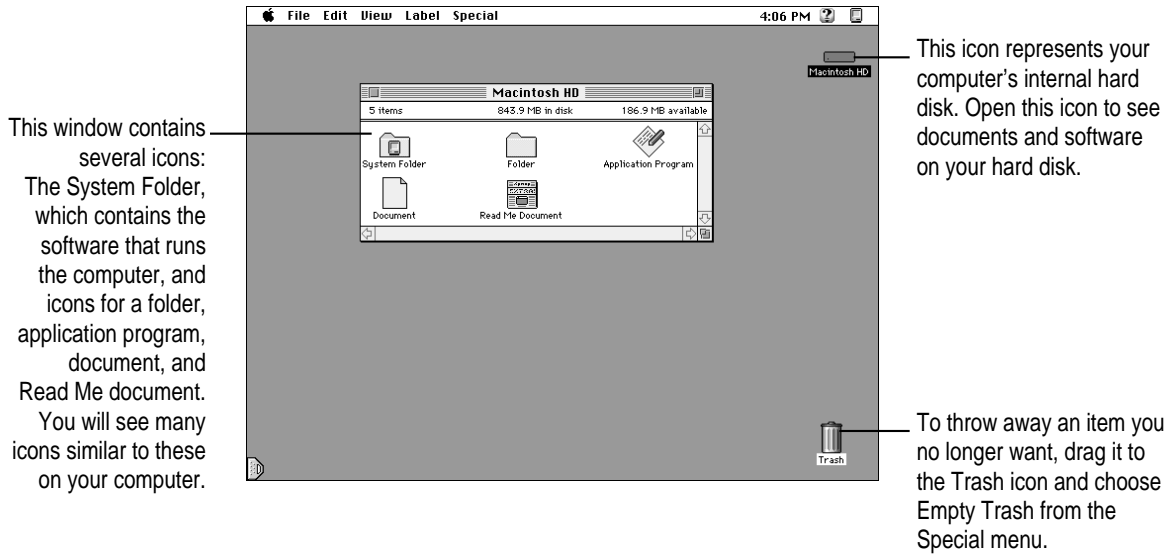

This chapter explains how to get help from the Guide (📖) menu while using the computer, and how to find a tutorial that teaches you about your computer.

2

Learning to Use Your Computer

The Guide menu is your main source of information about your computer. The menu is identified by a question mark (📖) in the upper-right corner of the screen.

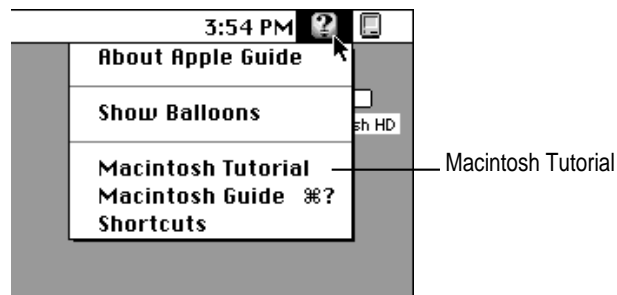

If you are new to the Macintosh, choose Macintosh Tutorial (sometimes called the Mac OS Tutorial) first. The tutorial lets you learn by doing—the fastest way to learn about your computer.

Follow the steps in the next section to choose the tutorial from the Guide menu.

Learning the basics

To start the tutorial, follow these steps:

1 Slide your mouse along your mouse pad or desk.

Hold the mouse as shown, with the cable pointing away from you. Rest the heel of your palm on the desk and grasp the sides of the mouse as shown. Slide the mouse around with the index finger resting on the mouse button. Don't press the mouse button (under your index finger). Notice that the arrow (↖) on the screen moves in the same direction that you move the mouse.

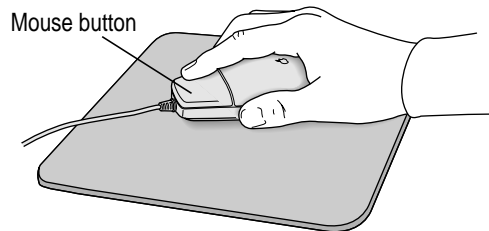

If the arrow doesn't move, make sure that the cables connecting the mouse and keyboard are secure and that your mouse is positioned as shown in the illustration.

2 Move the tip of the arrow (↖) to the question mark (?) in the upper-right portion of the screen.

If you run out of room on your mouse pad or desk while moving the mouse, pick it up and place it where there's more room. (The arrow on the screen moves only when the mouse is in contact with the mouse pad or desk.)

- 3 With the tip of the arrow on the question mark, press and hold down the mouse button.

A list of choices called a *menu* appears. This is the Guide (⌘) menu, which is the place to go when you have a question about how to use your computer.



- 4 While holding down the mouse button, move the arrow until the words “Macintosh Tutorial” are highlighted, then release the mouse button. (On some computers you’ll see Mac OS Tutorial instead of Macintosh Tutorial.)

A window appears welcoming you to the tutorial. You can set this book aside for now and follow the instructions on the screen. When you have completed the tutorial, return to this book and read the next section, “After You Take the Tutorial.”

IMPORTANT You can stop the tutorial at any point and resume it later. If you want to turn off your computer, however, be sure to follow the proper shutdown procedure explained at the end of this chapter.

After you take the tutorial

If you are comfortable with the basic skills taught in the tutorial, you are ready to use your computer. However, you may have additional questions. This book can answer some of them, but there are also many other convenient sources of information. The next section explains how to find answers you need.

Where to find answers

When you have questions about using your Macintosh, there are several places you can look for answers.

Macintosh User's Manual

Use this book to help you set up your computer and learn about it, or to find solutions to problems.



Apple Guide

If you need help or experience a problem while using the computer, open the Guide (⌘) menu and choose Macintosh Guide (or Mac OS Guide). The Guide menu is the main source for information while you are using the computer.

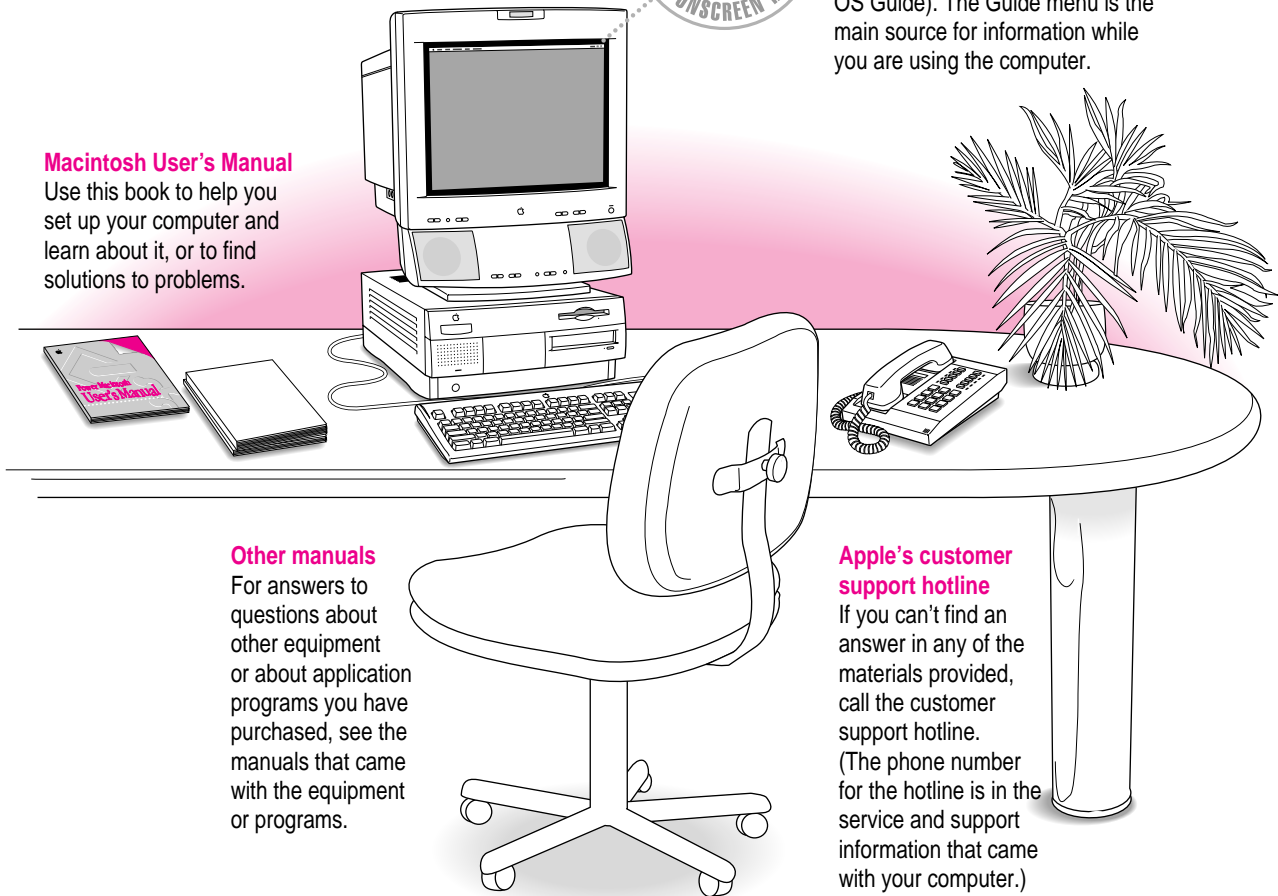

Other manuals

For answers to questions about other equipment or about application programs you have purchased, see the manuals that came with the equipment or programs.

Apple's customer support hotline

If you can't find an answer in any of the materials provided, call the customer support hotline. (The phone number for the hotline is in the service and support information that came with your computer.)

Four simple tips for using Macintosh Guide effectively

1 When you don't see Macintosh Guide (or Mac OS Guide) in the Guide menu
Macintosh Guide (or Mac OS Guide) is only available while you're in the Finder, the system software program that creates and displays your Macintosh desktop. To go to the Finder, do one of the following.

- Click the desktop (the colored or patterned background area of your screen).
- Pull down the Application menu (to the right of the Guide menu) and choose Finder.

2 When you can't find the information you need

- In searching for help topics, use one of the three buttons at the top of the Guide's initial window by clicking them: Topics, Index, and Look For.
- If you're in a series of steps and want to return to the list of help topics, click the Topics button.

3 When you can't see what's behind the Guide window
Guide windows stay in front of other windows on the screen so that your instructions are never covered.

- Drag a Guide window by its title bar to move it out of the way.
- Click the zoom box once to shrink a Guide window. (To expand the window, click the zoom box a second time.)

4 When you need more information about an instruction or term

- Click the "Huh?" button if it is available.

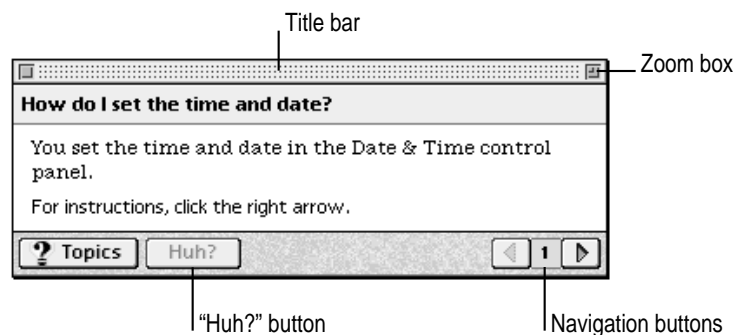

Identifying Objects

If you see something unfamiliar on the screen, open the Guide menu and choose Show Balloons. Then point to the object you want to identify. When you're done, choose Hide Balloons from the Guide menu.

This is an example of balloon help.

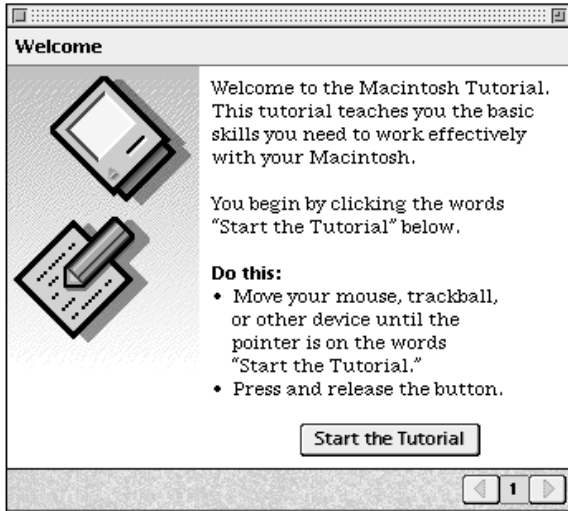

Learning the Basics

To learn basic skills, open the Guide menu and choose Macintosh Tutorial. Then follow the instructions on the screen.

Getting Help via the Internet

If you have an Internet connection, you can get information from the Apple World Wide Web site at <http://www.apple.com>. (For more information about the Internet, see Chapter 6.)

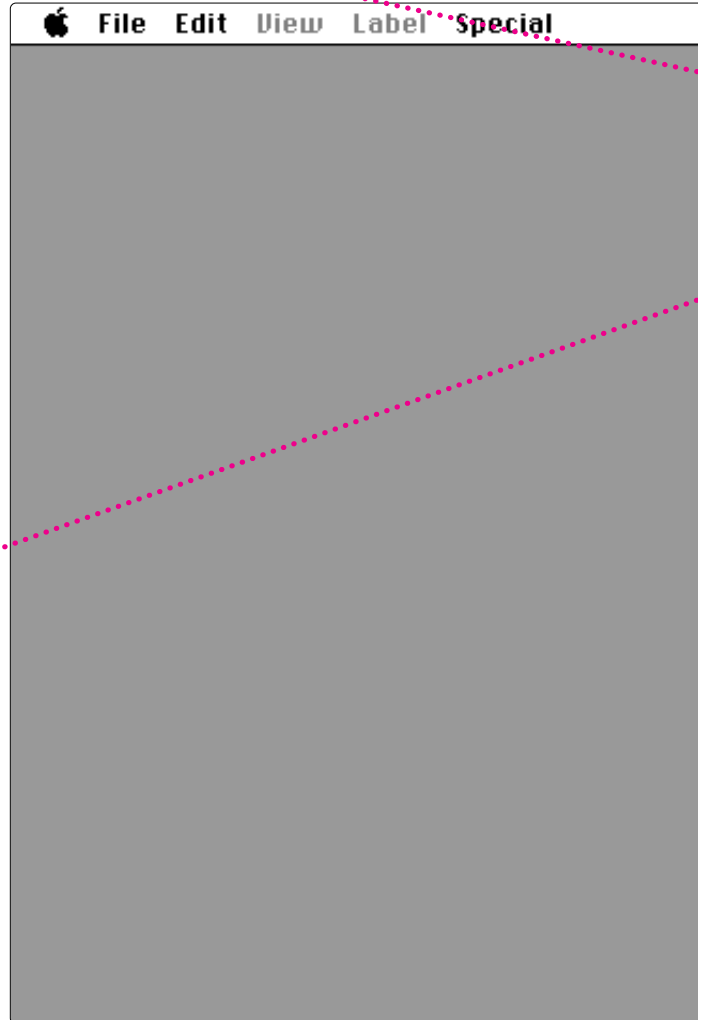



The Guide Menu

To find an answer to a question, look in the Guide (📖) menu—your main source of information about your computer.

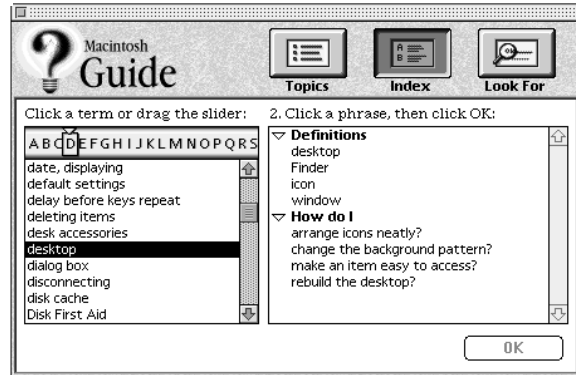
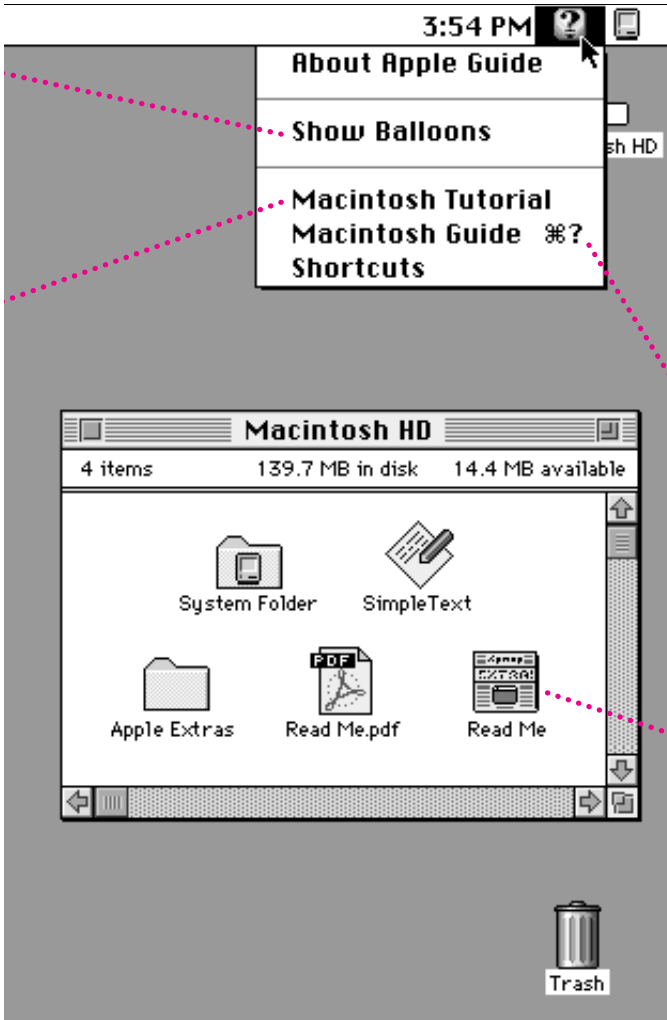

Getting Answers to Your Questions

To get answers to questions you have while working with your computer, open the Guide menu and choose Macintosh Guide (or Mac OS Guide) or a Guide for the program you are using. Then click one of the three buttons at the top of the window: Topics, Index, or Look For, and follow the instructions to choose a subject.

Getting the Latest News

Double-click the hard disk icon to see the “Read Me” file pictured here, which contains last-minute tips and news. Many other Read Me documents are in the Apple Extras folder.

To open a Read Me document that has “pdf” in the icon or in the file name, you first need to install the Adobe Acrobat Reader program, which is available in the Apple Extras folder.

Turning the computer off

To turn your computer off, follow these instructions:

- 1 **Press the Power key (<I>) on your keyboard.**

The following dialog box appears on the screen:

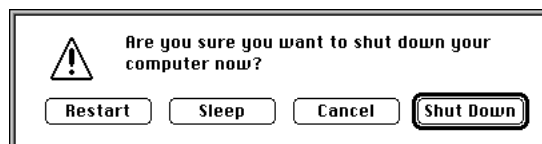

- 2 **Press the Return key on the keyboard (or click the Shut Down button in the dialog box).**

You will be prompted to save any unsaved work before the computer shuts down.

To turn the computer on again, just press the Power key on the keyboard.

Note: In the Finder, you can also turn your computer off by choosing Shut Down from the Special menu.

Read this chapter for information on installing and working with software on your computer.

3

Installing and Using Software



You'll probably want to purchase and install application program software to do specific kinds of work on your computer. Application programs let you, among other things, do word processing; create spreadsheets, databases, and graphics; play games, alone or with others; and explore the Internet.

Your computer includes some basic application programs as well as other software. Some are preinstalled and ready for use. Others are optional; if you want to use them, you must install them first.

This chapter explains how to install and use application programs, and describes the software that came with your computer.

Installing application programs

Most application programs come with an installer that makes it easy to install them on your hard disk. Follow the instructions in the manuals that came with the specific programs to install them. Refer to the general instructions below for additional help on how to use the programs with the Macintosh operating system (Mac OS).

If you have a virus protection program installed, you should turn it off before you install an application program. Also, use the Extensions Manager to turn off system extensions. For more information about Extensions Manager, see “Checking Your System Extensions” in Chapter 11, “Diagnostic Techniques.”

In most cases, you’ll install an application program on your internal hard disk from a CD-ROM disc that contains the program. The illustration below shows how to insert a CD-ROM disc into your computer’s CD-ROM drive, the disc lying flat with the label side up.

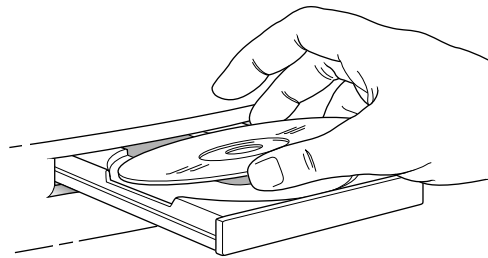

Some application programs come on floppy disks. The illustration below shows how to insert a floppy disk.

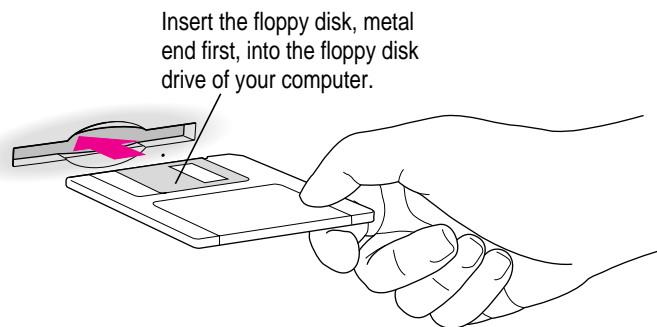

After you insert the disk containing your application program, follow the instructions that came with the program to install it.

To eject a floppy disk or CD-ROM disc after installation is complete, click the disk icon to select it and choose Put Away from the File menu.

IMPORTANT Never copy an entire CD-ROM disc to your hard disk. (Don't drag the disc's icon to your hard disk.) Copying the CD-ROM disc itself can take up a substantial amount of space on your hard disk. When you open programs on some CD-ROM discs, you may get a message telling you to copy or install the program onto your hard disk. If you get this message, refer to the installation instructions that came with the CD-ROM disc, or double-click the CD-ROM disc's icon to open it, and then copy the CD-ROM disc's program to your hard disk.

Installing programs over a network

If your computer is connected to a network, there may be application programs available on the network that you can install. Though you can run installer programs over a network, it is usually faster to first copy the program and its installer onto your computer, and then run the installer to complete the installation. Carefully read any Read Me file or other instructions you find with the program you want to install.

Opening an application program

You open a program the same way you open other items—by double-clicking the program's icon.

When you open a document, the program that created it opens automatically.

Once you are working in a program, you can open other documents in that program by opening the File menu and choosing Open.

Working with several programs at a time

You can open as many application programs and desk accessories as your computer's random-access memory (RAM) allows.

The Application menu in the top-right corner of the screen lists the programs you have open. The name of the active program (the one you're using right now) has a checkmark next to it, and its icon appears in the menu bar.

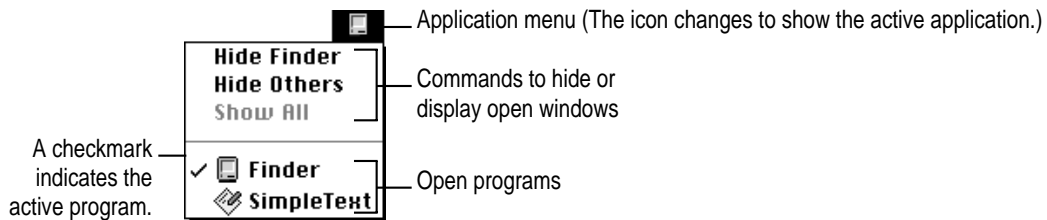

Finding out which programs are open

If you have several programs and windows open, you can find out which program is active and which other programs are open by opening the Application menu.

Switching programs

You can switch to another open program by choosing its name from the Application menu.

If a program's icon is dimmed in the menu, that means its windows are hidden. Choosing the program from the Application menu displays its windows.

You can also switch to another program by clicking in a window that belongs to an open program or by double-clicking a program icon (or the icon of a document that was created with the program).

Hiding and showing windows on the desktop

You can hide all windows except those of the active program by choosing Hide Others from the Application menu. The other programs remain open even though their windows are hidden. When you switch to another program, its windows become visible again.

You can hide the active program by choosing the menu item that has “Hide” next to the program's name in the Application menu. For example, if the Finder is active, you can hide it by choosing Hide Finder from the Application menu.

If you want to see all the open windows, choose Show All from the Application menu.

Five tips for using application programs effectively

- 1 Use “native” Power Macintosh programs.**
 - Your Power Macintosh is compatible with most application programs intended for use with Macintosh computers. But it’s best to use Power Macintosh programs—sometimes called “native” programs—that are designed especially to take advantage of your computer’s PowerPC™ microprocessor.
- 2 Put only one copy of each program on your hard disk.**
 - Having more than one copy can cause errors.
- 3 If you experience problems with a program, try reinstalling.**
 - If a program malfunctions consistently, try installing a fresh copy. If that doesn’t help, find out from the software manufacturer whether your version of the program is compatible with the hardware and system software you’re using.
- 4 Don’t install additional System Folders.**
 - Whenever you copy a program disk to your hard disk, be careful not to copy another System Folder. Your startup disk should only contain one System Folder. Drag any extra System Folders to the Trash.
- 5 Use virtual memory.**
 - If you run out of memory while using Power Macintosh programs, you can use space on your computer’s hard disk as additional memory (called “virtual memory”). For instructions, choose Macintosh Guide (or Mac OS Guide) from the Guide (🔍) menu and read the information under “memory” in the Guide’s index.

You can also add more memory to your computer, as described in Chapter 8, “Installing PCI Expansion Cards and Additional Memory.”

About the software included with your computer

Your computer includes a lot of software. Some of it is preinstalled and ready for use, while other software must be installed before you can use it. The types of software that come with your computer include

- Mac OS operating system software
- Optional system software additions
- Application programs

The following sections provide details about the included software.

Mac OS operating system software

The Mac OS is the basic software that runs the computer itself. It tells the computer what to do when it starts up, keeps track of your documents, files, and other software, and helps your computer find out what devices—such as printers and network cables—are attached to it.

The Mac OS was installed on the internal hard disk at the factory, and starts automatically when you turn on your computer. Here is some of the software that comprises the Mac OS:

- The Finder, which displays the desktop and allows you to organize documents, files, and application programs into folders
- PC Exchange, which lets you work with DOS and Windows disks as if they were Mac OS disks
- QuickTime, which lets you play digital video on your computer
- AppleScript, which allows you to automate tasks in the Finder and other scriptable applications (applications that support AppleScript). Instructions for using AppleScript are in the Apple Extras folder on your hard disk.
- ColorSync, which helps make sure that the colors you see on your monitor closely match the colors you get on printers, scanners, and other devices. For more information about ColorSync, see Macintosh Guide (or Mac OS Guide), available in the Guide (🔍) menu.

IMPORTANT System software is preinstalled on your computer. Do not reinstall system software unless you are experiencing problems or you want to upgrade to a more recent version. Consult Chapter 11, “Diagnostic Techniques,” before attempting to reinstall system software.

Optional system software additions

Your computer includes optional software that adds other capabilities to the Mac OS. This software was not installed at the factory, so you have to install it if you want to use it.

Tip: Some of this software can decrease the amount of memory available for use by programs. To conserve memory, only install the software you think you'll use.

These are some of the optional system software additions included with your computer:

- OpenDoc, which extends the usefulness of your applications by adding new functionality in the form of self-contained software components, or “parts.” A variety of parts will be available from both Apple and third-party sources, including parts for placing Internet resources directly into documents.
- QuickDraw GX, which gives your computer more powerful printing capabilities
- QuickDraw 3D, which gives your computer the ability to display graphics in three dimensions
- PlainTalk, which allows your computer to understand spoken commands in English and Mexican Spanish
- Apple VideoPhone software, which allows you to set up video conferences and collaborate over a network

To see what is included with your computer, look in the Apple Extras folder on your hard disk and in the CD Extras folder on the CD-ROM disc that came with your computer. There is usually a Read Me file that explains each system software addition in more detail. To install one of these items, look for an Installer icon, similar to the one below, for the software. Double-click the Installer and follow the instructions that appear.



Application programs

Your computer comes with application programs to play QuickTime videos, to play audio CDs in your CD-ROM drive, and to open HyperCard stacks. It also includes Internet access programs such as the Apple Internet Connection Kit.

To see what's available, look on your hard disk and on the CD-ROM disc that came with your computer. Some of the programs are preinstalled, while others must be installed before you can use them. To install one of these items, look for an Installer icon for the program. Double-click the Installer and follow the instructions that appear.

If you have questions about using an application program, refer to the Read Me file for the program, which is usually found inside the program's folder. Some programs also have online help that you can access after you have installed the program. Look for online help in the Guide (⌘) menu after you start the program.

For more information about the Apple Internet Connection Kit, see Chapter 6, "Using an Online Service or the Internet."

Backing up your files

Making backup copies of important files is good protection against possible damage to the originals.

- You can back up files stored on your hard disk by copying them to floppy disks.
- You can back up an entire floppy disk by copying it to another floppy disk of the same capacity or larger, or by copying it to a hard disk.
- You can use a commercial backup program to copy new and changed files from a hard disk to another hard disk, a tape drive, a series of floppy disks, or to another form of removable media.
- If your computer is on a network, you may be able to back up files by copying them to a shared disk on the network.

Communicating With Other Computers

Chapter 4 Connecting Your Computer to a Telephone Line

Chapter 5 Connecting Your Computer to a Network

Chapter 6 Using an Online Service or the Internet



II
part

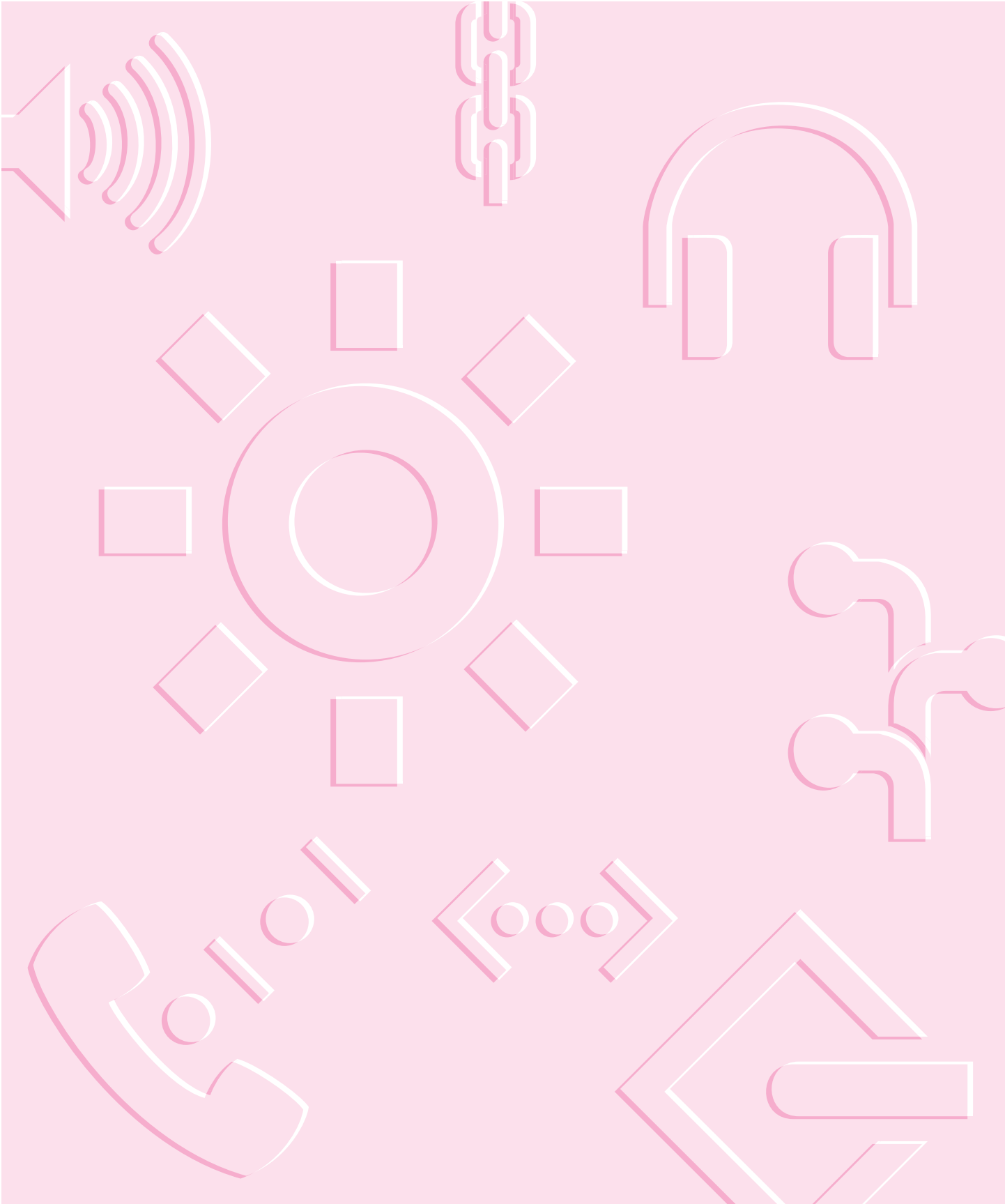

Read this chapter for information about the equipment you need to get online, such as modems and ISDN lines.

4

Connecting Your Computer to a Telephone Line



A world of information is now available online. By connecting your computer to a telephone line, you can access the Internet, send and receive electronic mail (“e-mail”) and faxes, and connect to online services like America Online and CompuServe. You can also use a telephone line to access another Macintosh or an entire AppleTalk network from a remote Macintosh computer. (For example, you can telecommute by accessing a company computer network from a remote location, such as a home office.)

To get online, you need special equipment and software. This chapter provides a brief introduction to the equipment you need. For information about the software you need to perform online tasks, see Chapter 6, “Using an Online Service or the Internet.”

Types of equipment

There are three types of equipment you can use to get online: a modem, an ISDN line, and shared telecommunications equipment on your network.

Modem: A modem may be the most common way to connect a computer to a phone line, particularly if you are using your computer at home. A modem works with standard analog telephone lines. For more information about modems, see the next section, “Choosing and Connecting a Modem.”

ISDN line: An Integrated Services Digital Network (ISDN) line is a special digital phone line that is about four times faster than the fastest modem used over a standard analog telephone line. However, an ISDN line typically costs more than regular phone service and may not be available in your community. For more information about ISDN, see “Connecting to an ISDN Line” later in this chapter.

Shared telecommunications equipment on your network: One of the advantages of networks is that you can share equipment, such as printers and file servers. If your computer is one of many linked together in a network, there may also be shared communications equipment connected to your network that will allow you (or anyone else on your network) to get online. Contact your computer network administrator for more information. You can also find general information about networks in Chapter 5, “Connecting Your Computer to a Network.”

Choosing and connecting a modem

A modem is a piece of equipment that turns the data from your computer into information that can be transmitted over telephone lines. The modem enables your computer to send and receive telephone calls, to connect to the Internet, to access online services, and to communicate with other computer users. Some modems also allow you to transmit documents on your computer to fax machines as well as receive faxes as documents that you can view on screen or print.

Keep in mind that when your phone and a modem share a single phone line, you will not be able to use both at the same time, even if they are attached to separate phone jacks. While you use a modem, outside callers get a busy signal and you cannot call out. Conversely, when you use your phone, you cannot use the modem. (If you miss phone calls because you often use your modem, you may want to get a second phone line installed or get a phone company message service which, unlike an answering machine, will record messages even when your phone is off the hook or you are online.)

Also keep in mind that long-distance charges accrue when your modem dials long-distance numbers. In most cases, an online service or an Internet service provider will have a local access phone number so that long-distance charges do not apply.

Choosing a modem

When selecting a modem, look for one with fast data-transfer speed, a compatible modem cable, and good bundled software.

Data-transfer speed

The data-transfer speed determines how fast a modem can move data between your computer and other computers. Purchase the fastest modem that you can afford, particularly if you plan to connect to the World Wide Web. Many Web pages contain graphics, video, and sound files that will take longer to *download* (copy onto your computer) with a slower modem.

The data-transfer speed of a modem is specified in kilobits per second (kbps) or bits per second (bps). Faster modems transfer data to and from your computer more quickly than slower ones. The following table describes the current modem speeds that are available.

Modem speed	Usage
33,600 bps (33.6 kbps)	The fastest modem available (as of this writing) for use with standard analog telephone lines. Suitable for World Wide Web use.
28,800 bps (28.8 kbps)	Slightly slower than a 33.6 kbps modem, but still very suitable for World Wide Web use.
14,400 bps (14.4 kbps)	Only half as fast as a 28.8 kbps modem. May be acceptable for text-oriented applications such as e-mail or terminal emulation.
9600, 4800, and 2400 bps	Too slow for most purposes.

Modem cable

If you purchase a modem that is designed for use with a Macintosh, it will probably include a Macintosh-compatible modem cable. If you have to purchase a cable separately, make sure it supports *hardware handshaking*, a protocol that controls the flow of data between computers. Also, check to make sure the cable has a rounded connector that will fit the modem port on the back of your computer (labeled with a  icon). A cable designed for use with a Windows- or DOS-compatible computer won't work with your Macintosh.

Bundled software

Many modems include bundled software, such as fax software, a terminal emulation program, and free trial membership software for online services. If you can't decide between two comparatively priced modems, pick the one that comes with the best bundled software.

Connecting a modem

To connect a modem, follow the instructions in the manuals that came with your modem.

Note: Some modem models have a single phone jack, while others have two. If your modem has only one phone jack, consider purchasing a line splitter at an electronics supply store. A line splitter enables you to plug your phone and your internal modem into the same jack at the same time. (By the way, you can keep your answering machine connected to your phone, even if your phone and modem share the same telephone line.)

IMPORTANT When connecting a modem, make sure you connect the modem to an analog phone line—the kind used typically in homes. Connecting to an ISDN line could damage the modem.

IMPORTANT Disconnect your modem from the phone jack during lightning storms. This will prevent a destructive voltage overload from damaging the modem.

Connecting to an ISDN line

If you have a home office, telecommute frequently, or routinely need to send and receive large files, then a 28.8- or 33.6-kbps modem may not be fast enough for your needs. For faster performance, you may want to consider connecting your computer to an Integrated Services Digital Network (ISDN) digital telephone line, which can transfer data at 128 kbps, nearly 4.5 times faster than a 28.8-kbps modem.

ISDN lines are available to most but not all residential and business telephone customers. Check with your local phone company to see if ISDN service is available at your location.

There are fixed monthly charges and per-minute usage fees for ISDN, just like regular phone service. Typically, ISDN costs more than regular phone service, but it is still affordable for many business and residential purposes. Because one ISDN line can support several devices simultaneously—such as a computer, voice phone, and fax machine—you may be able to replace existing extra phone lines with one ISDN line.

Note: Because an ISDN line requires a power source at your location, a phone attached to an ISDN line will not work during a power outage. For emergency use, you should strongly consider keeping your regular analog phone line, which receives power from the phone company.

Setting up an ISDN line

If you're interested in setting up an ISDN line, first contact your local phone company to see if ISDN service is available at your location. Your phone company can also provide specific information about monthly charges and usage fees. (Your phone company may also charge an installation fee, which may be waived or refunded if you agree to keep the ISDN line for a specified amount of time.)

In addition, you also need to purchase and configure an ISDN terminal adapter, which connects to the external modem port on your Macintosh and to the ISDN line. (ISDN terminal adapters are often called “ISDN modems” because they are somewhat similar to modems.)

Some ISDN terminal adapter models may be difficult to configure with the network configuration of your employer or Internet service provider (ISP). Work closely with your computer network administrator or ISP to make sure you purchase a compatible ISDN terminal adapter.

Read this chapter for information on physically connecting and configuring your computer to work on a network.

5

Connecting Your Computer to a Network



Your Macintosh has built-in networking ports so that you can connect it to a network that consists of as few as two computers or as many as thousands or even millions of computers and other devices. The network allows you and the other people connected to it to share information, access remote services, and share computing resources such as printers and modems.

A network extends the features of your Macintosh by extending your reach to the services and resources provided on the network. For example, by itself, your computer lets you store, retrieve, and modify information on hard disks and floppy disks. On a network, however, you can also store and retrieve information on servers, access information that other people have stored on their computers, and use electronic mail and other network services.

You can connect your Macintosh to a LocalTalk network and to a high-speed Ethernet network. You can also purchase peripheral component interconnect (PCI) cards for alternative networks such as TokenRing, ISDN, and Fiber Distributed Data Interface (FDDI).

This chapter describes how to connect to and configure your computer on LocalTalk and Ethernet networks. Refer to the appropriate information source for other network-related information:

- If your computer is already connected to a network, refer to Macintosh Guide (or Mac OS Guide), available in the Guide (📖) menu, for information about printing on a networked printer, accessing information on file servers, and sharing files on your computer with other users. Also, your network administrator can provide information about network software that may be available, such as Internet access and electronic mail.
- If your location does not currently have a network and you are interested in setting one up, you should refer to a book on Macintosh networking that will help you select and plan a network that is appropriate for your organization. Many books are available, such as *Planning and Managing AppleTalk Networks*, an Apple book published by Addison-Wesley that is available at computer bookstores.



Connecting to a LocalTalk network

To connect your Macintosh to a LocalTalk network, you will need LocalTalk cables and a LocalTalk adapter. In most cases, the Apple LocalTalk Locking Connector Kit DIN-8, available from your Apple-authorized dealer, contains the components you need to connect your Macintosh to an existing LocalTalk network. If your network uses standard telephone cables for your network wiring, obtain an Apple LocalTalk RJ-11 Connector instead.

Apple LocalTalk Locking Connector Kit DIN-8

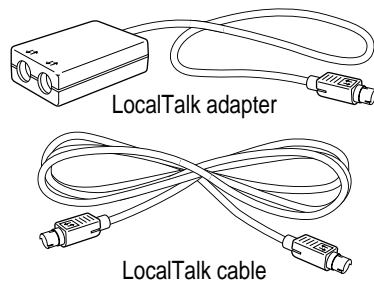

Apple LocalTalk RJ-11 Connector

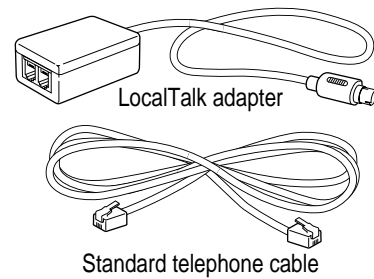

Note: At your location, there may be a network administrator who is responsible for network maintenance and upkeep. If so, ask your network administrator to help connect your computer to the network.

To connect your Macintosh to a LocalTalk network, do the following:

- 1 **Shut down your Macintosh.**
- 2 **Attach the LocalTalk adapter to the printer port on your computer.**

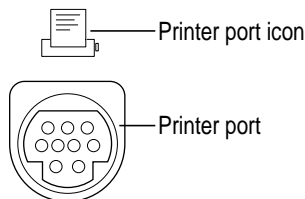

- 3 **Attach a network cable between the LocalTalk adapter connected to your computer and the last LocalTalk adapter on your existing network.**

Use the LocalTalk cable that comes with the Apple LocalTalk Locking Connector Kit DIN-8. Use a standard telephone cable with RJ-11 connectors if you are using the Apple LocalTalk RJ-11 Connector.

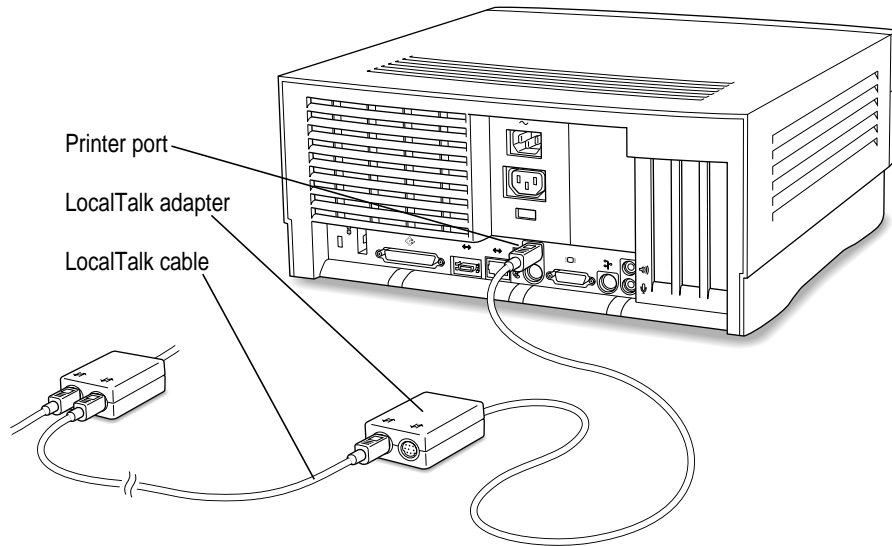

Next, see “Configuring Your Network Connection” later in this chapter for information on configuring your LocalTalk connection.

Connecting to an Ethernet network

The built-in Ethernet capabilities of your Macintosh allow you to connect to any standard Ethernet network using 10Base-T twisted-pair cables, thin or thick coaxial cables, fiber-optic media, or other standard Ethernet cables.

You can connect *directly* to an Ethernet network that uses 10Base-T twisted-pair cable. To connect your Macintosh to an Ethernet network that uses coaxial cables, you need one of the following Ethernet media adapters:

- Apple Ethernet Thin Coax Transceiver
- Apple Ethernet AUI Adapter

See your Apple-authorized dealer for more information on Apple Ethernet media adapters. Refer also to the following instructions for information on which items to purchase.

WARNING Do not connect cables to the back of your computer when the computer is on or you may damage your system.

You can connect an adapter and cable for an Ethernet network directly to the computer without installing an expansion card. You can find the Ethernet ports on the back of your Macintosh by looking for the Ethernet icon:

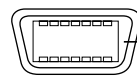

AAUI Ethernet port

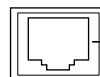

10Base-T Ethernet port

Although you can connect cables to both of these Ethernet ports at the same time, only one of the ports will be active. For more information, see “Connecting to Multiple Networks Simultaneously” later in this chapter.

Note: At your location, there may be a network administrator who is responsible for network maintenance and upkeep. If so, ask your network administrator to help connect your computer to the network.

Connecting to a twisted-pair Ethernet network

Follow this procedure to connect your Macintosh to an Ethernet network that uses twisted-pair cable. The hardware connection requires a twisted-pair patch cord with an RJ-45 telephone-style connector. You plug the patch cord into a standard wall plate that is connected to a centralized 10Base-T hub.

To connect your Macintosh to a twisted-pair network:

- 1 Shut down your Macintosh.**
- 2 Plug one end of the twisted-pair patch cord into the 10Base-T Ethernet port on your Macintosh.**
- 3 Plug the other end of the twisted-pair patch cord into an RJ-45 wall outlet that is connected to a twisted-pair Ethernet network.**

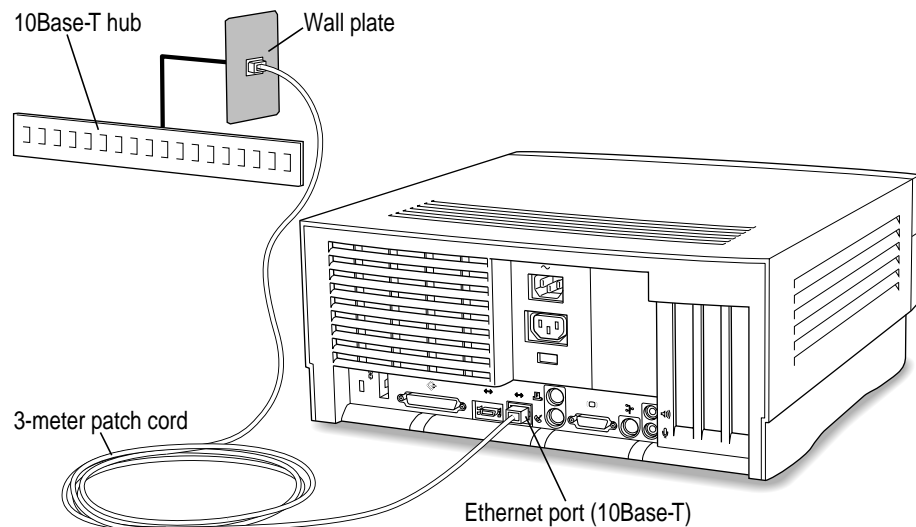

Next, see “Configuring Your Network Connection” later in this chapter for information on configuring your network connection.

Connecting to a thin coaxial Ethernet network

Follow this procedure to connect your Macintosh to an Ethernet network that uses thin coaxial cable. The hardware connection requires an Apple (or Apple-compatible) thin coaxial transceiver and a thin coaxial cable.

IMPORTANT You can connect your Macintosh anywhere along a network; however, to do so requires that you temporarily disconnect the network, which could disrupt existing network services and other people using the network. Consult your network administrator before connecting your computer to the network.

To connect your Macintosh to a thin coaxial network:

- 1 Shut down your Macintosh.**
- 2 Attach one end of a thin coaxial cable to the last thin coaxial transceiver on the network.**
- 3 Attach the other end of the thin coaxial cable to one of the connectors on the thin coaxial transceiver.**

4 Plug the connector on the transceiver into the AAUI Ethernet port on your Macintosh.

A thin coaxial network must be terminated at the endpoints to function. An Apple transceiver is self-terminating. A non-Apple transceiver may require a terminator; check the documentation that came with the transceiver.

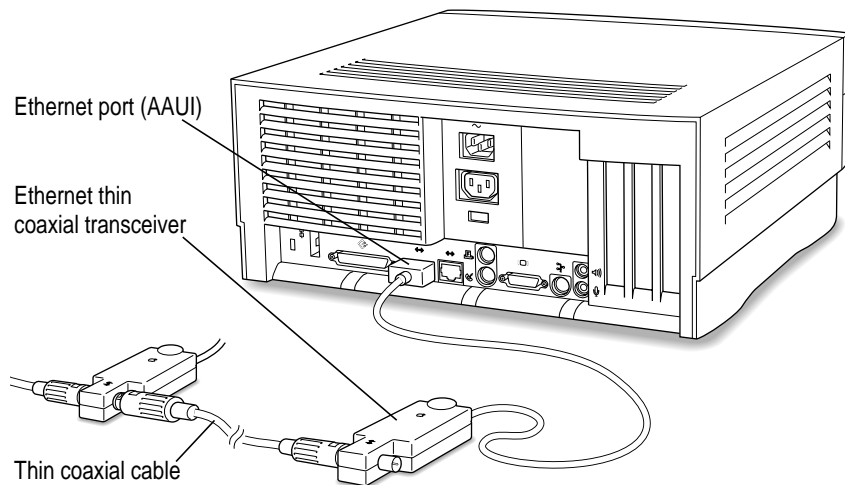

Next, see “Configuring Your Network Connection” later in this chapter for information on configuring your network connection.

Connecting to other types of Ethernet networks

The Apple Ethernet AUI Adapter is a universal adapter that lets you connect your Macintosh to less-common types of industry-standard Ethernet media, such as thick coaxial or fiber-optic cable. If you are using the Apple Ethernet AUI Adapter, you also need an Ethernet transceiver for your specific media type; the transceiver must have a standard AUI port on it.

To connect your Macintosh to an Ethernet transceiver for other types of Ethernet media:

- 1 Shut down your Macintosh.**
- 2 Connect the Ethernet transceiver to the network following the instructions that came with the transceiver.**
- 3 Plug the transceiver cable from the Ethernet transceiver into the standard AUI port on the Apple Ethernet AUI Adapter.**

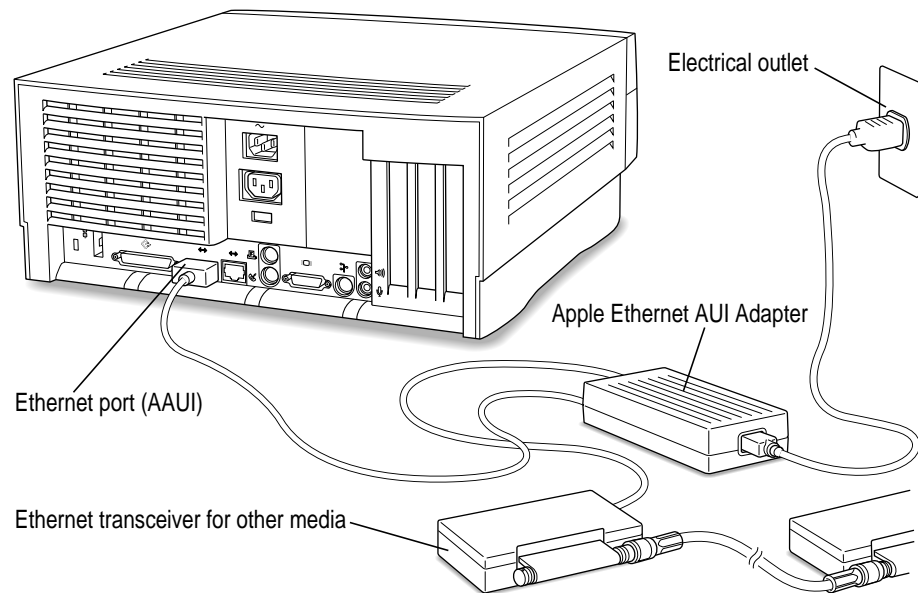

- 4 Plug the adapter's power cord into an electrical power outlet.**
- 5 Plug the connector on the Apple Ethernet AUI Adapter into the AAUI Ethernet port on your Macintosh.**

Next, see “Configuring Your Network Connection” later in this chapter for information on configuring your network connection.

Connecting to multiple networks simultaneously

Because your Macintosh has three networking ports—LocalTalk, AAUI Ethernet, and 10Base-T Ethernet—it is possible to be physically connected to more than one kind of network at the same time. However, you can use only one of your connections at one time.

If both 10Base-T and AAUI networks are connected, your Macintosh automatically uses the 10Base-T connection. You cannot use the AAUI connection unless you physically disconnect the 10Base-T connection.

If you are connected to both a LocalTalk and an Ethernet network (either 10Base-T or AAUI), your computer uses the Ethernet connection unless you specify LocalTalk in the AppleTalk control panel. “Configuring Your AppleTalk Network Connection” in the section “Configuring Your Network Connection” (next) explains how to specify the port you want to use.

Configuring your network connection

After you physically connect your computer to a LocalTalk or Ethernet network, you need to configure your network connection in the AppleTalk control panel, the TCP/IP control panel, or both.

You use the AppleTalk control panel to set up your connection to an AppleTalk network (that is, a network using the AppleTalk protocol).

You use the TCP/IP control panel to set up your connection to the Internet and to a TCP/IP network. TCP/IP stands for Transmission Control Protocol/Internet Protocol, a standard system for connections between computers of different types.

You may need additional information about the network to which your computer is connected, or about the service through which your computer is connected to the Internet. To get this information, you may need to contact your network administrator or your Internet service provider.

Configuring your AppleTalk network connection

To configure your AppleTalk network connection, you must specify the port you use to connect your computer to the network.

Larger networks use zones to create logical groupings of computers, printers, servers, and other network devices. For example, a network might have a zone for each floor in a multistory office building. If your network has more than one zone, you can choose the zone in which your computer is located. The zone you choose is the zone that is automatically selected in the Chooser (for example, when you select a network printer) and it is the zone in which other network users can find your computer if you turn on file sharing.

To configure your AppleTalk network connection, follow these steps:

- 1 **Choose Control Panels from the Apple () menu.**
- 2 **Double-click the AppleTalk icon to open it.**

The AppleTalk control panel opens.

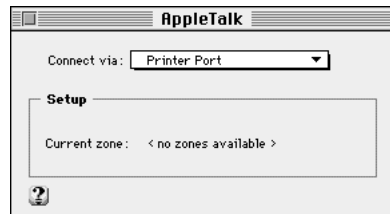

- 3 **Use the “Connect via” pop-up menu (if available) to choose the port through which your computer is connected to the network.**

You can connect to an AppleTalk network through an Ethernet port, the printer port, the modem port, or any additional ports available on expansion cards installed in your computer. (Any additional ports appear automatically in this pop-up menu.)

Note: If you don't see a pop-up menu here, this setting has been locked. Contact your network administrator for assistance. (If you don't have a network administrator, you can use the Administration user mode to unlock this setting. For more information about user modes, click the  button in the AppleTalk control panel.)

4 Use the Current Zone pop-up menu (if available) to choose the zone you want.

If you don't see a pop-up menu here, this setting has been locked or your network is not set up to allow you to choose a zone. Zones are set up by the network administrator.

5 Click the close box to close the AppleTalk control panel.

If you have made configuration changes, an alert box asks if you want to save them. If you have changed the port, an alert box also tells you that the change will interrupt any AppleTalk services that are established. This means that your network services such as printers and e-mail may be temporarily unavailable, and you may have to choose a printer and log on to your e-mail again after saving changes.

6 To save your changes, click the Save button.

Your changes take effect immediately; you do not have to restart your computer.

Getting more information about the AppleTalk control panel

Macintosh Guide (or Mac OS Guide) contains information about additional capabilities available in the AppleTalk control panel, such as:

- using configurations, a way to save different AppleTalk settings and switch among them as desired—for example, if you use your computer with more than one network
- using the User Mode command to change the availability of settings in the AppleTalk control panel
- turning AppleTalk off in order to save RAM in your computer when you are not using an AppleTalk network

For more information about these capabilities, click the  button in the AppleTalk control panel.

Configuring your TCP/IP network connection

You use the TCP/IP control panel when your computer is connected to a network that uses TCP/IP standards, such as the Internet.

TCP/IP (Transmission Control Protocol/Internet Protocol) is a standard set of rules (or protocols) for making connections among different types of computers. TCP/IP protocols can be used with many different types of network hardware, including LocalTalk, Ethernet, and dialup Internet connections. If you don't know whether your network uses TCP/IP, contact your network administrator.

To set up your TCP/IP network connection, you must specify the port you use to connect your computer to the network. TCP/IP networks also require information about your computer's network address. You must enter that information in the control panel, or specify a server on which the information can be found.

Before you begin

To use a TCP/IP network, your computer must have an IP (Internet Protocol) address, and it often must have a subnet mask number. Your network address and subnet mask number identify your computer's location on the network. This information can be entered manually or obtained automatically from a server. Before you set up your TCP/IP network connection, obtain your IP address and subnet mask number from your Internet service provider or network administrator. If these can be obtained automatically from a server, find out whether the server is a "BootP," "RARP," "DHCP," or "MacIP" server.

"BootP" stands for *Boot Protocol*. A BootP server can automatically provide all the TCP/IP setup information you need.

"RARP" stands for *Reverse Address Resolution Protocol*. A RARP server can provide the IP address for your computer, but you must provide the rest of the information manually.

"DHCP" stands for *Dynamic Host Configuration Protocol*. A DHCP server can automatically provide all the TCP/IP setup information you need.

“MacIP” stands for *Macintosh Internet Protocol*. MacIP is both a type of server and a protocol for sending Internet-type packets of information over an AppleTalk network. A MacIP server can provide all the TCP/IP setup information you need, but you need to know the zone where the MacIP server is located.

Setting up

To set up your TCP/IP network connection, follow these steps:

- 1 **Choose Control Panels from the Apple () menu.**

The Control Panels window opens.

- 2 **Double-click the TCP/IP icon to open it.**

The TCP/IP control panel opens.

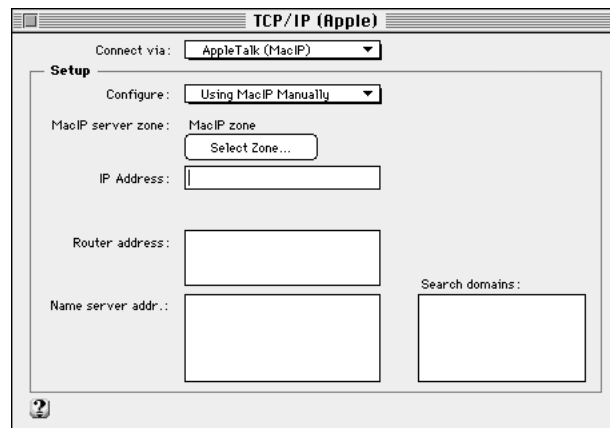

- 3 **Use the “Connect via” pop-up menu to choose the port through which your computer is connected to the network.**

Note: If you don’t see the pop-up menu here or other settings described in this section, they may have been locked. Contact your network administrator for assistance. (If you don’t have a network administrator, you can use the Administration user mode to unlock this setting. For more information about user modes, click the  button in the TCP/IP control panel.)

4 Use the Configure pop-up menu to choose a configuration method.

If you are connected using Ethernet, the pop-up menu looks like this:

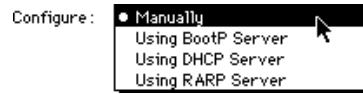

If you are connected using AppleTalk (MacIP), the pop-up menu looks like this:

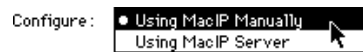

What you do next depends on whether you are configuring your network manually or automatically.

5 If you are configuring your network connection manually, type the information provided by your network administrator or Internet service provider into the appropriate boxes.

You must specify an IP address. You may also need to enter a subnet mask number, router address, and other information.

6 If you are configuring your network connection automatically, do one of the following:

- If you are using a BootP server or DHCP server, skip ahead to step 7. The server usually provides all the configuration information needed by TCP/IP.
- If you are using a RARP server, you may need to type additional information provided by your network administrator or Internet service provider into the appropriate boxes. If so, enter the information now.
- If you are using a MacIP server, click Select Zone. In the dialog box that appears, choose the zone that contains the MacIP server you want to use and then click OK.

7 Click the close box to close the TCP/IP control panel.

If you have made configuration changes, an alert box asks if you want to save them. If you have changed the port, an alert box also tells you that the change will interrupt any TCP/IP services that are established. For example, you may have to quit and reopen a Web browser or e-mail software after saving changes.

8 To save your changes, click the Save button.

Your changes take effect immediately; you do not have to restart your computer.

Getting more information about the TCP/IP control panel

Macintosh Guide (or Mac OS Guide) contains information about additional capabilities available in the TCP/IP control panel, such as:

- using configurations, a way to save different TCP/IP settings and switch among them as desired
- using the User Mode command to change the availability of settings in the AppleTalk control panel
- turning TCP/IP off to save RAM when you are not using a TCP/IP network

For more information about these capabilities, click the  button in the TCP/IP control panel.



Read this chapter for information about the Internet and online services software that is included with your computer.

6

Using an Online Service or the Internet



You can use your Macintosh to join the fastest growing organization on Earth: the online community. By connecting your computer to an online service or the Internet, you can exchange electronic mail (“e-mail”) messages, gather information on topics of interest, participate in discussion groups, download software, and use many other services.

Your Macintosh computer includes software that you can use to connect to an online service or the Internet. This chapter describes the software and provides a brief introduction to the information and services that are available online.

In addition to the included software, you need special equipment, such as a modem, to get online. For more information about the equipment you need, see Chapter 4, “Connecting Your Computer to a Telephone Line.”

Connection software

Your Macintosh comes with two different application programs that you can use to get online: America Online and the Apple Internet Connection Kit. Although both programs provide Internet access, they have different features; you can use the one that best addresses your needs.

America Online

America Online (AOL) is an online service; in addition to Internet access, America Online provides many exclusive information services that may not be available on the Internet. AOL is also very easy to use, and may be the best choice if you have never used an online service or the Internet before. For more information about AOL, see its folder on your hard disk or on the CD that came with your computer.

Apple Internet Connection Kit

The Apple Internet Connection Kit is a collection of Apple and third-party software that lets you connect to the Internet quickly and easily. The kit includes the Netscape Navigator Web browser, Claris EMailer Lite e-mail software, and several other Internet applications and utilities. For more information, see the *Apple Internet Connection Kit: Getting Started* manual that came with your computer. If you decide to use the kit, your best source of help is the Apple Internet Connection Kit Guide, available in the Guide (🔍) menu when you're using the kit's software.

Note: To connect to the Internet by modem using the Apple Internet Connection Kit, you need an Internet service provider (ISP). You pay the ISP to use their access to the Internet, much as you pay the phone company for access to the telephone network.

What you can do online

You can usually do the following through an online service or the Internet.

Exchange electronic mail

You use e-mail to exchange messages. You can create, read, and respond to e-mail. Unlike paper mail, you can conveniently send the same e-mail message to a group of recipients. You can also subscribe to e-mail distribution lists that provide information on topics of interest to you.

Access the World Wide Web

The World Wide Web is the fastest growing part of the Internet. Many organizations post information on Web “pages” that you can view with software called a Web browser. A portion of the Apple Computer “home page” is shown below.



A Web page usually contains words or pictures that serve as links to other information; you click these links to display related information. There are Web pages available on every imaginable subject, providing news, information, and entertainment. You can search the Web to find information on topics of interest.

Some online services and companies that provide Internet access will even set aside some space for you to make your own Web page available.

Download files

You can retrieve pictures, sound files, movies, text documents, utilities, and application software at a minimal cost (and often at no cost at all). Although Apple Computer, Inc., does not provide technical assistance with non-Apple software you download, the software's creators may provide technical support.

Join a discussion group

Discussion groups are forums where people with common interests openly exchange information by writing messages. On the Internet, these discussion groups are called *Usenet newsgroups*. Like Web pages, Usenet newsgroups address nearly every subject imaginable. Topics range from stamp collecting to nuclear physics to cooking.

Expanding Your Computer's Capabilities

Chapter 7 Connecting Additional Equipment

Chapter 8 Installing PCI Expansion Cards and Additional Memory

III
part



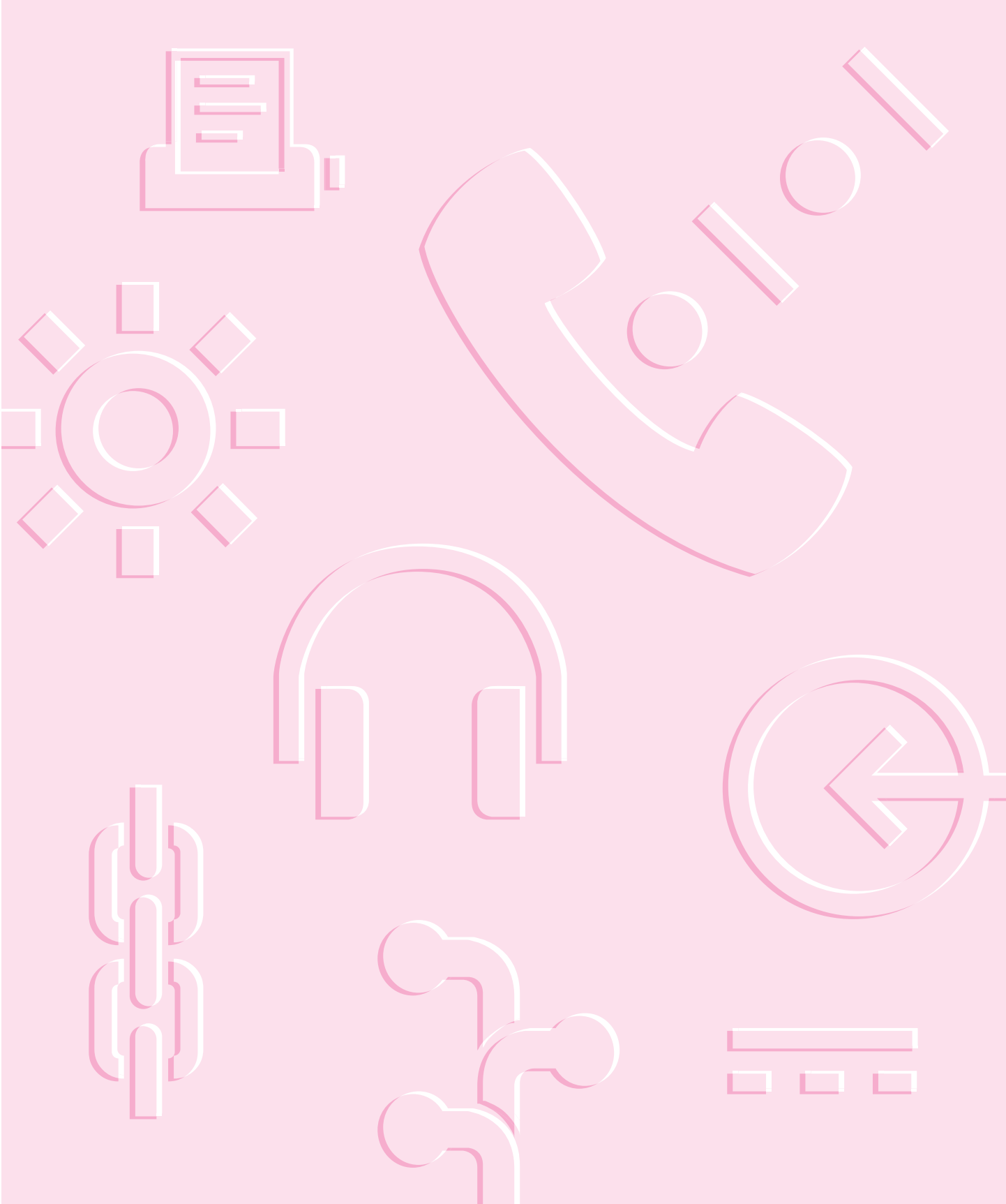

This chapter describes how to connect additional equipment such as a printer, second monitor, input device, or audio device.

7

Connecting Additional Equipment



You can expand your computer system by connecting other equipment to it. The illustrations on the next two pages show where equipment connects to your Macintosh.

This chapter describes how to connect the following types of devices:

- audio equipment, such as a microphone, headphones, or speakers
- external SCSI devices, such as a hard disk and a cartridge drive
- a printer
- a second monitor
- additional ADB input devices, such as a trackball or a graphics tablet
- security equipment to protect your Macintosh

For instructions on installing internal equipment, see Chapter 8, “Installing PCI Expansion Cards and Additional Memory.” For instructions on connecting to a network, see Chapter 5, “Connecting Your Computer to a Network.”

IMPORTANT Each device you add should be compatible with your computer and must not exceed the maximum power allowance for that device. Turn off the computer before connecting a SCSI or ADB device. For more information, consult an Apple-authorized dealer, the manufacturer of the equipment you add, or the *Technical Information* booklet that came with your computer.

Your Computer's Components and Front Panel Controls

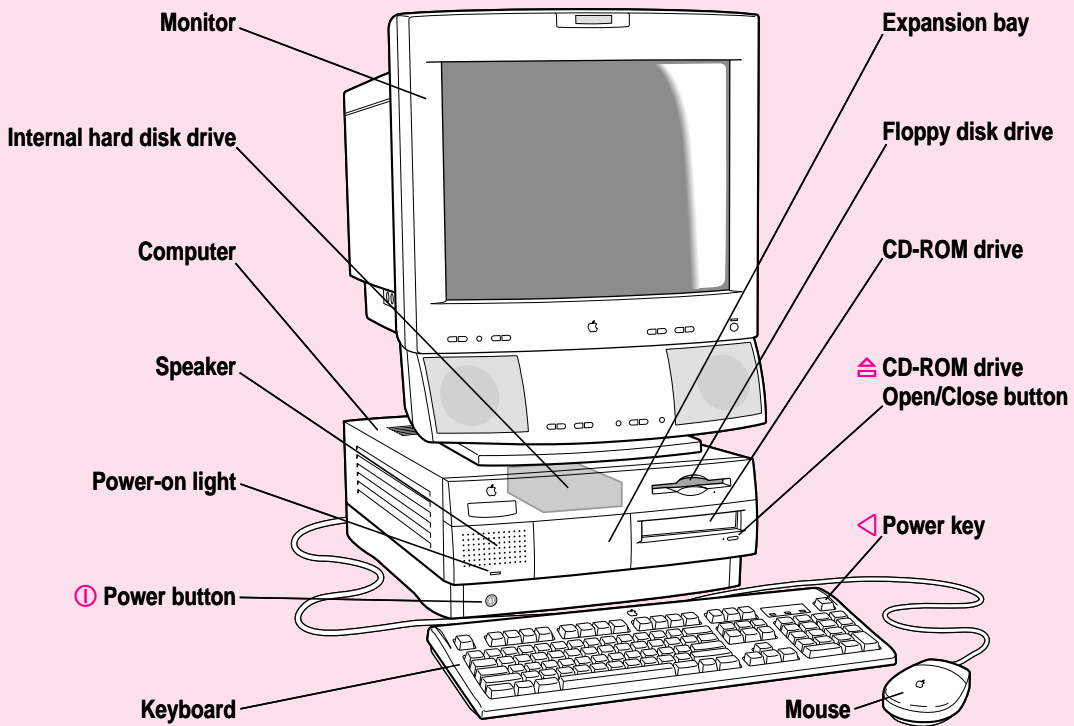

Monitor

Your monitor may look different. An AppleVision AV Display with a built-in microphone and stereo speakers is shown here.

Internal hard disk drive

Large-capacity permanent device for storing software, documents, and other files

Power-on light

A green light indicates that the computer is on.



Power button

Turns your computer on or off when you can't use the Power key on the keyboard or the Shut Down command

Expansion bay

Behind the front panel there is an expansion bay for an optional 3-1/2" storage device (1.625" [41.3 mm] high).

Floppy disk drive

Works with high-density and double-sided 3.5" (89 mm) floppy disks

CD-ROM drive

Works with CD-ROM discs and plays standard audio and Photo CDs



**CD-ROM drive
Open/Close button**

Opens and closes the CD-ROM drive tray











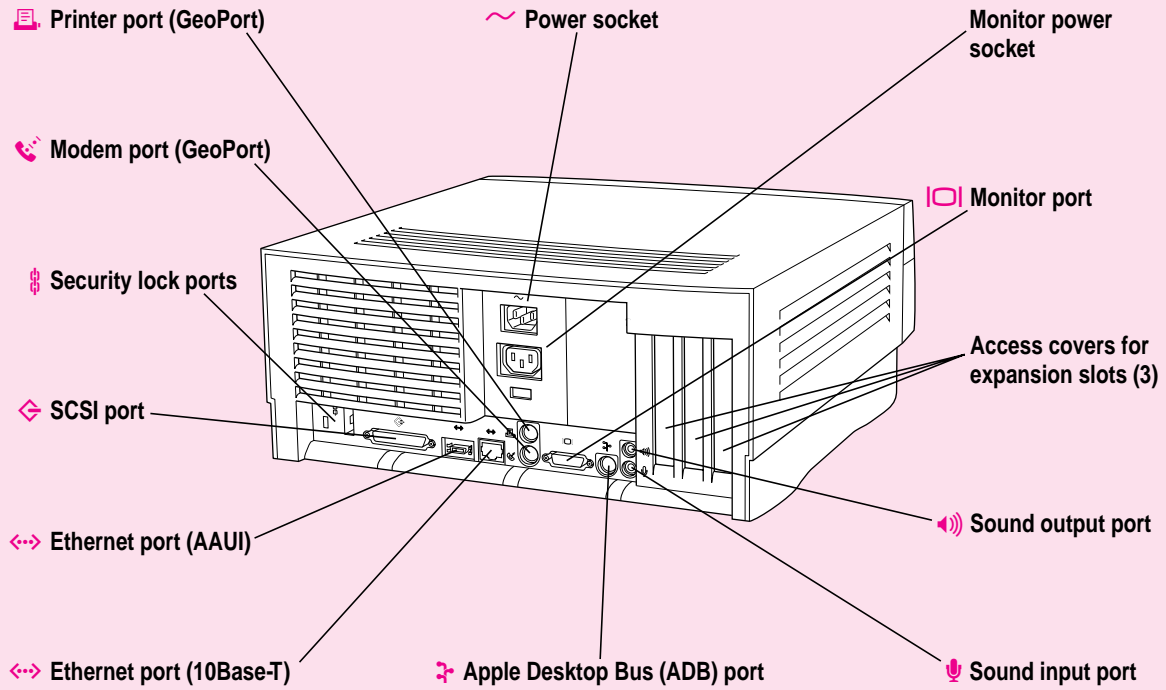

Power key

Use this key to turn your computer on and off.



Your Computer's Ports and Connectors



	Printer port (GeoPort)	Connects your Macintosh to a printer, LocalTalk network or GeoPort Adapter
	Modem port (GeoPort)	Connects an external modem, GeoPort Adapter, or LocalTalk cable to your Macintosh
	Security lock ports	You can attach a security lock to your Macintosh. See your computer products retailer for security lock devices that work with your computer.
	SCSI port	Connects your Macintosh to SCSI equipment such as external hard disk drives and scanners
	Ethernet port (AAUI)	Connects your Macintosh to a high-speed Ethernet network using an adapter
	Ethernet port (10Base-T)	Connects your Macintosh to a high-speed 10Base-T Ethernet network
	Apple Desktop Bus (ADB) port	Connects your Macintosh to an input device, such as a keyboard or a trackball
	Monitor port	Connects your Macintosh to a monitor
	Access covers for expansion slots (3)	Your Macintosh supports up to three peripheral component interconnect (PCI) cards.
	Sound output port	Connects your Macintosh to headphones, externally powered (amplified) speakers, or other audio output equipment
	Sound input port	Connects your Macintosh to an Apple PlainTalk microphone or other audio input equipment

Connecting audio equipment

Your Macintosh can play and record stereo sound from a variety of sources. Your computer has sound input and output ports (also known as “jacks”) like those found on most Macintosh models.

The sound input and output ports

Your Macintosh can handle stereo sound from a sound input device—also called a sound source—such as a microphone, tape deck, or audio CD player. (If you have an internal CD-ROM drive, it can also be used to play audio CDs.) The term “sound input device” is used because the signal goes into your computer for you to record or process in various ways.

Sound input devices can be attached to the sound input port, which is marked with an icon of a microphone (🎤).

Your computer comes with a built-in speaker, but you can attach an additional sound output device, such as amplified speakers or headphones.

Sound output devices can be attached to the sound output port, which is marked with an icon of headphones (🎧) or a speaker (🔊).

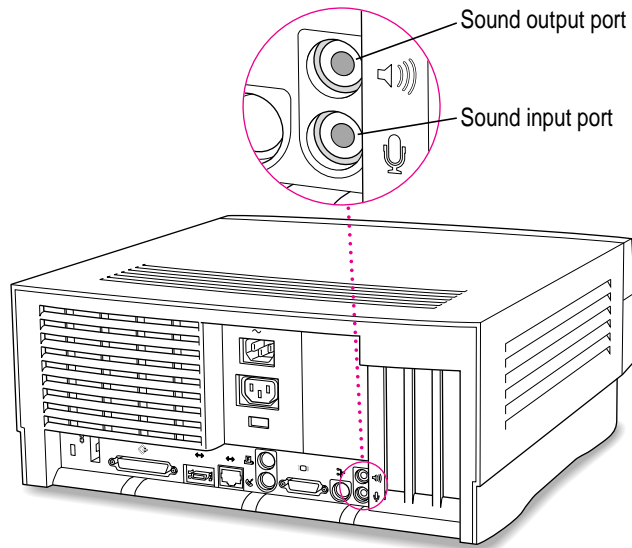

The computer's sound input and output ports accept these 3.5-mm connectors:



Stereo miniplug



Extended miniplug

The “stereo miniplug” is the smaller of the two and is found most often on stereo equipment. The extended miniplug, which is slightly longer and is found on voice quality microphones (such as the Apple PlainTalk Microphone), works only in your computer's sound input port (🎧). (Even though it will fit into the sound output port, it won't work there.) If your equipment has a different type of connector from those shown here, you can purchase an adapter at an electronics supply store.

Connecting most audio equipment

To connect most audio equipment, follow the steps below. For specific instructions on connecting a microphone, skip to the next section, “Connecting and Positioning a Microphone.”

- 1 Make sure that the audio equipment has a cable with a stereo miniplug connector.**

In most cases, the cable will look like one of the following.



Stereo miniplug

Stereo miniplug

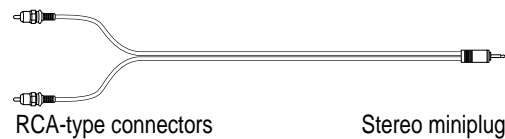

RCA-type connectors

Stereo miniplug

- 2 Place the audio equipment near the computer.**

- 3 Shut down the computer and turn off the audio equipment.
- 4 Attach cables to the audio equipment following the instructions that came with the equipment.

Some equipment (such as most headphones) comes with cables already attached.

- 5 If your audio equipment is a sound input device such as a tape deck, audio CD player, or VCR, attach it to the sound input port (Ⓜ).
- 6 If your audio equipment is a sound output device such as headphones or amplified speakers, attach it to the sound output port (Ⓜ).

The illustration below shows a typical cabling arrangement for amplified speakers that provide a single cable with a single stereo miniplug. (The two speakers are joined to each other by standard speaker wires.) Some speaker pairs have two cables (one per speaker) which must be joined by a dual-plug adapter before they can be attached to the computer's sound output port.

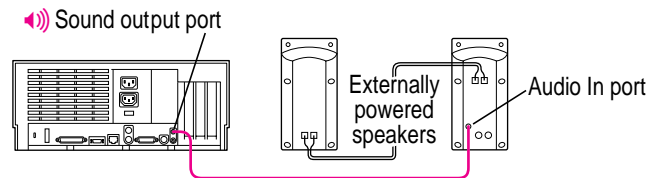

- 7 Turn on the computer and the audio equipment.

You will probably need to adjust the settings (including volume) in the control panel that handles sound on your computer. For instructions, choose Macintosh Guide (or Mac OS Guide) from the Guide (📖) menu; click the Guide's Index button, and choose "sound" from the index.

Connecting and positioning a microphone

You can use the Apple PlainTalk Microphone that comes with some Macintosh computers (or a compatible line-level microphone) to give spoken commands to your Macintosh and to record your voice or other sounds.

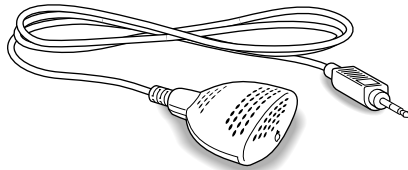

Apple PlainTalk Microphone

Note: Do not use the Apple Omni microphone (the round microphone supplied with some other Macintosh models) or the attenuated RCA adapter provided with some models of Macintosh.

If your monitor has a built-in microphone that you want to use, see the information that came with the monitor to properly connect the microphone.

To connect and position an external microphone, follow these steps:

- 1 Shut down the computer.**
- 2 Plug the microphone's connector into the sound input port (🎧) on the back of the computer.**

- 3 **Place an Apple PlainTalk Microphone at the top center of the monitor, so that the microphone's Apple (🍏) icon is facing you.**

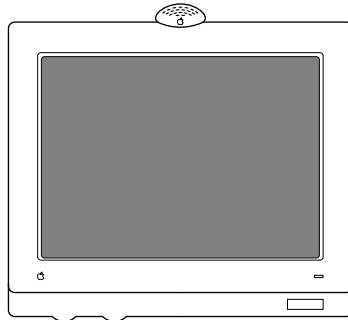

If you're using a different microphone, position it according to these guidelines:

- The microphone should be between 1 and 3 feet away from you.
- The microphone should be directly in front of you to minimize the effect of background noises.

- 4 **Turn on the computer.**

Now that your computer is on, you need to activate the microphone by selecting it as the sound input device.

- 5 **Open the Apple (🍏) menu at the top left corner of your screen, and choose Control Panels.**

- 6 Double-click the Monitors & Sound control panel to open it.

Below is an example of the Monitors & Sound control panel. The control panel may look slightly different on your computer.

- 7 Click the Sound icon at the top of the Monitors & Sound control panel.
- 8 Choose External Microphone from the Sound Input pop-up menu.

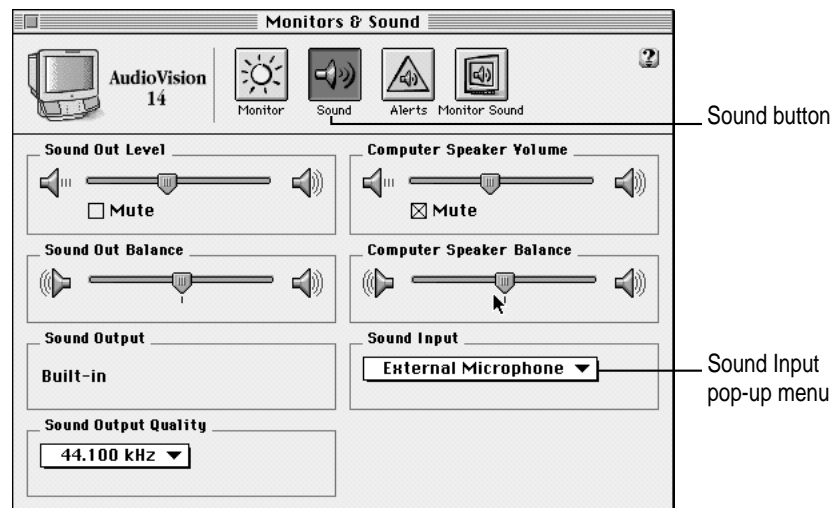

- 9 Click the close box to close the Monitors & Sound control panel window.

Now you're ready to use your microphone.

For more instructions, click the Guide (📖) button in the upper-right corner of the control panel. For information about having the computer read text to you or follow your spoken commands, choose "speech" from the Macintosh Guide index.

Connecting external SCSI devices

Your computer has a port for connecting devices that use the Small Computer System Interface (SCSI, pronounced “skuh-zee”). SCSI is a standard method for connecting disk and cartridge drives, CD-ROM drives, scanners, and other devices. The SCSI port permits high-speed communication between the computer and the device.

The SCSI icon appears above the port on the computer’s back panel.

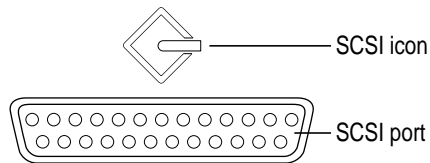

You can connect SCSI devices to the SCSI port in a chainlike fashion. The first device in the chain plugs into the SCSI port; the second device plugs into the first device, and so on.

You can attach up to seven SCSI devices in the chain. Each device on the SCSI chain must have a unique ID number.

Note: In addition to the external SCSI port, your computer has a separate, internal SCSI interface for the internal hard disk and CD-ROM drive. An authorized Apple dealer or service provider can install and attach additional devices to the internal SCSI interface. For more information about the internal SCSI interface, see the *Technical Information* booklet that came with your computer.

Before you connect a SCSI device

Before you connect a SCSI device to your Macintosh, be sure to complete the tasks explained in this section.

IMPORTANT This section contains general instructions for attaching SCSI devices to your computer. Be sure also to follow the specific instructions that came with your external hard disk drive or other SCSI device when connecting the device to your Macintosh. The specific instructions that came with the device tell how to change a device's ID number and attach a SCSI cable or terminator to it.

Make sure each device has a unique ID number

Each external SCSI device connected to your computer must have its own unique ID number from 0 to 6. The SCSI ID number helps the computer keep track of the devices and sort out conflicts when more than one device in the SCSI chain is communicating with the computer simultaneously.

The SCSI devices can be in any physical order in the chain; it is not necessary to arrange them in numerical order.

See the instructions that came with each SCSI device for information on checking and setting its SCSI ID number.

IMPORTANT If you use two or more devices attached to the same SCSI interface with the same ID number, your computer will not start up properly, your equipment could malfunction, and you could lose data as a result.

Make sure you use the right type and length of cable

To attach a SCSI device to your computer or to another device in the chain, always use SCSI cables that are double-shielded, such as Apple SCSI cables. Never use printer-type RS232 cables (commonly used with DOS and Windows computers). Poor quality SCSI cables are often the cause of SCSI problems.

Avoid mixing brands and types of SCSI cables.

If the device is the first or only one you're connecting, use a SCSI system cable to connect it to the computer's SCSI port:

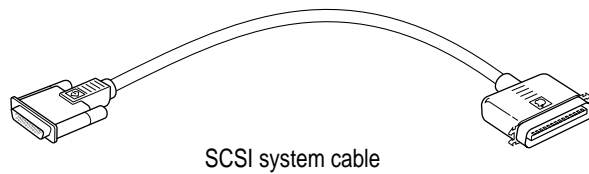

If the device is not the first one, use a SCSI peripheral interface cable to connect it to the last device in the chain:

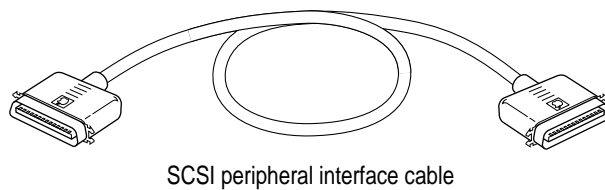

IMPORTANT The total length of the cables in a SCSI chain should not exceed 6 meters (about 20 feet). SCSI cables must have a 110-ohm impedance. For best results, use SCSI cables manufactured by Apple Computer.

Keep the cables between SCSI devices as short as possible. Cables 18 to 24 inches long are best. PowerBooks and some SCSI devices (particularly scanners) may not be able to handle cables longer than 24 inches.

Terminate the SCSI chain properly

To ensure accurate transmission of information, a terminator must be present at each end of a SCSI chain. There is already a built-in terminator at the beginning of the chain. Therefore, you only need to make sure that the last device in the chain has a terminator.

IMPORTANT In almost all cases, only the first and last devices in the SCSI chain should be terminated with the exceptions noted below. Make sure that no external SCSI device but the last one has a terminator.

To terminate the last device in the chain, do one of the following:

- Use a device that has a built-in terminator as the last device in the chain. If you wish to attach two or more SCSI devices that have built-in terminators, an Apple-authorized service provider can remove the extra built-in terminators.
- If the device at the end of the SCSI chain does not have a built-in terminator, attach an external terminator. You can attach or remove external terminators yourself. (Do not use a black terminator; the black terminators are for Macintosh IIfx computers and certain LaserWriter printers only.) Terminators are available at authorized Apple dealers.

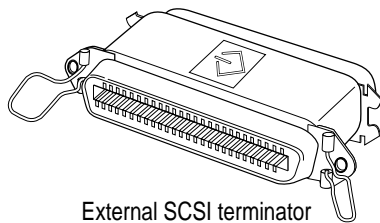

External SCSI terminator

Exceptions to the “first and last” rule: If the SCSI chain is 18 inches or shorter, the terminator on the last device is not needed. If the total cable length in the chain is greater than 10 feet, the chain may need a third terminator at the 10-foot point. Do not add the third terminator unless you are experiencing a SCSI problem, and check all other possible causes of the problem before adding the third terminator.

Connecting a SCSI device

After you read “Before You Connect a SCSI Device” earlier in this chapter, follow the instructions below. Use these general instructions in conjunction with the more specific instructions that came with your SCSI device.

- 1 **Shut down your Macintosh.**
- 2 **Make sure the SCSI device is switched off.**

WARNING Do not connect or disconnect any device while the device or your Macintosh is turned on. Doing so could damage the device, your computer, or both. Do not attach or remove a terminator while the computer or any device is turned on.

- 3 **Use a SCSI cable to connect the device either to the computer’s SCSI port or to the last SCSI device already in the chain.**

Use the thumbscrews and metal clips on the connectors to maintain a tight, reliable connection. Do not overtighten the thumbscrews.

- 4 **Turn on all devices in your SCSI chain.**

IMPORTANT Always turn on all external SCSI devices connected to your Macintosh before turning on the computer itself. Otherwise, your computer won’t be able to recognize that the SCSI devices are connected to it and your computer may not be able to start up.

- 5 **Install any necessary device drivers (software that makes a device work with your computer).**

Drivers needed for a SCSI device usually come on a floppy disk with the device. (If no drivers come with the device, contact the device’s manufacturer.)

Note: If you experience problems after connecting a SCSI device, see the troubleshooting information in Chapter 10, “Solutions to Common Problems” for possible solutions.

Connecting a printer

Your computer has a printer port, which you use to connect a printer.

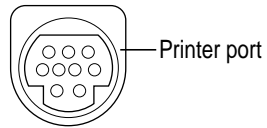

The printer port accepts either a direct cable connection (to printers such as the StyleWriter 2500) or a network cable connection (to printers such as most LaserWriter models). A printer can also be connected to the modem port.

See the manual that came with your printer for more detailed information and instructions on setting up and using the printer. Although your computer comes with most Apple printer software (called “printer drivers”) already installed, you may need to install software from disks that came with your computer.

You use the Chooser to tell the computer which port you used to connect your printer. For instructions on choosing a printer, open the Guide (📖) menu and choose Macintosh Guide (or Mac OS Guide), click the Guide’s Index button, and choose “printing” from the index.

Connecting a second monitor

You can install an expansion card that provides a second monitor port, if one monitor doesn't provide enough screen space.

To connect a second monitor, purchase a video card and install it in one of the computer's PCI expansion slots, or have an Apple dealer install it for you. (If you are installing the expansion card yourself, follow the instructions that came with the card and the instructions in Chapter 8, "Installing PCI Expansion Cards and Additional Memory.") Then plug the second monitor into the port provided by the card.

When you connect an additional monitor, make sure that the ventilation openings on the computer and the monitors are clear and unobstructed.

If there is interference on your screens or on a television or radio near your computer, separate or reposition the affected equipment. You may need to increase the distance between two monitors so that they don't interfere with each other.

IMPORTANT Though it is possible to install additional video cards that supply more monitor ports, do not connect more than two monitors at a time to your computer.

For additional instructions on using two monitors together, choose Macintosh Guide (or Mac OS Guide) from the Guide (📖) menu after you have connected two monitors to your computer; click the Guide's Index button, and choose "monitors" from the index.

Connecting an ADB input device

Your computer has an Apple Desktop Bus (ADB) port, which connects the mouse and the keyboard to your computer. You can add other input devices, such as a bar-code reader, graphics tablet, or joystick.

The ADB port is marked with the  icon.

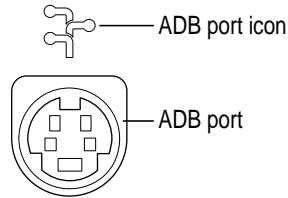

You can connect up to three ADB devices in a chainlike fashion to a single ADB port. The exact number depends on how much power the devices require.

Before you attach or remove an ADB device, turn off the computer. Attaching or removing an ADB device while the computer is turned on could damage the ADB device or your computer.

IMPORTANT The total power used by all ADB devices connected to your computer must not exceed 500 milliamperes (mA). Before attaching another ADB device, check the *Technical Information* booklet that came with your computer and the information that came with the ADB device for power requirements.

Securing your computer

To deter theft of your computer, you can purchase a locking cable and attach it to the security lock port on the computer's back panel. Follow the instructions supplied with the locking cable to secure it to your computer.

To deter theft of the components inside your computer (such as memory, expansion cards, and disk drives), you can install the security bar on your computer, which makes it more difficult to remove your computer's cover.

To install the security bar, do the following:

- 1 Shut down your computer.**
- 2 Position the computer so that the front panel is near the edge of a table.**

In order to install the security bar, you need to be able to see under the front panel. If necessary, unplug the cables from the computer.

- 3 Place the security bar under the front panel so that the hook fits into the slot under the panel. Then tilt the security bar so that the hook slides into the slot.**

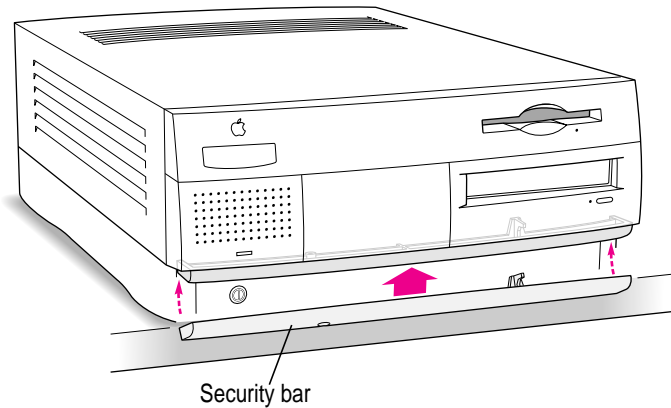

- 4 **Insert the screw into the hole on the security bar and tighten it into place.**

IMPORTANT Do not overtighten the screw.

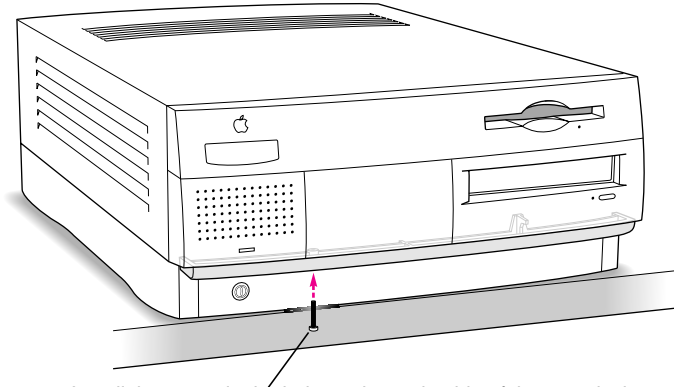

Install the screw in the hole on the underside of the security bar.

Note: For added protection, you can purchase a screw with a less-common head—such as a torque screw—and use it instead of the Phillips screw provided. Use a screw with the following specifications: length: 20 mm; diameter: 3.5 mm; thread pitch: 0.6 mm.

To remove the security bar, remove the screw and press the center of the bar.

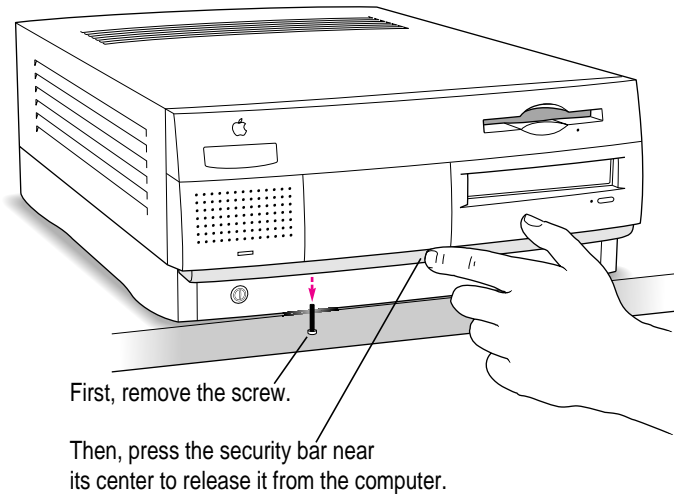

First, remove the screw.

Then, press the security bar near its center to release it from the computer.

Read this chapter for instructions on installing PCI expansion cards and memory in your computer.

8

Installing PCI Expansion Cards and Additional Memory



This chapter provides information about peripheral component interconnect (PCI) expansion cards and memory, and explains how to install both.

Installing a PCI expansion card or memory involves three procedures (detailed steps for each are provided later in this chapter):

- opening the computer
- inserting the card or memory module into a specific slot
- closing the computer

Note: Your computer's PowerPC processor can also be upgraded with the installation of a processor upgrade card. Contact your Apple dealer for information about processor upgrade cards. To install a processor upgrade card, refer to the documentation that comes with the card.

WARNING Although instructions for installing memory and PCI expansion cards are provided in this manual, Apple Computer recommends that you have an Apple-certified technician install them. Consult the service and support information that came with your computer for instructions on how to contact an Apple-authorized service provider or Apple for service. If you install these items yourself, you risk damaging your equipment, and this damage is not covered by the limited warranty on your computer. See an Apple-authorized dealer or service provider for additional information about this or any other warranty question.

About PCI expansion cards

You can install printed circuit boards (called “cards”) for video and graphics applications, networking and communications, additional processing power, or other purposes. The cards fit into connectors, called “expansion slots,” inside the computer.

Your Macintosh has three expansion slots, each designed to accept a 7-inch or 12-inch long PCI card. Install only expansion cards that come with Macintosh drivers and are compliant with the PCI 2.0 standard. NuBus™ cards cannot be used in these expansion slots.

Expansion card power requirements

The combined power consumption of expansion cards must not exceed the limits specified for your Macintosh model. If you have more than one expansion card installed, check the information that came with your cards to make sure that their power consumption is within the limits specified in the *Technical Information* booklet.

WARNING To avoid damaging your computer and expansion card, do not attempt to install any expansion card without first checking the documentation for that card. If the documentation specifies that an Apple-certified technician must install the card (usually because the installation requires special training or tools), consult the service and support information that came with your computer for instructions on how to contact an Apple-authorized service provider for assistance. If you attempt to install the card yourself, any damage you may cause to the computer or card will not be covered by the limited warranty on your computer. If the card is not an Apple-labeled product, check with an Apple-authorized dealer or service provider to see if you can install it yourself.

About memory

You can add memory—dynamic random-access memory (DRAM) or video random-access memory (VRAM)—to your computer in packages called Dual Inline Memory Modules, or DIMMs. You can also upgrade your computer's cache by installing a DIMM.

The following illustration shows the locations of memory slots on the logic board. See the sections that follow for important information about DRAM, VRAM, and cache configurations.

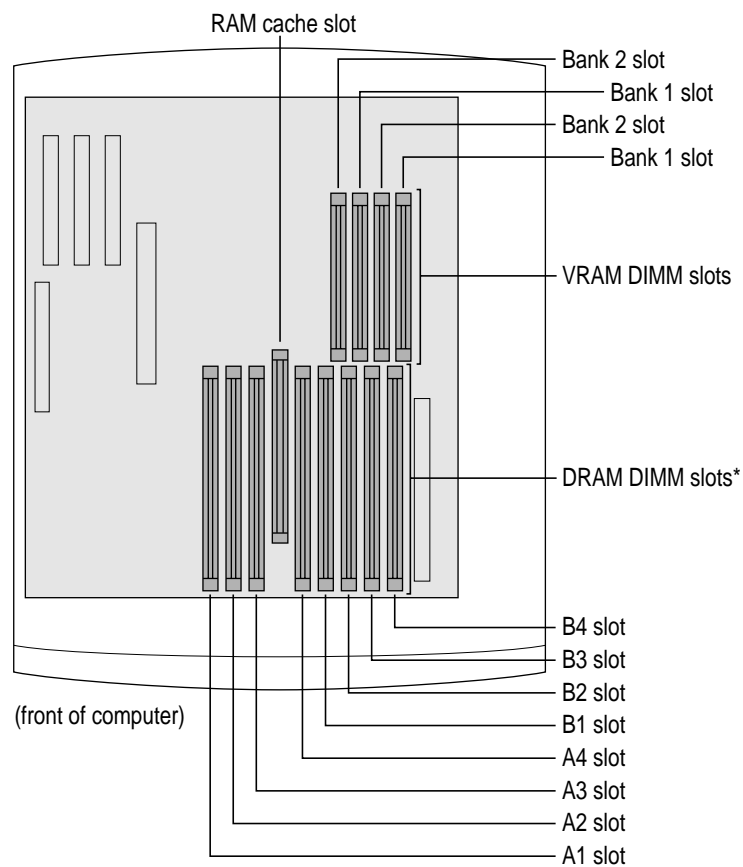

*When installing DRAM, for best performance, fill paired slots. (Slots are paired A1 and B1, then A2 and B2, and so on. It doesn't matter which pairs you use or the order in which you use them.)

DRAM configurations

You can increase your computer's DRAM up to 512 MB. The main logic board has eight DIMM slots which accept DIMMs that meet these specifications:

- 8, 16, 32, or 64 MB (128 MB DIMMs are available, but they have not been tested for use with Power Macintosh computers.)
- 64-bit wide, 168-pin
- 70-nanosecond (ns) RAM access time or faster (If you install DIMMs with different speeds, they will all operate at the speed of the slowest DIMM installed.)
- 1K, 2K, or 4K refresh rate
- extended data output (EDO) or fast-paged mode

IMPORTANT The Single Inline Memory Modules (SIMMs) from older Macintosh computers are not compatible with your computer and should not be used.

DIMMs can be installed one at a time in any order in any of the memory slots. However, if you wish to take advantage of your computer's memory interleaving capability, which provides maximum performance, you must install the DIMMs in pairs, and in paired slots. (Slots are paired A1 and B1, A2 and B2, and so on. It doesn't matter which pairs you use or the order in which you use them, as long as the DIMMs are installed in paired slots.) Memory interleaving allows the computer to read or write to its memory at the same time that other memory reads or writes are occurring, thus providing approximately 5 percent to 15 percent faster performance.

To increase DRAM to the maximum of 512 MB, fill all eight slots with 64 MB DIMMs.

VRAM configurations

Video RAM (VRAM), like standard DRAM, is also provided in DIMMs. Your computer comes with 2 MB of VRAM installed in two 1 MB DIMMs. (These DIMMs are installed in the two bank 1 slots.) Your computer's VRAM can be expanded to a maximum of 4 MB by adding two 1 MB DIMMs to the two bank 2 slots. Both DIMMs must be added at the same time.

IMPORTANT The VRAM DIMMs must be 32-bit wide, 112-pin fast-paged mode with 70-ns RAM access time or faster. Do not use the 256K or 512K VRAM SIMMs used in older Macintosh computers.

Cache configurations

Your computer comes with a cache module already installed. To find out the exact size of the included cache module, see the “Memory” section in your *Technical Information* booklet.

You can replace the existing cache module with a larger one. Cache modules are currently available from third-party manufacturers in various sizes up to 1 MB. However, Apple recommends that you use an Apple-brand cache module if you want to upgrade your existing cache.

Installing a PCI expansion card or memory

Follow these instructions to install a PCI expansion card or memory.

Opening the computer

- 1 If your computer is turned on, turn it off by choosing **Shut Down** from the **Special** menu, then wait 20 minutes.

Before proceeding with these instructions, you need to allow the computer's internal components to cool.

- 2 Make sure the voltage switch is set correctly for the voltage system to which you will be connecting the computer.

If you don't know the voltage used in the country you're in, refer to the table, "Voltages for Different Locations," in the section "Plugging In the Computer" in Chapter 1, "Setting Up Your Computer."

Check to see that the voltage switch on the back of your computer is properly set before you plug it in. If you need to change the setting, insert a small screwdriver in this slot and slide the switch.

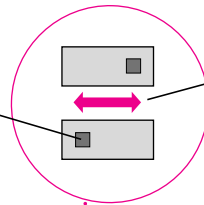

Set the switch to show "115" for voltages in the 100–130 V range.
Set the switch to show "230" for voltages in the 200–270 V range.

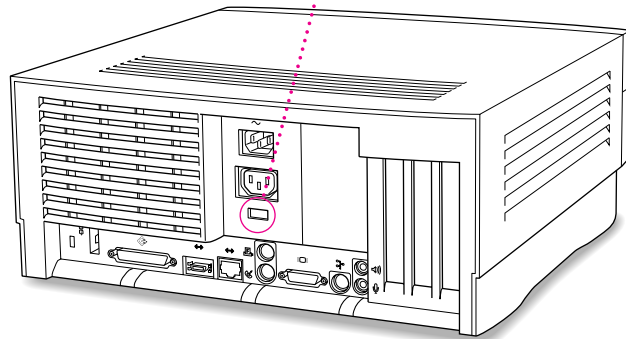

3 Unplug all the cables except the power cord from the computer.

Leave the power cord plugged in, or connect the power cord to your computer and to an AC outlet if you have not already done so. (This helps protect the computer from damage caused by electrostatic discharge.)

4 If the security bar is installed, remove it by removing the screw under the front panel and pressing the center of the bar.

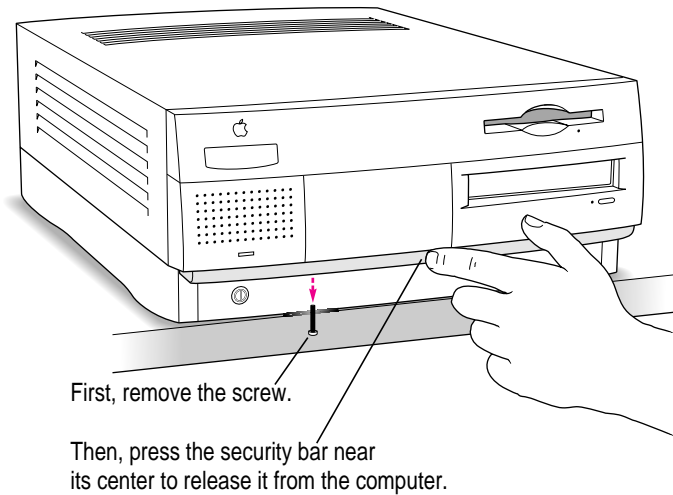

- 5 Press the two release buttons under the front panel and slide the cover toward you approximately two inches.

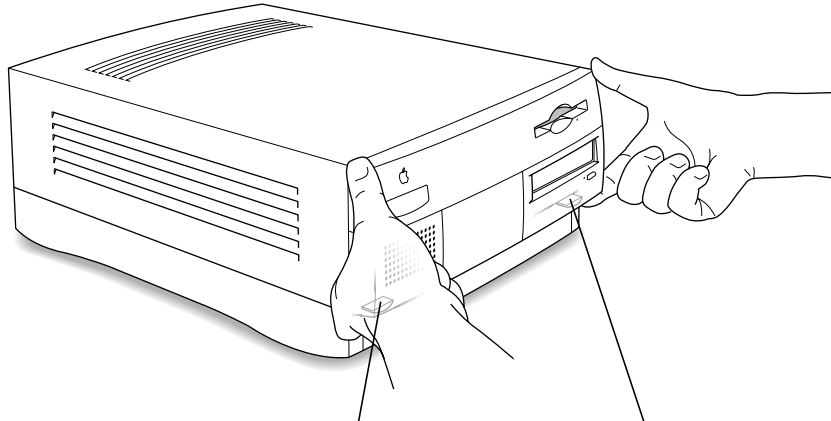

Locate the two release buttons under the front panel ledge with your fingertips.

While pressing the release buttons, pull the top cover forward approximately two inches to release it from the chassis.

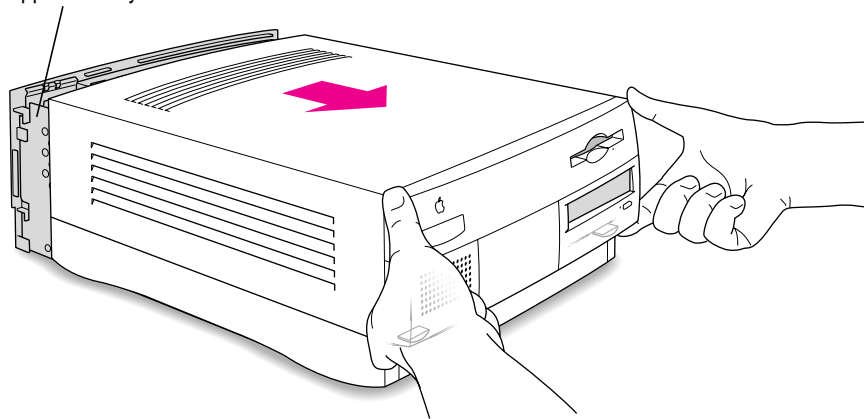

6 Remove the cover from the computer.

After you slide the cover forward about two inches, lift it straight up and off the computer.

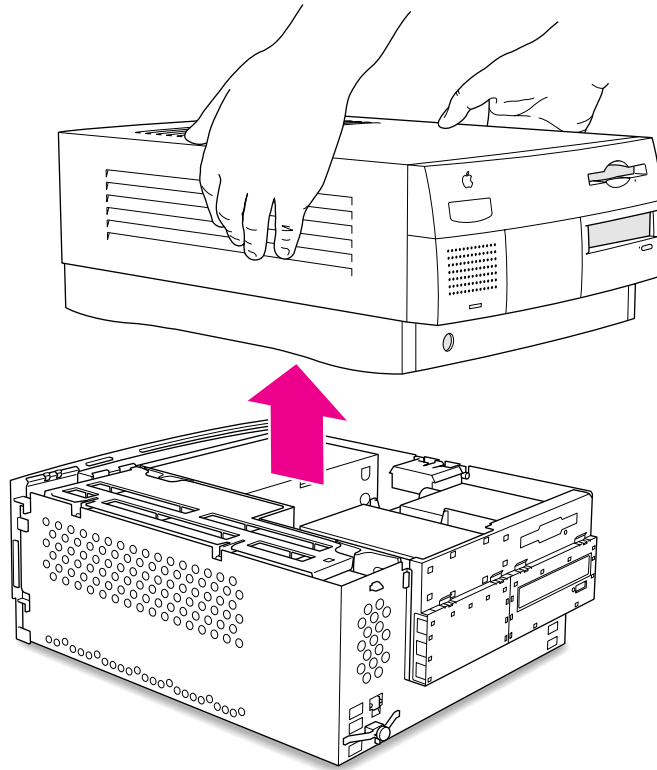

- 7 **Touch the metal part of the power supply case inside the computer to discharge static electricity from your body.**

IMPORTANT Always do this before you touch any parts, or install any components, inside the computer. To avoid generating static electricity, do not walk around the room until you have completed the installation of the expansion card or memory and closed the computer.

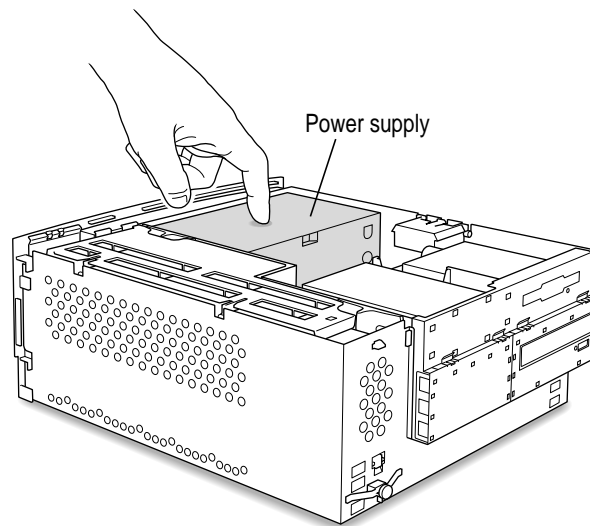

What you do next depends on whether you are installing a PCI expansion card or memory.

- 8 **If you are installing a PCI expansion card, go to the next section, “Installing a PCI Expansion Card.” If you are installing memory, skip ahead to “Installing Memory (DRAM, VRAM, or Cache)” later in this chapter.**

Installing a PCI expansion card

- 1 Flip the expansion card cover open.

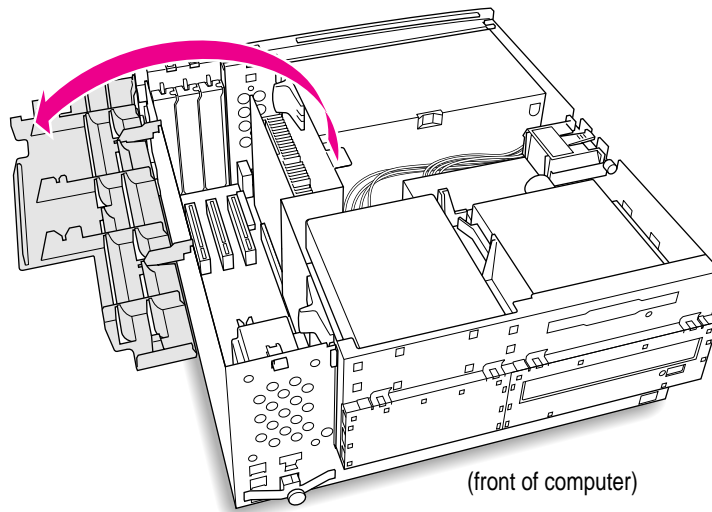

2 Pull out the port access cover and set it aside.

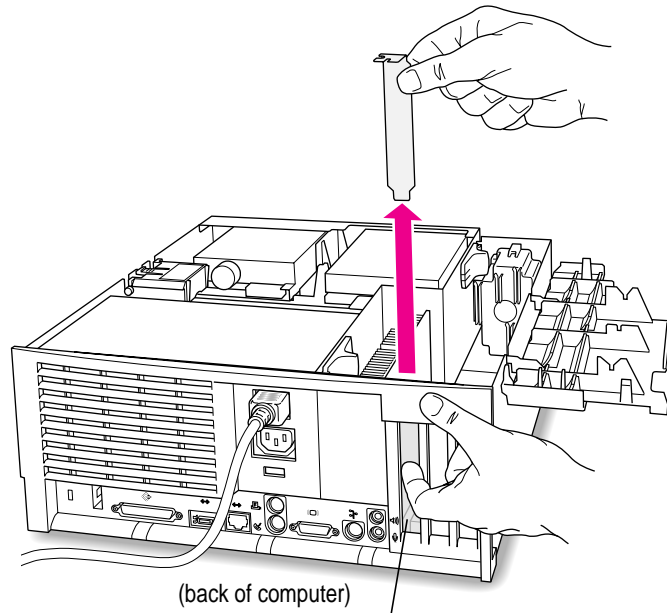

Push the port access cover in gently with the finger of one hand while pulling it straight up with the other hand.

3 Remove the card from its static-proof bag.

Hold the card by its edges to avoid touching the connector or any of the components on the card.

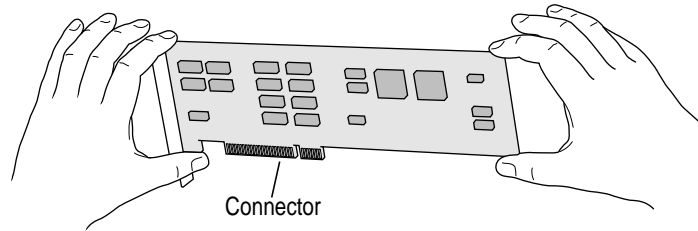

4 Align the connector end of the card with the expansion slot.

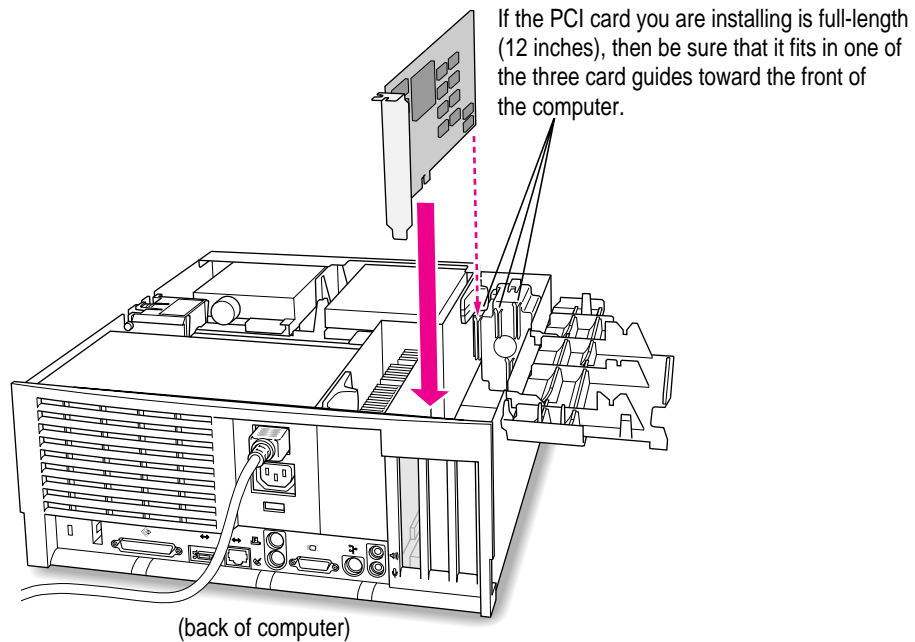
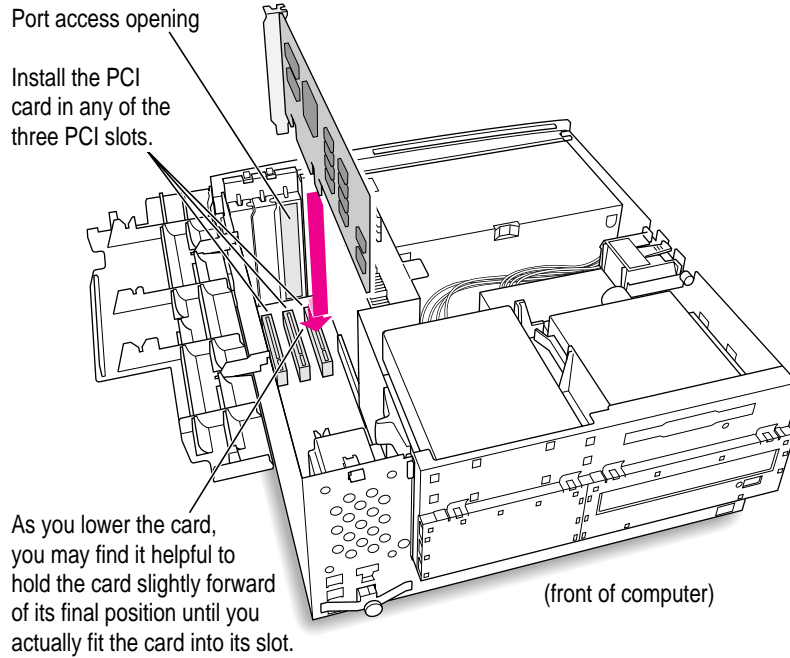

5 Press the card gently but firmly until the connector is fully inserted.

- Don't rock the card side to side; instead, press the card straight into the slot. (Rocking the card can damage the PCI slot.)
- Don't force the card. If you meet a lot of resistance, pull the card out and try again.
- To see if the card is properly connected, pull it gently. If it resists and stays in place, it's connected. (Make sure you don't pull the card so much that you accidentally disconnect it.)

If you have other cards to install, put them in now by repeating steps 2 through 5.

- 6 Flip the expansion card cover up and snap it back into place. (Be sure to snap the cover back down on both ends.)

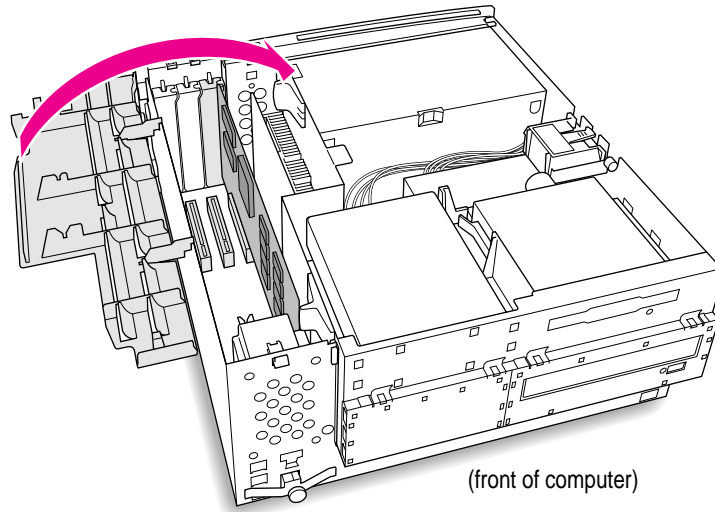

- 7 If you are installing memory, go to the next section, "Installing Memory (DRAM, VRAM, or Cache)." If you are finished installing items in your computer, proceed to "Closing the Computer" later in this chapter.

Installing memory (DRAM, VRAM, or cache)

- 1 Disconnect the power cord from the back of the computer.

Remove the power cord from the back of the computer.

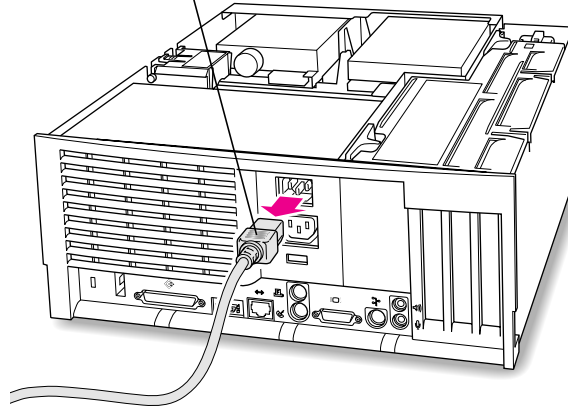

- 2 Flip out the support foot.

Flip the support foot out until it snaps into its locked position.

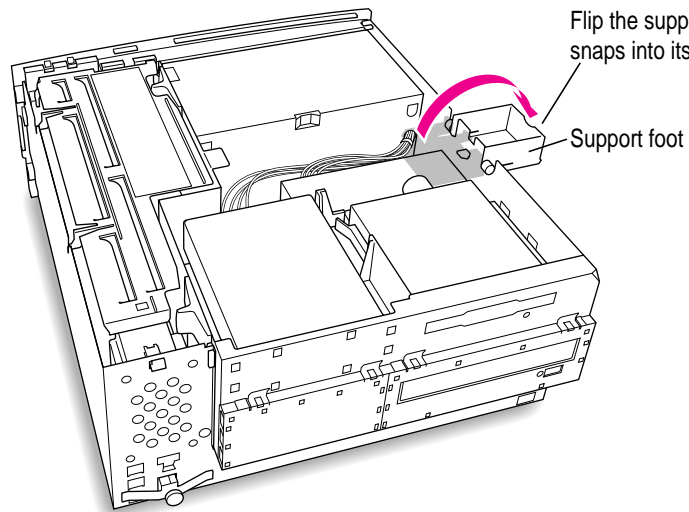

- 3** Unlock the top chassis by pressing the release switches toward the inside of the computer.

Move the release switches toward the inside of the computer to unlock the top chassis.

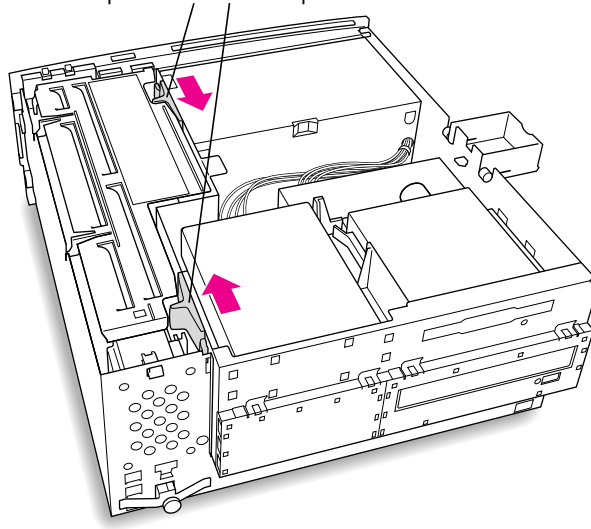

- 4** Using the tab shown below, lift the top chassis up to reveal the memory slots.

You can use this tab to lift the top chassis.

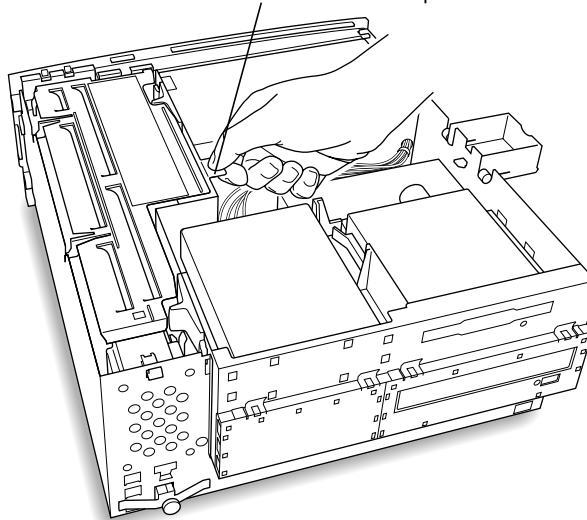

5 Swing the chassis up and insert the support arm in the hole as pictured below.

Gently swing the top part of the chassis up so that it rests on the support foot.

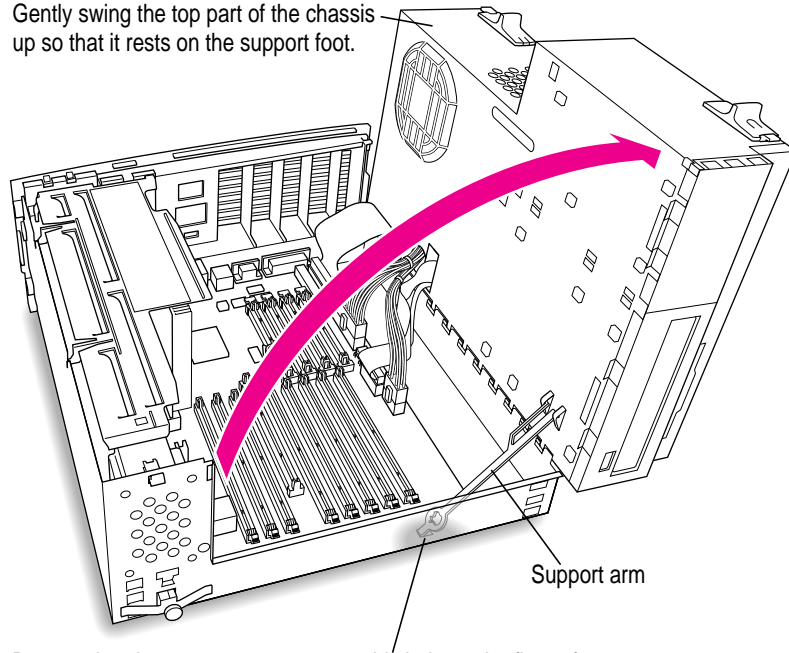

Be sure that the support arm engages this hole on the floor of the bottom chassis so that the top chassis is locked in place.

- 6 If you need to remove one or more existing DRAM DIMMs to make room for new ones, remove them now by following the illustration below.

IMPORTANT Do not touch the DIMM's connectors. Handle the DIMM only by the edges.

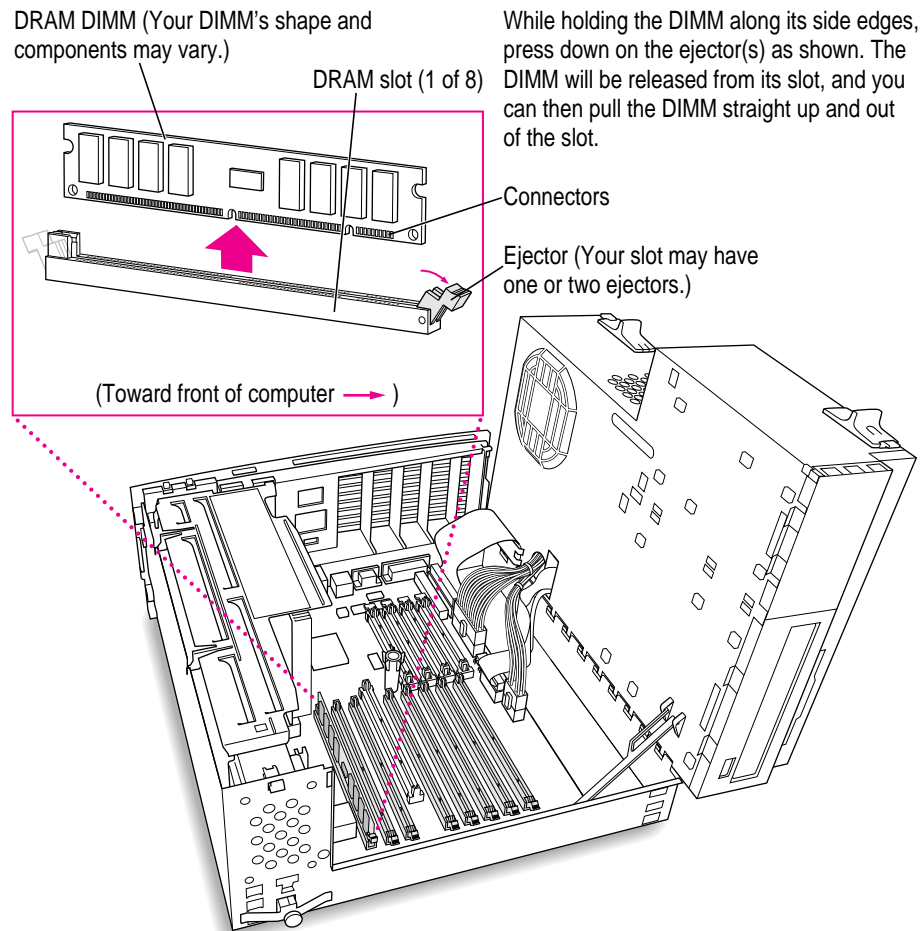

7 If you're installing DRAM DIMMs, align them in the DRAM slots as pictured.

IMPORTANT Do not touch the DIMM's connectors. Handle the DIMM only by the edges.

DRAM DIMM (Your DIMM's shape and components may vary.)

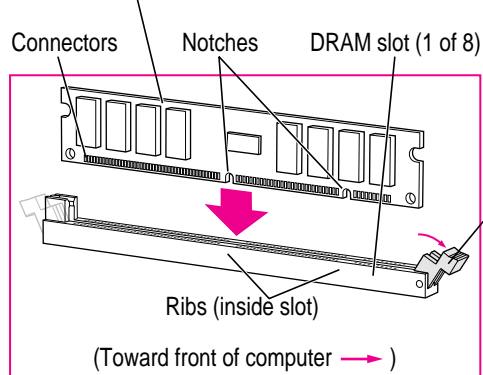

The DRAM DIMM is designed to fit into the slot only one way. Be sure to align the notches in the DIMM with the small ribs inside the slot. With the ejector(s) in the "open" position (as shown), push down on the DIMM until it snaps into place. The ejector(s) will automatically "close."

Ejector (Your slot may have one or two ejectors. They should be pushed outward and down to be in the "open" position, as shown.)

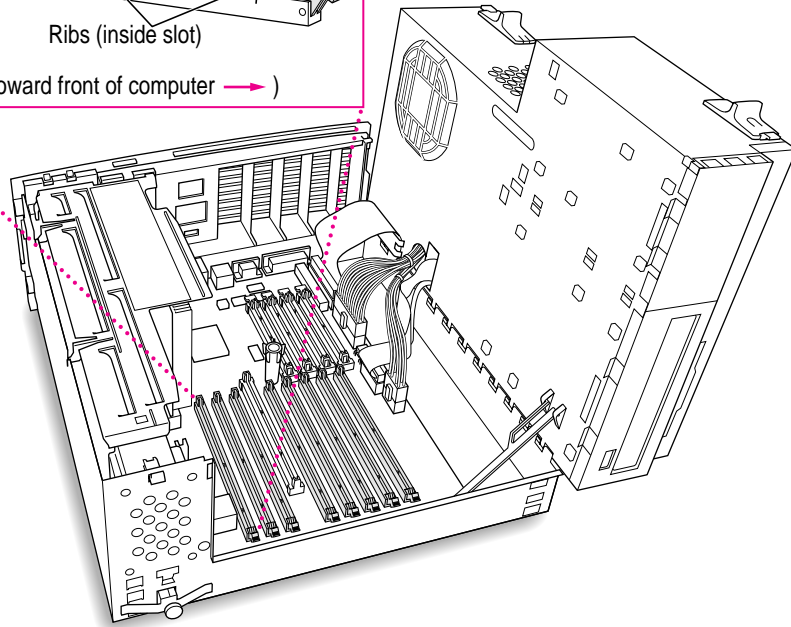

8 If you're installing VRAM DIMMs, place them in the VRAM slots as illustrated below.

IMPORTANT Do not touch the DIMM's connectors. Handle the DIMM only by the edges.

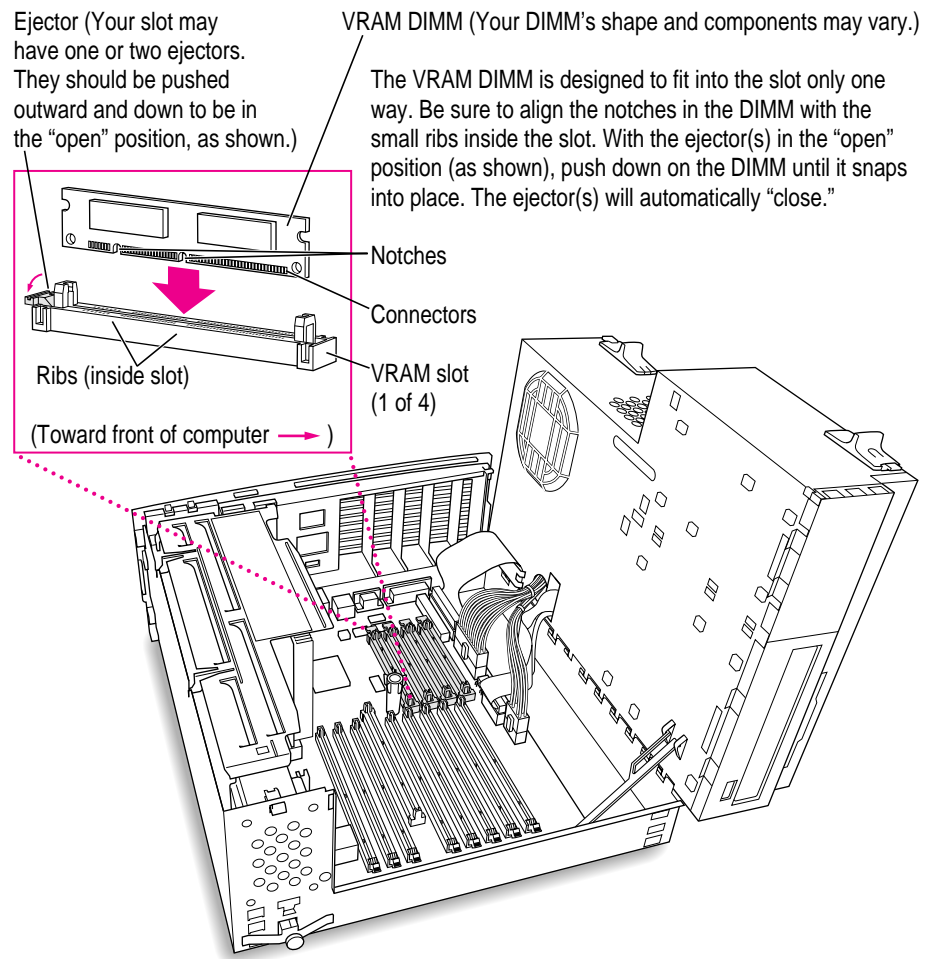

9 If you're upgrading the cache module, remove the old cache module as illustrated below.

IMPORTANT Do not touch the connectors on the cache module. Handle it only by the edges.

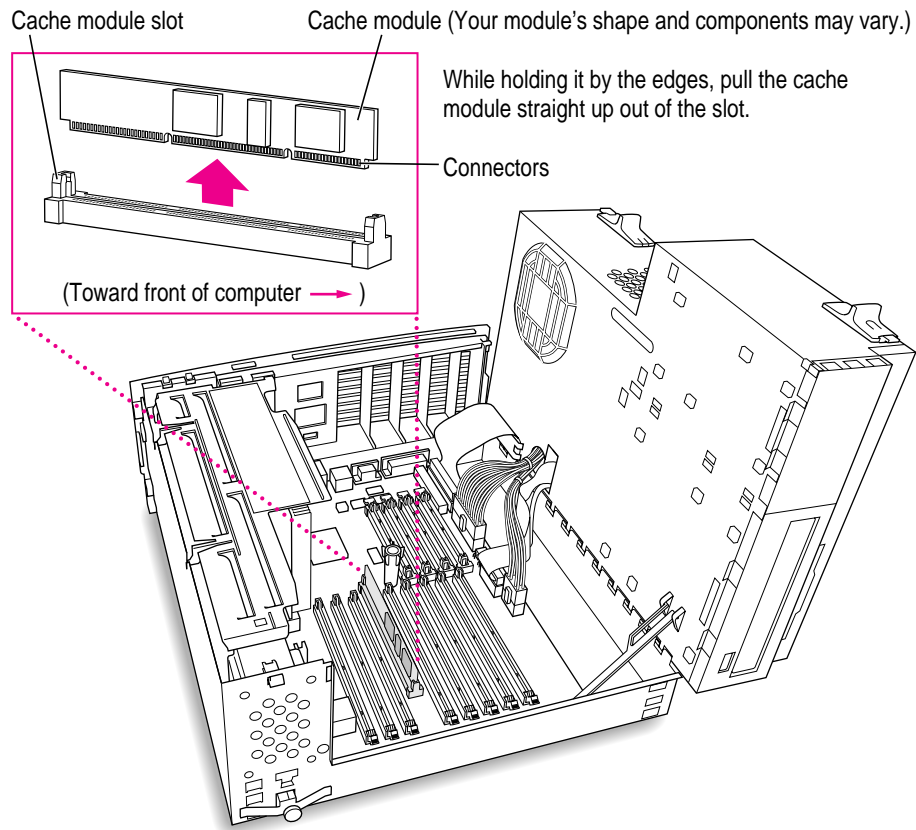

10 If you're upgrading the cache module, insert the new one as illustrated below.

IMPORTANT Do not touch the connectors on the cache module. Handle it only by the edges.

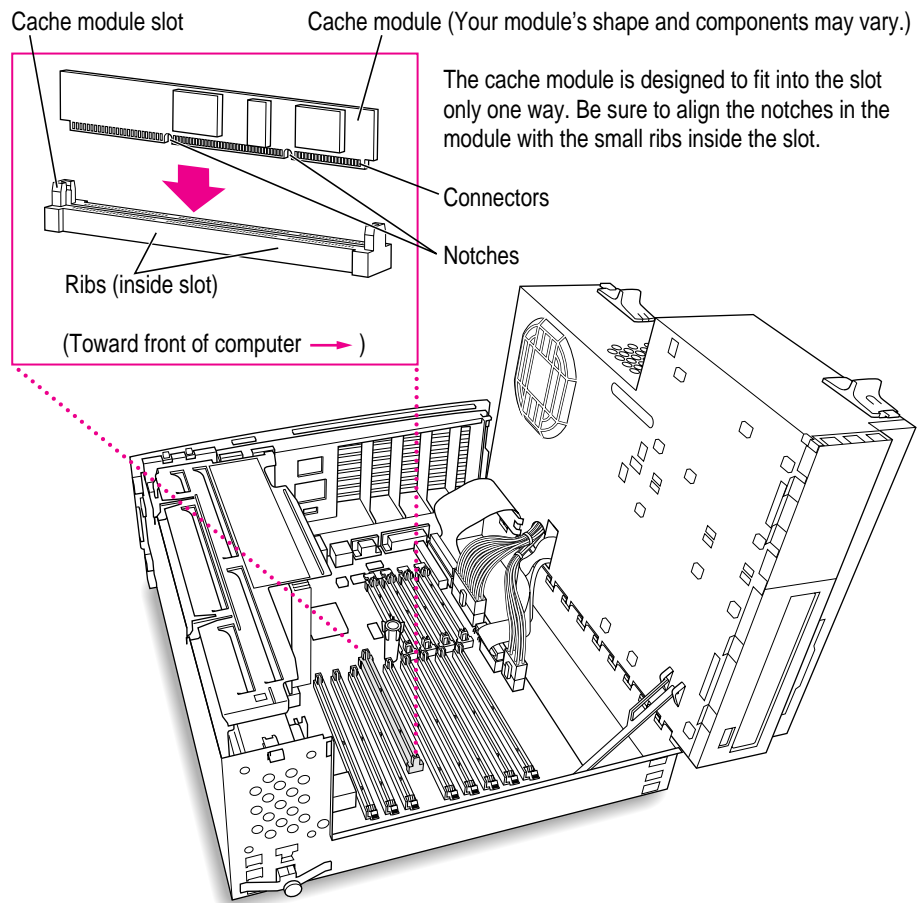

- 11** Replace the chassis by disengaging the support arm and gently swinging the chassis back into place.

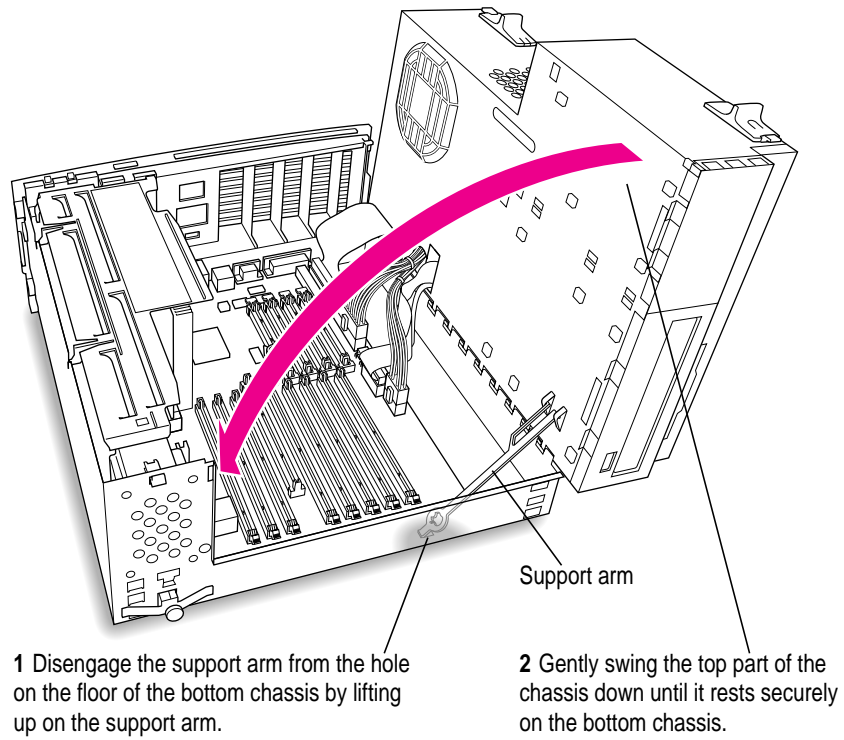

- 12** Lock the chassis back into place by pressing the release switches toward the outside of the computer.

Move the release switches toward the outside of the computer to lock the top chassis.

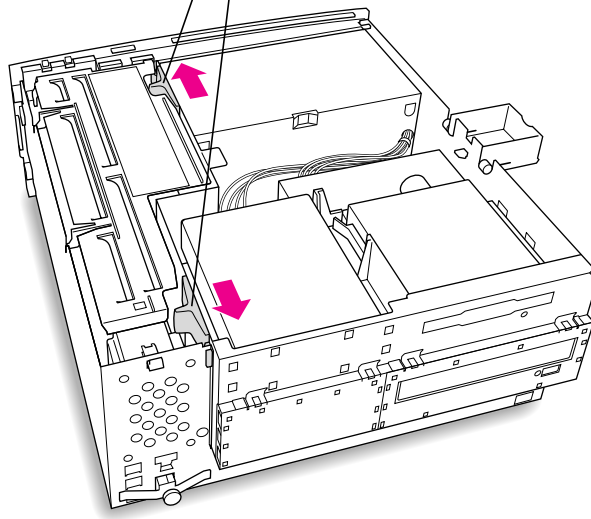

- 13** Unsnap the support foot and swing it back inside the computer housing.

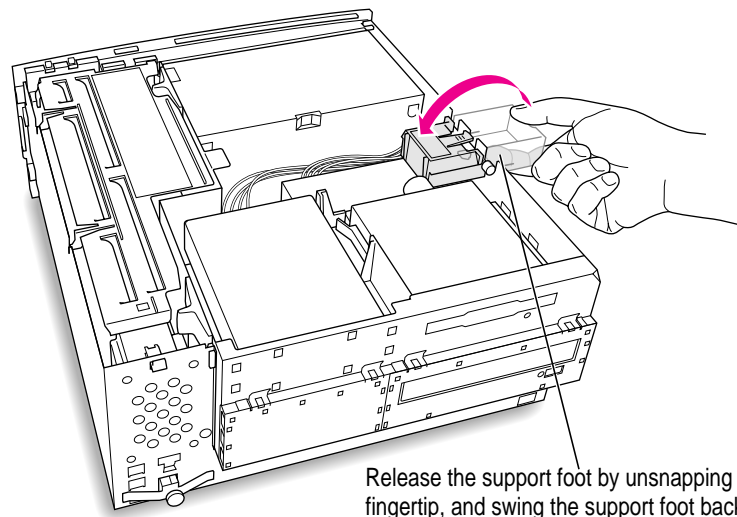

Release the support foot by unsnapping the catch with your fingertip, and swing the support foot back inside the chassis.

- 14** Proceed to “Closing the Computer,” next.

Closing the computer

1 Replace the cover on the computer.

Lower the cover all the way down onto the case, leaving a 2-inch gap. Push the cover back until it snaps into place.

Set the top cover down so that there is about a two-inch gap between the back of the top cover and the back of the chassis.

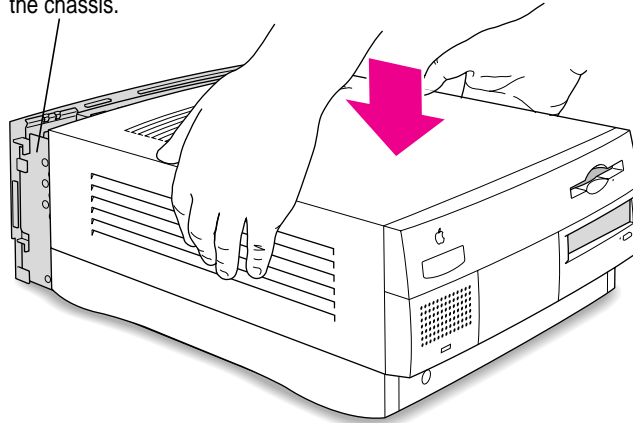

Slide the top cover all the way back until it snaps into place.

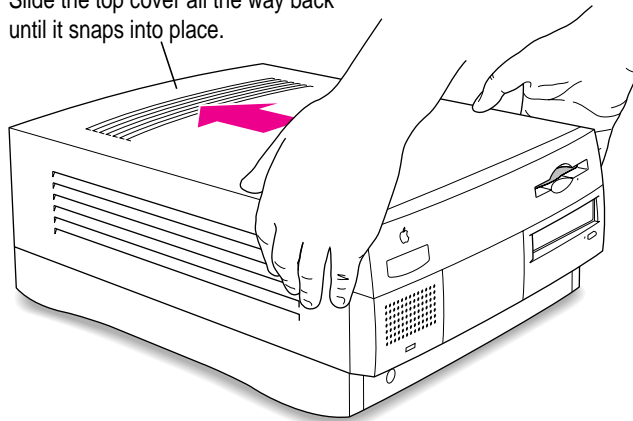

2 Replace the security bar under the front panel if you wish.

Place the security bar under the front panel so that the hook fits into the slot under the panel. Then tilt the security bar so that the hook slides into the slot, reinsert the screw, and tighten it into place.

IMPORTANT Do not overtighten the screw.

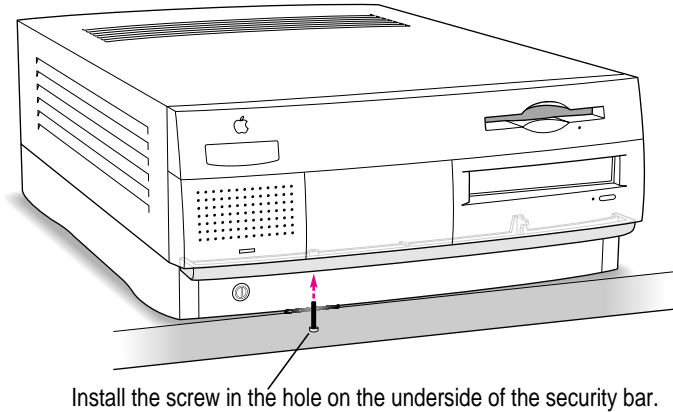
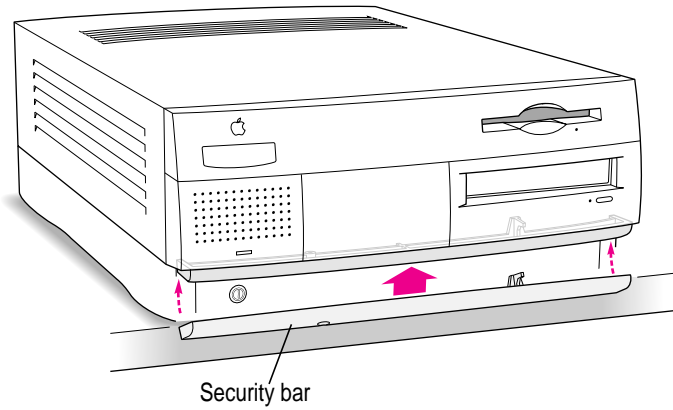

You are now finished with the installation. You may reconnect the cables and power cord you disconnected from your computer, turn on the computer, and start using the equipment you installed.

If you need help reconnecting your cables, see Chapter 1, “Setting Up Your Computer.”

WARNING Never turn on your computer unless all of its internal and external parts are in place. Operating the computer when it is open or missing parts can be dangerous, and can damage your computer.

Troubleshooting

Chapter 9 Start Here If Trouble Occurs

Chapter 10 Solutions to Common Problems

Chapter 11 Diagnostic Techniques



IV
part

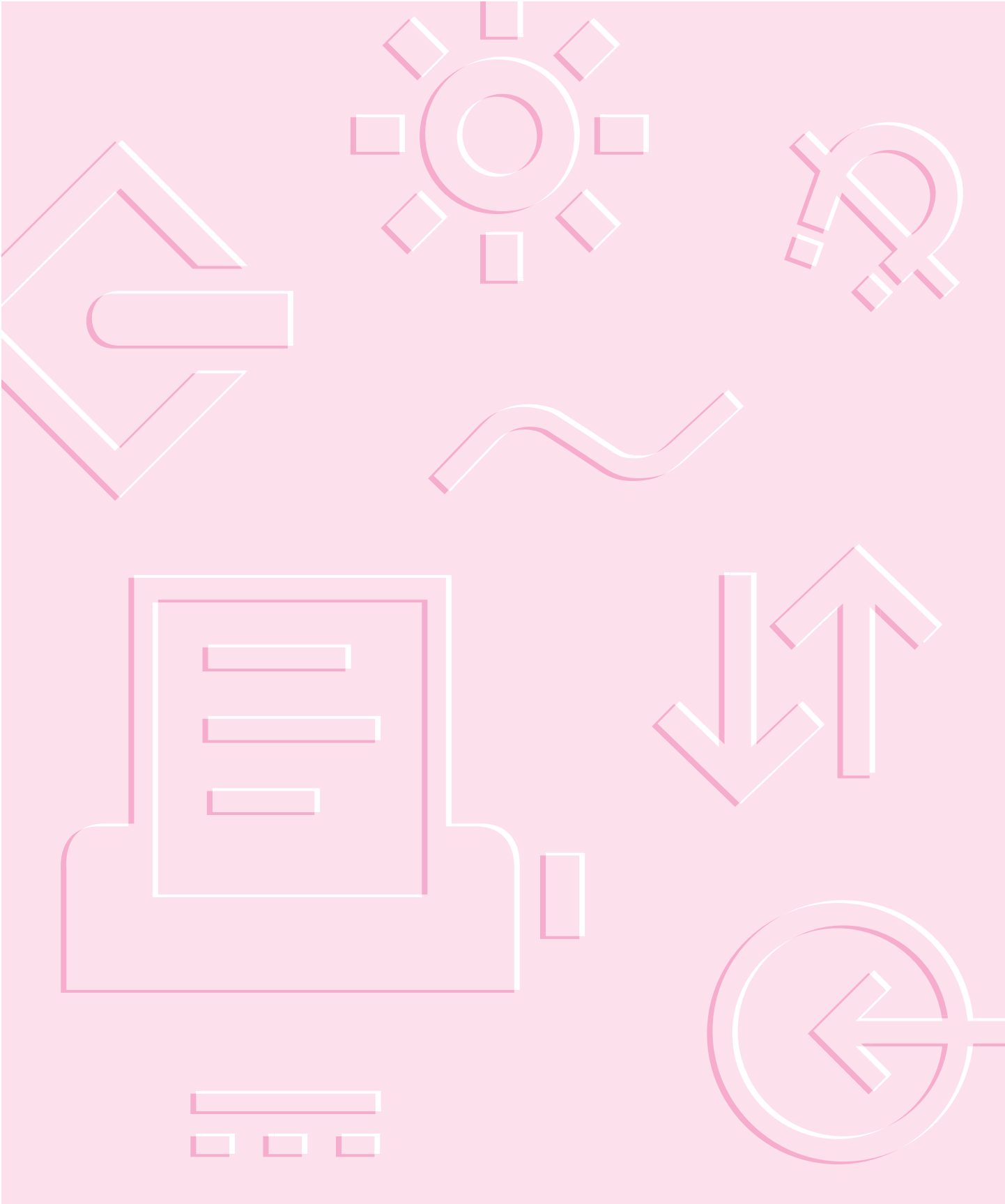

Consult this chapter and Chapter 10 to solve problems with your computer and its system software before you call Apple for assistance.

9

Start Here If Trouble Occurs



Your computer came with a booklet that describes the service and support options that are available from Apple. It contains phone numbers you can call if you have trouble with your computer and also describes many other ways of obtaining support information from online services, the Internet, and automated fax services.

Before you contact Apple for assistance with your computer, however, follow the advice in this chapter and Chapter 10. You'll find you can solve most problems with your computer on your own.

This chapter outlines the best general method for solving problems, and Chapter 10 gives advice about how to solve specific problems.

Step 1: Gather as much information as you can

When you see an error message, you don't have to take action immediately. The message stays on the screen until you click the OK (or Restart) button or turn off the Macintosh.

- Make a note of exactly what you were doing when the problem occurred. Write down the message you see on the screen and its ID number (if any).
- List the programs you were using and the names of any items you know have been added to the System Folder since the system software was installed. This information will help a service person diagnose the problem, if you need to call later.
- Check the screen for any clues. Is a menu selected? What programs and document icons are open? Note anything else that seems relevant.
- If you were typing text and were not able to save it before the problem occurred, write down the parts of the text still visible on the screen so that some of your work will be easy to replace.
- Ask other Macintosh users about the problem you're having; they may have a solution for it.

Step 2: Restart your computer

Often you can eliminate a problem simply by restarting your computer, which clears the computer's memory.

To restart your Macintosh when you are having trouble, try the following steps:

1 If you can, save any open documents before restarting.

If your system is frozen and does not respond to anything you do, or if you have a “bomb” message on the screen, saving may not be possible. You can try pressing ⌘-period to cancel the current operation; if this works, you can then save the open documents before restarting.

2 If you can, choose Restart from the Special menu or from the dialog box that's on screen.

Dialog boxes contain messages from the computer. If something goes wrong, a message may appear on the screen asking you to restart.

3 If you can't choose Restart, press the Power key (marked with a ⏻) on the keyboard.

Click Restart in the dialog box that appears.

4 If the Power key doesn't work, hold down the ⌘ and Control keys while you press the Power key.

This key combination restarts the computer. (Use this key combination only when you can't choose Restart from the Special menu or restart the computer using the Power key.)

5 If your computer still doesn't restart, press the power button on the front of the computer to turn it off, wait at least 10 seconds, and turn it on again by pressing the Power key on the keyboard.

If you suspect that the problem is with other equipment, such as a printer or an external hard disk that's attached to your computer, turn that equipment off for 10 seconds or longer while your computer is off, then turn the equipment on again and restart the Macintosh.

Step 3: Check onscreen help, if you can

Macintosh Guide (or Mac OS Guide on some systems) contains some troubleshooting information that is not included in this user's manual. If you are able to start up your computer properly, choose Macintosh Guide (or Mac OS Guide) from the Guide (📖) menu; click the Guide's Topics button, and choose Troubleshooting from the list.

Step 4: Check the next chapter, "Solutions to Common Problems"

You can probably find a solution for your particular problem in the next chapter, "Solutions to Common Problems."

If you suspect the problem may be with a program not published by Apple, contact the program's publisher.

Step 5: Use Apple System Profiler

Apple System Profiler is a utility that allows you to quickly view different types of information about your computer, helping you and the Apple Assistance Center troubleshoot your computer.

Opening Apple System Profiler

If you are able to start up your computer properly, choose Apple System Profiler from the Apple (🍏) menu to open the utility.

When you open Apple System Profiler, a System Overview window appears.

Getting information about different hardware and software

To get more specific information about different hardware and software used by your computer, or to go back to the System Overview window, choose one of the following commands from the Select menu:

- **System Overview**

This command uses the window to display general information about your computer, including what type of processor it's using, how much memory is installed, and what version of Mac OS is installed.

- **Volume Information**

This command uses the window to display information about disks and disk partitions that your computer can access.

- **Device Information**

This command uses the window to display information about equipment, such as CD-ROM drives and scanners, connected to your computer.

- **Control Panel Information**

This command uses the window to display a list of control panels installed on your computer. Using the buttons in the window, you can choose to view all control panels, only non-Apple control panels, or only Apple control panels. You can also tell whether a control panel is currently enabled.

- **Extension Information**

This command uses the window to display a list of system software extensions installed on your computer. Using the buttons in the window, you can choose to view all extensions, only non-Apple extensions, or only Apple extensions. You can also tell whether an extension is currently enabled.

- **System Folder Information**

This command uses the window to display a list of System Folders on your startup disk. Having more than one System Folder can cause various problems. Therefore, if you see more than one System Folder in the list, the extra one might be responsible for the problem you're having.

Getting help

To find out what the different items in the Apple System Profiler window mean, choose Show Balloons from the Guide (ⓘ) menu. Then point to the item you want to know about.

Consult this chapter for solutions to specific problems with your computer after trying the general troubleshooting tips in Chapter 9.

10

Solutions to Common Problems



This chapter contains descriptions of specific problems you might experience with your computer and solutions for them. If you haven't already tried the general troubleshooting tips in Chapter 9, do that first. Then return to this chapter.

WARNING If you have a problem with your computer and nothing presented in this manual solves it, consult the service and support information that came with your computer for instructions on how to contact an Apple-authorized service provider or Apple for assistance. If you attempt to repair the computer yourself, any damage you may cause will not be covered by the limited warranty. Contact an Apple-authorized dealer or service provider for additional information about this or any other warranty question.

Problems turning on or starting up your computer

The computer is turned on but the screen is dark.

One of the following is probably the cause:

- You have a screen saver program that darkens the screen when the computer has not been used for a certain period of time.
Press a key or move the mouse to turn off the screen saver.
- Your computer has gone to sleep due to inactivity. “Wake it up” by pressing the Power key (marked with a \triangleleft) on the keyboard.
- The monitor’s brightness control (\odot) is not adjusted properly.
Check the monitor’s brightness control and turn it up if necessary.
- The monitor’s contrast control (\bullet) is not adjusted properly.
Check the monitor’s contrast control and adjust it if necessary.
- The monitor is not getting power.
Check that the computer’s power cord is firmly connected and plugged into a grounded electrical outlet, and that the outlet has power. If the computer is plugged into a power strip, make sure the power strip is turned on.
Check that the monitor is plugged in and turned on, and that the monitor cable is firmly connected to both the computer and the monitor.

The computer makes an unusual sound at startup.

- If you hear four tones, try starting up the computer from the system software CD-ROM disc. For instructions, see “Starting Up From the System Software CD-ROM Disc” in Chapter 11, “Diagnostic Techniques.” If the hard disk icon appears after starting up from the system software CD, you can probably repair it using the instructions in “Testing and Repairing Your Hard Disk” in Chapter 11. If the computer does not start up, or if the hard disk icon does not appear, the hard disk may need professional repair. Contact an Apple-authorized service provider or call Apple for assistance.

- There may be a problem with the information stored in the area called parameter RAM (PRAM) or nonvolatile video RAM (NVRAM). Reset the PRAM and NVRAM.

When you reset the PRAM and NVRAM, the settings on most of your computer's control panels revert to their defaults (original, standard settings). You may want to check the settings in your control panels for memory, networking, and monitors, and any aspect of your work that seems affected after you reset the PRAM and NVRAM.

Follow these steps to reset the PRAM and NVRAM:

1. Shut down your computer by pressing the Power key (<⏻>) and then clicking Shut Down.
2. Make sure the Caps Lock key is not engaged.
3. Position the fingers of your left hand on these keys: Command (⌘), Option, and R. Locate the P key, so you can find it quickly for step 4.
4. Press the Power key (<⏻>) to turn on your computer. Immediately after you hear the startup sound, press and hold down the Command (⌘), Option, and R keys at the same time you press and hold down the P key.
5. When you hear the startup sound repeat twice, release the keys, then immediately press and hold down the Shift key to start up with your Extensions turned off. Release the Shift key when you see the message "Extensions off" in the Welcome to Macintosh box.

If you don't see the "Extensions off" message, wait until startup is complete, then press and hold down the Shift key while you choose Restart from the Special menu. Continue to hold down the Shift key until the message appears.

6. Open the System Folder, then open the Preferences folder.
7. Drag the Display Preferences icon to the Trash.



Display Preferences

8. Restart your computer *without* holding down the Shift key.
The computer starts up with your Extensions turned on again.
9. If you had selected special settings in any control panels, open those control panels to respecify the settings you want.

When you start up the computer, you see a message about the system software.

- The system software on the startup disk you're using may be incomplete or damaged or may be the wrong version. Make sure you're using the correct disk as a startup disk.
- If you're sure you're using the correct startup disk, you may need to reinstall system software. See "Installing System Software" in Chapter 11.

When you start up, a disk icon with a blinking question mark appears in the middle of the screen and stays there for longer than 15 seconds.



This icon indicates that your Macintosh cannot find the system software it needs to start up. One of the following is probably the cause:

- Your computer may be having a problem recognizing external SCSI (Small Computer System Interface) equipment, such as hard disks and scanners that you may have connected.

Shut down your computer, turn off all external SCSI equipment, and disconnect the first SCSI device in the chain from your computer's SCSI port (marked with the ⌘ icon). Then restart the computer. If the computer starts up after you disconnect your SCSI equipment, refer both to the manuals that came with the equipment and Chapter 7, "Connecting Additional Equipment," which has information on the proper way to connect SCSI equipment and assign SCSI ID numbers.

If you have a printer connected to your computer's SCSI port, make sure your printer is connected properly. Most printers connect to the printer port, not the SCSI port. Check the manuals that came with your printer for information on how to connect it properly.

- System software is not installed on the startup hard disk, the system software is damaged, or the hard disk is not working properly.

Follow the instructions in “Testing and Repairing Your Hard Disk,” in Chapter 11, “Diagnostic Techniques,” to test your startup hard disk and repair any damage. If repairing the disk doesn’t help, reinstall system software on your startup hard disk. For detailed instructions, see “Installing System Software” also in Chapter 11.

A disk icon with an X appears in the middle of the screen and a floppy disk is ejected from the disk drive.



This icon indicates that the floppy disk you tried to start up from is not a startup disk. (When you turn on your computer, it looks first in the floppy disk drive for a disk containing system software. If the disk in the drive does not contain system software, the computer ejects the disk and looks on its internal hard disk for system software.)

Wait a few seconds. The computer should start up from its internal hard disk. Make sure you insert floppy disks only after the computer has begun starting up.

A “sad Macintosh” icon appears and the computer won’t start up.



This icon indicates that your Macintosh cannot start up because of a problem with the system software or the computer hardware.

Eject any floppy disks by turning off the computer and then holding down the mouse button while you turn the computer on again. Try starting up with the system software CD-ROM disc. Do this by inserting the CD-ROM disc into the CD-ROM drive and holding down the C key while you restart the computer. (For detailed steps, see “Starting Up From the System Software CD-ROM Disc” in Chapter 11, “Diagnostic Techniques.”) If the “sad Macintosh” icon appears again, consult the service and support information that came with your computer for information on contacting an Apple-authorized service provider or Apple for assistance.

The computer freezes after the “happy Macintosh” icon appears but before the “Welcome to Macintosh” message appears.

- Some equipment may not be correctly connected to your computer or an individual piece of external equipment may be causing the problem.
Shut down the computer and disconnect external equipment. To determine which piece of equipment is causing the problem, reconnect them one by one and start up your Macintosh each time until the problem reoccurs.
- If the problem still occurs when no external equipment is connected to the computer, the hard disk may be damaged.

Follow the instructions in “Testing and Repairing Your Hard Disk” in Chapter 11, “Diagnostic Techniques.”

The computer freezes as icons are appearing at the bottom of your screen (system extensions are loading).

- Some equipment may not be correctly connected to your computer or an individual piece of external equipment may be causing the problem.

Shut down the computer and disconnect external equipment. To determine which piece of equipment is causing the problem, reconnect them one by one and start up your Macintosh each time until the problem reoccurs.

- Two or more system extensions may be in conflict with each other.

Restart the computer, holding down the Shift key until you see the message “Extensions off” in the Welcome to Macintosh box. If the computer starts up, turn to “Checking Your System Extensions” in Chapter 11, “Diagnostic Techniques.”

- If the computer still freezes, your System Folder may be damaged.

Follow the instructions in “Performing a Clean Installation of System Software” in the “Installing System Software” section in Chapter 11.

The hard disk icon does not appear on the desktop.

If you don't see a hard disk icon on the desktop, try the following:

- Use the Drive Setup program to make the disk available. Drive Setup is on the system software CD-ROM disc. For instructions on using Drive Setup, follow the instructions in “Testing For Damage On Your Hard Disk” in the section “Testing and Repairing Your Hard Disk” in Chapter 11, “Diagnostic Techniques.”
- If the hard disk is internal, shut down your computer, wait at least 10 seconds, and then turn it on again.
- If the hard disk is external, make sure that it is turned on and that its cable is connected firmly; then restart the Macintosh.
- Check the ID numbers of all SCSI equipment (anything connected to the SCSI port [⌘]) connected to your computer. Each SCSI device must have its own unique ID number. See the manuals that came with your SCSI equipment, in conjunction with Chapter 7, “Connecting Additional Equipment,” for information on setting SCSI ID numbers.
- If the hard disk is your startup disk, follow the instructions in “Testing and Repairing Your Hard Disk,” in Chapter 11, “Diagnostic Techniques,” to test your startup hard disk and repair any damage. If repairing the disk doesn't help, reinstall system software on your startup hard disk. For detailed instructions, see “Installing System Software,” which is also in Chapter 11.

Your computer starts up and you see large folder-shaped areas containing labeled pictorial buttons, instead of the usual Macintosh desktop.

- Your computer may have started up from a CD-ROM disc containing At Ease, an alternative to the Macintosh desktop. You need to have the Macintosh desktop on your screen before you can use any of the instructions in this manual.

To return to the Macintosh desktop, choose Shut Down from the Special menu. After your computer has shut down, restart it and then immediately press the Open/Close button of your CD-ROM drive to open the tray. Remove the CD-ROM disc and gently close the tray. Your computer finishes starting up.

Note: To avoid having the computer start up from a CD-ROM disc, remember to remove any disc in the drive before you shut down your computer.



Your computer won't restart, and there may or may not be a CD-ROM disc in the CD-ROM drive.

- Your computer may be trying to start up from a CD-ROM disc. Press the Open/Close button of your CD-ROM drive to open the tray, and remove the CD-ROM disc. Close the tray, then restart your computer.
- If the computer freezes, you can try to “force” the program you're using to quit by simultaneously pressing the keys Command (⌘), Option, and Esc on your keyboard. Then click Force Quit in the dialog box that appears. (*Note:* Unsaved changes in your current documents will be lost.) Immediately save all open documents, quit all other open programs, and restart the computer.
- If the problem reoccurs, reset the parameter RAM. (See the entry “The Computer Makes an Unusual Sound at Startup,” earlier in this section.)

Every time the computer starts up, it rebuilds the desktop.

- There may be a folder on your hard disk that has the same name as a file the computer uses to keep track of information on your disks. Manually search for a folder named “Desktop” or “Desktop file.” If you find one, rename it. Then restart the computer. (Do not use the Find File feature to search for the desktop file. Find File may find the desktop file but you may not be able to access it.)

When the computer starts up, no icons appear in the windows, and the pointer alternates between an arrow and a wristwatch, or an empty flashing box appears.

- There is a problem with the display of windows. Restart the computer, holding down the Option key until the desktop icons appear. (When the desktop appears, all windows will be closed.)

Problems with application programs, documents, and memory

You can't start an application program; you see a message that not enough memory is available.

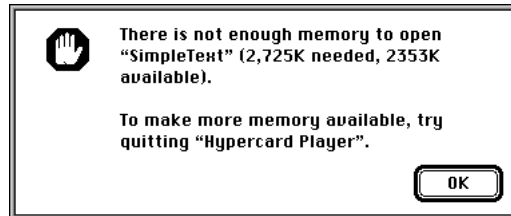

All the memory in your Macintosh is in use by other application programs, system software, and system resources.

- Quit other open programs to free up memory, then open the program you want to use.
- Follow these steps to allocate more memory to the program:
 1. Choose About This Macintosh from the Apple () menu. Take note of the number in the Largest Unused Block section. This number tells you how much memory is available to open programs.
 2. Quit the program if it's open, select its icon, and choose Get Info from the File menu. Take note of the numbers in the Minimum Size and Preferred Size boxes.
 3. If the number in the Minimum Size box is larger than the largest unused block, not enough memory is available to use this program. To free memory, quit open programs or restart the computer. You can also type a smaller number in the Minimum Size box if you want to open the program using less memory. But some programs don't work well if you assign them less memory.
 4. If the number in the Preferred Size box is smaller than the largest unused block, you may need to assign more memory to the program. (A program may need more memory if you are working with complex documents.) Type a larger number in the Preferred Size box.

- Use the Memory control panel to reduce the size of the disk cache, remove or reduce the size of your RAM disk, or turn on virtual memory. For more information, see Macintosh Guide (or Mac OS Guide), available in the Guide (🔍) menu.

Note: If you have both virtual memory and a RAM disk turned on in the Memory control panel, don't set both of them at or near their maximum values. Doing so can result in unpredictable or reduced performance by your computer. (RAM disk uses random-access memory, or RAM, as if it were a hard disk.)

- Disable system extensions that you don't need. For more information, see the topic on system extensions in Macintosh Guide (or Mac OS Guide), available in the Guide (🔍) menu.
- If you have installed system software additions from the Apple Extras folder such as Apple VideoPhone or PlainTalk, you may want to remove them if you are not using them. (This software can decrease the amount of memory available for use by application programs.) To remove a system software addition, locate and run the Installer for the software, and use its "Custom Remove" option to remove it.
- If you frequently want to open more programs than memory allows, you may want to install more random-access memory (RAM). See Chapter 8, "Installing PCI Expansion Cards and Additional Memory."

The computer “freezes.”

- Your computer may be trying to complete a task, but it’s taking so long that it seems that the screen has frozen. If you need to do something else instead, try simultaneously pressing the Command (⌘) key and the period key (.) to cancel the task the computer is working on.
- There may be a temporary software problem that can be fixed by restarting your computer. Follow the instructions in “Step 2: Restart Your Computer” in Chapter 9, “Start Here If Trouble Occurs.”

If the problem reoccurs, it may involve one or more of your application programs. See the next entry for additional suggestions.

A dialog box with a bomb appears, or a dialog box indicates that a software application program has quit unexpectedly.

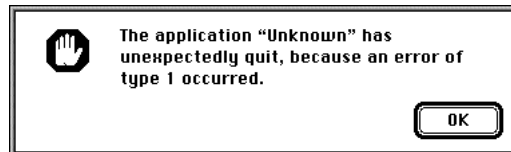
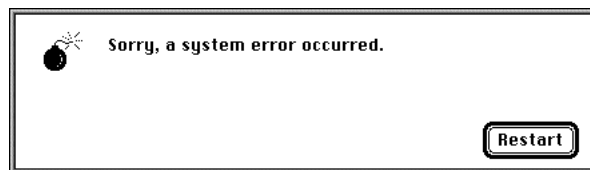

The application program needs more memory, or there is a software problem.

- Write down what you were doing when the message appeared, and write down the text of the message. This information may help a technical support representative diagnose your problem if you later need to contact Apple or the manufacturer of the application program.

About the codes in error messages: The number codes in error messages are used in software development. Sometimes they can help a technician narrow down the source of a problem. However, the codes are usually too general or technical in nature to help you diagnose a problem yourself.

- Restart your Macintosh. (For detailed steps, see Chapter 9, “Start Here If Trouble Occurs.”) Most software problems are temporary, and restarting the computer usually corrects the problem.
- Check for multiple System Folders on your startup disk, using the Find File command. Throw away extra System Folders. The System Folder that your computer is using has a small computer icon on it, which distinguishes it from any other System Folder.



System Folder

- Check for viruses on all your disks, using a virus-detection program. Eliminate any viruses the program finds.
- Use the program’s Info window to give it more memory. (Select the program’s icon and choose Get Info from the File menu.) For more information on increasing a program’s memory, see the memory topic in Macintosh Guide (or Mac OS Guide), available in the Guide (⌘) menu.
- If the problem occurs when you are trying to print, there may not be enough memory for printing. Quit other open programs to free up memory.
- If the bomb only occurs in one application program, check for multiple copies of the program on your hard disk. Use the Get Info command to check the programs’ version numbers. Keep one copy of the latest version and throw away all other copies.

Also, try reinstalling the program from the original disks. If reinstalling doesn’t solve the problem, contact the manufacturer of the program to see if the program contains software errors or “bugs” and if it is compatible with the version of system software you’re using.

- Sometimes incompatible system extensions or control panels can cause system software problems. Restart while holding down the Shift key; this temporarily turns off all system extensions.

If your computer works normally after you do this, use the Extensions Manager control panel (in the Control Panels folder in the Apple [🍏] menu) to turn on extensions and control panels one at a time. Restart after you turn on each extension and control panel. This procedure should identify incompatible extensions and control panels. (If you just added new software to your computer, its system extension is the most probable cause of the problem.) For detailed instructions, see the information about managing system extensions in Macintosh Guide (or Mac OS Guide), available in the Guide (🔍) menu.

If your computer performs better when a particular extension or control panel is turned off, contact the software's manufacturer for information or an upgrade.

A program won't open.

- The application program may already be open. Check the Applications menu to see which programs are running.
- There may not be enough memory available to open the program. Quit any programs you're not using and try again. If that doesn't work, try restarting the computer.
- If the program is on a floppy disk, make sure the disk is unlocked. (You unlock a disk by sliding the tab at the corner of the disk so that it covers the hole.)
- The program may be damaged, or it may not be compatible with PowerPC technology. Check to make sure the software is PowerPC-compatible, and install it from a known good source (such as the original program disks).
- Check that the program is compatible with the version of system software that you are using. (See the program's documentation, or contact the manufacturer or vendor.)

You can't open a document, or you see a message that an application program can't be found.

The document may have been created with a program that is not on your hard disk, or with a different version of the program.

- Try starting a program that you think might be able to open the document. Then choose Open from the program's File menu to open the document. For more information, see the documentation that came with the program.
- Purchase and install the correct software to use the document, or find out if the creator of the document can convert it to a form that one of your programs can use.
- Rebuild your desktop. For instructions, see "Rebuilding Your Desktop" in Chapter 11, "Diagnostic Techniques."
- Don't try to open the files in your System Folder. Most of the files in your System Folder are used by your computer for internal purposes and are not intended to be opened.
- If the document is from a DOS or Windows computer, read the next section.

You experience problems using a document from a DOS or Windows computer.

If you can't open a DOS or Windows document by double-clicking its icon, try one of the following:

- Open the document from within the program by choosing Open in the program's File menu.
- Use the PC Exchange control panel (in the Control Panels folder in the Apple [🍏] menu) to specify which Macintosh program will open the document.

If a DOS document is displayed incorrectly, or you see strange codes or characters in the document, try one of the following:

- Your application program may have special procedures for opening and saving documents with different file formats. See the information that came with your program, or call the program's publisher.
- Try opening the document in another program.

Note: Some characters that can be displayed on the Macintosh are not accurately displayed on DOS computers.

For information about working with DOS or Windows documents on your Macintosh, see Macintosh Guide (or Mac OS Guide), available in the Guide (🔍) menu.

A file can't be thrown away.

- The file may be locked. Select the file's icon, choose Get Info from the File menu, and click the Locked checkbox to remove the X. You can delete locked files that are in the Trash by holding down the Option key while you choose Empty Trash from the Special menu.
- An application program may be using the file. Close the file or quit the program.
- If the file is on a floppy disk, the disk may be locked. Unlock the disk by sliding the tab so that it covers the hole at the corner of the disk.
- The file may be in a shared folder that can't be changed. You can throw away the file by turning off file sharing temporarily (click Stop in the Sharing Setup control panel). Or you can select the shared folder, choose Sharing from the File menu, and uncheck the box labeled either "Can't be moved, renamed, or deleted" or "Same as enclosing folder."

You see a message that your application program can't be opened because a file can't be found.

Macintosh programs designed specifically for the PowerPC microprocessor (also called “native” applications) use special files called “shared libraries.” Any necessary shared libraries should be installed automatically when you install these special Macintosh programs.

Follow the directions that came with your program to reinstall it. If the shared library is still missing, contact the software program's manufacturer for assistance.

You experience problems using an older Macintosh program.

Some older Macintosh programs are not completely compatible with Macintosh computers that have the PowerPC microprocessor.

- Open the Memory control panel (in the Control Panels folder in the Apple [🍏] menu) and turn off Modern Memory Manager.
- If that doesn't work, contact the program's publisher to see if an upgrade is available.

A window has disappeared.

- Another open window may be covering the one you're looking for. Move, resize, close, or hide windows until you see the one you want.
- The program the window is associated with may be hidden. Choose Show All from the Application menu and then click the window you want, or choose the program from the Application menu.

Problems with CD-ROM drives and discs

Problems using the CD-ROM drive

The CD-ROM drive icon does not appear on the screen.

- If you reinstalled the CD-ROM software, make sure to restart your computer afterward.
- Make sure that the Apple CD-ROM extension is turned on in the Extensions Manager control panel. (Open the Extensions Manager control panel in the Control Panels folder in the Apple [🍏] menu). Then restart your computer.

The computer keeps asking you to reinsert a CD-ROM disc after you've ejected it.

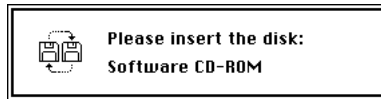

- An application program or document from the CD-ROM disc is still open and is “looking for” the disc. Reinsert the CD-ROM disc and close the documents or quit the application programs that are open on the disc. (Go to the Application menu in the upper-right corner of your screen and make sure that the Finder is the only application listed. If not, select one of the other applications programs and then choose Quit from the File menu. Do this for any other applications listed in the Application menu.) Then eject the CD-ROM disc by selecting its icon and choosing Put Away from the File menu or by dragging the CD-ROM disc’s icon to the Trash.
- You may not have properly ejected the CD-ROM disc. To eject the disc properly, reinsert it, select the CD-ROM disc icon, and choose Put Away from the File menu. (You can also drag the CD-ROM disc’s icon to the trash.) If you eject a CD-ROM disc by choosing Eject Disk from the Special menu, the computer remembers the CD-ROM disc in its memory and keeps asking you to reinsert it.

The tray of your CD-ROM drive won't open.

If a CD-ROM disc icon appears on your screen:

- Drag the disc icon to the Trash, or select it and choose Put Away from the File menu. (*Note:* You won't lose information on the CD-ROM disc by dragging its icon to the Trash. *Don't* select the disc icon and then choose Eject Disk from the Special menu.)

If the AppleCD Audio Player is active, choose Eject CD from the File menu or click the eject button in the AppleCD Audio Player controller.

If no CD-ROM disc icon appears on your screen:

- Restart your computer. Immediately after you hear the startup chime, press the Open/Close button of your CD-ROM drive.
- The signal to open the tray may not be reaching the computer. To manually open the tray, turn off your computer, locate the small pinhole to the lower right of the CD-ROM tray opening, and insert the end of a large straightened paper clip about 1.25 inches into the pinhole. Push gently but firmly until the tray is released, then carefully pull the tray open. (Do not force the tray open; wait until the paper clip has dislodged it to be sure you don't break the front of the tray.) Remove the CD, turn on your computer, and press the Open/Close button of your CD-ROM drive to see if it is working properly.

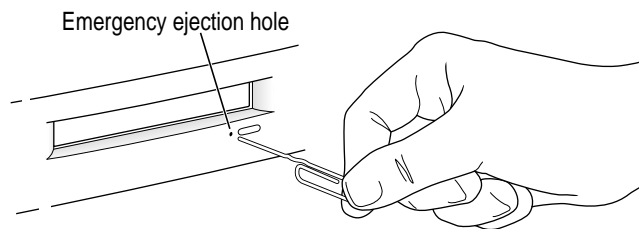

WARNING Turn off your computer before you attempt to eject the tray using a paper clip. If you don't, you may damage the CD-ROM drive.

If neither of these suggestions works, your CD-ROM drive may be damaged. Contact an Apple-authorized service provider or Apple for further assistance.

Your computer won't restart, and there may be a CD-ROM disc in the CD-ROM drive.

- Your computer may be trying to start up from a CD-ROM disc. Press the Open/Close button of your CD-ROM drive to open the tray, and remove the CD-ROM disc. Close the tray, then restart your computer.

Your CD-ROM disc is vibrating in the CD-ROM drive.

- Some CD-ROM disc labels have artwork that is noticeably thicker on one side than the other and can cause the disc's weight to be slightly off-center. This uneven distribution of weight coupled with the high rotation speed of your CD-ROM drive can cause some discs to wobble in the drive and make your computer vibrate. The vibration damages neither the CD-ROM disc nor the computer and affects very few CD-ROM discs. If you can feel or hear that the CD-ROM disc is vibrating in the computer, you don't need to do anything special; continue to use the CD-ROM disc as you normally would.

Note: If you use a CD-ROM disc with a removable (sticky) label, remove the label before inserting the disc.

Your computer starts up and you see large folder-shaped areas, containing labeled pictorial buttons, instead of the usual Macintosh desktop.

- Your computer may have started up from a CD-ROM disc containing At Ease, an alternative to the Macintosh desktop.

To return to the Macintosh desktop, choose Shut Down from the Special menu. After your computer has shut down, restart it and then immediately press the Open/Close button of your CD-ROM drive to open the tray. Remove the CD-ROM disc and gently close the tray. Your computer finishes starting up.

Note: To avoid having the computer start up from a CD-ROM disc, remember to remove any disc from the drive before you shut down your computer.

Problems using CD-ROM discs

You insert a CD-ROM disc, but its icon doesn't appear on the Macintosh desktop.

- Make sure that the disc label is facing up and the disc is centered in the tray.

IMPORTANT If you're using a small (8 cm) disc, make sure it's centered within the tray's inner ring and the computer is absolutely level. An improperly seated small disc in your computer may result in damage to the disc, the CD-ROM drive, or both.

- Make sure the tray is closed all the way.
- Try restarting your computer.
- Make sure that the Apple CD-ROM extension is turned on in the Extensions Manager control panel. (Open the Extensions Manager control panel in the Control Panels folder in the Apple [🍏] menu). Then restart your computer.
- Try starting your computer from the system software CD-ROM disc that came with your computer; insert the CD and restart while holding down the C key. (For detailed steps, see "Starting Up From the System Software CD-ROM Disc" in Chapter 11, "Diagnostic Techniques.") If only the hard disk icon appears on the desktop, then there may be a hardware problem with your CD-ROM drive. If the CD-ROM disc icon appears above the hard disk icon, reinstall your CD-ROM software. The easiest way to do this is by reinstalling your system software, following the instructions in Chapter 11, "Diagnostic Techniques."

Your computer displays the message "This is not a Macintosh disk: Do you want to initialize it?" when you insert a CD-ROM disc in the CD-ROM drive.

- Make sure that the Foreign File Access extension is installed and turned on. Use the Extensions Manager control panel in the Control Panels folder in the Apple (🍏) menu to turn it on, then restart your computer.
- The disc may use a format that the Macintosh cannot recognize. Ask the disc's manufacturer for a disc that a Macintosh can recognize.

Your computer ejects a CD-ROM disc without giving you any error message.

- Make sure the disc is lying flat in the tray and the disc label is facing up.

IMPORTANT If you're using a small (8 cm) disc, make sure it's centered within the tray's inner ring and the computer is absolutely level. An improperly seated small disc in your computer may result in damage to the disc, the CD-ROM drive, or both.

- The disc may need to be cleaned. (See "Handling CD-ROM Discs" in the section "Handling Your Computer Equipment" in Appendix A.) If there are visible scratches on the shiny side of the disc, you may be able to remove them with a CD-ROM disc polishing kit (available from your audio CD dealer). If the scratches can't be removed, you need to replace the disc.
- The disc may be damaged. Try another disc in the drive, and try the original disc in another drive. If the original drive reads other discs or if the original disc also doesn't work in another drive, the disc is probably damaged. You need to replace it.

You can't open a document on a CD-ROM disc.

- Try starting a program that you think might be able to open the document. Then choose Open from the program's File menu to open the document.
- Read the manual that came with your CD-ROM disc. Some discs come with software that you need to install before using the disc.

You can't save changes you make to information on a CD-ROM disc.

- A CD-ROM disc is a read-only medium. This means that information can be read (retrieved) from it, but not written (stored) on it. You can save the changed information on a hard disk or floppy disk.

Your CD-ROM disc is vibrating in the CD-ROM drive.

- Some CD-ROM disc labels have artwork that is noticeably thicker on one side than the other and can cause the disc's weight to be slightly off-center. This uneven distribution of weight coupled with the high rotation speed of your CD-ROM drive can cause some discs to wobble in the drive and make your computer vibrate. The vibration damages neither the CD-ROM disc nor the computer and affects very few CD-ROM discs. If you can feel or hear that the CD-ROM disc is vibrating in the computer, you don't need to do anything special; continue to use the CD-ROM disc as you normally would.

Note: If you use a CD-ROM disc with a removable (sticky) label, remove the label before inserting the disc.

Problems using ISO 9660 or High Sierra discs

You cannot access files on a CD-ROM disc that uses the ISO 9660 or High Sierra format.

- Discs in the ISO 9660 and High Sierra disc formats have version numbers attached to file names. Some application programs need these version numbers in order to work with files. To make the version numbers available to programs on your computer, follow these instructions.

Drag the CD-ROM disc icon to the Trash. When the tray opens, hold down the Option key and push the tray back in. Continue to hold down the Option key until the disc is mounted in the drive. The program you are using should now be able to locate file names on that CD-ROM disc.

- Make sure that Foreign File Access, ISO 9660 File Access, and High Sierra File Access files are present in the Extensions folder in the System Folder on your hard disk. If these files are not present, reinstall your CD-ROM software. The easiest way to do this is by reinstalling your system software, following the instructions in Chapter 11, "Diagnostic Techniques."

Problems playing audio CDs

You don't hear any sound when you play an audio CD or an audio track on a CD-ROM disc using the AppleCD Audio Player.

- If you have headphones or speakers connected to the computer, make sure they are firmly connected. Make sure the volume control on your headphones or speakers is not turned down too low.
- If you do not have headphones or speakers connected to the computer, make sure that nothing else is plugged into the computer's sound output port (🔊).
- If you are using a CD-ROM disc over a network, you won't be able to hear the audio portion.
- Make sure the volume is turned up in the AppleCD Audio Player. With the program open, drag the volume control slider up, use the volume controls on your computer, or press the Up Arrow key on your keyboard.
- The CD may have been paused. Click the Play/Pause button in the AppleCD Audio Player once or twice.

While playing an audio track on a CD-ROM disc that combines audio tracks and data, you double-click the disc icon and the audio track stops playing.

- You can't open data files on a CD-ROM disc and listen to audio tracks on it at the same time.

You are unable to record sound from an audio CD.

- You may need to reset the sound options in the Monitors & Sound control panel. Refer to the information on sound in Macintosh Guide (or Mac OS Guide), available in the Guide (📖) menu.

Problems using Photo CDs

You insert a Photo CD disc, but its icon doesn't appear on the desktop.

- Reinstall the CD-ROM and QuickTime software. The easiest way to do this is by reinstalling your system software, following the instructions in Chapter 11, "Diagnostic Techniques."

Your computer does not display color icons for individual images on a Photo CD.

- Your computer may be low on memory. To view color icons, restart your computer and then reopen the Photos folder. See Macintosh Guide (or Mac OS Guide), available in the Guide (⌘) menu, for more information on managing memory.

After you open an image file on a Photo CD, the image is scrambled, colors are displayed incorrectly, or no image appears in the window.

- The program you are using may not be designed to work with large (high-resolution) image files. You can open the image with another program or you can assign more memory to the program. See Macintosh Guide (or Mac OS Guide), available in the Guide (⌘) menu, for more information on managing memory.

After you open an image on a Photo CD, your system "freezes" and does not respond to any input, or you have a "bomb" message on your screen.

- Restart your Macintosh. (If you need help restarting your computer, see Chapter 9, "Start Here If Trouble Occurs.") The program you are using may not be designed to work with large (high-resolution) image files. You can open the image with another program or you can assign more memory to the current program. See Macintosh Guide (or Mac OS Guide), available in the Guide (⌘) menu, for more information on managing memory.

Problems with floppy disks and floppy disk drives

You can't eject a floppy disk.

If you can't eject a floppy disk in the usual way, by selecting the disk's icon and choosing Put Away from the File menu or by dragging the disk's icon to the Trash, try the following in order:

- Hold down the ⌘ and Shift keys and press the number 1 key on your keyboard.
- Shut down the computer. If the disk isn't ejected, then hold down the button on your mouse or other pointing device while you start up the computer again.
- Locate the small hole near the disk drive's opening, and carefully insert the end of a large straightened paper clip into it. Push gently until the disk is ejected. Do not use excessive force.

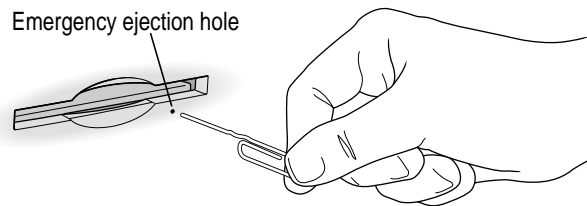

If none of these solutions works, take the computer or disk drive to your Apple-authorized service provider to have the disk removed.

You can't save or copy files onto a floppy disk.

- The disk may be locked. Unlock it by sliding the tab at the corner of the disk so that it covers the hole.
- The disk may be full. Throw away items on the disk that you no longer need, or save the files on a different disk.
- The disk may be damaged. Test it with Disk First Aid, which is located on the system software CD-ROM disc.
- The disk drive may be damaged. To see if this is the problem, try saving or copying files onto another floppy disk. If you are still unsuccessful, the drive may need professional repair. Contact your Apple-authorized service provider or call Apple for assistance.

After inserting a floppy disk, you see the message, "This is not a Macintosh disk: Do you want to initialize it?" or "This disk is damaged: Do you want to initialize it?"

- The floppy disk may be new and not yet initialized. If you're sure the disk has never been used, click Yes.

WARNING Clicking Yes erases all data that may be on the disk. Therefore, only click Yes if you're sure the disk contains no important data. If you're not sure, click No.

- The disk may have been formatted for use on DOS/Windows systems, or some other kind of computer. If so, see the tips that follow.
 - Click No in the dialog box asking you if you want to initialize the disk.
 - Make sure the PC Exchange control panel is in the Control Panels folder (in the Apple [🍏] menu) and that it is turned on. Also, make sure PC Exchange is enabled in the Extensions Manager control panel. For more information about Extensions Manager, see the information about managing extensions in Macintosh Guide (or Mac OS Guide), available in the Guide (📖) menu.

- When formatting floppy disks on a DOS computer for use in a Macintosh, you need to format standard double-sided disks as 720K disks and high-density disks as 1440K disks. Double-sided disks formatted in 1440K format and high-density disks formatted in 720K format may not work in a Macintosh.

If you think your DOS floppy disk might have a format that doesn't work in a Macintosh, use a DOS computer to copy the contents of the disk onto a properly formatted disk.

- The floppy disk may be too warm or too cold to be read. You can warm up a cold disk safely by setting it on top of your monitor for a few minutes. You can cool an overly warm disk by placing it in a shady, cool place.

- The disk drive may be damaged. To see if this is the problem, click No to eject the disk; then insert the disk into another drive, if you have one. If you still see the message, the floppy disk may be damaged. If the disk icon appears on the desktop, one of the drives may be damaged. (When a disk that was written on by one drive cannot be read by another, the heads on one of the drives are out of alignment. The drive that is misaligned or broken may not be the drive that cannot read the disk; try the disk in three or four drives to identify the drive with the problem.)
- If none of these suggestions works, the floppy disk is probably damaged. First use a disk recovery program to copy the data from your damaged disk onto a good disk. For instructions, see the documentation that came with the disk recovery program. Then, use Disk First Aid (located on the system software CD-ROM disc) to repair the damaged floppy disk.

The computer keeps asking you to reinsert a floppy disk after you've ejected it.

- An application program or document from the floppy disk is still open and is “looking for” the disk. Reinsert the disk and close the documents or quit the application programs that are open on the disk. (Go to the Application menu in the upper-right corner of your screen and make sure that the Finder is the only application listed. If not, select one of the other application programs and then choose Quit from the File menu. Do this for any other applications listed in the Application menu.) Then eject the floppy disk by selecting its icon and choosing Put Away from the File menu.
- You may not have properly ejected the floppy disk. To eject the disk properly, reinsert it, select the floppy disk icon, and choose Put Away from the File menu. If you eject a floppy disk by choosing Eject Disk from the Special menu, the computer remembers the floppy disk in its memory and keeps asking you to reinsert it.

Problems with hard disks

The computer won't start up from the internal hard disk, or the hard disk icon doesn't appear on the desktop.

- There may be a temporary software problem. Turn off the computer, wait at least 10 seconds, and then turn it on again.
- There may be a problem with your startup disk or with its system software. See “Testing and Repairing Your Hard Disk” in Chapter 11, “Diagnostic Techniques.”

The computer is using the wrong disk as a startup disk.

- Open the Startup Disk control panel and make sure the correct disk is selected. Then restart the computer.
- If you're trying to start up from an external hard disk, your computer may be having a problem recognizing the disk, which is a SCSI device. Refer to both the manual that came with the hard disk and Chapter 7, “Connecting Additional Equipment,” which has information on the proper way to connect SCSI equipment and assign SCSI ID numbers.
- Reset the PRAM and NVRAM by following the instructions in “The Computer Makes an Unusual Sound at Startup” earlier in this chapter.

Problems with your computer's speed

Your computer's performance decreases

- If you notice a decrease in your computer's speed and general performance after you install a control panel or system extension, it may be because the software is not compatible with either Macintosh computers built with the PowerPC microprocessor or with other system extensions.

To find out if a system extension or control panel is the problem, follow the instructions in the section “Checking Your System Extensions” in Chapter 11, “Diagnostic Techniques.”

- Use the Memory control panel to turn off virtual memory. For more information on virtual memory, see the information about memory in Macintosh Guide (or Mac OS Guide), available in the Guide (🔍) menu.
Note: If you turn on both virtual memory and RAM disk in the Memory control panel, don't set both of them at or near their maximum values. Doing so can result in unpredictable or reduced performance by your computer. (RAM disk uses random-access memory, or RAM, as if it were a hard disk.)
- If you still do not notice an improvement, you may want to reinstall system software on your startup hard disk. See Chapter 11, “Diagnostic Techniques,” for instructions.
- If you typically use several application programs at the same time, your computer's performance will increase if you install more random-access memory (RAM). See Chapter 8, “Installing PCI Expansion Cards and Additional Memory.”

Your computer isn't performing as fast as you'd like.

If, after trying the tips in the previous section, your computer still isn't performing as fast as you'd like, try these suggestions. Each one will make only a small difference in your computer's speed; but if you try them all, you'll notice the improvement.

- Open the Memory control panel in the Control Panels folder in the Apple (🍏) menu; then make these changes:
 - In the Disk Cache section, increase the Cache Size slightly. (Because the amount of memory available for opening programs decreases as you increase the size of the cache, do not set the Cache Size too high.)
 - In the Modern Memory Manager section, click On.
 - In the Virtual Memory section, click Off if you haven't already done so.
- Open the Keyboard control panel in the Control Panels folder; then make these changes:
 - Set the Key Repeat Rate to Fast.
 - Set the Delay Until Repeat to Short.
- Turn off Menu Blinking. Open the General Controls control panel in the Control Panels folder; then click Off in the Menu Blinking section.

- If you don't need to see thousands or millions of colors on the screen, reduce the color depth. Open the Monitors and Sound control panel in the Control Panels folder; then click 256 in the Color Depth section.
- Increase the speed of mouse tracking. Open the Mouse control panel in the Control Panels folder; then set Mouse Tracking to Fast.
- Make sure your computer is not calculating folder sizes. Open the Views control panel in the Control Panels folder; in the List Views section, make sure the checkbox next to Calculate folder sizes is *not* checked.
- If your computer is not connected to an AppleTalk network, turn off AppleTalk. Open the Chooser in the Apple () menu; in the AppleTalk section, click Inactive.

Other problems with your computer

The pointer (↔) doesn't move when you move the mouse.

One of the following situations is probably the cause.

- The mouse or keyboard is not connected properly.

Turn off the computer by pressing the Power key (⏻) and then press return to choose Shut Down. If that doesn't work, press the power button on the front of the computer. With the computer off, check that the mouse and keyboard cables are connected properly. Then restart the computer.

IMPORTANT Do not connect or disconnect the mouse while the computer is turned on. You may damage your computer.

- Signals from the mouse are not reaching the computer, either because the mouse needs cleaning or because there is something wrong with it.

Clean the mouse according to the instructions in Appendix A, "Health, Safety, and Maintenance Tips."

If you have another mouse or pointing device, try connecting and using it. (Turn the computer off before connecting it.) If the new device works, there is probably something wrong with the mouse you replaced. Consult the service and support information that came with your computer for instructions on how to contact an Apple-authorized service provider or Apple for assistance.

- There is a software problem. Try the following:
 - Press ⌘-Option-Esc to quit the application program in use when the problem occurred. If this works, you can save the documents open in other programs before restarting.
 - Restart your Macintosh. For instructions, see Chapter 9, “Start Here If Trouble Occurs.”
- Follow the suggestions in the entry, “A Dialog Box With a Bomb Appears” earlier in this chapter.

Typing on the keyboard produces nothing on the screen.

One of the following is probably the cause:

- You haven't selected any text or set the insertion point (I).
 - Make sure the program you want to type in is the active program. Then place the pointer (⏏) in the active window and click to set an insertion point (I) or drag to select text (if you want to replace the text with your typing).
- If the computer beeps every time you press a key, Easy Access is probably turned on.
 - Use the Extensions Manager control panel in the Control Panels folder in the Apple (🍏) menu to turn off Easy Access. For more information about Extensions Manager, see the information about managing extensions in Macintosh Guide (or Mac OS Guide), available in the Guide (🔍) menu.
- The keyboard is not connected properly.
 - Turn off the computer by pressing the power button on the front of the computer. With the computer off, check that the keyboard cable is connected properly at both ends.
- Some system software features that affect the way the keyboard works are turned on.
 - Open Easy Access from the control panels listed under the Apple (🍏) menu and turn off Sticky Keys, Slow Keys, and Mouse Keys.

- There is a software problem.

Restart your Macintosh. For instructions, see Chapter 9, “Start Here If Trouble Occurs.”

Check the startup disk and application program you were using when the problem occurred. To check that the programs and the system extensions you’re using are compatible with the system software, restart while holding down the Shift key; this temporarily turns off all system extensions. If your computer works normally after you do this, use the Extensions Manager control panel to turn on extensions and control panels one at a time.

Restart after you turn on each extension. This procedure should identify any incompatible extensions and control panels that may be causing the problem. (If you just added new software to your computer, its system extension is the most probable cause of the problem.) For detailed instructions, see the information about managing system extensions in Macintosh Guide (or Mac OS Guide), available in the Guide (🔍) menu.

If the problem reoccurs, you may need to reinstall system software. See Chapter 11, “Diagnostic Techniques,” for instructions.

- The keyboard is damaged.

If you have access to another keyboard, try using it instead. (Turn the computer off before connecting it.) If the new keyboard works, there is probably something wrong with the one you replaced.

If none of these procedures solves the problem, consult the service and support information that came with your computer for instructions on how to contact an Apple-authorized service provider or Apple for assistance.

Your screen displays a right-angle bracket prompt (>).

Your computer has tried to launch a “debugging” application, but could not find one on your hard disk. Debugging applications are programs that software developers use to locate and fix problems in computer code. If you do not have a debugging application installed, your screen displays a right-angle bracket prompt (>). To return to the desktop, type G and then press Return.

You can't record sound using an external microphone or the microphone built into your monitor.

- Make sure your sound input source is set to “External Microphone.” Open the Monitors & Sound control panel in the Apple () menu, click the Sound icon, and choose “External Microphone” from the Sound Input pop-up menu.
- If you're using your monitor's built-in microphone to record, use the Monitors & Sound control panel to mute the monitor's speakers. In the same control panel, make sure that the sound input is set to the monitor's built-in microphone.

For additional help, see the information about sound in Macintosh Guide (or Mac OS Guide), available in the Guide (🔍) menu.

The computer's clock keeps time inaccurately.

If your clock begins to keep time inaccurately, have an Apple-authorized service provider replace the battery. Consult the service and support information that came with your computer for instructions on how to contact an Apple-authorized service provider or Apple for assistance.

WARNING Do not attempt to replace the clock battery yourself. If the clock begins to lose accuracy, have an Apple-authorized service provider replace the battery. The service provider will dispose of the battery according to the local environmental guidelines.

Some icons look different from usual.

- There may be a problem with the information that the computer uses to keep track of files. To fix this problem, you need to rebuild the desktop. For instructions, see “Rebuilding Your Desktop” in Chapter 11, “Diagnostic Techniques.”
- You may be using a file-compression program to save space on your hard disk. Some compression programs change the appearance of icons.

When trying to open or move a font file, you see an error message.

- The font file may be damaged. To remove damaged font files, follow these steps:
 1. Drag the Fonts folder out of the System Folder.
 2. Restart the computer.
 3. Open the Fonts folder that you dragged out and drag all the fonts that do not cause errors to the System Folder icon. Click OK in the dialog box.
 4. Throw away the old Fonts folder.
 5. Reinstall the damaged font from the original disk.

An icon is blinking in the menu bar.

- A program needs attention. Open the menu and choose the program whose icon is blinking (it may have a diamond by its name). Respond to any messages on the screen. If it's not clear what you should do, consult the documentation that came with the program.

The computer makes unusual sounds.

- A program may need your attention. If an icon is blinking in the menu bar, open the menu, choose the program whose icon is blinking (it may have a diamond by its name), and take the necessary action.
- Open the Easy Access control panel (if it is installed on your computer) and check whether any of its features are turned on.
- Select a different system sound in the Sound control panel.
- If the sounds are regular or melodic, they may be caused by interference from electrical equipment. Move the computer farther away from any such equipment.

See also “The Computer Makes an Unusual Sound at Startup” in the section “Problems Turning On or Starting Up Your Computer” earlier in this chapter.

Problems with your printer

The following suggestions should work for all printers. (*Note:* Also refer to the manual that came with the printer.)

- Make sure that the printer driver for your printer is turned on in the Extensions Manager control panel in the Control Panels folder in the Apple () menu. To find out the name of the printer driver—for example, *LaserWriter*—refer to the documentation that came with your printer.
- Check your printer settings in the Chooser (in the Apple [] menu), making sure you have selected the correct printer. If you are using a printer that is shared by other computer users (a printer on a local network), make sure that AppleTalk (in the lower-right corner of the Chooser) is active. If you are using your own printer (a serial printer connected to your computer), make sure that AppleTalk is inactive.
- Turn off the computer and printer and check the printer cable connections.
- If none of these suggestions solves the problem, you may need to reinstall the printer driver that came with your printer. Refer to the manual that came with your printer. (See the following important note.)

Note: If you have an Apple printer, you need to determine which printer driver to reinstall—the one that came with your printer or one of the drivers included on your system software CD-ROM disc. Depending on when you bought your printer, one of these printer drivers will be more recent than the other. It is the more recent one you want.

Nothing happens, or an error message appears when you try to print.

- There may not be enough memory for printing. Try the following:
 - Quit the program immediately after sending the Print command to free up memory for printing.
 - Increase the amount of memory for the desktop printer icon; select it, choose Get Info from the File menu, and type a larger number in the Preferred Size box.
 - Reduce the amount of memory the program uses.
- Make sure the printer is turned on. Some printers need to warm up for a few minutes after you turn them on.
- The printer may be out of paper or may need attention. Check the printer status lights and any messages on your screen.
- Open the desktop printer icon and check for status messages.
- Reinstall your printer software.

Problems with networks and file sharing

If you are having problems using the network or file sharing, try the following before attempting further solutions:

- Make sure the network is working by opening the Chooser and checking for the shared disks and printers you usually use.
- Make sure that AppleTalk is turned on in the Chooser.
- Open the AppleTalk and TCP/IP control panels and make sure the settings are correct. For more information, see Chapter 5, “Connecting Your Computer to a Network.”

- Make sure that all the network software is installed. The Network and AppleShare extensions should be in the Extensions folder. If you want to use file sharing, the Sharing Setup control panel should be in the Control Panels folder, and the File Sharing extension should be in the Extensions folder. If any of these items is missing, reinstall the system software according to the instructions in Chapter 11, “Diagnostic Techniques.”

The computer you want to connect to doesn't appear in the Chooser.

- Make sure the computer you're trying to connect to is turned on.
- Make sure file sharing is active on the computer you're trying to connect to. (That computer's Sharing Setup control panel should say that file sharing is on.)

You connected to another computer, but the shared disk you want to use is not available.

- You may already be connected to the shared disk. Check for its icon on your desktop.
- You may not have the access privileges you need to use the shared disk. Ask the network administrator or the owner of the shared item to give you access. See the topic on file sharing in Macintosh Guide (or Mac OS Guide), available in the Guide (🔍) menu.

You connected to another computer, but you can't see any files.

- Make sure that files are being shared on the other computer. The File Sharing Monitor control panel on that computer lists the items being shared.
- Make sure you have the access privileges you need to view the files. Ask the network administrator or the owner of the shared item to give you access. See the topic on file sharing in Macintosh Guide (or Mac OS Guide), available in the Guide (🔍) menu.

A message says that file sharing can't be turned on.

- Make sure AppleTalk is turned on in the Chooser.
- Make sure you have at least 400K of available space on your hard disk.

- Some disk-formatting programs don't work with file sharing. If you use such a program, contact the manufacturer or vendor for compatibility information.
- There may be a problem with some of the information your computer uses to start up file sharing. Follow these steps in order until the problem is solved:
 1. Open the Sharing Setup control panel and enter new information in the Owner section. Then try again to turn on file sharing.
 2. Remove the File Sharing folder from the Preferences folder (inside the System Folder). Then restart the computer and try to turn on file sharing.
 3. Reset the PRAM and NVRAM by following the instructions in "The Computer Makes an Unusual Sound at Startup" earlier in this chapter. Afterward, make sure to select the correct network type in the AppleTalk control panel.
 4. Remove the Users & Groups data file from the Preferences folder (inside the System Folder). Restart the computer.
 5. Reinstall system software.

A message says that an item can't be shared.

- Make sure you have at least 1 MB of space available on your hard disk.
- Some removable storage devices can't be shared. Check with the manufacturer or vendor of the device for more information.
- Some disk-formatting programs don't work with file sharing. If you use such a program, check with the program's manufacturer or vendor.

The file-sharing section doesn't appear in the Sharing Setup control panel.

- You may have turned off AppleTalk or file sharing using the Extensions Manager control panel. Turn them back on.
- If the file-sharing and network software are not in your System Folder, reinstall them by reinstalling system software. For more information, see Chapter 11, "Diagnostic Techniques."

You can't open a shared disk or folder.

- You may not have the access privileges needed to use the disk or folder. Ask the network administrator or the owner of the shared item to give you access.
- Check with the owner of the item to make sure you are entering your name exactly as the owner specified (including spaces and capitalization) and try again.

Consult this chapter to learn how to check system extensions, test and repair hard disks, install and remove system software, and use other diagnostic techniques.

11

Diagnostic Techniques

This chapter provides detailed instructions on several techniques you will use to diagnose and fix problems involving system software and hard disks. You will learn how to check your system extensions, start up from your system software CD-ROM disc, and test and repair disks. You will also see different ways to install and remove system software and learn how to use Apple System Profiler, a utility that allows you to quickly view different types of information about your computer.

Checking your system extensions

System extensions are files that add features to your system software. Some extensions are incompatible with one another, with certain programs, or with Macintosh computers built with the PowerPC microprocessor. To check whether an extension is causing problems, follow these steps:

- 1 **Start up your computer while holding down the Shift key. Keep it held down until you see the message “Extensions off” in the Welcome to Macintosh box.**

This procedure turns off all extensions.

If your computer starts up and runs normally, continue with this section. If it doesn't, turn to the next section, “Testing and Repairing Your Hard Disk.”

2 Turn off troublesome extensions using the Extensions Manager control panel.

For more information about Extensions Manager, see Macintosh Guide (or Mac OS Guide), available in the Guide (🔍) menu.

Tips for locating problem extensions:

- If you recently installed a new item in the System Folder, it may be causing the problem. If you recently installed a new application program, a new extension may have been installed along with it. Check for new items in the Extensions folder and Control Panels folder. Also check for items of the kind “extension” or “control panel” in the System Folder itself.
- If two of your extensions provide similar features (such as two screen savers or two clocks), they may be incompatible with each other. Remove one of the extensions.
- If the computer is freezing or displaying an error message before it finishes starting up, restart the computer and take note of the icons that appear at the bottom of the screen. Many extensions display an icon as they start up, and extensions start up alphabetically. The last extension that displays an icon, or the one after it alphabetically, may be the problem extension.

3 Turn extensions back on, one extension at a time, in the Extensions Manager control panel. Restart the computer after turning on each extension and test to see if the problem reoccurs.

When you have located the problem extension, remove it from the System Folder and contact the developer or vendor for compatibility information.

4 Go to the next section if you are still having problems.

Testing and repairing your hard disk

If you see a message reporting that a disk is damaged or unreadable, you may need to repair the disk.

Try these suggestions first

If you can't start up from a hard disk or you don't see the hard disk icon on the desktop, try the following:

- If the hard disk is internal, shut down your Macintosh, wait at least 10 seconds, and then turn it on again.
- If the hard disk is external, shut down your Macintosh, make sure that the hard disk is turned on, and that its cable is connected firmly; then restart the Macintosh.
- If the hard disk is your startup disk, start up with a different startup disk. (See “Starting Up From the System Software CD-ROM Disc,” later in this chapter.)

If, after you start up from a different disk, your hard disk's icon appears on your desktop, reinstall system software on the hard disk. See “Installing System Software” later in this chapter.

- Check the ID numbers of all SCSI equipment (anything connected to the SCSI port [⌘]) on your computer. For information on setting SCSI ID numbers and terminating a SCSI chain, see both the manuals that came with your SCSI equipment and Chapter 7, “Connecting Additional Equipment.”
- If none of these suggestions solves the problem, test the disk by following the instructions given in “Testing for Damage on Your Hard Disk,” which follows.

Testing for damage on your hard disk

You can test a hard disk for damage with the Drive Setup program, which is on the system software CD-ROM disc that came with your computer.

- 1 **Start up your computer from the system software CD-ROM disc that came with your computer.**

See “Starting Up From the System Software CD-ROM Disc” later in this chapter.

- 2 **Locate the Drive Setup icon and double-click it to open the Drive Setup program.**



- 3 **In the list of drives, click the disk you want to test.**

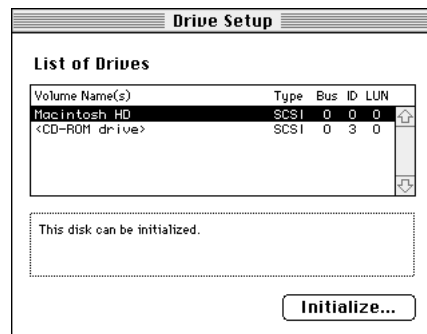

- 4 **From the Functions menu, choose Test Disk.**
- 5 **When a message tells you that the testing is complete, click Quit.**

If the test reveals a problem, you may be able to correct it by using Disk First Aid or another disk repair program (see the instructions in the next section) or you may need to reinitialize the disk (see “Initializing a Hard Disk” later in this chapter). Consult an Apple-authorized service provider for assistance if necessary. If you had a hard disk from another manufacturer installed after you bought your computer, use the software that came with the disk or contact the disk vendor to get the latest version of software.

Repairing a damaged disk

You can repair some types of disk damage by using the Disk First Aid program, which is on the system software CD-ROM disc that came with your computer.

- 1 **Start up your computer from the system software CD-ROM disc that came with your computer.**

See “Starting Up From the System Software CD-ROM Disc” later in this chapter.

- 2 **Locate the Disk First Aid icon and double-click it to open the Disk First Aid program.**



Disk First Aid

- 3 **Click the icon of the disk you want to test.**

Disk icons appear in a box at the top of the Disk First Aid window.

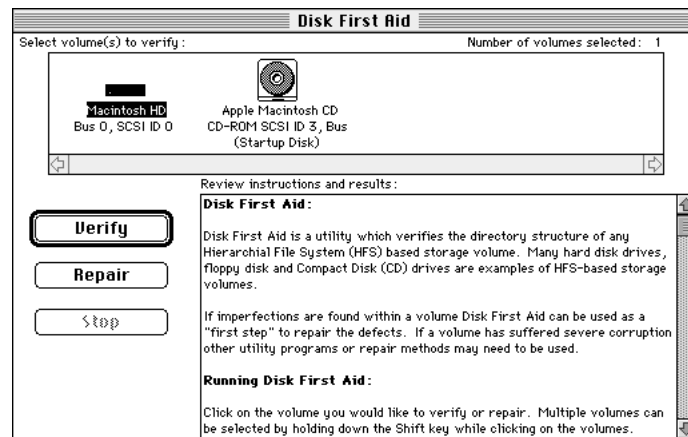

4 Click Repair to begin testing and repairing the disk.

You can't repair the startup disk or the disk that contains the Disk First Aid program, but you can test these disks by clicking Verify. If the program reveals a problem with either of these disks, start up the computer from another disk so that you can repair the damaged disk.

If you want to test and repair another disk, click its icon and then click Repair.

5 When testing and repair are done, choose Quit from the File menu.

If Disk First Aid cannot correct the problem

- Try repairing the disk again. Sometimes repeating the process corrects the problem.
- Use another disk repair or recovery program. Some disk repair programs let you recover information from a damaged disk.
- Consult an Apple-authorized service provider for help.
- If you can't repair the disk, you'll need to reinitialize it, which erases all the information on it. Before you reinitialize, be sure you recover all the information you can and back it up. Then erase (reinitialize) the disk. For instructions on reinitializing a floppy disk, see Macintosh Guide (or Mac OS Guide), available in the Guide (🔍) menu. For instructions on reinitializing a hard disk, see the next section, "Initializing a Hard Disk."

If reinitialization doesn't work, discard the damaged disk (if it's a floppy disk) or take it to your Apple-authorized service provider for repair (if it's a hard disk). Bring your system software CD-ROM disc with you to the service provider.



Initializing a hard disk

The hard disk inside your computer was initialized (formatted for use) at the factory, so you shouldn't need to initialize it. You need to initialize a hard disk only if one of the following is true:

- You purchase an uninitialized hard disk from another manufacturer.
- Your hard disk is damaged and can't be repaired with Disk First Aid.

If a hard disk needs to be initialized, its icon does not appear on the desktop when you start up the computer using another disk.

You initialize your internal hard disk using a program called Drive Setup, which is on the system software CD-ROM disc that came with your computer.

WARNING Initializing a disk erases any information that may be on it. Before you initialize a damaged disk, try to repair it as described in “Repairing a Damaged Disk” earlier in this chapter.

- 1 Start up your computer from the system software CD-ROM disc that came with your computer.**

See “Starting Up From the System Software CD-ROM Disc” later in this chapter.

- 2 Locate the Drive Setup icon and double-click it to open the Drive Setup program.**



Drive Setup

- 3 In the list of drives, click the disk you want to initialize.

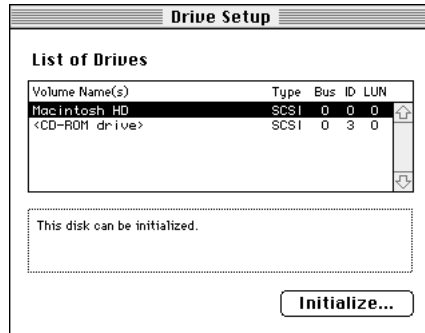

- 4 Click Initialize to initialize the hard disk.
- 5 Click Quit when you see a message reporting that initialization was successful.

If a message reports that initialization failed, try again. If initialization fails a second time, take the disk to your Apple-authorized service provider for repair.

Starting up from the system software CD-ROM disc

To test, repair, or initialize a hard disk, or to install or remove system software on a hard disk, you need to start up your computer from another disk. You can start up your computer using the system software CD-ROM disc.

The procedure for starting up from the CD-ROM disc varies depending on the condition of the system software on your hard disk. To find out which procedure to use, you must turn on your Macintosh.

The steps that follow tell how to start up from a CD-ROM disc, depending on what you see on your screen.

If you see a blinking question mark on your screen

The blinking question mark means that your Macintosh is unable to find usable system software on your hard disk.



- 1 Press the Open/Close button of your CD-ROM drive to open the CD-ROM tray.
- 2 Place the CD-ROM disc in the tray with the disc label facing up.
- 3 To close the tray, push the tray in or press the Open/Close button.

Your Macintosh recognizes the CD-ROM disc as a startup disk, and in a few seconds the Macintosh desktop appears.

If you see the Macintosh desktop

- 1 Press the Open/Close button of your CD-ROM drive to open the CD-ROM tray.
- 2 Place the CD-ROM disc in the tray with the disc label facing up.
- 3 To close the tray, push the tray in or press the Open/Close button.
- 4 Hold down the C key on your keyboard while you choose Restart from the Special menu.

Continue to hold down the C key until you see the “Welcome to Macintosh” message.

Installing system software

Your Macintosh came with all the necessary system software installed on its internal hard disk, so you don't need to install system software on that disk unless you encounter software problems.

When should you install system software?

- You have a new hard disk or a newly initialized hard disk that does not yet contain system software. Follow the instructions in “Performing a Normal or Easy Installation of System Software” later in this section.
- You want to upgrade to a more recent version of system software. Follow the instructions that came with your system software upgrade, or the ones in “Performing a Normal or Easy Installation of System Software” later in this section.

IMPORTANT If you're having a problem with your system software, you may not need to reinstall system software. If you see an icon like this in the middle of the screen, follow the instructions in “Testing and Repairing Your Hard Disk” earlier in this chapter to test your startup hard disk and repair any damage.



If repairing the disk doesn't help, follow the instructions that follow to reinstall system software on your startup hard disk.

Performing a normal or easy installation of system software

Follow the steps in this section to do what is commonly called a “normal” or easy installation of system software.

If you’re installing system software on a hard disk for the first time, make sure that your hard disk has been initialized, a process that prepares the disk to store information. If you see the hard disk’s icon on the desktop when you start up the computer, the disk has been initialized. If no disk icon appears when you start up, see the section “Initializing a Hard Disk” earlier in this chapter for instructions.

To perform a normal installation, follow these steps:

- 1 Start up your computer from the CD-ROM disc that contains system software.**

Do this by inserting the CD-ROM disc into the CD-ROM drive and holding down the C key while you restart the computer. For detailed steps, see “Starting Up From the System Software CD-ROM Disc” earlier in this chapter.

- 2 Find and open the Disk First Aid icon.**

You may need to look in a folder called Utilities to find Disk First Aid.



Disk First Aid

After Disk First Aid starts, follow the instructions on the screen to verify your disk. Disk First Aid checks your hard disk for any problems.

- 3 When the verification process stops, check the results in the Disk First Aid window.**

If the results indicate that your hard disk appears to be OK, choose Quit from the File menu. If Disk First Aid finds a problem, see “Repairing a Damaged Disk” in the section “Testing and Repairing Your Hard Disk,” earlier in this chapter.

- 4 Find and open the Drive Setup icon.



You use the Drive Setup program to update your hard disk. You may need to look in a folder called Utilities to find Drive Setup.

- 5 In the list of drives, click your startup disk.
- 6 Choose Update Driver from the Functions menu.
- 7 When the update process is finished, quit Drive Setup.
- 8 Shut down your computer.
- 9 Start up your computer from the CD-ROM disc that contains system software.

Do this by inserting the CD-ROM disc into the CD-ROM drive and holding down the C key while you restart the computer. For detailed steps, see “Starting Up From the System Software CD-ROM Disc” earlier in this chapter.

- 10 Find and open the Install System Software icon.



Install System Software

The Installer’s “welcome” screen appears.

11 Click Continue.

The Easy Install dialog box appears.

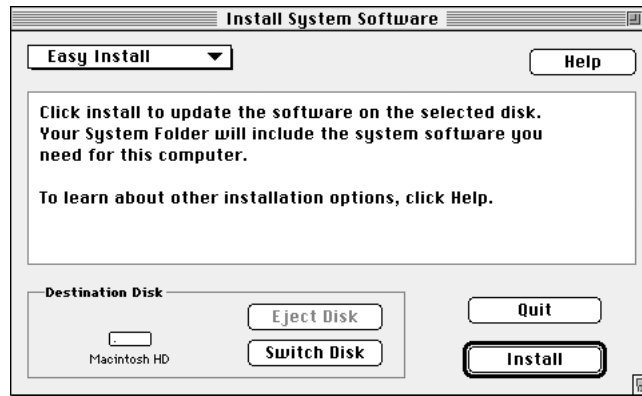

12 Make sure that the hard disk named in the Destination Disk box is the one on which you want to install system software.

If it isn't, click Switch Disk until the correct disk name appears.

13 Click Install.

14 Follow the onscreen instructions.

15 When you see a message reporting that the installation was successful, click Restart.

If your computer does not start up properly, see “If the Installation was not Successful,” next.

16 If necessary, install or reinstall other software that may be missing from your startup disk.

If you erased your hard disk prior to installing system software, certain system extensions or application programs that were originally on your hard disk may need to be reinstalled. Some additional extensions and programs are on the CD-ROM disc that contains system software. System extensions or application programs from other vendors can be reinstalled from their installation disks.

If the installation was not successful

If a message reports that installation was not successful, try installing again. (Follow the instructions on the screen.)

If, after reinstalling system software by doing a normal installation, you still experience problems with your computer, follow the steps in the next section for performing a “clean” installation of system software.

Performing a clean installation of system software

This section outlines what is commonly called a “clean” installation of system software. A clean installation allows you to discover which item in your System Folder is causing a problem. A clean installation creates a brand new System Folder and saves everything in your original System Folder in a different location. You can then follow the instructions in “Replacing Your Special Software” later in this section to reinstall system extensions, control panels, and other special software one at a time from the old System Folder to the new System Folder. This procedure allows you to determine which item in the old System Folder was the source of the problem.

Perform a clean installation if you can't determine what is damaged in your System Folder (especially if you think any special software, such as control panels, system extensions, or custom utilities, may be causing the problems you're experiencing). You should also perform a clean installation if you're still having problems with your computer after you've reinstalled system software by performing a normal installation.

To perform a clean installation, follow these steps:

1 Start up your computer from the CD-ROM disc that contains system software.

Do this by inserting the CD-ROM disc into the CD-ROM drive and holding down the C key while you restart the computer. For detailed steps, see “Starting Up From the System Software CD-ROM Disc” earlier in this chapter.

2 Find and open the Disk First Aid icon.

You may need to look in a folder called Utilities to find Disk First Aid.



Disk First Aid

After Disk First Aid starts, follow the instructions on the screen to verify your disk. Disk First Aid checks your hard disk for any problems.

3 When the verification process stops, check the results in the Disk First Aid window.

If the results indicate that your hard disk appears to be OK, choose Quit from the File menu. If Disk First Aid finds a problem, see “Repairing a Damaged Disk” earlier in this chapter.

4 Find and open the Drive Setup icon.



Drive Setup

You use the Drive Setup program to update your hard disk. You may need to look in a folder called Utilities to find Drive Setup.

5 In the list of drives, click your startup disk.

6 Choose Update Driver from the Functions menu.

7 When the update process is finished, quit Drive Setup.

8 Shut down your computer.

9 Start up your computer from the CD-ROM disc that contains system software.

Do this by inserting the CD-ROM disc into the CD-ROM drive and holding down the C key while you restart the computer. For detailed steps, see “Starting Up From the System Software CD-ROM Disc” earlier in this chapter.

- 10 Find and open the Install System Software icon.



The Installer's "welcome" screen appears.

- 11 Click Continue.

The Easy Install dialog box appears.

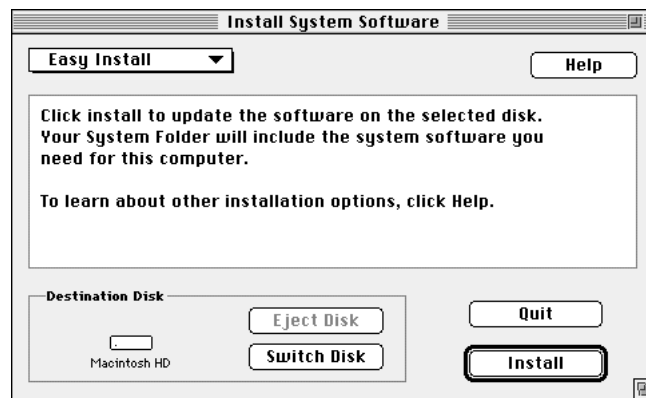

- 12 Make sure that the hard disk named in the Destination Disk box is the one on which you want to install system software.

If it isn't, click Switch Disk until the correct disk name appears.

- 13 Press Shift-⌘-K.

The following dialog box appears.



- 14 Click the **Install New System Folder** button and click **OK**.

The Easy Install dialog box appears. The Install button has changed to Clean Install, and the contents of your old System Folder have been moved to a new folder named Previous System Folder.

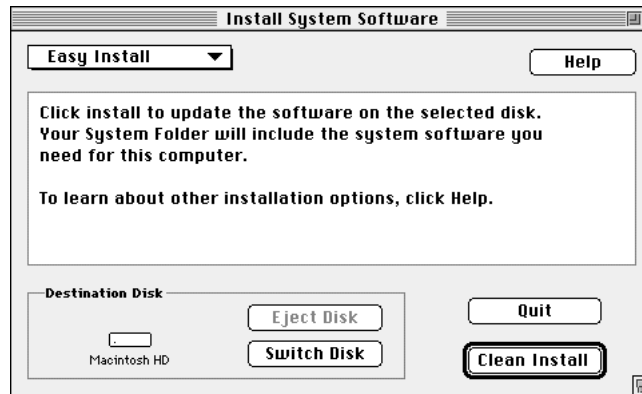

- 15 Click **Clean Install**, and follow the instructions that appear on the screen.

It takes a few minutes to complete the installation.

- 16 When the installation is complete you see a message reporting that the installation was successful.

If a Restart button appears, click it to restart your computer, and remove the system software CD-ROM disc from the CD-ROM drive.

If a message reports that installation was not successful, try repeating the clean installation procedure.

Replacing your special software

Special software consists of items such as control panels, system extensions, custom utilities, fonts, or Apple Menu Items that you may have added to your old System Folder. To make sure that special software does not create any conflicts with other programs on your computer, follow this procedure to safely add back these items in your new System Folder:

- 1 Copy any special software items from the Previous System Folder back to your System Folder one item at a time, restarting the computer after copying each item.**

IMPORTANT Be very careful not to *replace* (copy over) any of the files in the System Folder with files from the Previous System Folder.

- 2 Check after each restart to make sure your computer is not having any software problems.**

If any of your special software items cause software problems, contact the software manufacturer for assistance or an upgrade.

If you erased your hard disk prior to installing system software, certain system extensions or application programs that were originally on your hard disk may need to be reinstalled. Some additional extensions and programs are on the CD-ROM disc that contains system software. System extensions or application programs from other vendors can be reinstalled from their installation disks.

Performing a custom installation

For most Macintosh users, the Easy Install procedure described in the previous sections is appropriate because it automatically installs all the items you need. However, if you'd like to select a combination of system software files for your specific needs, you can customize your system software installation. You use custom installation to install or update one or more specific files, or to save space on your hard disk by installing only the files you want.

To install customized system software, follow these steps:

- 1 Start up your computer from the CD-ROM disc that contains system software.**

Do this by inserting the CD-ROM disc into the CD-ROM drive and holding down the C key while you restart the computer. For detailed steps, see “Starting Up From the System Software CD-ROM Disc” earlier in this chapter.

- 2 Find and open the Disk First Aid icon.**

You may need to look in a folder called Utilities to find Disk First Aid.



Disk First Aid

After Disk First Aid starts, follow the instructions on the screen to verify your disk. Disk First Aid checks your hard disk for any problems.

- 3 When the verification process stops, check the results in the Disk First Aid window.**

If the results indicate that your hard disk appears to be OK, choose Quit from the File menu. If Disk First Aid finds a problem, see “Repairing a Damaged Disk” earlier in this chapter.

- 4 Find and open the Drive Setup icon.



You use the Drive Setup program to update your hard disk. You may need to look in a folder called Utilities to find Drive Setup.

- 5 In the list of drives, click your startup disk.
- 6 Choose Update Driver from the Functions menu.
- 7 When the update process is finished, quit Drive Setup.
- 8 Shut down your computer.
- 9 Start up your computer from the CD-ROM disc that contains system software.

Do this by inserting the CD-ROM disc into the CD-ROM drive and holding down the C key while you restart the computer. For detailed steps, see “Starting Up From the System Software CD-ROM Disc” earlier in this chapter.

- 10 Find and open the Install System Software icon.



The Installer’s “welcome” screen appears.

- 11 Click Continue.
- 12 Choose Custom Install from the pop-up menu.



The Custom Install dialog box appears, listing all available system software components.

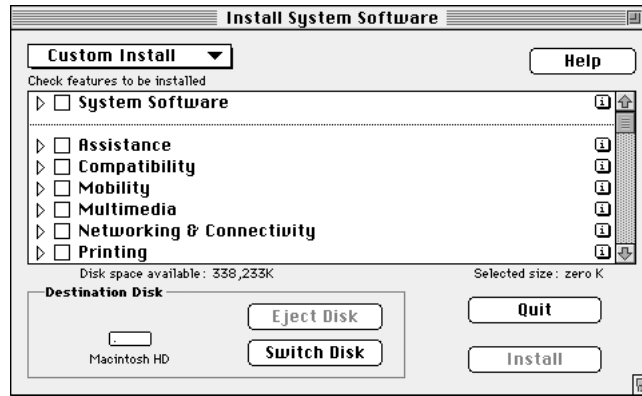

- 13 **Make sure that the hard disk named in the Destination Disk box is the one on which you want to install system software.**

If it isn't, click Switch Disk until the correct disk name appears.

- 14 **Scroll through the list of components, clicking the checkbox next to each component you want to install.**

To get additional information about each component listed, click the box with the letter *i* in it to the right of the component.

- 15 **Click Install.**
- 16 **Follow the instructions that appear on the screen.**
- 17 **When you see a message reporting that the installation was successful, click Quit.**

If a message reports that installation was not successful, try installing again. (Follow the instructions on the screen.)

- 18 **Restart your Macintosh.**

The system software is installed and your computer is ready to use. Don't forget to eject the CD-ROM disc containing system software when you are finished.

Rebuilding your desktop

A procedure known as “rebuilding the desktop” helps your Macintosh to keep accurate track of data on your startup disks. Even though rebuilding the desktop does not usually fix problems once they occur, it does prevent some types of problems. Therefore, it’s a good idea to rebuild your desktop once a month or so.

Before you rebuild the desktop, you’ll need to turn off some extensions, which may interfere with the desktop rebuilding process. You’ll turn them back on later.

To rebuild the desktop, follow these steps:

- 1** Open the Extensions Manager control panel by choosing Extensions Manager from the Control Panels submenu of the Apple () menu.
- 2** From the Sets pop-up menu, choose Save Set.
- 3** In the Save Set dialog box, type a name for your currently selected extensions (for example, “My Extensions”) and click OK. The name of your set is added to the Sets pop-up menu.

This saves your current set of extensions.

- 4** Choose All Off from the Sets pop-up menu to turn off all extensions.
- 5** Turn on Macintosh Easy Open by clicking it in the list so that a checkmark appears beside it.

You can find Macintosh Easy Open by scrolling down the list of extensions. Macintosh Easy Open appears under the heading “Control Panels.”

- 6** Restart your computer while holding down the Command (⌘) and Option keys.

Hold down the ⌘ and Option keys until you see the dialog box that asks if you’re sure you want to rebuild your desktop file. When the dialog box appears, you can release the keys.

- 7 **Click OK.**

The computer rebuilds the desktop. This can take several minutes.

IMPORTANT Do not stop the desktop-rebuilding process. Doing so could damage your system files.

- 8 **Open the Extensions Manager control panel by choosing Control Panels from the Apple (🍏) menu. When the Control Panels window appears, double-click the Extensions Manager icon.**
- 9 **From the Sets pop-up menu, choose the name you gave your set of extensions in step 3.**
This turns your original set of extensions back on.
- 10 **Restart your computer to activate the extensions.**

Appendixes

Appendix A Health, Safety, and Maintenance Tips

Appendix B Special Keys on Your Keyboard

A large, stylized graphic featuring a white, serif capital letter 'V' in the background. Overlaid on the lower portion of the 'V' is the word 'part' in a dark red, cursive script font. The entire graphic is set against a light pink background with a subtle wavy line pattern at the bottom.

V
part

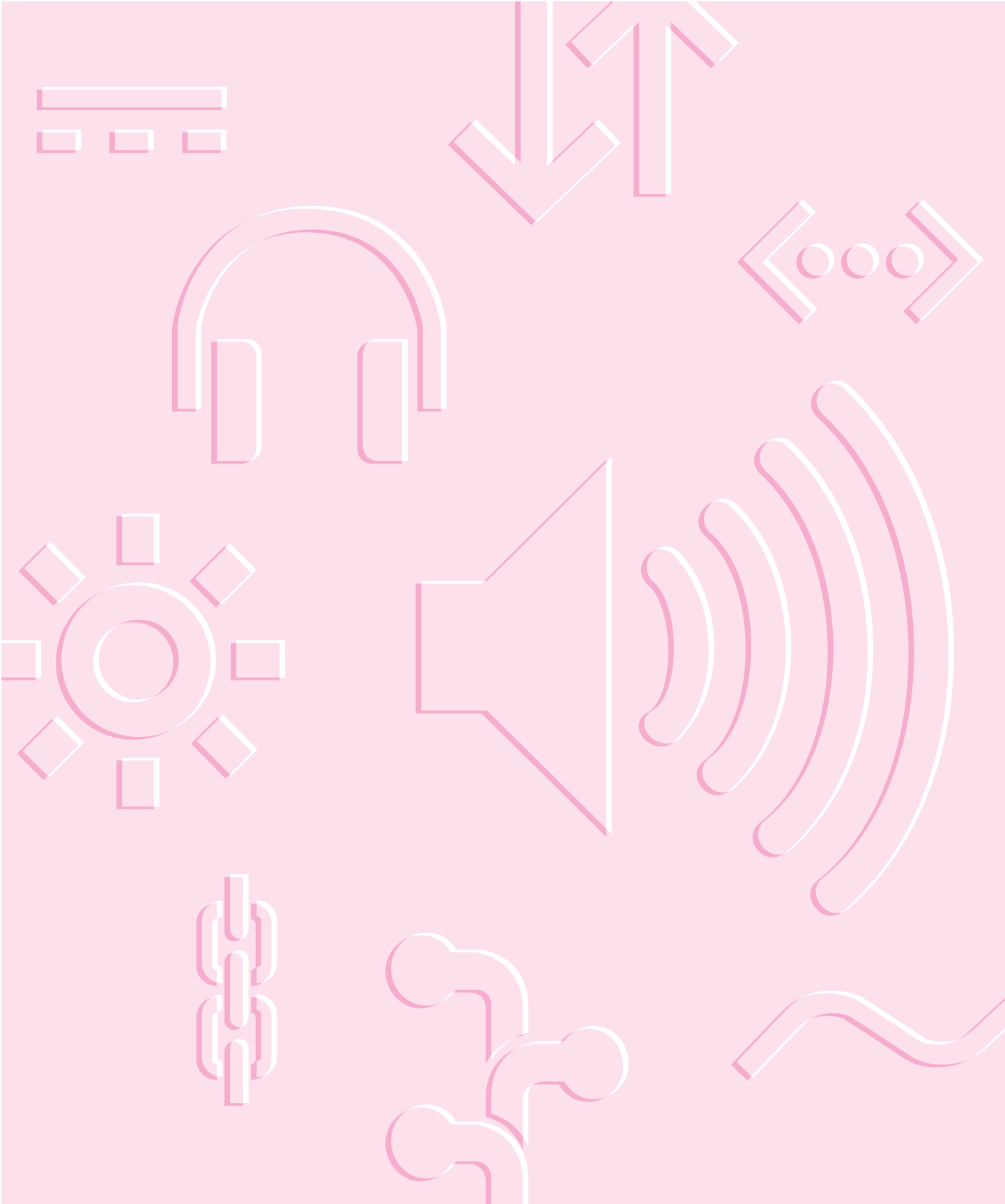

Read this appendix for important health and safety instructions, as well as tips on keeping your computer in good working order.



Appendix A Health, Safety, and Maintenance Tips



For your own safety and that of your equipment, follow all the instructions in this chapter. Keep these instructions available for reference by you and others.

Health-related information about computer use

Muscle soreness, eye fatigue, and other discomforts and injuries sometimes associated with using computers can occur from performing any number of activities. In fact, misuse of the same muscles during multiple activities can create a problem that might not otherwise exist. For example, if you engage in nonwork activities that involve repetitive stress on the wrist—such as bicycling—and also use your computer’s keyboard improperly, you may increase your likelihood of developing wrist problems. Some individuals are at greater risk of developing these problems because of their health, physiology, lifestyle, and general exposure to stress. Work organization and conditions, such as workstation setup and lighting, also play a part in your overall health and comfort. Preventing health problems is a multifaceted task that requires careful attention to the way you use your body every hour of every day.

The most common health effects associated with using a computer are musculoskeletal discomfort and eye fatigue. We’ll discuss each area of concern.

Musculoskeletal discomfort

As with any activity that involves sitting for long periods of time, using a computer can make your muscles sore and stiff. To minimize these effects, set up your work environment carefully, using the guidelines that follow, and take frequent breaks to rest tired muscles. To make working with your computer more comfortable, allow enough space in your work area so that you can change position frequently and maintain a relaxed posture.

Another type of musculoskeletal concern is repetitive stress injuries (RSIs), also known as cumulative trauma disorders (CTDs). These problems can occur when a certain muscle or tendon is repeatedly overused and forced into an unnatural position. The exact causes of RSIs are not totally understood, but in addition to awkward posture, such factors as the amount of repetition, the force used in the activity, the individual's physiology, workplace stress level, and lifestyle may affect the likelihood of experiencing an RSI.

RSIs did not suddenly arise when computers were invented; tennis elbow and writer's cramp, for example, are two RSIs that have been with us for a long time. Although less common than other RSIs, one serious RSI discussed more often today is a wrist problem called carpal tunnel syndrome, which may be aggravated by improper use of computer keyboards. This nerve disorder results from excessive pressure on the median nerve as it passes through the wrist to the hand.

This section offers advice on setting up your work area to enhance your comfort while you use your computer. Since the effects of repetitive movements associated with using a computer can be compounded by those of other work and leisure activities to produce or aggravate physical problems, proper use of your computer system must be considered as just one element of a healthy lifestyle.

No one, of course, can guarantee that you won't have problems even when you follow the most expert advice on using computer equipment. You should always check with a qualified health specialist if muscle, joint, or eye problems occur.

Eye fatigue

Eye fatigue can occur whenever the eyes are focused on a nearby object for a long time. This problem occurs because the eye muscles must work harder to view an object that's closer than about 20 feet (about 6 meters). Improper lighting can hasten the development of eye fatigue. Although eye fatigue is annoying, there's no evidence that it leads to permanent damage.

Whenever you're engaged in an activity that involves close-up work—such as reading a magazine, doing craft work, or using a computer—be sure to have sufficient glare-free lighting and give your eyes frequent rest breaks by looking up and focusing on distant objects. Remember to have your eyes examined regularly.

To prevent discomfort and eye fatigue:

- Arrange your work space so that the furniture is properly adjusted for you and doesn't contribute to an awkward working posture.
- Take frequent short breaks to give your muscles and eyes a chance to rest.

Arranging your office

Here are some guidelines for adjusting the furniture in your office to accommodate your physical size and shape.

- An adjustable chair that provides firm, comfortable support is best. Adjust the height of the chair so your thighs are horizontal and your feet flat on the floor.

The back of the chair should support your lower back (lumbar region). Follow the manufacturer's instructions for adjusting the backrest to fit your body properly.

- When you use the computer keyboard, your shoulders should be relaxed. Your upper arm and forearm should form an approximate right angle, with your wrist and hand in roughly a straight line.

You may have to raise your chair so your forearms and hands are at the proper angle to the keyboard. If this makes it impossible to rest your feet flat on the floor, you can use a footrest with adjustable height and tilt to make up for any gap between the floor and your feet. Or you may lower the desktop to eliminate the need for a footrest. Another option is to use a desk with a keyboard tray that's lower than the regular work surface.

- Position the mouse at the same height as your keyboard. Allow adequate space to use the mouse comfortably.
- Arrange the monitor so the top of the screen is slightly below your eye level when you're sitting at the keyboard. The best distance from your eyes to the screen is up to you, although most people seem to prefer 18 to 28 inches (45 to 70 cm).
- Position the monitor to minimize glare and reflections on the screen from overhead lights and windows. You may want to use a tiltable monitor stand. The stand lets you set the monitor at the best angle for viewing, helping to reduce or eliminate glare from lighting sources you can't move.

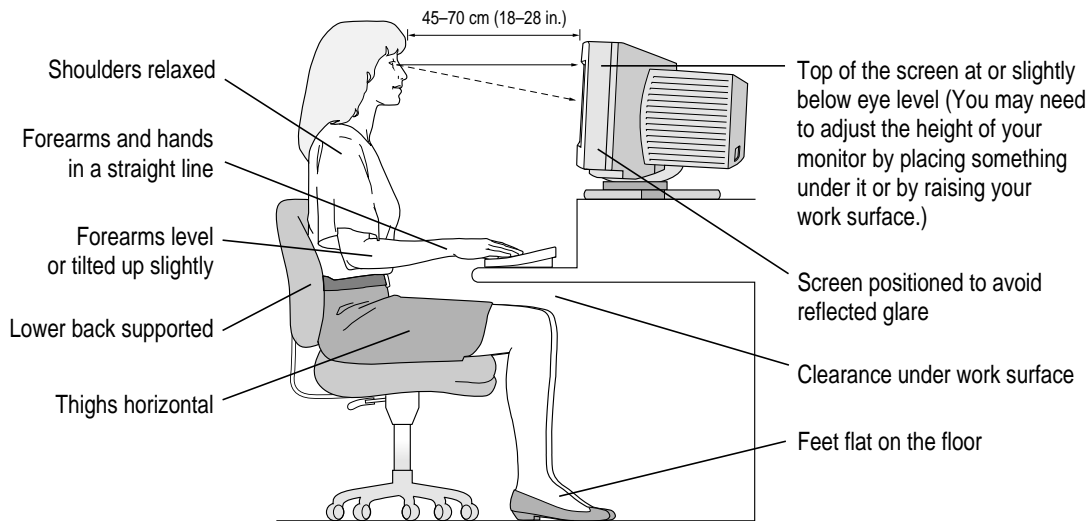

Avoiding fatigue

- Change your seated position, stand up, or stretch whenever you start to feel tired. Frequent short breaks are helpful in reducing fatigue.
- Use a light touch when typing or using a mouse and keep your hands and fingers relaxed.
- Some computer users may develop discomfort in their hands, wrists, or arms after intensive work without breaks. If you begin to develop chronic pain or discomfort in your hands, wrists, or arms, consult a qualified health specialist.
- Allow adequate work space so that you can use your keyboard and mouse comfortably. Place papers or other items so you can view them easily while using your computer. A document stand may make reading papers more comfortable.
- Eye muscles must work harder to focus on nearby objects. Occasionally focus your eyes on a distant object, and blink often while you work.
- Clean your screen regularly. Keeping the screen clean helps reduce unwanted reflections.

What about electromagnetic emissions?

There has been recent public discussion of the possible health effects of prolonged exposure to extremely low frequency (ELF) and very low frequency (VLF) electromagnetic fields. Such fields are associated with electromagnetic sources such as television sets, electrical wiring, and some household appliances—as well as computer monitors.

Apple has reviewed scientific reports and sought the counsel of government regulatory agencies and respected health organizations. Based on the prevailing evidence and opinions, Apple believes that the electric and magnetic fields produced by computer monitors do not pose a health risk.

In response to those customers who wish to reduce their exposure to electromagnetic fields, Apple has lowered the emission levels of our products. We are also actively encouraging further scientific research so we can continue to promote the health and safety of our customers and employees.

Safety instructions

For your own safety and that of your equipment, always take the following precautions.

Turn off the computer completely and disconnect the power plug (by pulling the plug, not the cord) if any of the following conditions exists:

- the power cord or plug becomes frayed or otherwise damaged
- you spill something into the case
- your Macintosh is exposed to rain or any other excess moisture
- your Macintosh has been dropped or the case has been otherwise damaged
- you suspect that your Macintosh needs service or repair
- you want to clean the case (use only the recommended procedure described later in this chapter)

Be sure that you always do the following:

- Read all the installation instructions carefully before you plug your Macintosh into a wall socket.
- Keep these instructions handy for reference by you and others.
- Follow all instructions and warnings dealing with your system.
- Keep your Macintosh away from sources of liquids, such as washbasins, bathtubs, shower stalls, and so on.
- Protect your Macintosh from dampness or wet weather, such as rain, snow, and so on.

WARNING Electrical equipment may be hazardous if misused. Operation of this product, or similar products, must always be supervised by an adult. Do not allow children access to the interior of any electrical product and do not permit them to handle any cables.

Handling your computer equipment

Follow these guidelines for handling your computer and its components:

- When setting up your computer, place components on a sturdy, flat surface, and carefully follow all setup instructions.
- When connecting or disconnecting a cable, always hold the cable by its connector (the plug, not the cord).
- Turn off your computer and all its components before connecting or disconnecting any cables to add or remove any component. Failure to do so could seriously damage your equipment.
- Never force a connector into a port. If the connector and port do not join with reasonable ease, they probably don't match. Make sure that the connector matches the port and that you have positioned the connector correctly in relation to the port.
- Take care not to spill any food or liquid on the computer, keyboard, mouse, or other components. If you do, turn your computer off immediately and unplug it before cleaning up the spill. Depending on what you spilled and how much of it got into your equipment, you may have to bring your equipment to an Apple-authorized service provider.
- Protect the computer and its components from direct sunlight and rain or other moisture.
- Keep all ventilation openings clear and unobstructed. Without proper air circulation, components can overheat, causing damage or unreliable operation.

WARNING This equipment is intended to be electrically grounded. Your Macintosh is equipped with a three-wire grounding plug—a plug that has a third (grounding) pin. This plug will fit only a grounded AC outlet. This is a safety feature. If you are unable to insert the plug into the outlet, contact a licensed electrician to replace the outlet with a properly grounded outlet. Do not defeat the purpose of the grounding plug!

Handling the monitor

Follow these procedures for handling a monitor:

- Make sure that the ventilation openings on the computer and the monitor are clear and unobstructed.
- If your computer is a desktop model, some large monitors cannot safely be placed on top of it. See Chapter 1, “Setting Up Your Computer,” for information about the maximum monitor weight your computer can support.
- If there is interference on the monitor’s screen or on a television or radio near your computer, move the affected equipment farther away.

Handling the keyboard

Take care not to spill any liquid on the keyboard. If you do, turn off your computer immediately.

- If you spill liquid that is thin and clear, unplug the keyboard, turn it upside down to let the liquid drain out, and let it dry for 24 hours at room temperature. If, after you take these steps, the keyboard doesn’t work, take it to an Apple-authorized service provider for repair.
- If you spill liquid that is greasy, sweet, or sticky, unplug the keyboard and take it to an Apple-authorized service provider for repair.

Handling floppy disks

Follow these procedures for handling floppy disks.

Store disks at temperatures between 50° F and 125° F.

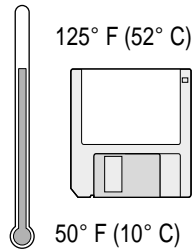

Do not use a pencil or an eraser on a disk or disk label.

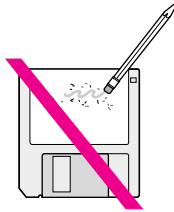

Keep disks dry.

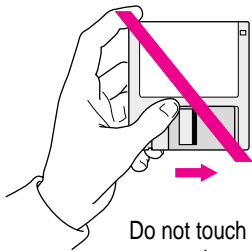
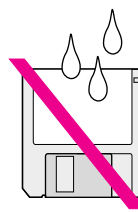

Do not touch the exposed part of the disk behind the metal shutter.

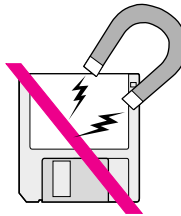

Keep disks away from magnets.

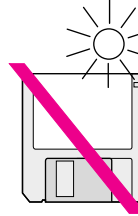

Avoid exposing disks to extremely hot temperatures.

Handling CD-ROM discs

Keep these important safety instructions in mind as you use CD-ROM discs:

- Hold a disc by the edges or by one edge and the center hole. Do not touch the disc surface.
- To clean discs, wipe the shiny surface with a soft damp cloth, working in straight lines from center to edge. Do not use any form of cleaning agent.
- To avoid damage to your discs, keep these points in mind:

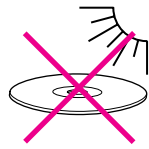

Do not expose discs to direct sunlight.

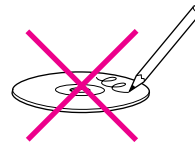

Do not write on discs.



Do not spill liquids on discs.

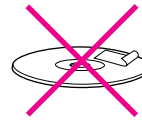

Do not put tape on discs.

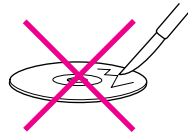

Do not scratch discs.



Do not get dust on discs.

Other important safety instructions to keep in mind as you use your CD-ROM drive.

- Position your computer so that when the tray opens, it doesn't bump into anything.
- Do not leave the disc tray open. If dust gets on the lens of the CD-ROM drive, the drive may have problems reading your compact discs.
- Do not put anything (for instance, a cup) on top of the tray when it is open.
- Do not force the tray open by hand.
- Do not wipe the lens with a paper towel or other abrasive surface. If you need to clean the lens, see an Apple-authorized service provider for a lens cleaner.

- Never transport your computer with a disc inside the CD-ROM drive.
- Keep your computer equipment away from any source of liquid (such as washbasins, bathtubs, and shower stalls). If you drink coffee or other beverages while you're at your computer, take care not to spill.
- Avoid exposing your equipment to damp or wet weather. If your system is near a window, be sure the window is closed in rainy weather.

The tray on your CD-ROM drive automatically closes when you shut down your computer. You should remove any CD-ROM disc in the CD-ROM drive before shutting down. To eject a CD-ROM disc, select the CD-ROM disc icon and choose Put Away from the File menu. (You can also drag the CD-ROM disc's icon to the trash.)

Ejecting a floppy disk

To eject a floppy disk, select the disk icon and choose Put Away from the File menu. (You can also drag the disk's icon to the trash.)

If you can't eject a floppy disk

If you can't eject a floppy disk in the usual way, try the following in order:

- Hold down the ⌘ and Shift keys and press the number 1 key at the upper left of your keyboard to eject a disk in the internal disk drive.
- Turn off the computer. If the disk isn't ejected, then hold down the button on your mouse or other pointing device while you turn the computer on again.
- Locate the small hole near the disk drive's opening, and carefully insert the end of a large straightened paper clip into it. Push gently until the disk is ejected. Do not use excessive force.

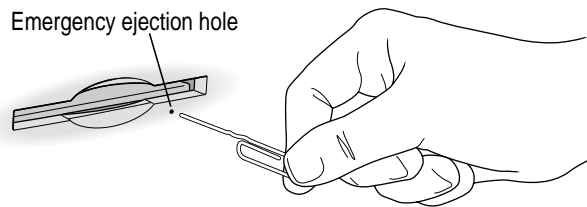

If nothing works, take the computer or disk drive to your Apple-authorized service provider to have the disk removed.

Power supply

The power supply in your computer is a high-voltage component and should not be opened for any reason, even when the computer is off. If the power supply needs service, contact your Apple-authorized dealer or service provider.

WARNING To protect the power supply from damage, make sure the voltage switch on the back of the computer is set correctly before you plug the computer into a power outlet. Refer to Chapter 1 for instructions on setting the voltage switch.

Cleaning your equipment

Follow these general rules when cleaning the outside of your computer and its components:

- Use a damp, soft, lint-free cloth to clean the computer's exterior. Avoid getting moisture in any openings.
- Don't use aerosol sprays, solvents, or abrasives.

Cleaning the computer case

To clean the case, do the following:

- 1 Turn off the computer completely and then disconnect the power plug. (Pull the plug, not the cord.)
- 2 Wipe the surfaces lightly with a clean, soft cloth dampened with water.

Cleaning the monitor

To clean the screen, put household glass cleaner on a soft cloth and wipe the screen. Don't spray the cleaner directly on the screen, because the liquid might drip into the monitor or computer.

Cleaning the mouse

The mouse contains a small ball that must roll smoothly for the mouse to work properly. You can keep this ball free of dirt and grease by using the mouse on a clean, lint-free surface and cleaning it occasionally.

You need a few cotton swabs and a clean, soft, lint-free cloth.

- 1 Turn off your computer.**
- 2 Turn the mouse upside-down and turn the plastic ring on the bottom counterclockwise to disengage it.**

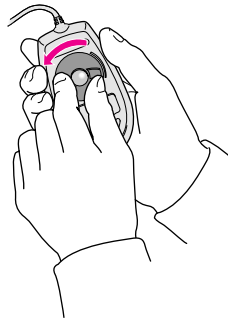

On some mouse devices, you may need to press the plastic ring (rather than turn it) to disengage it.

If the mouse is locked, see the next section, “Locking and Unlocking the Mouse,” for instructions on how to unlock it.

- 3 Turn the mouse right-side up with one hand and catch the ring and the ball with your other hand.**

- 4 Clean the three small rollers inside the mouse with a cotton swab moistened with water.**
Rotate the rollers to clean all around them.

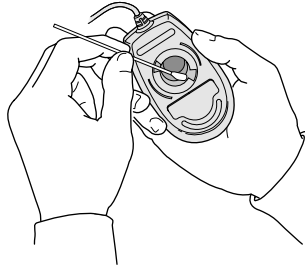

- 5 Wipe the mouse ball with a clean, soft, dry, and lint-free cloth.**
- 6 If necessary, wash the mouse ball with warm soapy water (use a mild soap such as a dishwashing liquid) and then dry the mouse ball thoroughly.**
- 7 Gently blow into the mouse case to remove any dust that has collected there.**
- 8 Put the ball and the ring back in place.**

Your mouse should roll smoothly across your mouse pad or desk. If it doesn't, repeat these instructions carefully.

Locking and unlocking the mouse

Some mouse devices can be locked so that the ball can't be removed. A locking mouse has a small hole on the plastic ring.

To lock the mouse, follow these steps:

- 1 **Insert a straightened paper clip into the hole on the plastic ring.**

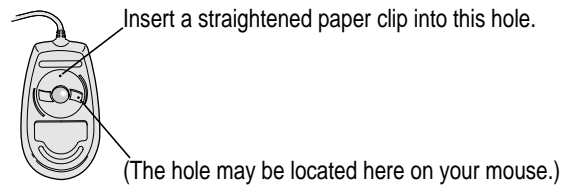

- 2 **Press down on the paper clip while you turn the ring clockwise.**

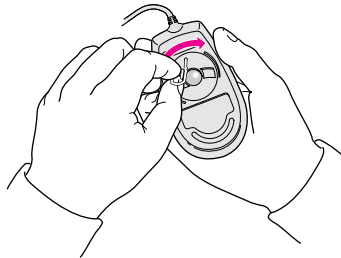

Turn the ring a very short distance, until it stops. When the recessed area on the ring is *not* lined up with the recessed area surrounding the ring, the mouse is locked.

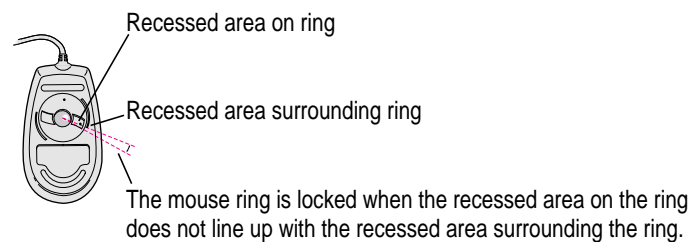

To unlock the mouse, follow these steps:

- 1 Insert a straightened paper clip into the hole on the plastic ring.**

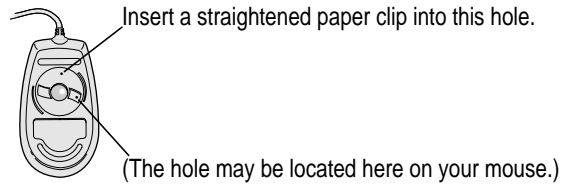

- 2 Press down on the paper clip while you turn the ring counterclockwise.**

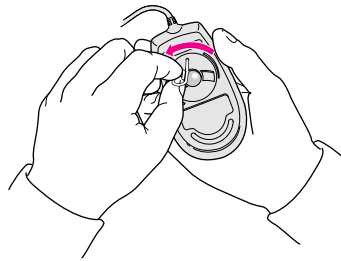

Turn the ring a very short distance. When the recessed area on the ring is lined up with the recessed area surrounding the ring, the mouse is unlocked.

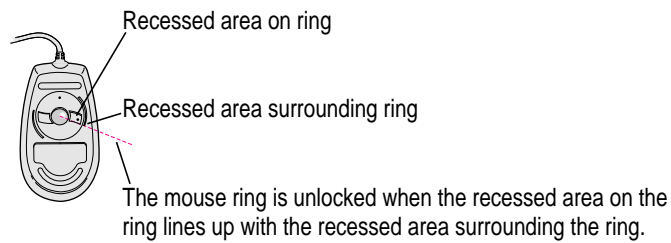





Read this appendix to learn how to use the special keys on your keyboard.

Appendix B Special Keys on Your Keyboard

Your computer keyboard contains certain special keys that typewriter keyboards don't have. Many of these keys allow you to give commands to the computer without using the mouse. For example, in many application programs, pressing the ⌘ (Command) key at the same time as the Q key lets you quit a program.













The following table describes what you can do with the special keys on your keyboard. The special keys on your keyboard depend on the model of keyboard you have; some keyboards do not have all the keys listed.

Special keys on Apple keyboards

Arrow keys		Use to move the insertion point, as an alternative to using the pointer. In some programs, the arrow keys have other functions.
Caps Lock key		Use to capitalize a series of letters (numbers and symbols aren't affected).
Clear key		Use to delete the current selection (or use the Delete key). In some programs, Clear has other functions.
⌘ (Command) key		Use in combination with other keys as an alternative to choosing a menu command.

continued ►

Special keys on Apple keyboards *(continued)*

Control key		In combination with other keys, this key provides shortcuts or modifies other actions.
Delete key		Use to delete selected material, or the character to the left of the insertion point.
Enter key		In a dialog box, pressing Enter is the same as clicking the outlined button. In some programs, pressing this key confirms information you have provided.
Escape key		The function of this key depends on the program you're using.
Function keys		Some programs allow you to use the 12 function keys to give commands. You can assign commands or action sequences to function keys with special utility programs.
Option key		Use in combination with other keys to produce special characters or modify actions.
Numeric keys		Use to produce numbers and mathematical symbols; some programs use these keys as function keys to initiate actions.
Power key		On some models, press to turn on the computer. Also press to shut down the computer on certain models.
Return key		Use to move the insertion point to the beginning of the next line. In a dialog box, pressing Return is the same as clicking the outlined button.
Shift key		Use to produce capital letters (or the upper character on the key).
Tab key		Use to move the insertion point to the next stopping place (such as a tab stop or field in a dialog box or program).
Other special keys		The function of these keys depends on the operating system and program you're using.

Typing special characters and symbols

You can type a variety of international and other special symbols and characters (including characters with diacritical marks, such as accents) by pressing combinations of keys.

The Key Caps program, which is installed with your system software, shows you the characters produced when you type certain keys and key combinations in the fonts available on your computer. Choose Key Caps from the Apple (🍏) menu, then choose the font from the Key Caps menu.

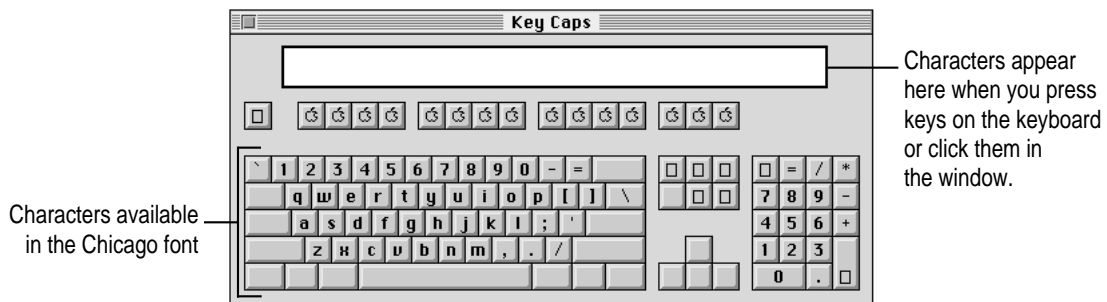

To have Key Caps show more options for special characters, press each of these keys or key combinations: Option, Shift, Shift-Option, Shift-⌘, and Option-⌘.

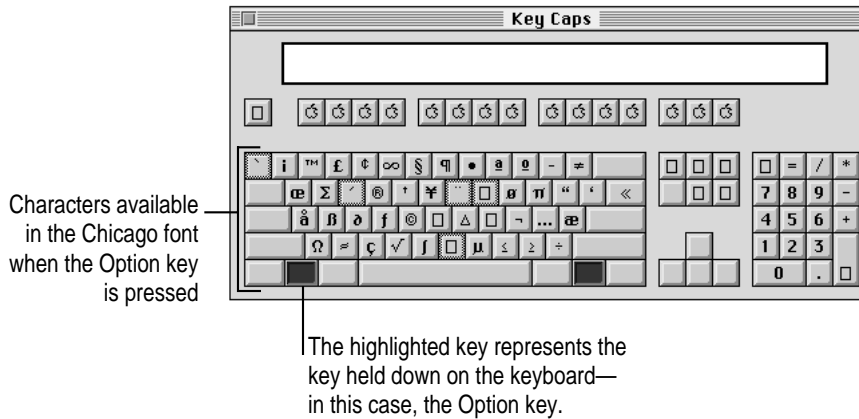

If you press the Option key, Key Caps outlines lightly the keys that you can use in combination with letter keys to type letters with accents or other diacritical marks.

Note: If you see rectangles instead of diacritical marks on some of the pictures of keys in Key Caps, try pressing Option-⌘ to see the diacritical marks. However, use the Option key (not Option-⌘) in combination with the other keys to type letters with diacritical marks.

If you press the Option key at the same time as a key for a specific diacritical mark and then release both keys, Key Caps outlines in bold the keys for letters that can be typed with that mark. (You'll see that most key combinations for diacritical marks can be used with the Space bar as well as letter keys—producing the mark without a letter.)

The most common diacritical marks and how to create them are summarized next.

Diacritical mark	Key combination
Grave accent (`)	Option-` , then type the character
Acute accent (´)	Option-e, then type the character
Circumflex (^)	Option-i, then type the character
Tilde (~)	Option-n, then type the character
Umlaut (¨)	Option-u, then type the character
The letter "c" with a cedilla (ç)	Option-c

- **To type a letter or a space with a specific diacritical mark, press the Option key and the key for the mark simultaneously. Then type the letter that needs the mark.**

If you are having trouble getting a mark and letter to appear together, try again. Be sure to press the Option key before (or at the same time as) the key for the mark; then, after you release both keys, type the letter to be marked.

Special key combinations

If difficulties with your mouse or computer don't allow you to use standard methods of quitting a program or restarting your computer, you can try using these special key combinations.

To do this press this key combination
Force a program to quit	⌘-Option-Esc
Force the computer to restart	⌘-Control-Power key

Here are other key combinations you may find useful to use while starting up your computer.

To do the following at startup...	... press this key combination
Start the computer from a CD-ROM disc	C key
Bypass the internal hard disk and start the computer from a System Folder on another drive	⌘-Option-Shift-Delete
Turn off system extensions	Shift key
Start the Extensions Manager	Space bar



Can't Find It? See also Macintosh Guide's onscreen index. Open the Guide (Ⓜ) menu and choose Macintosh Guide; then click the Index button.

Index

- ⌘ (Command)-Control-Power keys, to restart the computer 129, 219
- ⌘ (Command)-key 215
- ⌘ (Command)-Option-Esc keys, to force a program to quit 141, 164, 219
- ⌘ (Command)-Option-keys, to rebuild the desktop 194
- ⌘ (Command)-Option-R-P keys, to reset PRAM and NVRAM 135
- ⌘ (Command)-period keys, to cancel the current operation 129, 144
- ⌘ (Command)-Shift-I keys, to eject a floppy disk 158, 209
- ⌘ (Command)-Shift-Delete keys, to start up from another drive 219

A

- AAUI Ethernet port 55, 58, 59, 76–77
- About This Macintosh (Apple menu) 142
- accent marks, typing 217–218
- access covers for expansion slots 76–77, 106–107
- access privileges for shared items 170, 172
- active program, identifying 36

- acute accent (´), typing 218
- adapters
 - Apple Ethernet AUI 55, 58–59
 - attenuated RCA 81
 - LocalTalk 53–54
- ADB cable 10
- ADB devices, connecting 91
- ADB ports 10–13, 76–77, 91
- Adobe Acrobat Reader program 21
- air circulation around computer components 7, 205
- America Online (AOL) service 67, 68
- amplified speakers 78, 80, 156
- analog telephone lines 46, 49
- Apple Assistance Center 130
- Apple-authorized dealers/service providers
 - adding SCSI or other devices 73, 84
 - CD-ROM drive service ix, 151
 - floppy disk drive service 158, 209
 - hard disk service 134, 176, 178, 180
 - installing expansion cards/memory 90, 95, 96
 - installing processor upgrade cards 95
 - interference with radio and television reception viii
 - keyboard or mouse service 163, 165, 206



Can't Find It?

See also **Macintosh Guide's onscreen index.**
Open the Guide (⌘) menu and choose Macintosh Guide; then click the Index button.

- obtaining peripheral devices and supplies viii, 55, 208
 - power supply service 210
 - removing extra built-in SCSI terminators 87
 - repair service and warranty questions 133
 - replacing the computer's clock
 - battery 166
 - "sad Macintosh" icon appears 138
 - AppleCD Audio Player 151, 156
 - Apple CD-ROM extension 150, 153
 - Apple Desktop Bus. *See* ADB
 - Apple Ethernet AUI Adapter 55, 58–59
 - Apple Ethernet Thin Coax Transceiver 55, 58
 - Apple Extras folder 21, 31, 39, 40
 - Apple Guide x, 18, 28
 - Apple Internet Connection Kit 67, 68
 - Apple LocalTalk Locking Connector Kit DIN-8 53, 54
 - Apple LocalTalk RJ-11 Connector 53, 54
 - Apple menu
 - About This Macintosh command 142
 - Apple System Profiler command 130–131
 - identifying 22
 - Apple Omni microphone 81
 - Apple PlainTalk Microphone 2, 81–83
 - AppleScript 39
 - AppleShare extension 170
 - Apple System Profiler utility 130–131
 - AppleTalk
 - configuring network connections 60–62
 - turning off/on for troubleshooting 163, 168, 169, 170, 172
 - AppleTalk control panel 60–62, 169, 171
 - Apple VideoPhone 40, 143
 - Application menu
 - Finder command 19, 29
 - Hide Others command 37
 - Show All command 37, 149
 - using 22, 36–37
 - application programs
 - allocating more memory to 142
 - compatibility problems 149
 - for debugging 166
 - included with the computer 41, 67–68
 - installing 34–35, 41, 185, 190
 - for online access 67–68
 - opening 36
 - quit unexpectedly 144–146
 - tips for using 38
 - troubleshooting 38, 142–149
 - working with more than one 36–37
 - arrow keys 215
 - arrow pointer on screen. *See* pointer
 - At Ease 140, 152
 - attenuated RCA adapter 81
 - audio CDs, troubleshooting 156
 - audio equipment, connecting to the computer 78–83
 - Audio In port on sound output devices 80
 - audio track on a CD-ROM disc, troubleshooting 156
- ## B
- backing up files 41
 - backup programs 41
 - Balloon Help 20–21, 30–31, 131
 - bar-code reader, adding to the computer 91
 - battery in computer's clock, replacing 166
 - blinking question mark icon 136, 181, 182
 - "bomb" message on screen 129, 144–146, 157
 - BootP server 63, 65
 - brightness control 17, 134

C

cables

- ADB 10
 - audio equipment 79
 - checking connections 134, 163, 164
 - coaxial 55, 57, 58
 - fiber-optic 58
 - keyboard 2, 11, 13, 163, 164
 - LocalTalk 53, 54
 - locking 92
 - modem 48
 - monitor 2, 9–10
 - mouse 11, 12, 163
 - safety instructions for 204, 205
 - SCSI peripheral interface 86
 - SCSI system 86
 - standard telephone 53
 - 10Base-T twisted-pair 55, 56
 - troubleshooting connections 16–17
 - when to unplug 101
- ### cache module
- configurations of 99
 - installing 111–123
 - removing 117
- ### cache module slot 97, 117, 118
- ### Caps Lock key 215
- ### carpal tunnel syndrome 200
- ### carrying the computer 3
- ### CD Extras folder 40
- ### CD player, connecting to the computer 78–80
- ### CD-ROM discs
- avoiding starting up from 140, 141, 152
 - cleaning 208
 - damaged 154
 - ejecting 35, 150, 151, 154, 209
 - handling 153, 154, 208–209
 - inserting 34, 181
 - ISO 9660– or High Sierra–format 155
 - saving changed information 154
 - starting up the computer from 138, 153, 180–181
 - troubleshooting 152, 153–157

CD-ROM drive

- illustration of 74–75
 - safety instructions for 208–209
 - troubleshooting 150–152
 - vibrations in 152, 155
- ### cedilla (ç), typing 218
- ### chains
- ADB 91
 - SCSI 84, 86, 87
- ### chair, adjusting for optimal support and comfort 201
- ### Chooser
- checking network settings 169
 - checking printer settings 168
 - doesn't list the computer you want to connect to 170
 - specifying the printer port 89
 - turning AppleTalk on/off 163, 169, 170
- ### circuit boards. *See* expansion cards
- ### circumflex (^), typing 218
- ### C key (at startup), to start up from a CD-ROM disc 219
- ### Claris Emailer Lite software 68
- ### cleaning equipment 208, 210–212
- ### clean installation of system software 186–190
- ### Clear key 215
- ### clock keeps time inaccurately 166
- ### close box 23
- ### closing
- the computer 121–123
 - the expansion card cover 110
 - a window 23
- ### coaxial cables 55, 57, 58
- ### color depth, performance and 163
- ### color display on a Photo CD, troubleshooting 157
- ### ColorSync 39
- ### communications regulation information viii–ix
- ### compatibility problems
- application programs 149
 - control panels 161
 - system extensions 161, 173–174



Can't Find It?

See also **Macintosh Guide's onscreen index.**
Open the **Guide (?)** menu and choose **Macintosh Guide**; then click the **Index** button.

- computer components. *See* equipment configurations
 - of DIMMs 97–99
 - switching among 62, 66
 - Configure pop-up menu 65
 - configuring
 - AppleTalk network connections 60–62
 - TCP/IP network connections 60, 63–66
 - connecting
 - ADB devices 91
 - audio equipment 78–83
 - to an Ethernet network 55–60
 - to a LocalTalk network 53–54, 60
 - a microphone 81–83
 - a modem 49
 - the monitor 7–10
 - the mouse and keyboard 11–13
 - to multiple networks
 - simultaneously 60
 - a printer 89
 - SCSI devices 84–88
 - a second monitor 90
 - to a telephone line 45–50
 - connectors
 - on the cache module 117, 118
 - on a DRAM DIMM 114, 115
 - on expansion cards 107–108
 - extended miniplug 79
 - safety instructions for 205
 - stereo miniplug 79, 80
 - on a VRAM DIMM 116
 - “Connect via” pop-up menu
 - AppleTalk control panel 61
 - TCP/IP control panel 64
 - contrast control 134
 - Control key 216
 - Control Panel Information command (Select menu of Apple System Profiler) 131
 - control panels
 - AppleTalk 60–62, 169, 171
 - compatibility problems 161
 - Easy Access 168
 - effects of resetting PRAM and NVRAM 135–136
 - Extensions Manager
 - CD-ROM drive problems 150, 153
 - file-sharing problems 172
 - floppy disk problems 159
 - locating problem extensions 174
 - printer problems 168
 - saving current extensions when rebuilding the desktop 194
 - typing produces nothing on screen 164, 165
 - File Sharing Monitor 170
 - General Controls 162
 - Keyboard 162
 - Memory 143, 149, 162
 - Monitors & Sound 83, 163, 166
 - Mouse 163
 - PC Exchange 148, 159
 - Sharing Setup 170, 171, 172
 - Startup Disk 161
 - TCP/IP 60, 64–66, 169
 - viewing options 131
 - Views 163
- Control Panels folder 153, 159
 - cover on the computer
 - removing 100–103
 - replacing 121–123
 - cumulative trauma disorders (CTDs) 200
 - Current Zone pop-up menu 62
 - customer support. *See also* Apple-authorized dealers/service providers
 - Apple Assistance Center 130
 - booklet described 127
 - hotline x, 18, 28
 - custom installation of system software 191–193
 - Custom Install dialog box 193

D

- damaged CD-ROM discs 154
- damaged floppy disks 158, 160
- damaged hard disks 175–178
- data-transfer speed
 - of ISDN lines 49
 - of modems 48
- debugging applications 166
- Delete key 216
- deleting locked files 148
- desktop
 - hiding and showing windows on 37
 - looks different when you start up, troubleshooting 140, 152
 - rebuilding 141, 194–195
- device drivers for SCSI equipment 88
- Device Information command (Select menu of Apple System Profiler) 131
- DHCP server 63, 65
- diacritical marks, typing 217–218
- diagnostic techniques. *See also* error messages; troubleshooting
 - checking system extension compatibility 173–174
 - initializing a hard disk 179–180
 - installing system software 182–193
 - rebuilding the desktop 194–195
 - starting up from the CD-ROM disc 180–181
 - testing and repairing a hard disk 175–178
- dialog boxes
 - Custom Install 193
 - Disk First Aid 177
 - Drive Setup 176, 180
 - Easy Install 185, 188, 189
 - Energy Saver 15
- digital telephone lines. *See* ISDN lines
- DIMMs
 - configurations of 97–99
 - installing 111–123
 - removing 114
- disconnecting the computer 6, 204
- discussion groups on the Internet 70
- disk cache 143, 162
- Disk First Aid dialog box 177
- Disk First Aid program 177–178, 183, 187, 191
- disk-formatting programs, file sharing and 171
- disk repair or recovery programs 176, 178
- disks. *See* CD-ROM discs; floppy disks; hard disk
- display. *See* monitors; screen
- displaying
 - information about your hardware and software 130–131
 - a partially hidden window 23
- documents. *See also* files in DOS/Windows format, working with 148, 159
 - problems opening 147–148, 154
- downloading
 - files from the Internet 70
 - Web pages, modem speed and 48
- DRAM
 - configuration specifications 98
 - installing 111–123
 - removing a DRAM DIMM 114
- DRAM slots 97, 114, 115
- Drive Setup dialog box 176, 180
- Drive Setup program
 - initializing a hard disk 179–180
 - installing system software 184, 187, 192
 - testing a hard disk for damage 176
- Dual Inline Memory Modules. *See* DIMMs
- dynamic random-access memory. *See* DRAM



Can't Find It?
See also Macintosh
Guide's onscreen index.
Open the Guide (⌘)
menu and choose
Macintosh Guide; then
click the Index button.

E

- Easy Access control panel 164, 168
- easy installation of system software 183–186
- Easy Install dialog box 185, 188, 189
- Eject Disk command (Special menu) 150, 151
- ejecting
 - CD-ROM discs 35, 150, 151, 209
 - floppy disks 35, 158, 209
- ejectors
 - on a DRAM slot 114, 115
 - on a VRAM slot 116
- electromagnetic emissions from monitors 203
- electrostatic discharge 101
- e-mail, features of 69
- emergency ejection hole
 - on the CD-ROM drive 151
 - on the floppy disk drive 158, 209
- Empty Trash command (Special menu) 24, 148
- Energy Saver dialog box 15
- Enter key 216
- equipment
 - arranging to prevent discomfort 201–202
 - cleaning 208, 210–212
 - displaying information about 130–131
 - guidelines for handling 205–210
 - illustration of 2, 74–75
- error messages. *See also* diagnostic techniques; troubleshooting
 - “a file can’t be found” 149
 - “application has unexpectedly quit” 144–146
 - “application program can’t be found” 147
 - “a system error has occurred” 144
 - with blinking icons in the menu bar 167
 - blinking question mark 136, 181, 182
 - “bomb” message 129, 144–146, 157
 - disk with an X 137
 - font file problems 167
 - ID numbers for 128
 - “not enough memory” 142
 - printing problems 169
 - requesting to insert a disk after you’ve ejected it 150, 160
 - responding to 128
 - right-angle bracket (>) 166
 - “sad Macintosh” 138
 - “This disk is damaged: Do you want to initialize it?” 159
 - “This is not a Macintosh disk: Do you want to initialize it?” 153, 159
- Escape key 216
- Ethernet media adapters 55, 58–59
- Ethernet networks, connecting to 55–60
- Ethernet ports 55, 58, 59, 76–77
- Ethernet transceivers 55, 58–59
- expansion bay 74–75
- expansion card cover
 - closing 110
 - opening 105
- expansion cards
 - alternative networks and 51
 - installing 95–96, 100–110, 121–123
 - for a second monitor 90
- expansion slots
 - access covers for 76–77, 106–107
 - expansion cards supported by 96
 - installing a video card 90
- extended miniplug 79
- Extension Information command (Select menu in Apple System Profiler) 131
- extensions. *See* system extensions
- Extensions folder 170
- Extensions Manager control panel. *See also* system extensions
 - CD-ROM drive problems 150, 153
 - file-sharing problems 172

- floppy disk problems 159
- locating problem extensions 174
- printer problems 168
- saving current extensions when rebuilding the desktop 194
- typing produces nothing on screen 164, 165
- external SCSI terminators 87
- eye fatigue from computer use 199, 201, 203

F

- fatigue from computer use 199, 201, 203
- feet on keyboard, lowering 12
- Fiber Distributed Data Interface (FDDI) networks 51
- fiber-optic cable 58
- file compression programs 167
- File menu
 - Get Info command 142, 148, 169
 - Open command 36
 - Put Away command 35, 150, 151, 160, 209
 - Quit command 150, 160
- files. *See also* documents
 - accessing ISO 9660- and High Sierra-format files 155
 - backing up 41
 - deleting 148
 - downloading from the Internet 70
 - on Photo CDs, troubleshooting 157
- file sharing
 - hard disk space requirements for 170, 171
 - troubleshooting 148, 169-172
- File Sharing folder 171
- File Sharing Monitor control panel 170
- Finder 19, 29, 39
- floppy disk drive 74-75, 158, 209
- floppy disks
 - for backup purposes 41
 - damaged 158, 160
 - ejecting 35, 138, 158, 160, 209

- formatting on a DOS computer for use in a Macintosh 159
- initializing 159
- inserting 34
- safety instructions for 207
- troubleshooting 158-160, 209
- unlocking 148, 158

- folders
 - Apple Extras 21, 31, 39, 40
 - CD Extras 40
 - Control Panels 153, 159
 - Extensions 170
 - File Sharing 171
 - Preferences 135, 171
 - Previous System Folder 189, 190
 - System Folder 38, 131, 139, 147, 186-190
- folder sizes calculation, performance and 163
- font files, damaged 167
- Foreign File Access extension 153, 155
- forums on the Internet 70
- Function keys 216
- furniture, arranging to prevent discomfort 201-202

G

- General Controls control panel 162
- GeoPort. *See* modem port; printer port
- Get Info command (File menu) 142, 148, 169
- graphics tablet, adding to the computer 91
- grave accent (`), typing 218
- grounding the computer 6, 205
- Guide menu. *See also* Macintosh Guide
 - displaying 20-21, 26-27, 30-31
 - identifying 25
- Guide window, moving or shrinking 19, 29



Can't Find It?

See also Macintosh

Guide's onscreen index.

Open the Guide (⌘?)

menu and choose

Macintosh Guide; then

click the Index button.

H

handling equipment, guidelines 205–210

hard disk

illustration of 74–75

initializing 179–180

testing and repairing 175–178

troubleshooting 140, 161

updating 184, 187, 192

hard disk space required for file sharing
170, 171

hardware handshaking protocol 48

headphones 78, 80, 156

health-related information about
computer use 199–203

help. *See also* Apple-authorized
dealers/service providers;
Balloon Help; customer support;
error messages; Macintosh
Guide; troubleshooting

via the Internet 20, 30

where to find answers to questions x,
18, 28

Hide Balloons command (Guide menu)
20, 30

Hide Others command (Application
menu) 37

High Sierra-format files 155

“Huh?” button, Guide window 19, 29

icons

ADB port 9, 11, 12, 91

appear different from usual 167

Apple menu 22

Application menu 22

application program 24

blinking in the menu bar 167, 168

blinking question mark 136, 181, 182

defined 24

Disk First Aid 177, 183, 187, 191

disk with an X 137

Display Preferences 135

document 24

Drive Setup 176, 179, 184, 187, 192

Ethernet 55

folder 24

Guide menu 21, 22, 25, 31

hard disk 24

Installer 40

Install System Software 184, 188, 192

modem port 48

printer port 53, 89

Read Me 21, 24, 31

“sad Macintosh” 138

SCSI 84

sound input/output ports 78

System Folder 24

Trash 24

ID numbers

for error messages 128

for SCSI devices 84, 85, 140, 175

image files on Photo CDs,
troubleshooting 157

Index button, Macintosh Guide 19,
21, 29

initializing

a floppy disk 159

a hard disk 179–180

inserting

CD-ROM discs 34, 181

floppy disks 34

insertion point, setting 164

Installer program 184–185, 188–189,
192–193

installing

application programs 34–35, 41,
185, 190

file-sharing and network software 172

memory 95, 97–99, 111–123

a PCI expansion card 95–96,
100–110, 121–123

printer drivers 168–169

the security bar 92–93

system extensions 185, 190

system software 182–193

Integrated Services Digital Network. *See*
ISDN

interference
from electrical equipment 168
with radio and television reception
viii, 90, 206
between two monitors 90
internal SCSI interface 84
international symbols and characters,
typing 217–218

Internet
connecting to and using 67–70
getting help via 20, 30

Internet service provider (ISP) 68

IP address 63, 65

ISDN lines
connecting to 50
data-transfer speed of 49
overview 46
usage fees 50

ISDN networks 51

ISDN terminal adapters 50

ISO 9660–format files 155

J

joystick, adding to the computer 91

K

keyboard. *See also* Power key
checking connections 163, 164
connecting 11–13
illustration of 2, 74
lowering the feet on 12
positioning 12, 13, 202
repeat rate adjustments 162
safety instructions for 206
special keys on 215–216
troubleshooting 163–165
keyboard cable 2, 11, 13, 163, 164
Keyboard control panel 162
keyboard tray 202
Key Caps program 217–218

L

lifting the computer 3
line splitters, modems and 49
liquid spills on the equipment 204, 205,
206, 208, 209
LocalTalk adapter and cable 53–54
LocalTalk networks, connecting to
53–54, 60
locked files 148
locking cables 92
locking/unlocking the mouse 213–214
logic board, locations of memory slots
on 97
long-distance charges, modems and 47
Look For button, Macintosh Guide 19,
21, 29

M

Macintosh Easy Open 194
Macintosh Guide (onscreen help)
overview x, xi, 18, 28
for troubleshooting help 130
using 19, 21, 29
Macintosh Tutorial (onscreen training)
20–21, 25–27, 30–31
MacIP server 64, 65
Mac OS. *See* system software
Mac OS Guide. *See* Macintosh Guide
memory
AppleTalk and 62, 66
cache module configuration
specifications 99
changing allocation of 142
DRAM configuration
specifications 98
installing 95, 97–99, 111–123
performance and 162
printing and 169
RAM disk 143, 162
troubleshooting 142–143, 144, 146,
149, 157



Can't Find It?

See also **Macintosh Guide's onscreen index.**

Open the **Guide (G)**

menu and choose

Macintosh Guide; then

click the **Index button.**

- used by system software additions 40
 - virtual memory 38, 143, 162
 - VRAM configuration
 - specifications 99
 - Memory control panel 143, 149, 162
 - memory interleaving 98
 - memory slots 97, 112, 114–118
 - menu bar
 - blinking icons in, troubleshooting 167, 168
 - defined 22
 - menu blinking, performance and 162
 - menus, opening 22
 - microphone 2, 81–83, 166
 - modem cables 48
 - modem port 76–77
 - modems 46–49
 - moisture or wetness, computer exposure to 204, 205, 209
 - monitor cable 2, 9–10
 - monitor port 9, 76–77
 - monitor power cord, connecting 7–8
 - monitor power socket 8, 76
 - monitors. *See also* screen
 - brightness control 17, 134
 - cleaning 210
 - connecting 7–10, 90
 - contrast control 134
 - electromagnetic emissions from 203
 - illustration of 2, 74–75
 - maximum weight on top of the computer 3, 7
 - positioning 7, 202
 - safety instructions for 206
 - supported by the computer 7
 - turning on 14
 - Monitors & Sound control panel 83, 163, 166
 - mouse
 - checking connections 163
 - cleaning 211–212
 - connecting 11–13
 - illustration of 2, 74
 - learning to use 26–27
 - locking/unlocking 213–214
 - proper positioning of 202
 - troubleshooting 163
 - mouse button 26
 - mouse cable 11, 12
 - Mouse control panel 163
 - Mouse Keys feature 164
 - mouse tracking speed, performance and 163
 - moving
 - the computer 3
 - the Guide window 19, 29
 - multiple networks, connecting to 60
 - musculoskeletal discomfort from computer use 199, 200, 203
- ## N
- “native” programs 38, 149
 - navigation buttons, Guide window 19, 29
 - Netscape Navigator Web browser 68
 - network administrator
 - choosing a network zone 62
 - configuring your connection 65
 - connecting to a network 53, 55, 57
 - obtaining access privileges for shared items 170, 172
 - unlocking the AppleTalk control panel 61, 64
 - Network extension 170
 - networks
 - alternate types of 51
 - backing up files on 41
 - configuring connections 60–66
 - connecting to 53–60
 - installing application programs from 35
 - ISDN terminal adapters and 50
 - shared telecommunications equipment for online access 46
 - troubleshooting 169–172

- network zones
 - choosing 62, 65
 - defined 61
- nonvolatile video RAM. *See* NVRAM
- normal installation of system software 183–186
- NuBus cards 96
- numeric keys 216
- NVRAM, resetting 135–136, 161, 171

O

- office furniture, arranging to prevent discomfort 201–202
- online access
 - application programs for 67–68
 - equipment needed for 45–50
- onscreen help. *See* Balloon help; Macintosh Guide
- onscreen training, Macintosh Tutorial 20–21, 25–27, 30–31
- Open/Close button on CD-ROM drive 74–75
- OpenDoc software 40, 68
- Open command (File menu) 36
- opening
 - application programs 36
 - the CD-ROM tray 151
 - the computer 100–104
 - documents, troubleshooting 147–148, 154
 - the expansion card cover 105
- open programs, identifying 36
- operating system software.
See system software
- optional system software 40, 143
- Option key 216, 217–218, 219

P

- parameter RAM. *See* PRAM
- PC Exchange control panel 39, 148, 159
- PCI expansion cards. *See* expansion cards
- pdf icons or file names 21
- performance of computer,
troubleshooting 161–163
- peripheral component interconnect expansion cards. *See* expansion cards
- phone company messaging services 47
- phone jacks, modems and 49
- Photo CDs, troubleshooting 157
- PlainTalk 40, 143
- plugging in the computer and monitor 4–6, 8
- pointer 26, 141, 163, 164
- port access covers 76–77, 106–107
- ports
 - AAUI Ethernet 55, 58, 59, 76–77
 - ADB 10–13, 76–77, 91
 - Audio In (on sound output devices) 80
 - modem 76–77
 - monitor 9, 76–77
 - printer 53–54, 76–77, 89
 - SCSI 76–77, 84
 - security lock 76–77, 92
 - sound input/output 76–77, 78, 79, 80, 81
 - specifying in the AppleTalk control panel 61–62
 - specifying in the TCP/IP control panel 63, 64
 - 10Base-T Ethernet 55, 56, 76–77
- power button 16, 17, 74–75, 129
- power cords
 - checking connections 134
 - connecting 6, 7–8
 - disconnecting 6, 111, 204
 - frayed 204
 - illustration of 2, 6



Can't Find It?

See also **Macintosh Guide's onscreen index**.
Open the Guide (🔍) menu and choose **Macintosh Guide**; then click the **Index** button.

Power key

- illustration of 14, 74–75, 216
 - restarting the computer 129, 216, 219
 - starting the computer 14, 216
 - turning off the computer 32, 216
 - waking the computer 17
- power-on light
- on the computer 16, 74–75
 - on the monitor 17
- power sockets on back of computer 76
- power supply 104, 210
- power switch on the monitor 14
- power usage limitations
- of ADB devices 91
 - of expansion cards 96
- PRAM, resetting 135–136, 161, 171
- Preferences folder 135, 171
- Previous System Folder 189, 190
- printer drivers 89, 168–169
- printer port 53–54, 76–77, 89
- printers
- connecting 89
 - troubleshooting 136, 168–169
- problems. *See* Apple-authorized dealers/service providers; customer support; error messages; troubleshooting
- processor upgrade cards 95
- programs. *See* application programs
- Put Away command (File menu) 35, 150, 151, 160, 209

Q

- question mark
- blinking, icon for system software problems 136, 181, 182
 - icon for the Guide menu 21, 25, 26
- QuickDraw GX or 3D 40
- QuickTime (part of system software) 39, 157
- Quit command (File menu) 150, 160

R

- radio and television reception, interference with viii, 90, 206
- RAM. *See* memory
- RAM disk 143, 162
- RARP server 63, 65
- RCA-type connectors 79
- Read Me documents 21, 31, 40, 41
- rebuilding the desktop 141, 194–195
- reinstalling. *See* installing
- release buttons on the computer 102
- release switches on the top chassis 112, 120
- removable storage devices, file sharing and 171
- removing
- the cache module 117
 - the computer cover 100–103
 - DIMMs 114
 - extra built-in SCSI terminators 87
 - the security bar 93, 101
- repairing a damaged disk 175–178
- repetitive stress injuries (RSIs) 200
- replacing
- the computer clock battery 166
 - the computer cover 121–123
- restarting the computer 129, 219
- troubleshooting 141, 152
- Restart command (Special menu) 129, 181
- Return key 216
- RJ-45 telephone-style connector 56
- router address 65
- RS232 cables 86

S

- safety instructions
 - cleaning equipment 210–212
 - connecting devices 88, 91
 - discharging static electricity 104
 - general precautions 204–205
 - grounding the computer 6, 205
 - handling CD-ROM discs and floppy disks 153–154, 207–209
 - handling the keyboard and monitor 206
 - installing expansion cards and memory 95, 96
 - lifting or carrying the computer 3
 - liquid spills on equipment 204, 205, 206, 208, 209
 - locking/unlocking the mouse 213–214
 - servicing the power supply 210
 - setting the voltage switch 4, 6, 100
 - turning on the computer 123
 - using the CD-ROM drive ix, 151, 208–209
- saving
 - changed information on a CD-ROM disc 154
 - current set of system extensions 194–195
 - documents, before restarting the computer 129
- screen. *See also* monitors
 - appears dark 134
 - minimizing glare and reflections 202, 203
 - positioning 7, 202
- screen saver programs 134
- scroll arrows 23
- SCSI chains 84, 86, 87
- SCSI devices 84–88, 136
- SCSI IDs. *See* ID numbers
- SCSI interface, internal 84
- SCSI peripheral interface cable 86
- SCSI port 76–77, 84
- SCSI system cable 86
- SCSI terminators 87
- securing the computer. *See* security bar
- security bar 2, 92–93, 101, 122
- security lock ports 76–77, 92
- service and support. *See* Apple-authorized dealers/service providers; customer support
- Sets pop-up menu 194, 195
- setting up the computer equipment 1–17
- shared disks, troubleshooting 170, 172
- shared folders, deleting files from 148
- shared libraries 149
- Sharing Setup control panel 170, 171, 172
- Shift key 216
- Shift key (at startup), to turn off system extensions 219
- Shift key combinations, Key Caps program and 217
- Show All command (Application menu) 37, 149
- Show Balloons command (Guide menu) 20–21, 30–31, 131
- shrinking the Guide window 19, 29
- Shut Down command (Special menu) 32, 100, 140, 152. *See also* turning off the computer
- SIMMs 98, 99
- Single Inline Memory Modules. *See* SIMMs
- size box 23
- sleep state 17, 134
- Slow Keys feature 164
- Small Computer System Interface. *See* SCSI
- software
 - included with the computer 39–41
 - included with modems 49
- sound, problems recording from an audio CD 156
- sound input/output devices, connecting 78–80, 82–83



Can't Find It?

See also **Macintosh Guide's onscreen index**.
Open the Guide (⌘) menu and choose Macintosh Guide; then click the Index button.

- sound input/output ports 76–77, 78, 79, 80, 81
 - Sound Input pop-up menu 83
 - Spacebar (at startup), to start the Extensions Manager 219
 - speaker 74. *See also* amplified speakers
 - Special menu
 - Eject Disk command 150, 151
 - Empty Trash command 24, 148
 - Restart command 129, 181
 - Shut Down command 32, 100, 140, 152
 - speed
 - of computer, troubleshooting 161–163
 - of ISDN lines 49
 - of modems 48
 - starting up the computer
 - from the CD-ROM disc 138, 153, 180–181, 219
 - troubleshooting 16–17, 134–141, 161
 - turning it on 14–16
 - startup disk, troubleshooting 137, 161, 175
 - Startup Disk control panel 161
 - static electricity, discharging 104
 - stereo miniplug 79, 80
 - stereo sound, recording or playing 78–80
 - Sticky Keys feature 164
 - subnet mask number 63, 65
 - sunlight, computer exposure to 205
 - support arm on the bottom chassis 113, 119
 - support foot on the computer 111, 120
 - switching to another application program 37
 - symbols and international characters, typing 217–218
 - system extensions. *See also* Extensions Manager control panel
 - Apple CD-ROM 150, 153
 - AppleShare 170
 - checking for compatibility 161, 173–174
 - Foreign File Access 153, 155
 - installing application programs and 34
 - Network 170
 - reinstalling 185, 190
 - saving current set of 194–195
 - troubleshooting 139, 173–174
 - turning off/on 135–136, 165, 173–174, 194–195
 - viewing options 131
 - System Folder
 - avoiding more than one 38, 131
 - creating a new one 186–190
 - files contained in 147
 - troubleshooting 139
 - System Folder Information command (Select menu in Apple System Profiler) 131
 - System Overview command (Select menu in Apple System Profiler) 130
 - system software
 - described 39
 - installing 182–193
 - optional 40, 143
 - troubleshooting 136–138
- T**
- Tab key 216
 - tape deck, connecting to the computer 78–80
 - TCP/IP control panel 60, 64–66, 169
 - TCP/IP network connections, configuring 60, 63–66
 - Technical Information* booklet
 - connecting ADB devices 91
 - connecting additional equipment 73
 - expansion card power requirements 96
 - external SCSI interface 84
 - memory upgrades 99
 - monitor support 7
 - telephone cables 53

- telephone line, connecting the computer to 45–50
- television and radio reception, interference with viii, 90, 206
- temperature limits for floppy disks 207
- 10Base-T Ethernet port 55, 56, 76–77
- 10Base-T hub 56
- 10Base-T twisted-pair cable 55, 56
- terminators for SCSI chains 87
- testing and repairing a hard disk 175–178
- thick coaxial cable 55, 58
- thin coaxial cable 57, 58
- thin coaxial Ethernet network, connecting to 57–58
- thin coaxial transceiver 55, 57, 58
- three-wire grounding plug 6, 205
- tilde (~), typing 218
- title bar 23
- Token Ring networks 51
- Topics button, Macintosh Guide 19, 21, 29
- training, Macintosh Tutorial 20–21, 25–27, 30–31
- transceivers, Ethernet 55, 58–59
- Transmission Control Protocol/Internet Protocol. *See* TCP/IP
- Trash
 - deleting locked files in 148
 - emptying 24
- troubleshooting. *See also* diagnostic techniques; error messages
 - Apple System Profiler and 130–131
 - application program malfunctions 38, 142–149
 - audio CDs don't play correctly 156
 - blinking icons in menu bar 167, 168
 - blinking question mark 136, 181, 182
 - “bomb” message on screen 129, 144–146, 157
 - cable connections 16, 17
 - CD-ROM disc/drive problems 150–157
 - clock keeps time inaccurately 166
 - computer freezes 138–139, 141, 144, 157
 - computer makes unusual sounds 134–136, 168
 - computer won't restart 141
 - deleting files 148
 - desktop looks different when you start up 140, 152
 - displaying system information 130–131
 - documents, working with 147–148
 - equipment connections 138–139
 - file sharing problems 148, 169–172
 - flashing empty box appears at startup 141
 - floppy disk/drive problems 137, 158–160, 209
 - font files, damaged 167
 - hard disk problems 140, 161, 175–178
 - icons appear different from usual 167
 - icons do not appear at startup 141
 - interference with radio and television reception viii, 90, 206
 - ISO 9660– or High Sierra–format files 155
 - keyboard problems 163–165
 - Macintosh Guide and 130
 - memory problems 142–146, 149, 157
 - microphone malfunctions 166
 - mouse problems 163
 - network usage problems 169–172
 - performance and speed decrease 161–163
 - Photo CD problems 157
 - pointer alternates between an arrow and wristwatch 141
 - pointer doesn't move 163
 - PRAM and NVRAM problems 135–136
 - printer problems 136, 168–169
 - rebuilding the desktop 141
 - restarting the computer 129, 141
 - right-angle bracket (>) on screen 166



Can't Find It?

See also **Macintosh Guide's onscreen index**.
Open the **Guide (G)** menu and choose **Macintosh Guide**; then click the **Index** button.

- “sad Macintosh” icon 138
 - screen is dark 134
 - SCSI device connections 136
 - shared disk problems 170, 172
 - starting up the computer 16–17, 134–141, 161
 - startup disk problems 137, 161, 175
 - system extension compatibility 139, 173–174
 - system software problems 136–138, 186
 - typing produces nothing on screen 164–165
 - a window has disappeared 149
 - turning off
 - AppleTalk 62, 163, 168
 - the computer
 - to attach or remove devices 80, 81, 88, 91
 - to connect cables 16, 17
 - general instructions for 32
 - to install an expansion card or memory 100
 - for troubleshooting purposes 140, 151, 152
 - system extensions 135, 165, 173, 194–195
 - turning on
 - AppleTalk 168, 169, 170, 172
 - the computer 14–16
 - troubleshooting 16–17, 134–141, 161
 - external SCSI devices 88
 - system extensions 136, 174
 - tutorial 20–21, 25–27, 30–31
 - twisted-pair Ethernet network, connecting to 55, 56
 - twisted-pair patch cord 56
 - typing
 - international characters and symbols 217–218
 - nothing appears on screen, troubleshooting 164–165
- ## U
- umlaut (¨), typing 218
 - unlocking floppy disks 148, 158
 - unlocking/locking the mouse 213–214
 - unplugging
 - cables 101
 - the computer 6, 204
 - updating the hard disk 184, 187, 192
 - upgrading system software 182
 - Usenet newsgroups 70
 - User Mode command (AppleTalk control panel) 62, 66
 - Users & Groups data file 171
- ## V
- VCR, connecting to the computer 78–80
 - ventilation around computer components 7, 205
 - ventilation openings on the computer and monitors 90, 206
 - video card 90
 - video conferencing software 40, 143
 - video random-access memory. *See* VRAM
 - Views control panel 163
 - virtual memory 38, 143, 162
 - virus protection programs 34
 - voltages for different locations 5
 - voltage switch 4, 6, 8, 100
 - Volume Information command (Select menu in Apple System Profiler) 131
 - VRAM
 - configurations of 99
 - installing 111–123
 - VRAM slots 97, 116

W, X, Y

- waking the computer 17, 134
- warranty on the computer 95, 133
- Web pages. *See* World Wide Web
- wetness or moisture, computer exposure to 204, 205, 209
- windows
 - hiding and showing 37, 149
 - working with 23
- Windows/DOS documents or disks,
 - working with 148, 159
- work space, arranging to prevent discomfort 201–202
- World Wide Web
 - accessing 69
 - getting help from 20, 30
 - modem speed and 48

Z

- zones. *See* network zones
- zoom box 23
- zooming the Guide window 19, 29



Power Macintosh
User's Manual



Includes setup, troubleshooting, and important health-related information for Power Macintosh 7300 series computers

 Apple Computer, Inc.

© 1997 Apple Computer, Inc. All rights reserved.

Under the copyright laws, this manual may not be copied, in whole or in part, without the written consent of Apple. Your rights to the software are governed by the accompanying software license agreement.

The Apple logo is a trademark of Apple Computer, Inc., registered in the U.S. and other countries. Use of the “keyboard” Apple logo (Option-Shift-K) for commercial purposes without the prior written consent of Apple may constitute trademark infringement and unfair competition in violation of federal and state laws.

Every effort has been made to ensure that the information in this manual is accurate. Apple is not responsible for printing or clerical errors.

Apple Computer, Inc.
1 Infinite Loop
Cupertino, CA 95014-2084
408-996-1010
<http://www.apple.com>

Apple, the Apple logo, AppleScript, AppleTalk, AppleVision, Chicago, ColorSync, EtherTalk, GeoPort, HyperCard, LaserWriter, LocalTalk, Mac, Macintosh, PlainTalk, PowerBook, Power Macintosh, QuickTime, and StyleWriter are trademarks of Apple Computer, Inc., registered in the U.S. and other countries.

AppleCD, At Ease, Balloon Help, Disk First Aid, Extensions Manager, Finder, Foreign File Access, and QuickDraw are trademarks of Apple Computer, Inc.

Adobe, Acrobat, and PostScript are trademarks of Adobe Systems Incorporated or its subsidiaries and may be registered in certain jurisdictions.

Claris is a registered trademark and Claris EMailer is a trademark of Claris Corporation.

Helvetica and Times are registered trademarks of Linotype-Hell AG and/or its subsidiaries.

Netscape Navigator is a trademark of Netscape Communications Corporation.

NuBus is a trademark of Texas Instruments.

PowerPC and the PowerPC logo are trademarks of International Business Machines Corporation, used under license therefrom.

Simultaneously published in the United States and Canada.

Mention of third-party products is for informational purposes only and constitutes neither an endorsement nor a recommendation. Apple assumes no responsibility with regard to the performance or use of these products.



Contents



Communications regulation information viii

Preface **Why Is This Book So Thin?** **xi**

Part I **Getting Started**

1 **Setting Up Your Computer** **1**

Positioning the computer 3

Plugging in the computer 4

Connecting a monitor 7

Connecting the mouse and keyboard 11

Turning the computer on 14

Problems turning your computer on? 16

What's next? 17

Where to find answers 18

Four simple tips for using Macintosh Guide effectively 19

Reviewing the basics 22

2	Learning to Use Your Computer	25
	Learning the basics	26
	After you take the tutorial	27
	Where to find answers	28
	Four simple tips for using Macintosh Guide effectively	29
	Turning the computer off	32
3	Installing and Using Software	33
	Installing application programs	34
	Opening an application program	36
	Working with several programs at a time	36
	Five tips for using application programs effectively	38
	About the software included with your computer	39
	Backing up your files	41

Part II Communicating With Other Computers

4	Connecting Your Computer to a Telephone Line	45
	Types of equipment	46
	Choosing and connecting a modem	47
	Connecting to an ISDN line	49
5	Connecting Your Computer to a Network	51
	Connecting to a LocalTalk network	53
	Connecting to an Ethernet network	55
	Configuring your network connection	60
6	Using an Online Service or the Internet	67
	Connection software	67
	What you can do online	69

Part III Expanding Your Computer's Capabilities

7 Connecting Additional Equipment 73

Your computer's components and front panel controls 74

Your computer's ports and connectors 76

Connecting audio equipment 78

Connecting external SCSI devices 84

Connecting a printer 89

Connecting a second monitor 90

Connecting an ADB input device 91

Securing your computer 92

8 Installing PCI Expansion Cards and Additional Memory 95

About PCI expansion cards 96

About memory 97

Installing a PCI expansion card or memory 100

Part IV Troubleshooting

9 Start Here If Trouble Occurs 127

Step 1: Gather as much information as you can 128

Step 2: Restart your computer 129

Step 3: Check onscreen help, if you can 130

Step 4: Check the next chapter, "Solutions to Common Problems" 130

Step 5: Use Apple System Profiler 130

10	Solutions to Common Problems	133
	Problems turning on or starting up your computer	134
	Problems with application programs, documents, and memory	142
	Problems with CD-ROM drives and discs	150
	Problems with floppy disks and floppy disk drives	158
	Problems with hard disks	161
	Problems with your computer's speed	161
	Other problems with your computer	163
	Problems with your printer	168
	Problems with networks and file sharing	169
11	Diagnostic Techniques	173
	Checking your system extensions	173
	Testing and repairing your hard disk	175
	Starting up from the system software CD-ROM disc	180
	Installing system software	182
	Rebuilding your desktop	194

Part V **Appendixes**

Appendix A Health, Safety, and Maintenance Tips 199

Health-related information about computer use 199

Safety instructions 204

Handling your computer equipment 205

Cleaning your equipment 210

Locking and unlocking the mouse 213

Appendix B Special Keys on Your Keyboard 215

Typing special characters and symbols 217

Special key combinations 219

Index 221

Communications regulation information

FCC declaration of conformity

This device complies with part 15 of the FCC rules. Operation is subject to the following two conditions: (1) This device may not cause harmful interference, and (2) this device must accept any interference received, including interference that may cause undesired operation. See instructions if interference to radio or television reception is suspected.

Radio and television interference

The equipment described in this manual generates, uses, and can radiate radio-frequency energy. If it is not installed and used properly—that is, in strict accordance with Apple’s instructions—it may cause interference with radio and television reception.

This equipment has been tested and found to comply with the limits for a Class B digital device in accordance with the specifications in Part 15 of FCC rules. These specifications are designed to provide reasonable protection against such interference in a residential installation. However, there is no guarantee that interference will not occur in a particular installation.

You can determine whether your computer system is causing interference by turning it off. If the interference stops, it was probably caused by the computer or one of the peripheral devices.

If your computer system does cause interference to radio or television reception, try to correct the interference by using one or more of the following measures:

- Turn the television or radio antenna until the interference stops.
- Move the computer to one side or the other of the television or radio.
- Move the computer farther away from the television or radio.
- Plug the computer into an outlet that is on a different circuit from the television or radio. (That is, make certain the computer and the television or radio are on circuits controlled by different circuit breakers or fuses.)

If necessary, consult an Apple-authorized service provider or Apple. See the service and support information that came with your Apple product. Or, consult an experienced radio/television technician for additional suggestions.

IMPORTANT Changes or modifications to this product not authorized by Apple Computer, Inc., could void the FCC Certification and negate your authority to operate the product.

This product was tested for FCC compliance under conditions that included the use of Apple peripheral devices and Apple shielded cables and connectors between system components. It is important that you use Apple peripheral devices and shielded cables and connectors between system components to reduce the possibility of causing interference to radios, television sets, and other electronic devices. You can obtain Apple peripheral devices and the proper shielded cables and connectors through an Apple-authorized dealer. For non-Apple peripheral devices, contact the manufacturer or dealer for assistance.

Responsible party: Robert Steinfeld, Apple Computer, Inc., 1 Infinite Loop, Cupertino, CA 95014-2084, 408-974-2618.



Industry Canada statement

This Class B device meets all requirements of the Canadian Interference-Causing equipment regulations.

Cet appareil numérique de la Class B respecte toutes les exigences du Règlement sur le matériel brouilleur du Canada.

VCCI Class 2 statement

情報処理装置等電波障害自主規制について

この装置は、情報処理装置等電波障害自主規制協議会（VCCI）の基準に基づく第二種情報技術装置です。この装置は、家庭環境で使用することを目的としていますが、この装置がラジオやテレビジョン受信機に近接して使用されると、受信障害を引き起こすことがあります。

取扱説明書に従って正しい取り扱いをしてください。

CD-ROM drive

WARNING Making adjustments or performing procedures other than those specified in your equipment's manual may result in hazardous exposure.

WARNING Do not attempt to disassemble the cabinet containing the laser. The laser beam used in this product is harmful to the eyes. The use of optical instruments, such as magnifying lenses, with this product increases the potential hazard to your eyes. For your safety, have this equipment serviced only by an Apple-authorized service provider.

If you have an internal Apple CD-ROM drive in your computer, your computer is a Class 1 laser product. The Class 1 label, located in a user-accessible area, indicates that the drive meets minimum safety requirements. A service warning label is located in a service-accessible area. The labels on your product may differ slightly from the ones shown here.

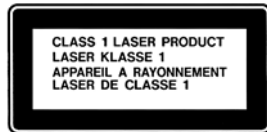

Class 1 label

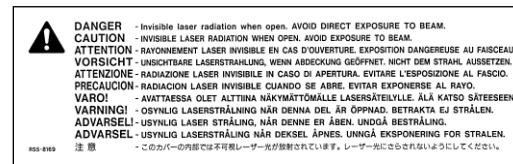

Service warning label

Where to find answers

When you have questions about using your Macintosh, there are several places you can look for answers.



Apple Guide

If you need help or experience a problem while using the computer, open the Guide (⌘) menu and choose Macintosh Guide (or Mac OS Guide). The Guide menu is the main source for information while you are using the computer.

Macintosh User's Manual

Use this book to help you set up your computer and learn about it, or to find solutions to problems.

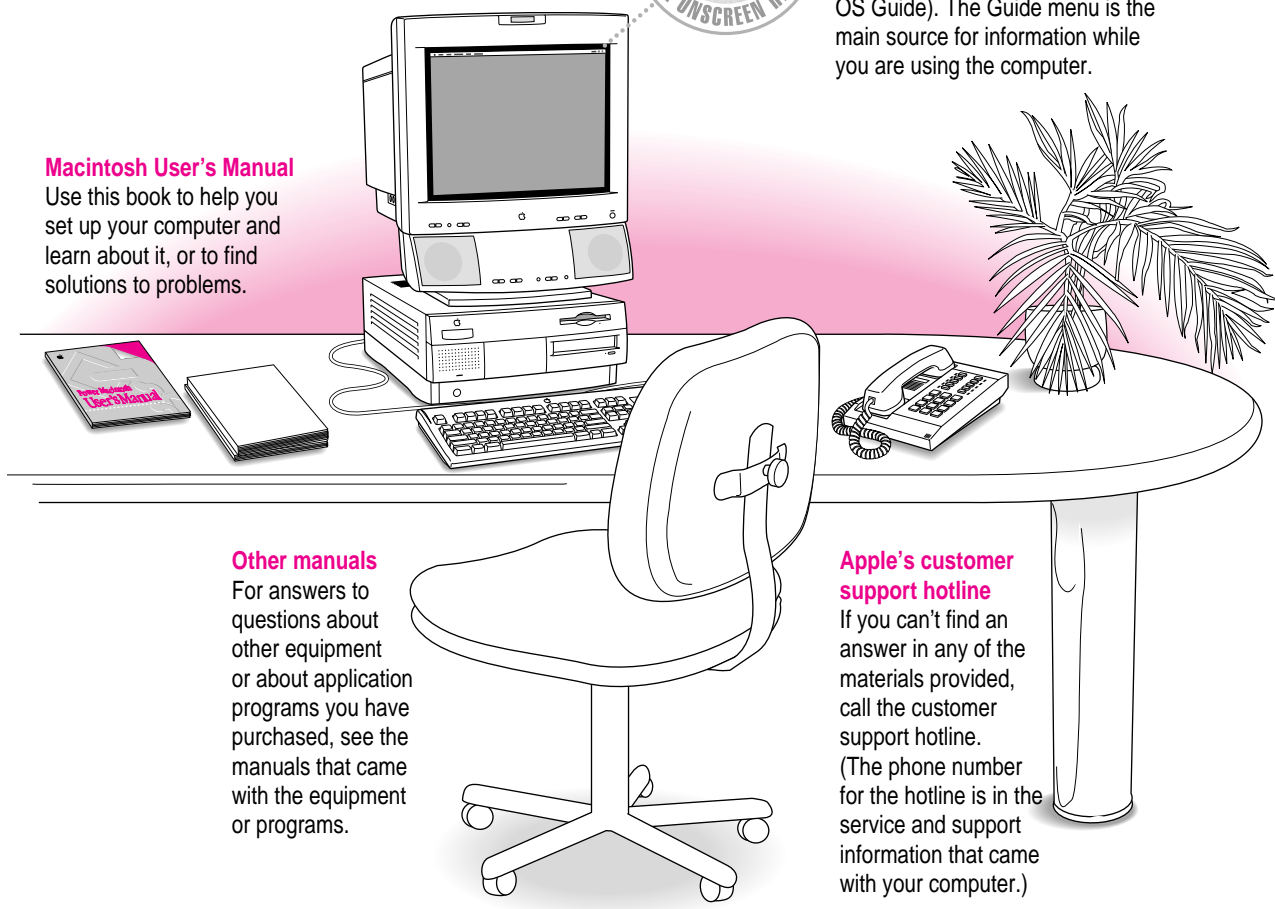

Other manuals

For answers to questions about other equipment or about application programs you have purchased, see the manuals that came with the equipment or programs.

Apple's customer support hotline

If you can't find an answer in any of the materials provided, call the customer support hotline. (The phone number for the hotline is in the service and support information that came with your computer.)



Why Is This Book So Thin?



You've just purchased a powerful computer with virtually limitless capabilities. So why isn't the manual the size of the New York City phone directory?

One reason is that the Macintosh is easier to use than other computers.

Another reason is that the instructions for how to use your system software are included in a comprehensive onscreen help system—Macintosh Guide. Macintosh Guide (also called Mac OS Guide on some systems) helps you in ways that a manual can't. It gives you more ways to search for information. It's "smart" enough to give you instructions catered to your situation. It can even circle things on the screen for you.

Once you've set up your computer be sure to try Macintosh Guide. You'll find it under the little yellow question mark at the upper-right of your screen.

Getting Started

Chapter 1 Setting Up Your Computer

Chapter 2 Learning to Use Your Computer

Chapter 3 Installing and Using Software



part

