



Power Macintosh G3  
All-In-One

---





## Basics

Power Macintosh G3  
All-In-One





movie.studio

## Overview

Introducing the Power Macintosh G3 All-In-One design.

- The new all-in-one is designed for education and fulfills all the computing needs of teachers and students.
- Powerful and easy-to-use video editing and multimedia authoring features at an affordable price.

Click the icon at left for a QuickTime VR movie of the Power Mac G3 All-In-One.



**Features of the Power Macintosh G3 All-In-One include**

- PowerPC G3 microprocessor running at 233 MHz or 266 MHz
- RAM expandable to 384 MB in 3 DIMM slots using 64-bit wide, 168-pin JEDEC-standard 3.3 V unbuffered SDRAM DIMMs
- 512K of static RAM used as L2 cache on processor module
- Built-in 2D and 3D hardware graphics acceleration
- PERCH slot to support I/O card
- One modem slot on the I/O card for optional fax/modem card
- 4 GB or 6 GB ATA hard drive
- 100 MB SCSI Iomega Zip drive
- CD-ROM ATAPI drive at 24X speed
- 1.4 MB SuperDrive
- One SCSI port
- Two GeoPort serial ports
- 10BASE-T Ethernet port





- One ADB port
- Three PCI expansion slots to accept
  - three 7-inch PCI cards, or
  - three 15 W cards, or
  - two 25 W cards, or
  - one 15 W card and one 25 W card
- Fan speed thermally controlled
- Energy Saver control panel
- 2 MB video RAM expandable to 6 MB with 3.3 V, 100 MHz or faster SGRAM on a 144-pin small outline dual inline memory module (SO-DIMM)





**Optional Build-to-Order Power Mac All-In-One Features:**

- 100 MB SCSI Iomega Zip drive in the expansion bay
- 6 GB hard drive
- 64 MB (using one 64 MB DIMM) or 96 MB (using 1x 32 MB and 1x64 MB DIMM) of memory
- I/O, Audio/Video card
- 10/100 BaseT ethernet card





## The Cuda Chip

The Cuda is a microcontroller chip. Its function is to

- Turn system power on and off
- Manage system resets from various commands
- Maintain parameter RAM (PRAM)
- Manage the Apple Desktop Bus (ADB)
- Manage the real-time clock

Many system problems can be resolved by resetting the Cuda chip (see Symptom Charts for examples). Press the Cuda reset button on the logic board to reset the Cuda chip. (See “Logic Board Diagram” later in this chapter to locate the Cuda reset button.) If you continue to experience system problems, refer to “Resetting the Logic Board” in this Basics chapter.





## Resetting the Logic Board

Resetting the logic board can resolve many system problems (refer to “Symptom Charts” for examples). Whenever you have a unit that fails to power up, you should follow this procedure before replacing any modules.

- 1 Unplug the computer.
- 2 Remove the battery from the logic board.
- 3 Disconnect the power supply cable from the logic board and then press the Power On button. (See “Logic Board Diagram” later in this chapter to locate the Power On button.)
- 4 Wait at least 10 minutes before replacing the battery.
- 5 Make sure the battery is installed in the correct +/- direction.







6 Reassemble the computer and test the unit.

**Note:** This procedure resets the computer's PRAM. Be sure to check the computer's time/date and other system parameter settings afterwards.





## Sound

The sound system for the Power Macintosh G3 computers is implemented entirely on the I/O card. Each supports 16-bit stereo sound output and input, available simultaneously.

The sound circuitry on the I/O card and system software can create sounds digitally and either play the sounds through speakers inside the enclosure or send the sound signals out through the sound output jacks. The sound circuitry digitizes and records sound as 16-bit samples. The computer can use 22.05K or 44.100K samples per second. The sound system plays samples at the sampling rate specified in the Monitors & Sound control panel.





The Power Macintosh G3 also records sound from several sources:

- A microphone connected to the line-level sound input jack
- A compact disc in the CD-ROM player
- Analog sound from the cross-platform card in a PCI slot
- Analog sound from optional communication cards
- Internal Microphone

With each sound input source, sound playthrough can be enabled or disabled.





## Sound Output

All sound output features for the Power Macintosh G3 computer are provided by the I/O card. The I/O card provides one mini jack for sound output on the back of the enclosure.

The output jacks are connected to the sound amplifier. The mini jack is intended for connecting a pair of headphones or amplified external speakers. There are two speakers and two headphone jacks on the front of the system. Inserting a plug into the sound output mini jack disconnects the internal speaker.





## Sound Input

The I/O card provides a stereo sound input jack on the back of the enclosure for connecting an external Apple PlainTalk line-level microphone or other sound source pair of line-level signals. The sound input jack accepts a standard 1/8-inch stereophonic phone plug (two signals plus ground).

**Note:** The microphone for the Macintosh LC and LC II does not work with the I/O cards.

Options in the Monitors & Sound control panel determine the interaction between the sound input and output devices. The sound circuitry normally operates in one of three modes:

- Sound playback—computer-generated sound is sent to the speaker and the sound output jacks.
- Sound playback with playthrough—computer sound and sound input are mixed and sent to the speakers and sound output jacks.





- Sound record with playthrough—input sound is recorded and also sent to the speakers and sound output jacks.





## PowerPC G3 and Backside Cache

Backside cache is a significant architectural design change from earlier PowerPC processors. The main advantage of the backside cache architecture is the speed of the dedicated CPU-to-L2 cache interface. Using the dedicated bus allows the CPU to access the fast L2 cache storage through a high speed bus without addressing the slower system bus or competing with other devices attached to the system bus. In comparison, a “far-side” cache running on the system bus would limit that SRAM interface to 50MHz.

The PowerPC G3 microprocessor interfaces with SRAM storage via a dedicated bus running at various multiples of the core PLL CPU speed. With high speed L2 SRAM and a dedicated L2 bus, the CPU can access stored information up to the speed of the processor clock. L2 access is determined by the clock ratio setting. For example, with a 250MHz





PowerPC G3, and a 2.5 L2 bus ratio, the backside cache bus speed will be 100MHz, twice the speed of the system bus.

## SDRAM DIMMs

Three DRAM expansion slots on the logic board accept 3.3 V SDRAM unbuffered 8-byte DIMMs. The 168-pin DIMM has a 64-bit-wide data bus per bank. The minimum bank size supported on the Power Macintosh G3 all-in-one model is 4 MB, and the largest is 64 MB. The largest DIMM supported is a two-bank DIMM of 64 MB using 32 Mbit SDRAM devices.

The Power Macintosh G3 All-In-One logic board supports a maximum DRAM expansion of 384 MB. Fill all three slots with 128 MB DIMMs.







The DRAM DIMMs can be installed one or more at a time. The logic board supports only linear memory organization. Therefore, no performance gains are seen when two DIMMs of the same size are installed. Any supported size DIMM can be installed in any DIMM slot, and the combined memory of all the DIMMs installed will be configured as a contiguous array of memory.

**Important:** Power Macintosh G3 computers use SDRAM DIMMs. DIMMs from older Macintosh computers are not compatible and should not be used even though they fit into the DRAM DIMM slots.





## SGRAM Video Memory

The Power Macintosh G3 logic board comes with 2 MB of Synchronous Graphic RAM (SGRAM) video memory soldered on. The logic board also contains a video memory expansion slot that accepts a Small Outline DIMM (SO-DIMM) to increase video memory up to a maximum of 6 MB. Apple supports a 4 MB SGRAM SO-DIMM that is 32-bit wide, 144-pin, fast-paged, 100 MHz/10 ns cycle time or faster.

**Important:** Use only SGRAM SO-DIMMs. Never use the 256K or 512K video memory DIMMs used in older Macintosh computers.





# DIMM Slots

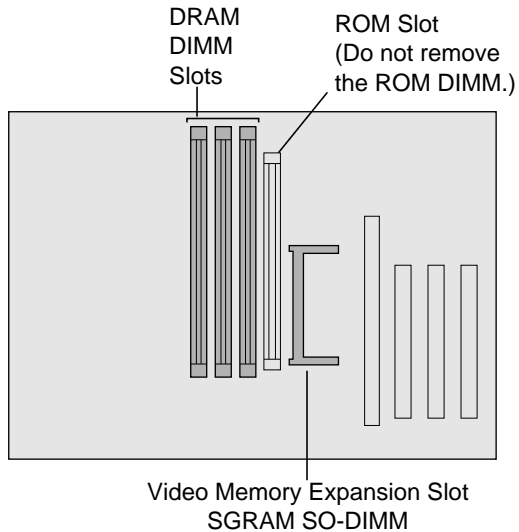



## Peripheral Component Interconnect (PCI)

The Peripheral component Interconnect (PCI) expansion slots accept 7-inch PCI cards. Install only expansion cards that come with Macintosh drivers and are compliant with the PCI 2.1 standard. Nubus™ cards cannot be used in these expansion slots.

PCI offers significantly higher performance than the NuBus architecture used in previous Macintosh models. Running at 33 MHz, the PCI bus is up to three times faster than NuBus, offering overall enhanced system performance, particularly in the areas of video and networking.





# Internal Locator

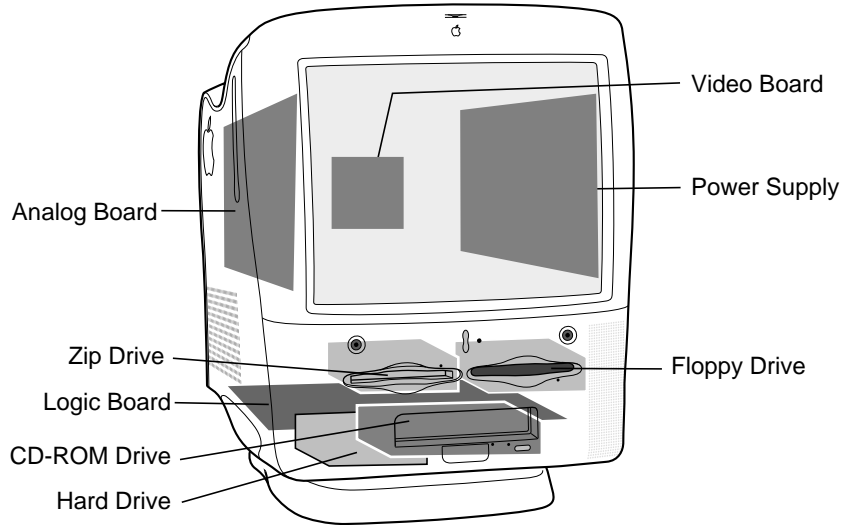



# Rear View

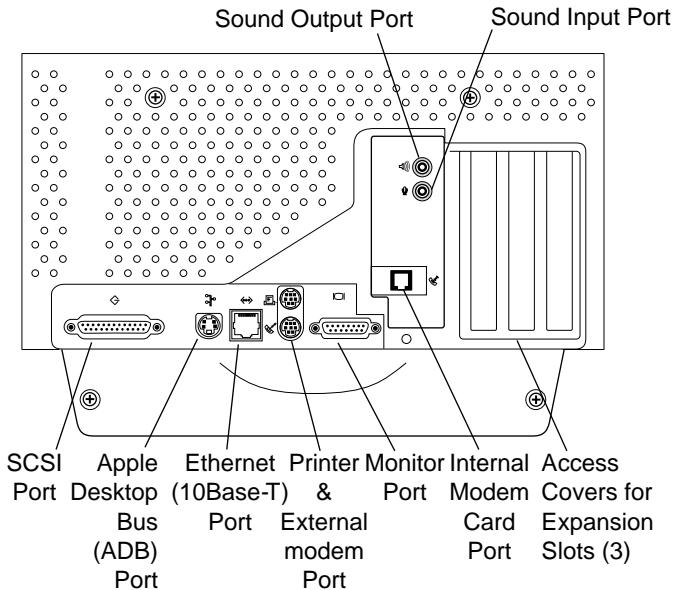

See next page for optional AV card.





# Optional AV Card

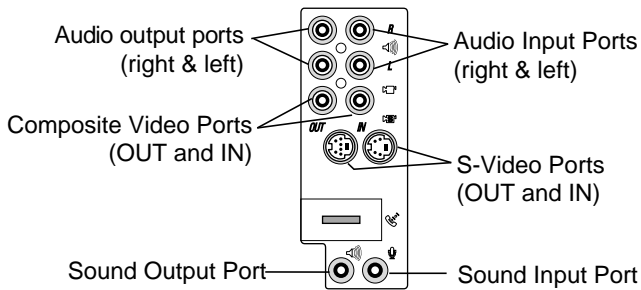

Optional AV ports





# Logic Board

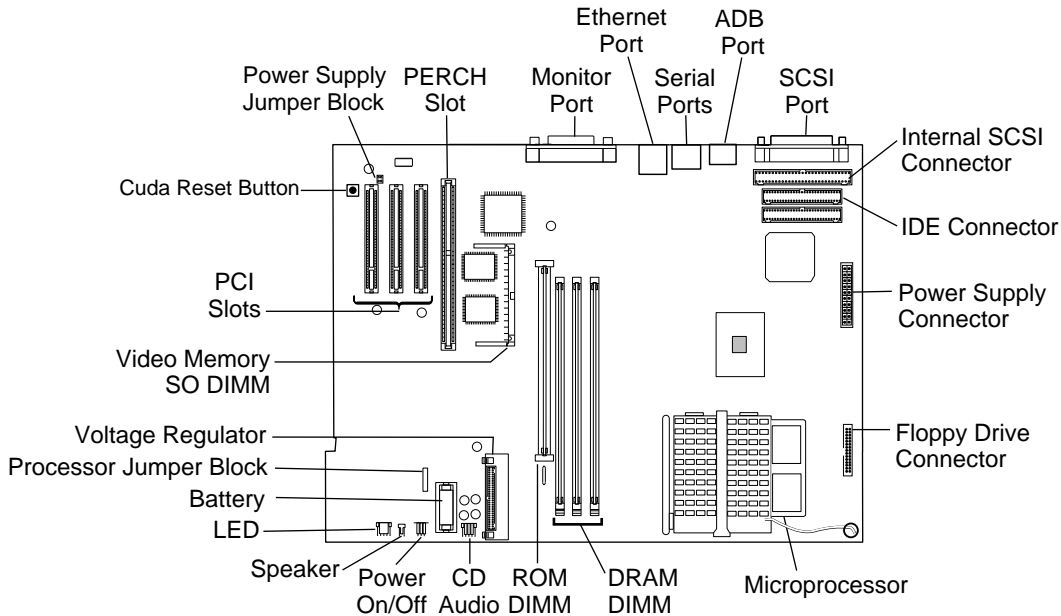





## Repair Strategy

Service the Power Macintosh G3 computers through module exchange and parts replacement. Customers can request on-site service from an Apple Authorized Service Provider Plus (AASP+), Apple Assurance (US only), or Apple Canada Technical Answerline (Canada only). They can also choose carry-in service from an AASP.

### Ordering

Apple Service Providers planning to support the computer systems covered in this manual may purchase Service modules and parts to develop servicing capability. To order parts, use the AppleOrder (US only) or ARIS (Canada only) system and refer to the Power Macintosh G3 “Service Price Pages.”





Large businesses, universities, and K-12 accounts must provide a purchase order on all transactions, including orders placed through the AppleOrder (US only) or ARIS (Canada only) system.

### **USA Ordering**

US Service providers not enrolled in AppleOrder may fax their orders to Service Provider Support (512-908-8125) or mail them to

Apple Computer, Inc.  
Service Provider Support  
MS 212-SPS  
Austin, TX 78714-9125

For US inquiries, please call Service Provider Support at 800-919-2775 and select option #1.





## Canadian Ordering

Canadian Service providers not enrolled in ARIS may fax their orders to Service Provider Support in Canada (1-800-903-5284). For Canadian inquiries, please call Service Provider Support at 905-513-5782 and select option #3.





# Warranty/AppleCare/ARIS

## **US Only**

The Power Macintosh G3 computers are covered under the Apple One-Year Limited Warranty. The AppleCare Service Plan is also available for these products. Service Providers are reimbursed for warranty and AppleCare repairs made to these computers. For pricing information, refer to “Service Price Pages.”

## **Canada Only**

The Power Macintosh G3 computers are covered under AppleCare. The Extended AppleCare Service Plan is also available for these products. Service Providers are reimbursed for warranty and AppleCare repairs made to these computers. For pricing information, refer to “Service Price Pages.”





## Specifications

---

Power Macintosh G3 All-in-One





# Introduction

Specifications information for this product can be found in this chapter and also in the Spec Database, which you can access in one of three ways:

- Launch it directly by double-clicking the Apple Spec Database runtime alias at the top level of the Main Service Source CD.
- Select "Apple Spec Database" from the Service Source drop-down main menu.
- Click the Acrobat toolbar icon for the database, which is near the right end of the toolbar with the letters "SP."





## Processor

### **CPU**

PowerPC G3 RISC microprocessor running at 233 or 266 MHz  
Built-in FPU  
Requires system software version 8.1 or later with appropriate  
Enabler version

### **Processor Bus**

64-bit wide, 66 MHz, supporting split address and data tenures





# Memory

## **SDRAM**

32 MB standard, expandable to 384 MB

Uses 168-pin, 64-bit, 10 ns, 100 MHz unbuffered synchronous dynamic access memory (SDRAM) DIMMs (1K, 2K, or 4K refresh rate)

## **Cache**

512K of static RAM used as Level 2 cache integrated into the processor module

## **ROM**

4 MB ROM on 160-pin DIMM, 64-bit ROM data bus width

## **Video RAM**

2 MB expandable to 4 MB or 6 MB using 32-bit wide, 144-pin, 3.3 V, fast-paged SGRAM SO-DIMM connector with 10 ns RAM access time or faster







## I/O Interfaces

### **SCSI Port**

External SCSI connector is 25-pin D-type connector. Supports up to seven SCSI devices.

### **Serial Port**

Two serial ports support AppleTalk and GeoPort serial protocols. Accept 8-pin or 9-pin plugs.

### **ADB Port**

One Apple Desktop Bus port for a keyboard, mouse, etc.

### **Ethernet Port**

10Base-T, RJ-45



**Expansion**

Three internal expansion slots, supporting 7-inch PCI expansion cards, compatible with all PCI 2.1 specification-compliant cards with the addition of Mac OS-specific software driver (not NuBus compatible)

Accepts three PCI cards, or two 25-watt cards, or one 15-watt card and one 25-watt card.

One internal expansion bay that accepts a 3.5" or 5.25" storage device that is up to 1.625" (41.3 mm) high. Some models come with a Zip drive already installed in one of the bays.





## I/O Devices

### **Keyboard**

AppleDesign Keyboard

### **Mouse**

ADB Mouse II

### **Microphone**

Apple internal microphone standard





## Disk Storage

**Hard Drive**

2 GB or 4 GB internal ATA hard drive  
6 GB internal on build-to-order systems

**Floppy Drive**

One Apple SuperDrive 1.4 MB floppy drive

**CD-ROM Drive**

One internal 24x ATAPI CD-ROM drive

**Zip Drive**

Optional 100 MB SCSI Iomega Zip drive





## Video

### **Video Display Modes**

Built-in monitor port supports:

- 640 x 480, 800 x 600, 832 x 624 at 32 bits per pixel
- 1024 x 768 at 16 bits per pixel

### **Graphics acceleration**

Built-in graphics controller, 2D and 3D hardware graphics acceleration of QuickDraw graphics





## I/O Cards

### PERCH Slot

The PERCH slot connector is a 182-pin microchannel connector that supports the Apple I/O cards.

**Note:** The PERCH slot does **not** accept PCI cards.

### Sound

Rear jack for stereophonic speakers

Supports 16 bits/channel stereo input and output

External 1/8" jack for sound in

Sample rates of 22.05, or 44.1 kHz

### Modem Slot

112-pin connector to accept optional fax/modem card

**Note:** Does **not** carry PCI signals





## Electrical

<b>Line Voltage</b>	90–264 V AC, rms, single phase
<b>Frequency</b>	50–60 Hz
<b>Maximum Power</b>	300 W maximum continuous 200 W peak output





# Physical

## Dimensions

<b>Height:</b>	19.92 in. (498 mm)
<b>Width:</b>	16.08 in. (402 mm)
<b>Depth:</b>	18.00 in. (450 mm)
<b>Weight:</b>	59.5 lb. (27 kg); weight varies depending on devices installed







## Environmental

**Operating  
Temperature**

50 to 104° F (10 to 40° C)

**Storage  
Temperature**

-40 to 116° F (-40 to 47° C)

**Relative Humidity**

5-95% noncondensing

**Maximum Altitude**

10,000 ft. (3,048 m)





Take Apart

---

Power Macintosh G3

All-In-One





## Chassis Carrier

No preliminary steps are required before you begin this procedure.

- 1 Loosen the four screws.
- 2 Pull the chassis carrier half way out of the unit.

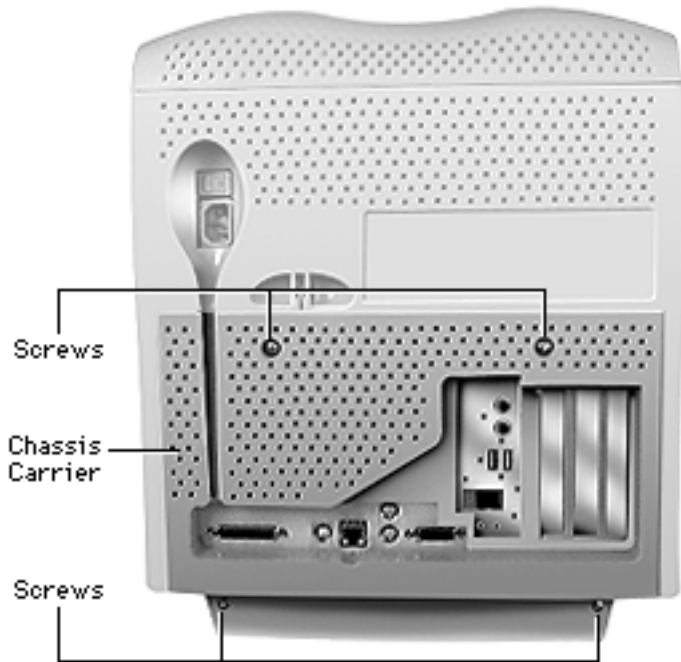

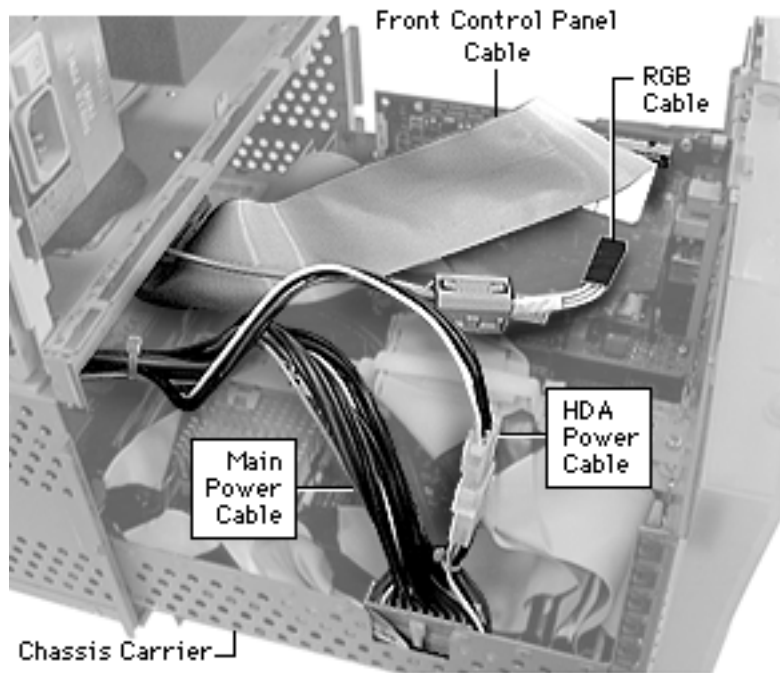

- 3 Disconnect the front control panel cable, RGB cable, main power cable, and HDA power cable.



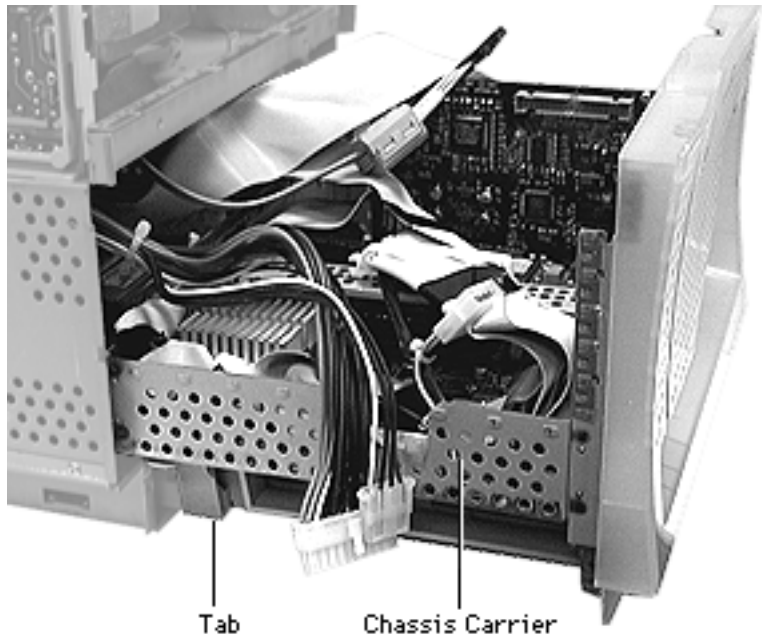

- 4 Press up on the tabs to release the chassis carrier.
- 5 Pull chassis carrier out of unit.

**Note:** See graphic on next page showing complete chassis carrier out of the unit.



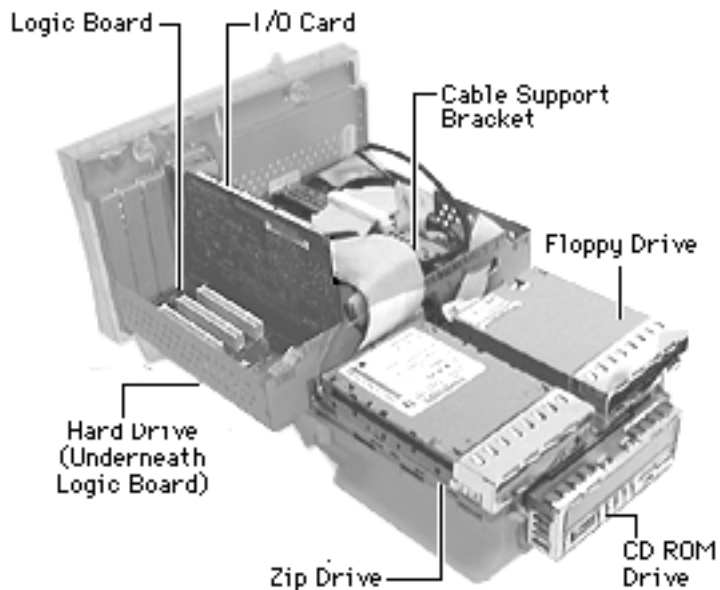

**Note:** Graphic illustrates modules and support bracket located in chassis carrier.





## Hard Drive

Before you begin, remove the chassis carrier.

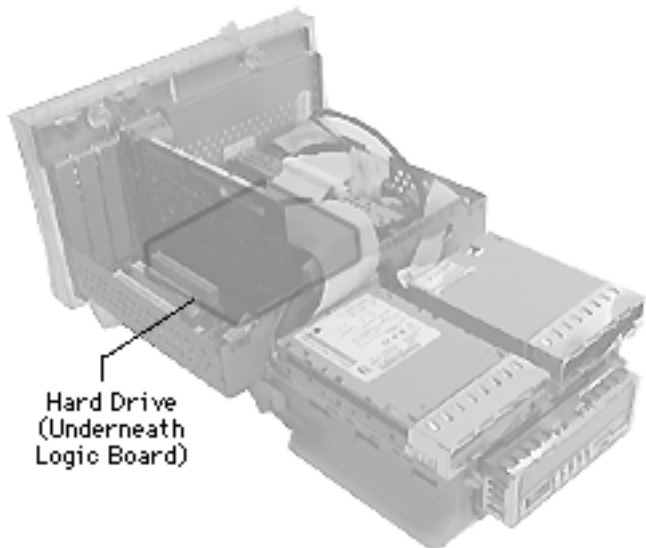

Hard Drive  
(Underneath  
Logic Board)





- 1 Disconnect the SCSI cable and the power cable from the back of the hard drive.

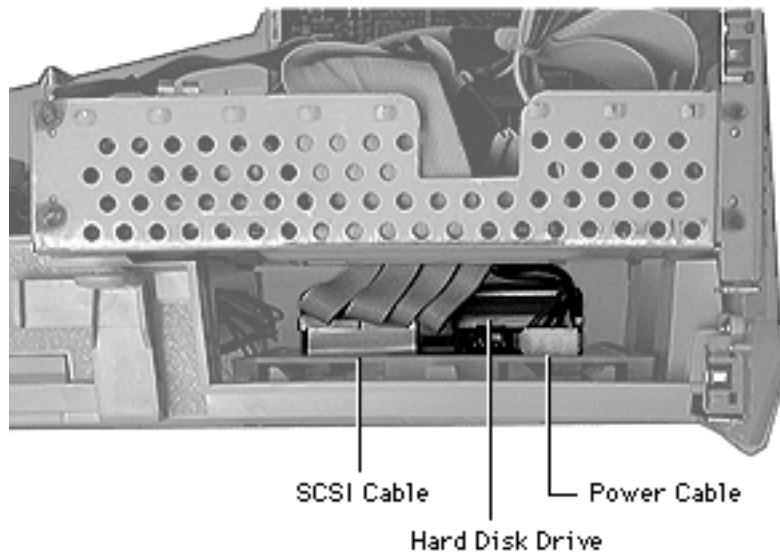



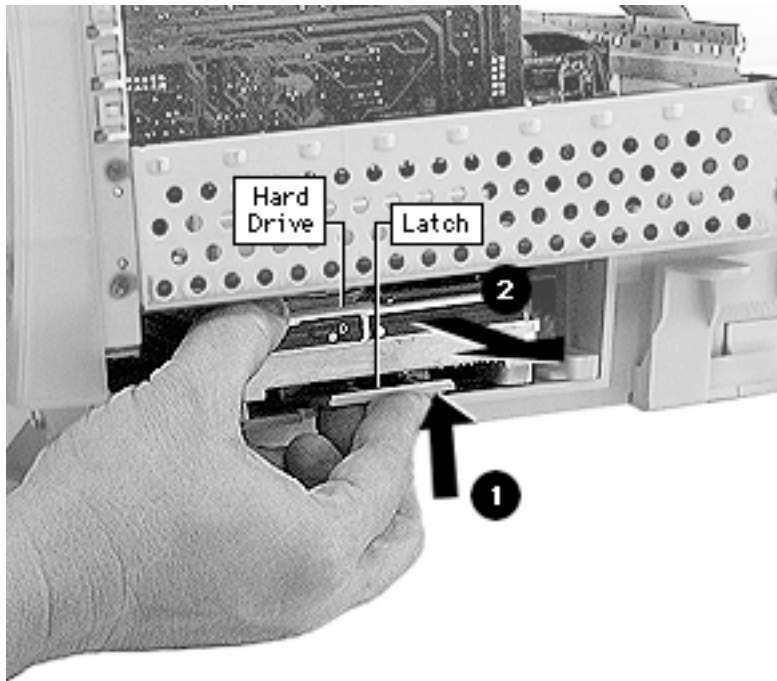

- 2 Pull up the release latch and slide the hard drive forward to remove it from the internal chassis.

**Note:** Be sure to remove the hard drive from its carrier before returning the drive to Apple.





## Floppy Drive

Before you begin, remove the chassis carrier.

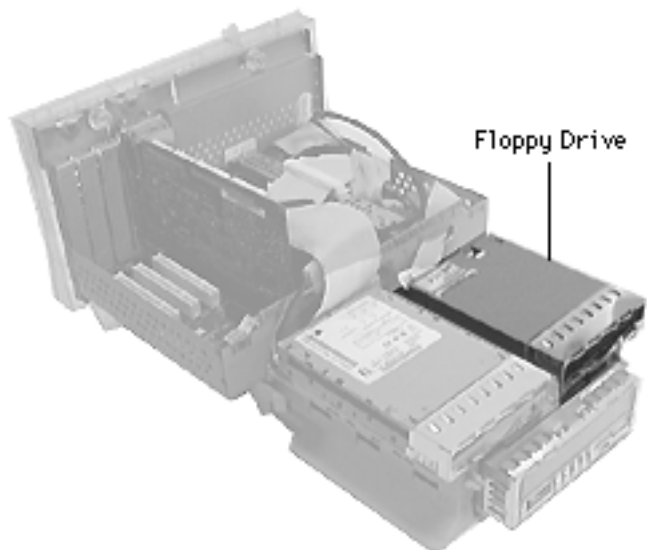

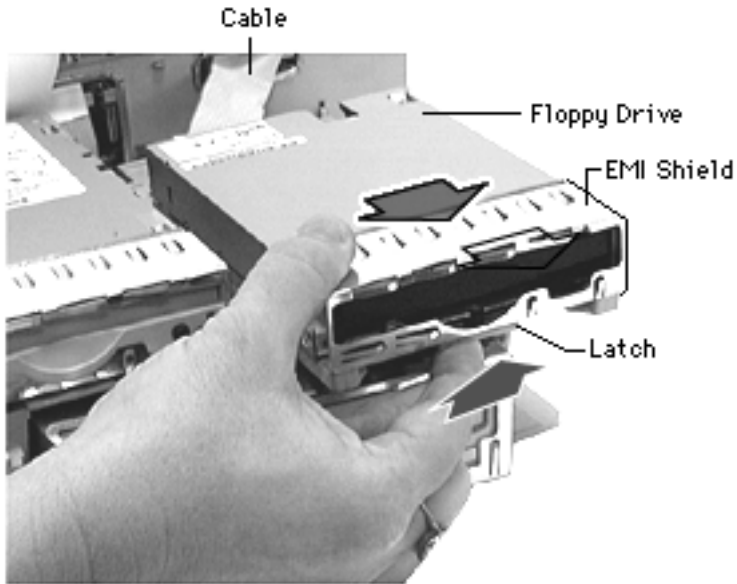

- 1 Pull up the release latch, and slide the floppy drive forward enough to reach the floppy cable.
- 2 Disconnect the cable from the back of the floppy drive.
- 3 Remove the floppy drive from the unit.

**Note:** Be sure to remove the EMI shield and floppy drive carrier before returning the drive to Apple.





## Zip Drive

Before you begin, remove the chassis carrier.

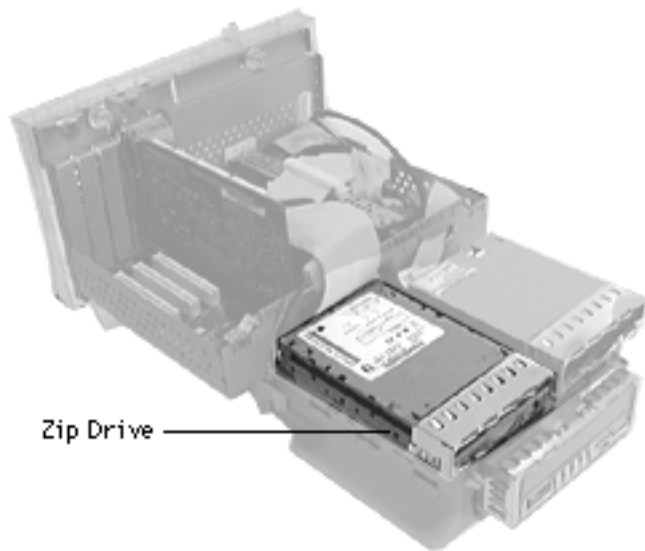

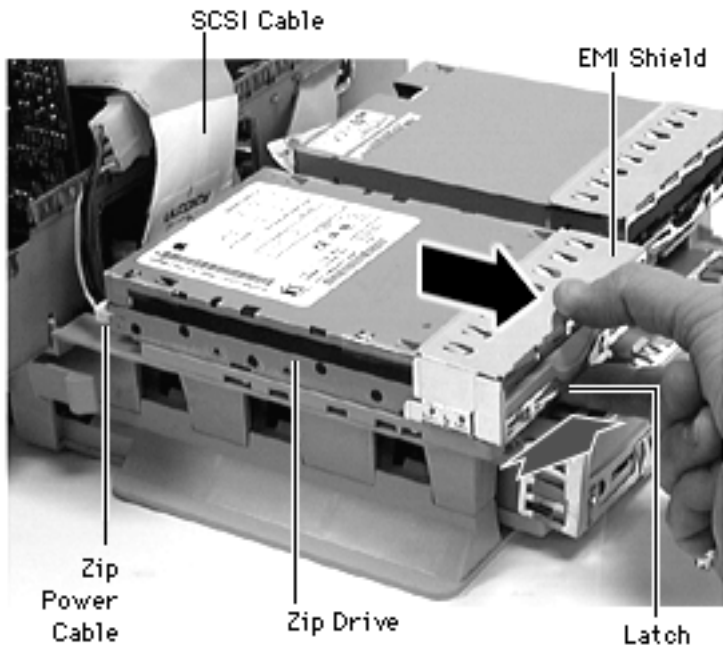

- 1 Pull up the release latch, and slide the Zip drive forward enough to reach the cables.
- 2 Disconnect the SCSI and Zip power cables from the back of the Zip drive.
- 3 Remove the Zip drive from the unit.

**Note:** Be sure to remove the EMI shield and Zip drive carrier before returning the drive to Apple.





## Adding a Zip Drive

There may be requests to add a zip drive to a Power Mac G3 All-in-one computer. Some prebuilt and build-to-order configurations do not include a zip drive. Therefore, customers may want to upgrade their systems by installing a zip drive taken from another computer, or by purchasing the individual service parts.

See the Additional Procedures section for instructions.





## CD-ROM

Before you begin, remove the chassis carrier.

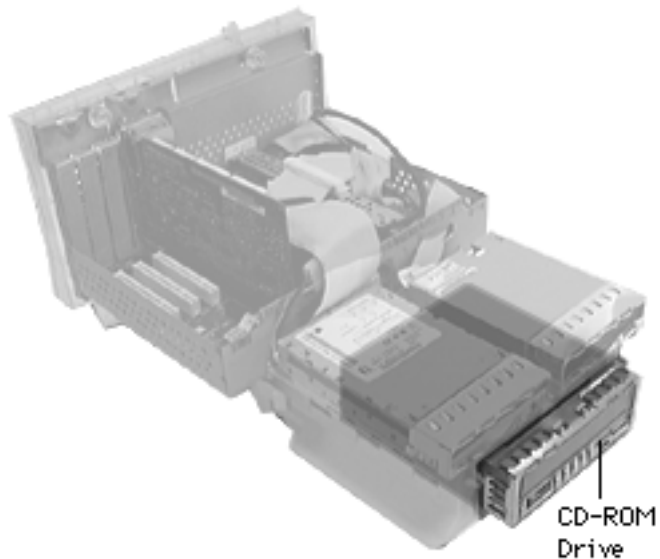

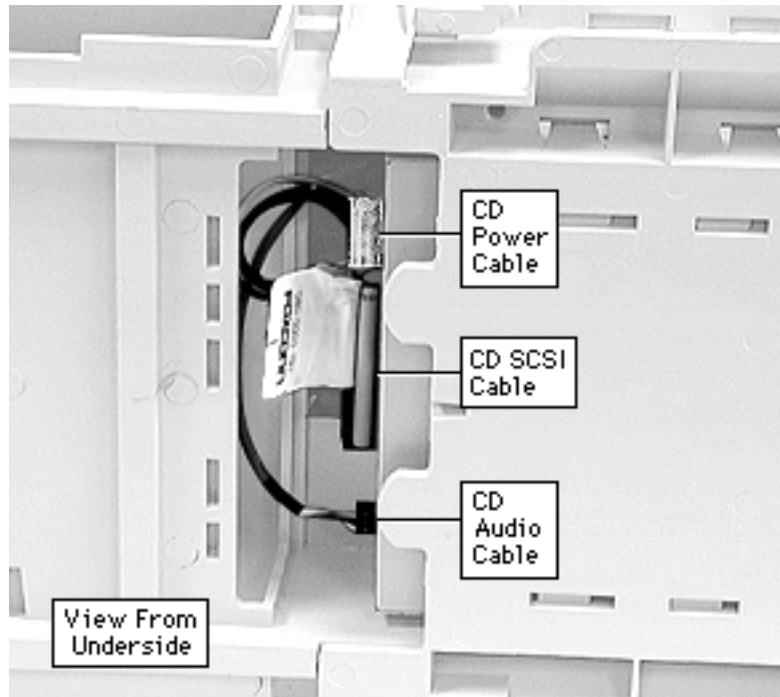

- 1 Position the chassis carrier on its side.
- 2 Disconnect the CD-ROM power cable, CD-ROM SCSI cable, and CD-ROM audio cable from the back of the CD-ROM drive.





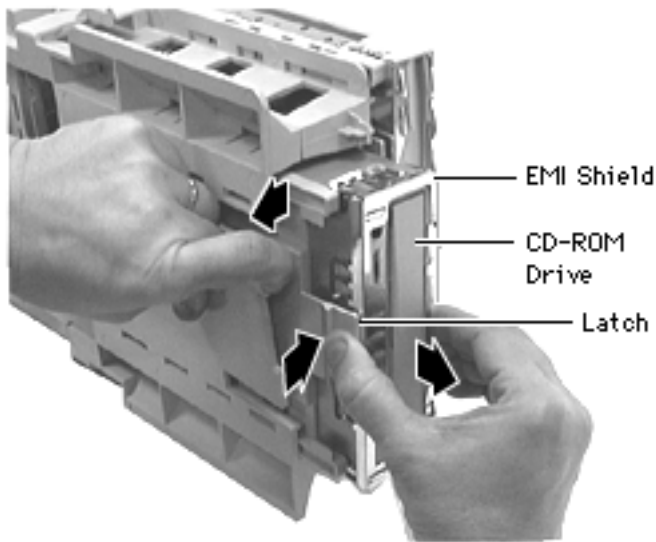

- 3 Pull down on the plastic frame while squeezing the latch. Slide the CD-ROM drive forward to remove it from the unit.

**Note:** Be sure to remove the EMI shield and CD-ROM carrier before returning the drive to Apple.



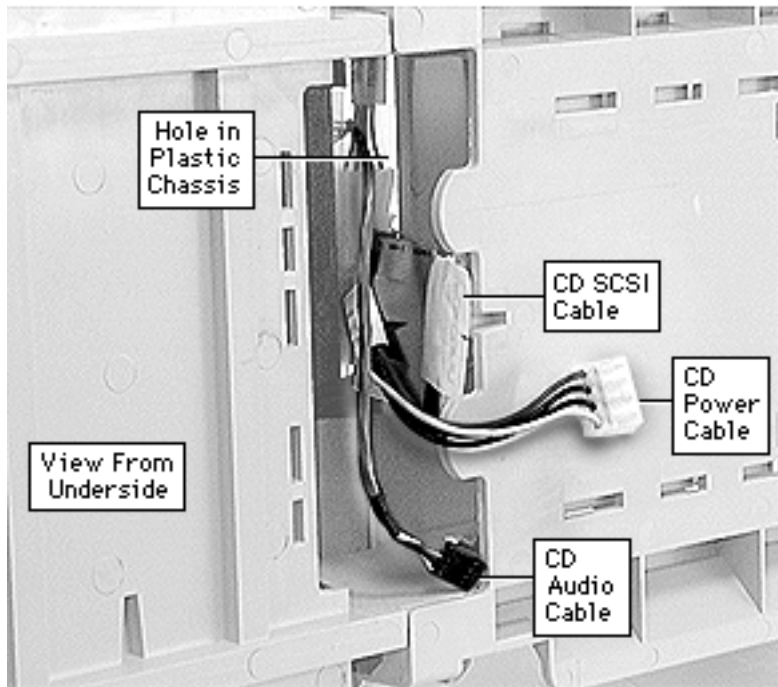

**Replacement Note:** If you removed the CD-ROM cables from the chassis you will need to reposition them before connecting the CD-ROM drive.

- 1 Tuck the CD-ROM power cable, the CD-ROM SCSI cable, and the CD-ROM audio cable through the hole in the plastic chassis.
- 2 Reconnect the cables to the CD-ROM drive.
- 3 Push CD-ROM into the chassis until it clicks into position.





## I/O Card

Before you begin, remove the chassis carrier.

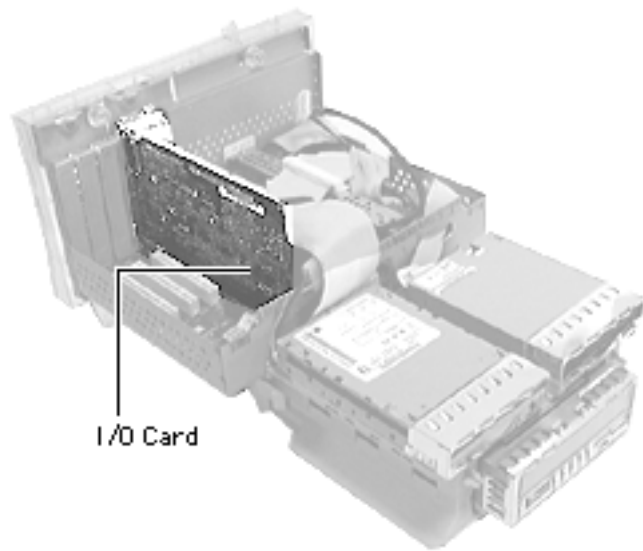

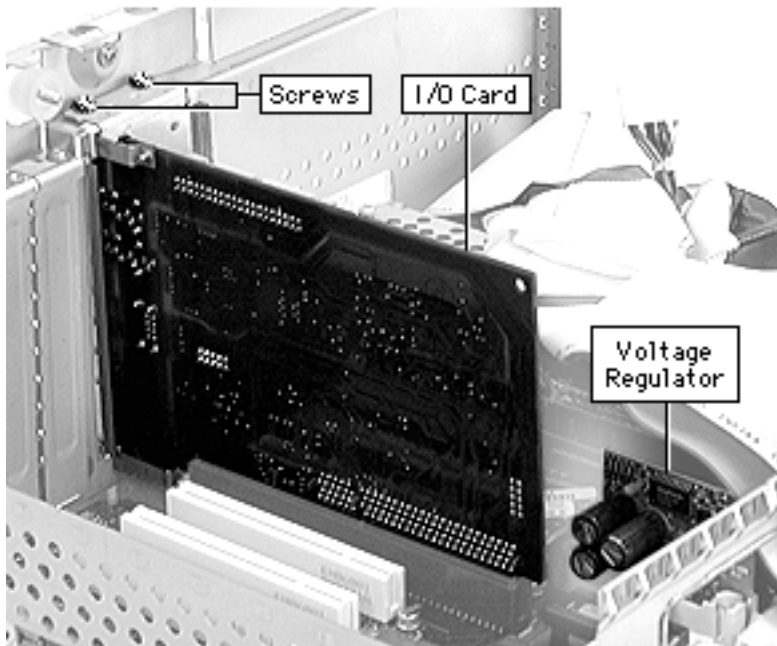

- 1 Disconnect cables on the I/O Card.
- 2 Remove two screws that secure card to chassis.

**Note:** Be careful of the voltage regulator when removing or replacing the I/O card.





- 3 Remove external I/O screw on chassis.

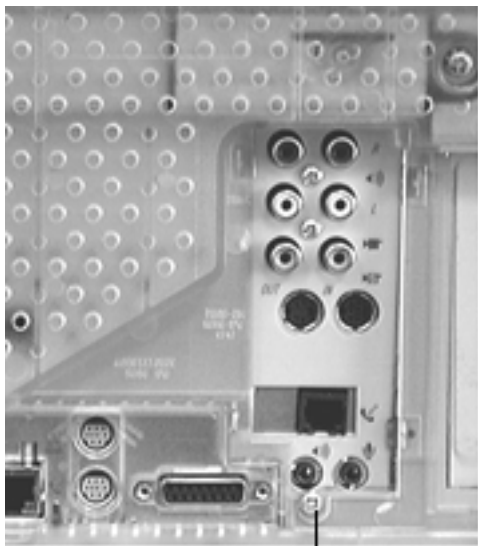

Screw



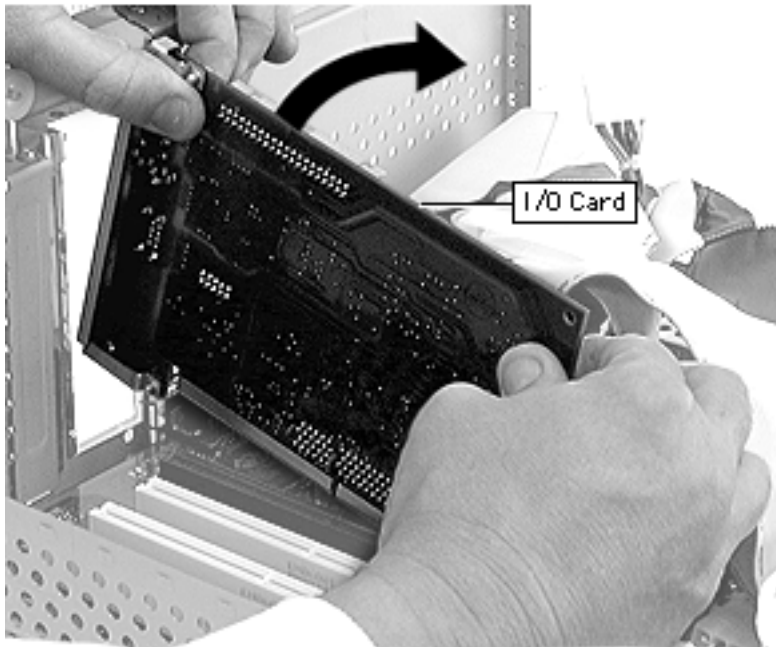

- 4 Gently rock the I/O card out of the socket.
- 5 Remove card from logic board.

**Replacement Note:** Line up back end (end nearest voltage regulator) of I/O card and push card down into slot. Be careful not to damage the voltage regulator or modem.





## Cable Support Bracket

Before you begin remove the chassis carrier.

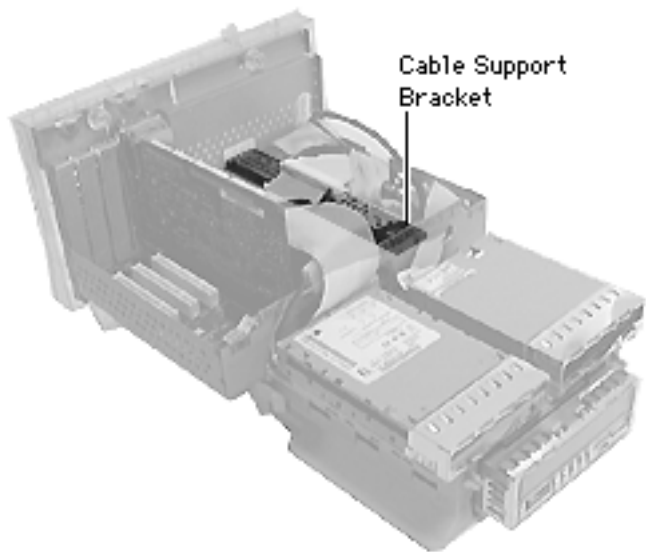



- 1 Disconnect the SCSI cable and the two IDE cables on the logic board.

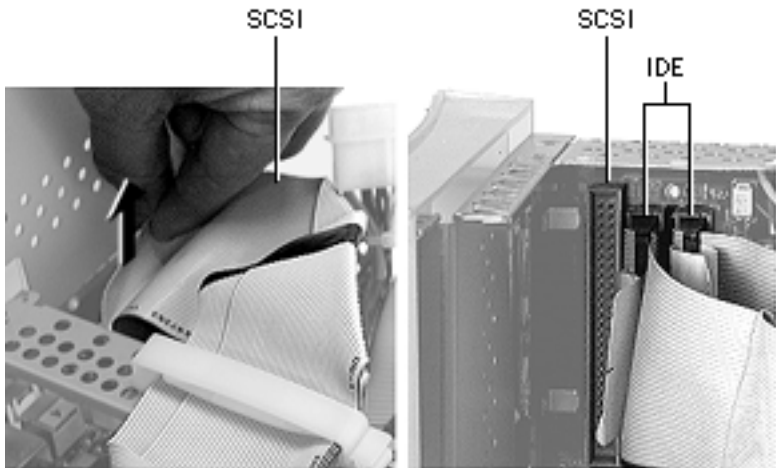



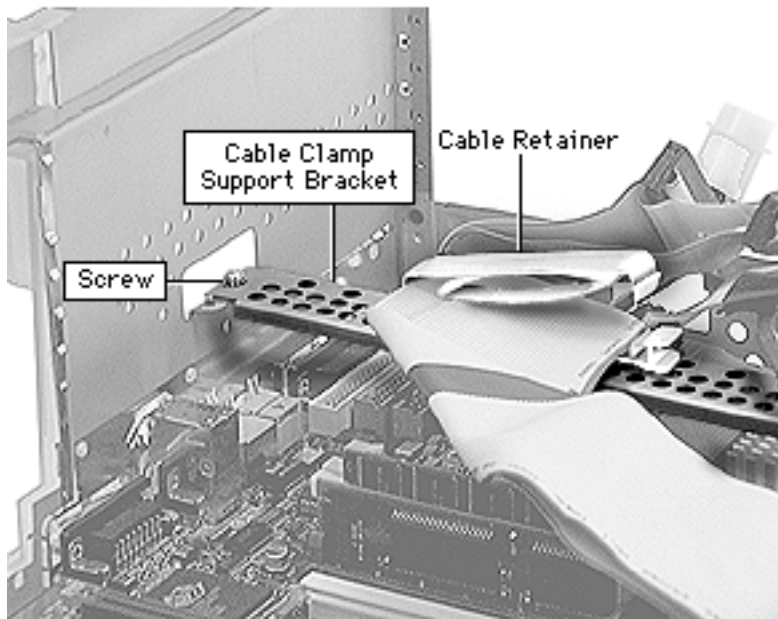

- 2 Remove screw on cable support bracket.
- 3 Open white plastic cable retainer and remove gray cables from the support bracket.
- 4 Lift the metal support bracket out of unit.



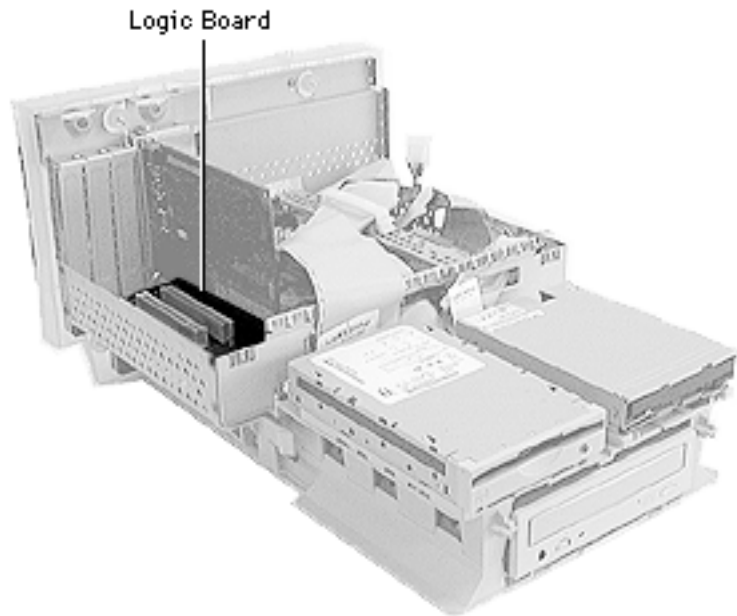

## Logic Board

Before you begin do the following:

- Remove the chassis carrier
- Remove I/O card
- Disconnect the SCSI and IDE cables
- Remove cable clamp support bracket

**Caution:** Review the ESD precautions in Bulletins/ Safety.



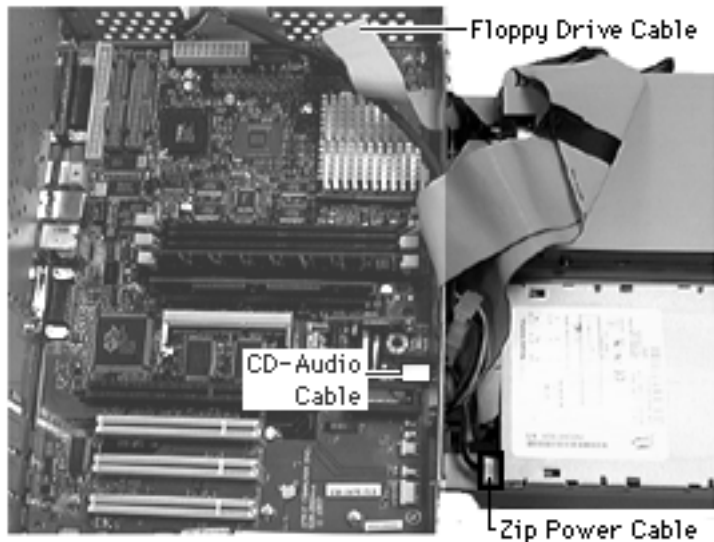

- 1 Disconnect the floppy drive cable.
- 2 Pull the Zip drive out a bit to disconnect the Zip drive power cable.
- 3 Disconnect the CD-Audio cable (located next to battery).



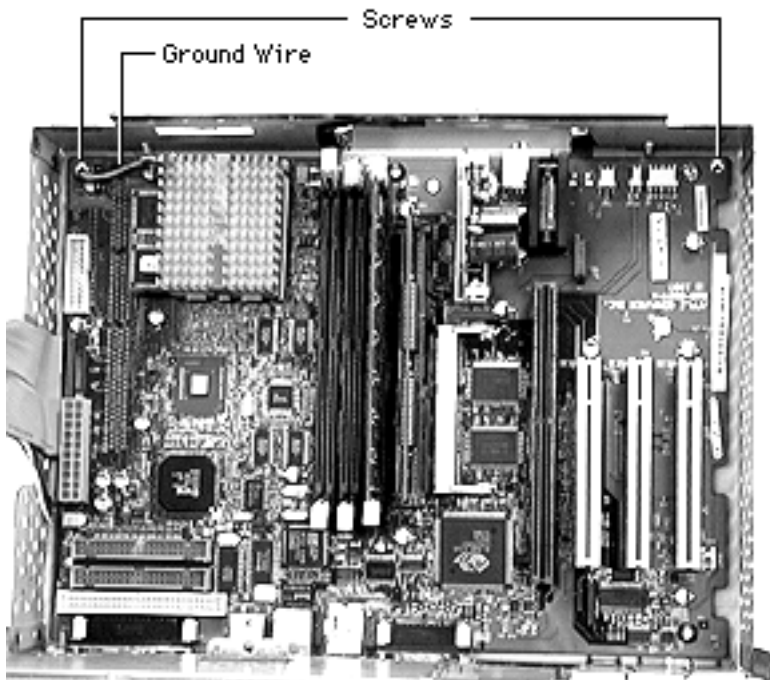

- 4 Remove the two silver screws.

**Note:** Do not remove ground wire from the heatsink.



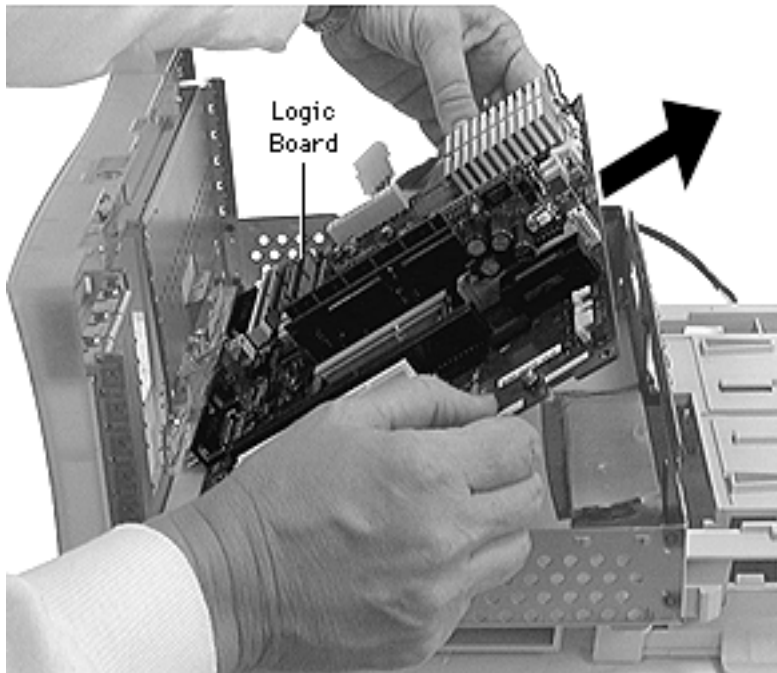

- 5 Gently lift the logic board out of the chassis carrier.



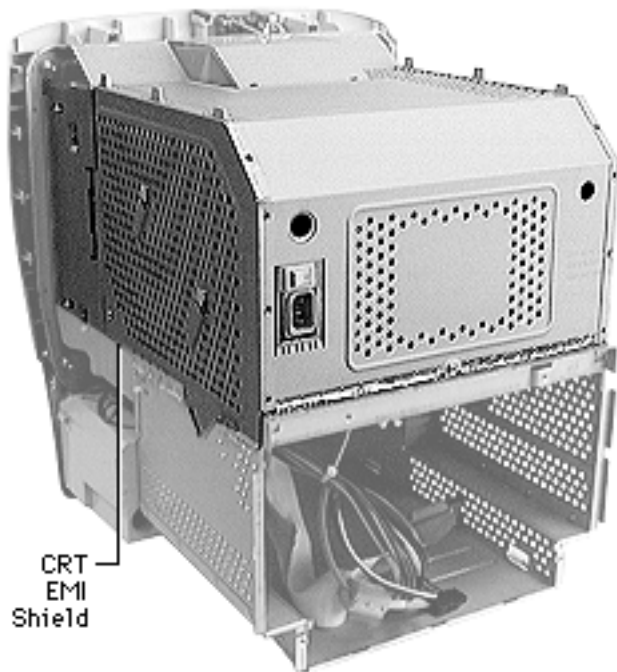

## CRT EMI Shield

**⚠ Warning:** This product contains high voltage and a high-vacuum picture tube. To prevent serious injury, review CRT safety in Bulletins/Safety.

Before you begin, do the following:

- Remove the chassis carrier
- Remove the top, side, and rear panel housing



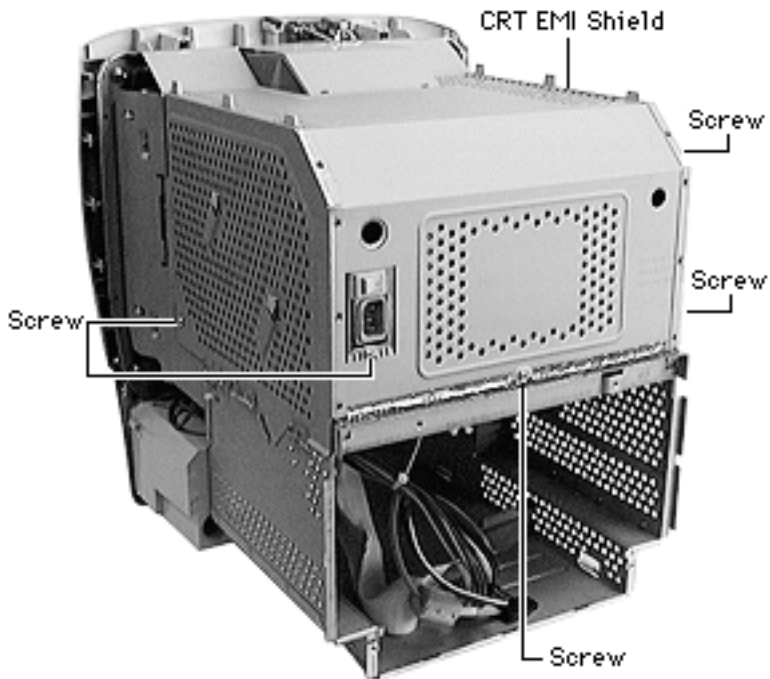

- 1 Remove the five screws on the EMI Shield.

**Note:** The EMI shield has sharp edges. Be careful not to cut yourself.



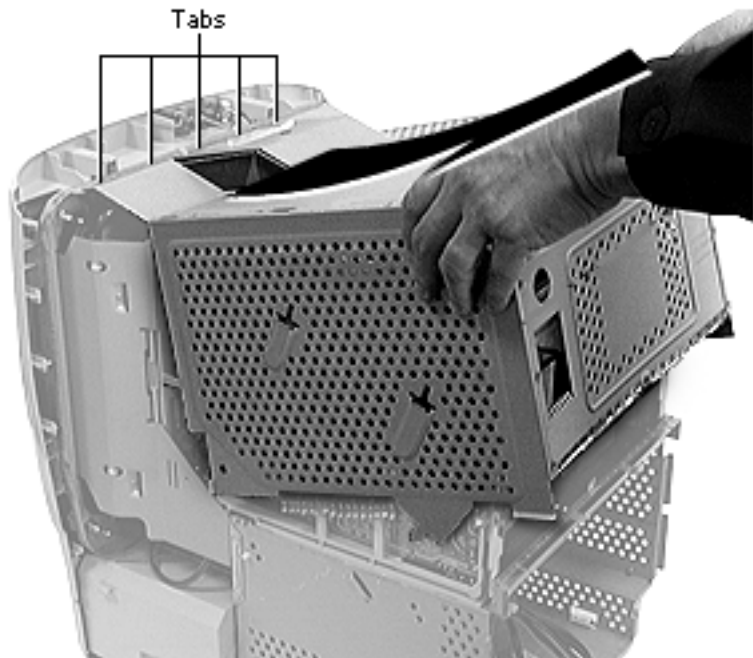

- 2 Lift the shield up, releasing the shield from the metal tabs on the chassis.
- 3 Remove the shield from the unit.

**Replacement Note:** Make sure the microphone cable is pulled through the CRT chassis frame so the EMI shield doesn't pinch the microphone cable.







## Power Supply

Before you begin do the following:

- Remove the chassis carrier
- Remove the top, side, and rear panel housing
- Remove the CRT EMI shield
- Discharge the CRT

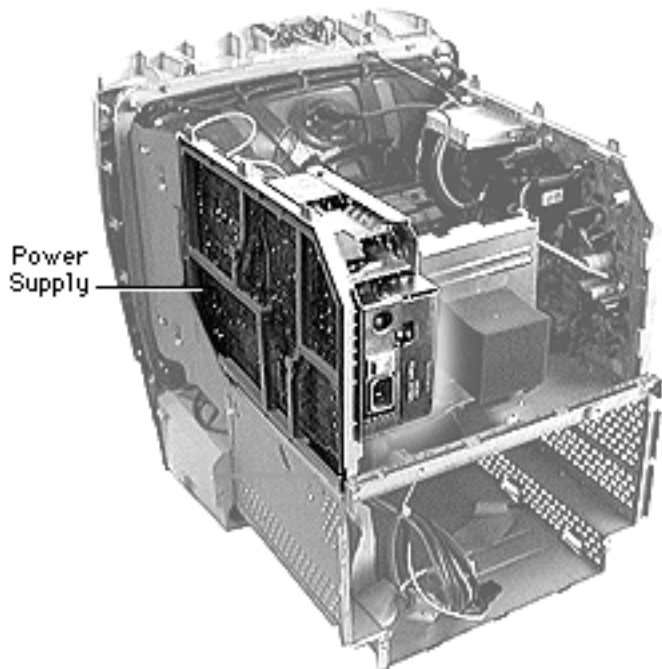

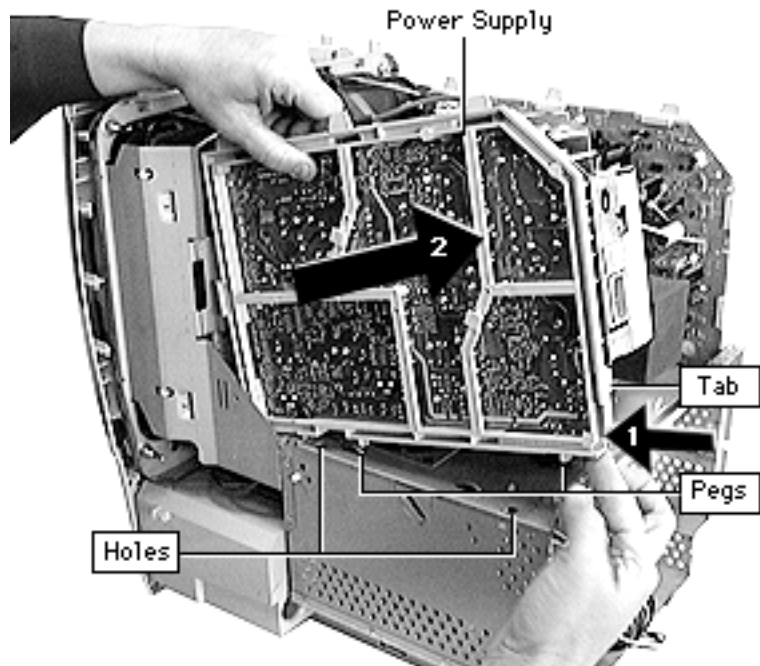

- 1 Push tab in.
- 2 Lift and pull the power supply up to clear the pegs from the chassis holes.

**Note:** The cables are still attached to the power supply at this point.



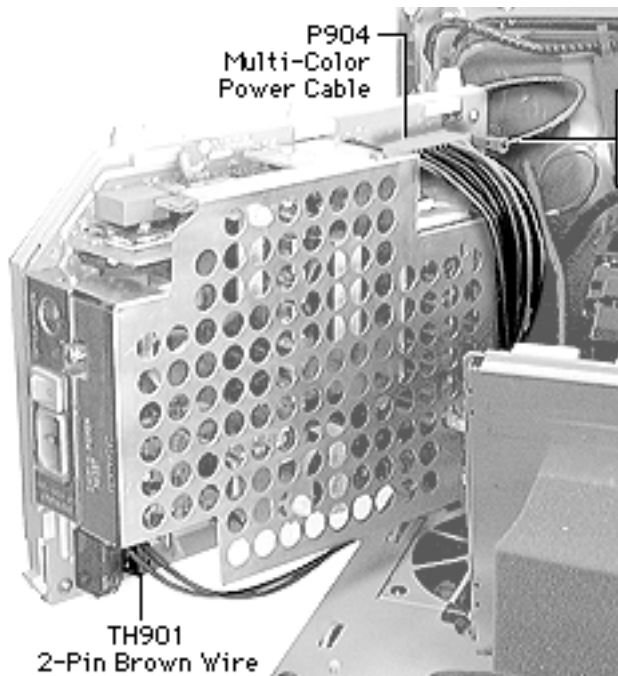

- 3 Disconnect the multi-colored power cable (P904), the ground wire (P911), and the 2-pin brown wire (TH901), from the power supply.



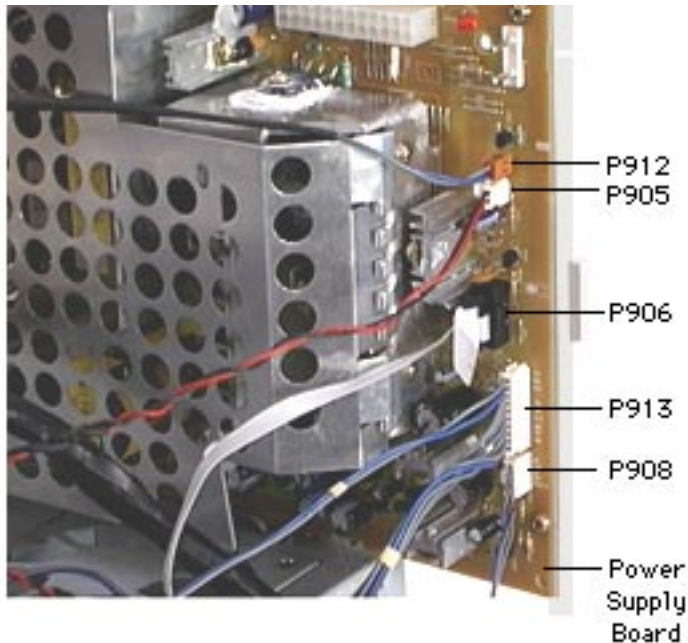

- 4 Tilting the power supply off to the side, disconnect the remaining cables on the power supply board:

- P912
- P905
- P906
- P913
- P908

**Note:** P906 and P908 have locking connectors. Pinch or squeeze to release the connectors.

- 5 Remove power supply from the chassis.



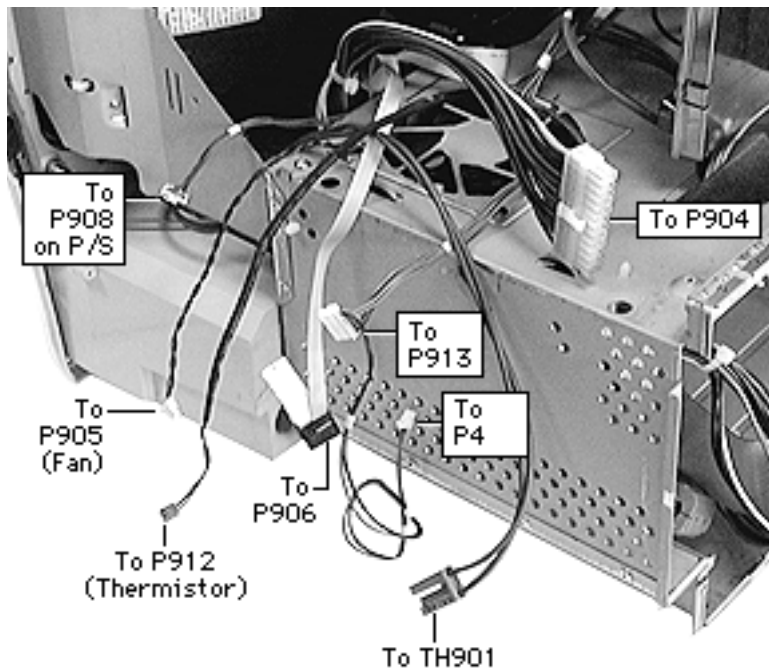

**Replacement Note:** Some connectors are impossible to reconnect when the board is in place. Before inserting the power supply, connect cables TH901, P908, P913, P906, and P905. Also, make sure the pegs on the power supply reset into the holes in the chassis.



**Additional cable descriptions:**

**P912:** Thermistor cable: a 2-wire gray & brown cable that connects to the brown connector on the power supply board

**P905:** Fan cable: a 2-wire red & black cable

**P906:** a flat gray ribbon cable (922-3492). This cable is a wide gray ribbon cable that connects to the I/O card and then splits off into three cables, one goes to the front panel board, one to the power supply board (P906), and one to the analog board (P503).

**P913:** a 10-wire gray & blue cable (2 wires from this cable split off and connect to P4 on the front panel board and the other end connects to P505 on the analog board)

**P908:** a 5-wire gray & blue cable (P908 connects to P507 on the analog board)



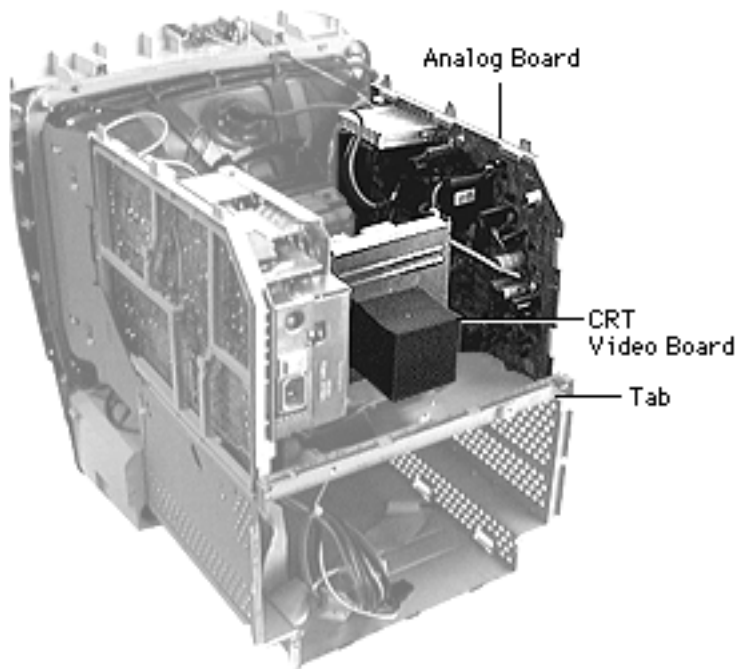

## Analog/Video Board

Before you begin do the following:

- Remove the chassis carrier
- Remove the top, side, and rear housing
- Remove the CRT EMI shield
- Discharge the CRT
- Disconnect anode cap



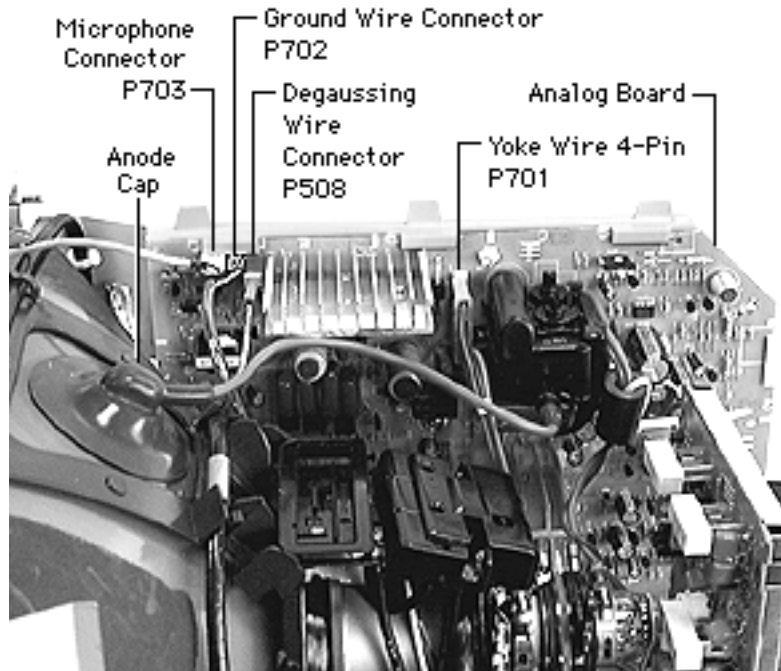

- 1 Disconnect the microphone (P703), ground wire (P702), degaussing wire (P508), and the yoke wire (P701).







CRT Video Board

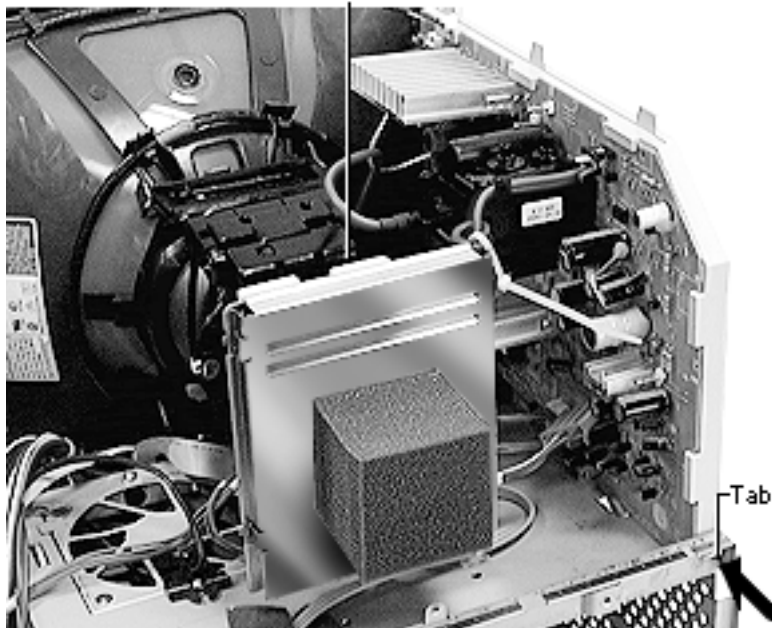

- 2 Gently remove the CRT video board.
- 3 Push in tab and lift analog board out of chassis holes.



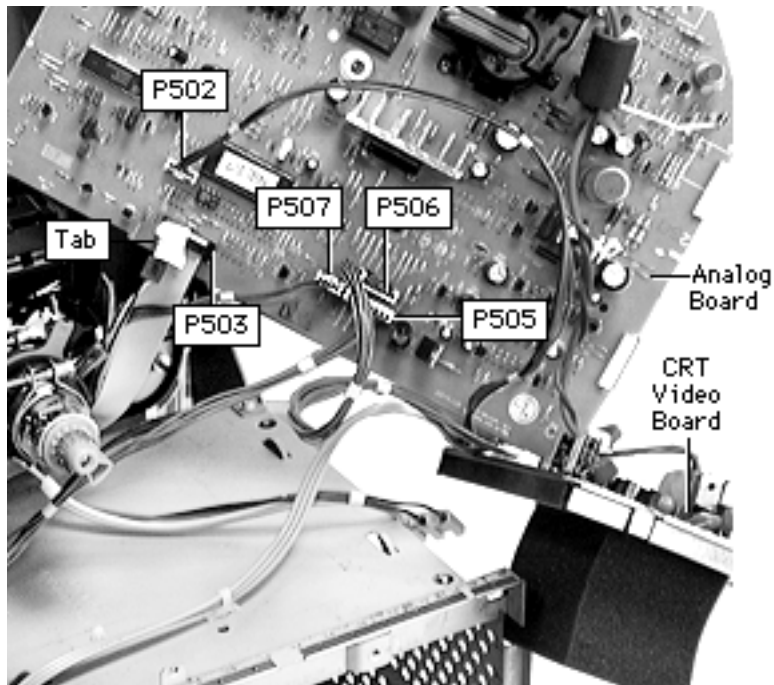

- 4 Disconnect P502, P503, P507, P506, and P505.

**Important:** P502, P503, P507, and P506 have clamped (or locking) connectors. Pinch or squeeze to release these connectors.

- 5 Remove analog/CRT video board from chassis.

**Note:** See next page for cable connection information.





On the analog board:

- P502 connects to P305 on the CRT video board
- P503 connects to P906 on power supply
- P505 connects to P913 on the power supply
- P507 connects to P908 on the power supply
- P506 connects to P302 on the CRT video board





## CRT Bezel

Before you begin, remove the following:

- Top, side, and rear panel housing.
- Front door



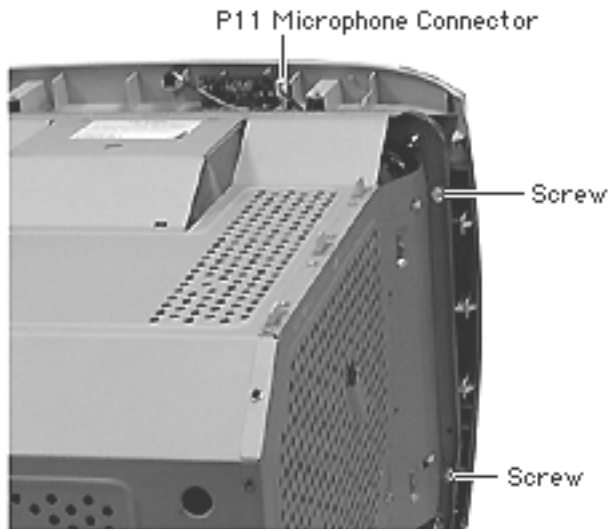

- 1 Remove the two silver torx screws located on each side of the CRT.
- 2 Disconnect the microphone cable (P11) from the microphone board.
- 3 Pull bezel off the chassis.





## Speakers

Before you begin do the following:

- Remove the top, side, and rear panel housing
- Front door
- CRT Bezel
- Front panel board



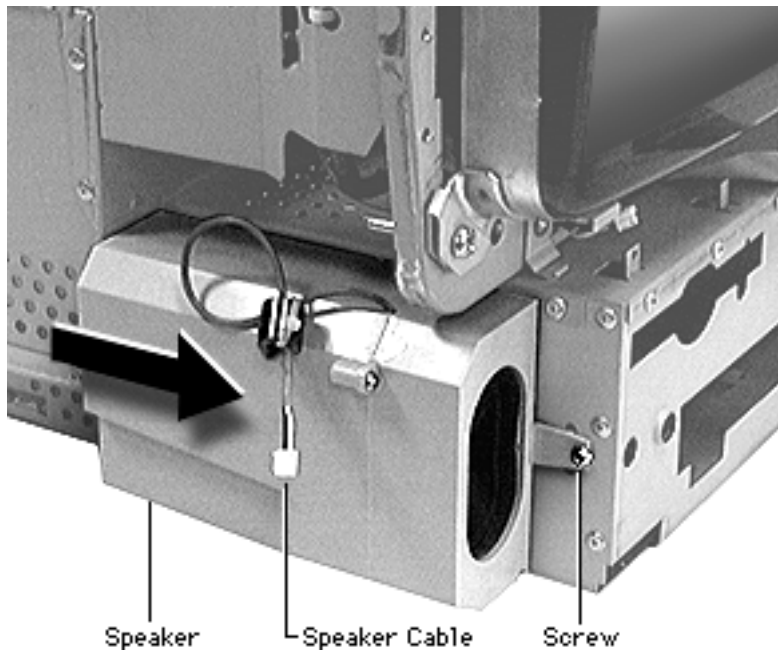

- 1 Remove speaker screw.
- 2 Speaker cable should be disconnected from sound board; gently pull speaker cable out from underneath the CRT.
- 3 Slide the speaker forward to remove it from the chassis.
- 4 Repeat steps 1-3 to remove opposite speaker.





## Front Panel Board

Before you begin do the following:

- Remove the top, side and rear panel housing
- Front door
- CRT bezel

1 Remove two screws.

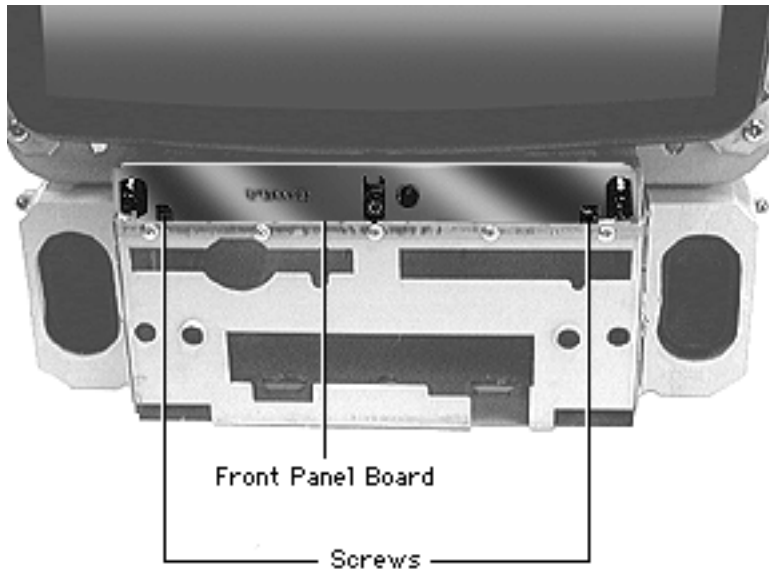



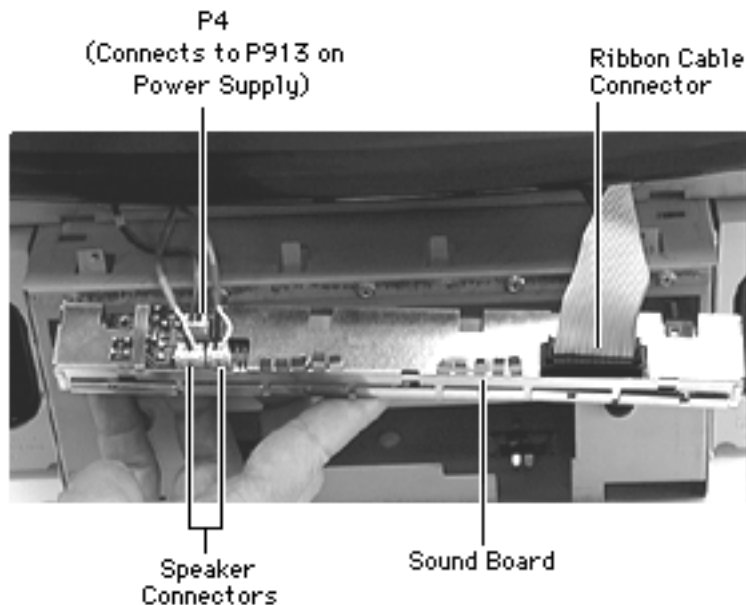

- 2 Pull front panel board forward to disconnect the three cables and ribbon connector.
- 3 Remove front panel board from chassis.



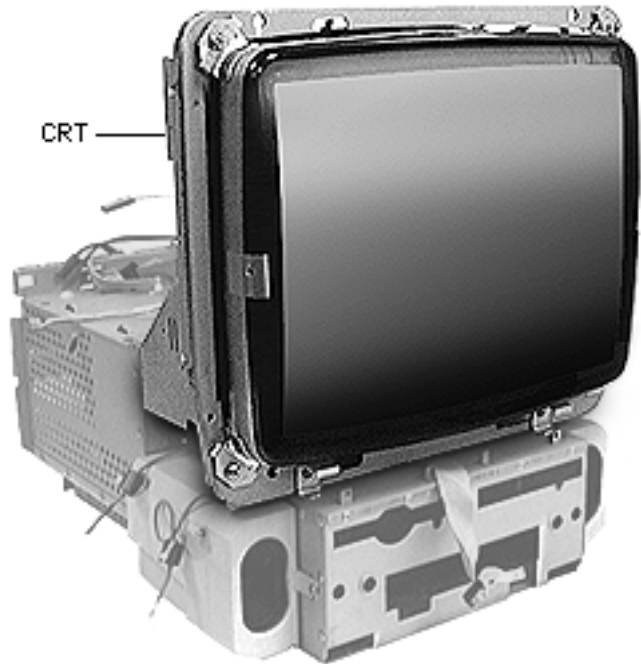

## CRT

**⚠ Warning:** This product contains high voltage and a high-vacuum picture tube. To prevent serious injury, review CRT safety in Bulletins/Safety.

Before you begin do the following:

- Remove the chassis carrier
- Remove the top, side, and rear panel housing
- Remove the CRT EMI shield
- Discharge the CRT





- Remove the analog board
- Remove the power supply
- Remove the front door
- Remove the CRT bezel
- Remove front panel board



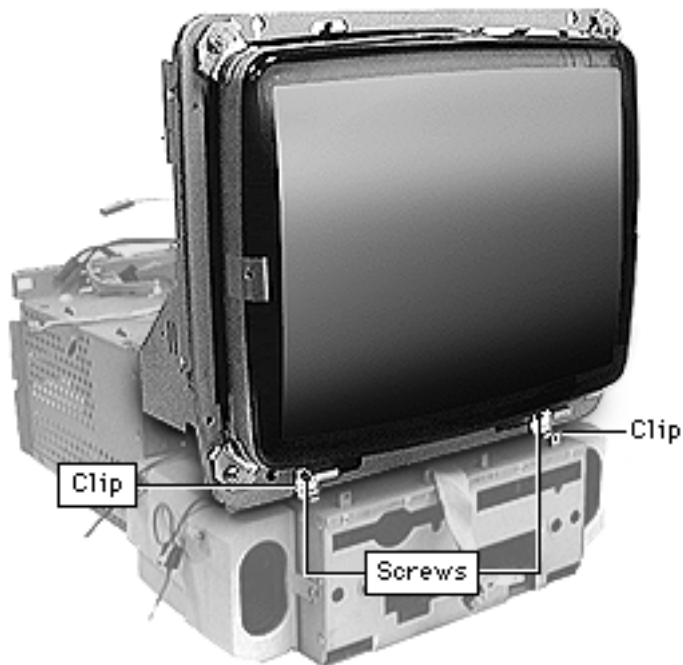

- 1 Remove the screws that secure the clips.
- 2 Remove clips.



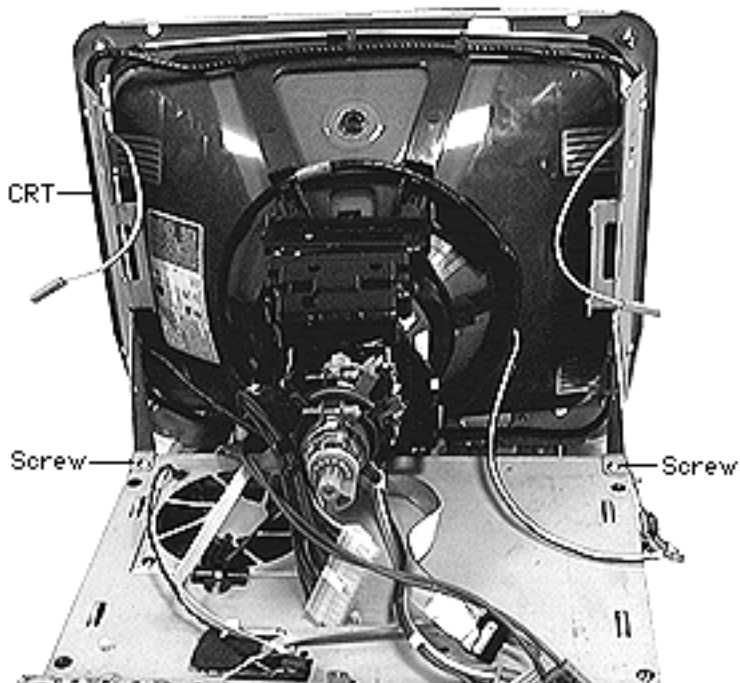

- 3 Remove two screws that secure the CRT frame to the main chassis.



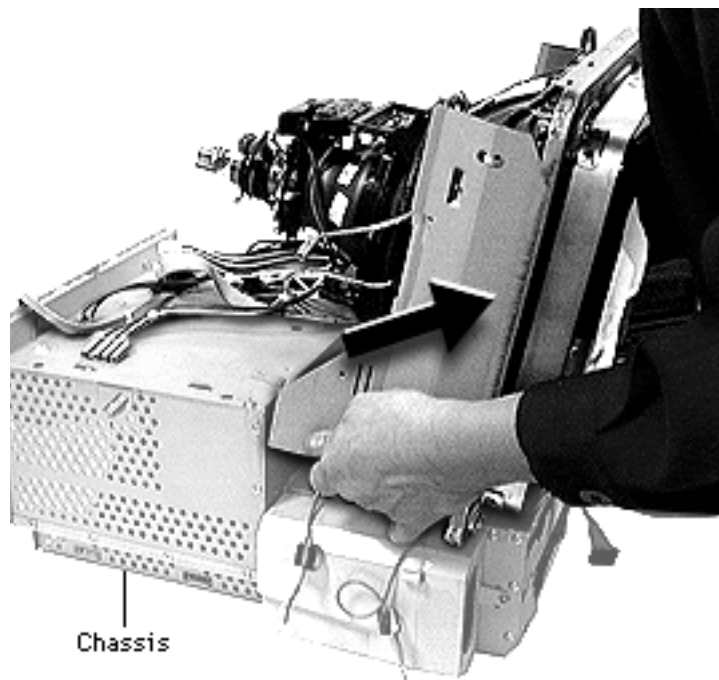

Chassis

- 4 Securely hold CRT and lift CRT off the chassis.



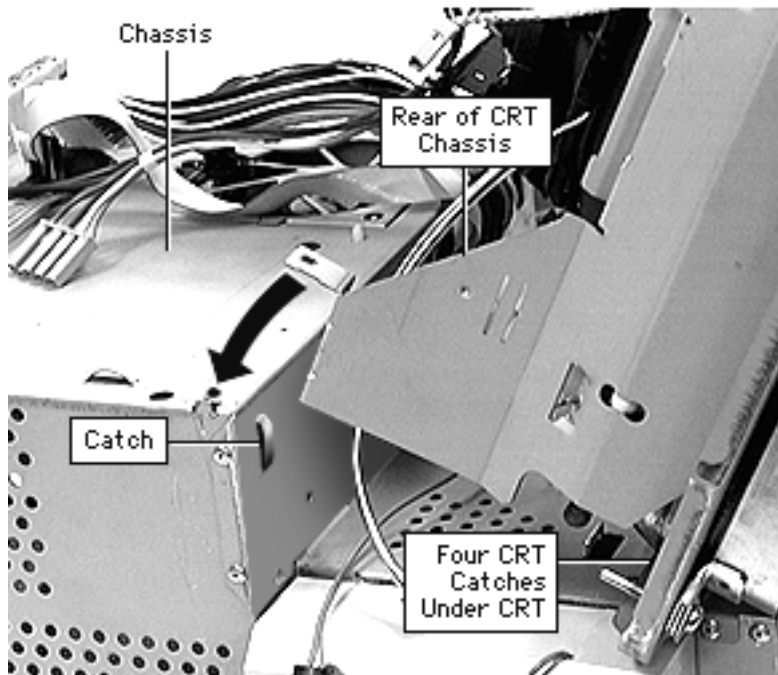

**Replacement Note:** Position bottom of CRT so the CRT frame connects with the four chassis catches under the front of the CRT.

Continue lowering the CRT frame onto the main chassis. Squeeze the rear of the CRT chassis frame inward so it fits inside chassis catches on either side.

Attach screw (one on other side also) where black arrow is pointing.



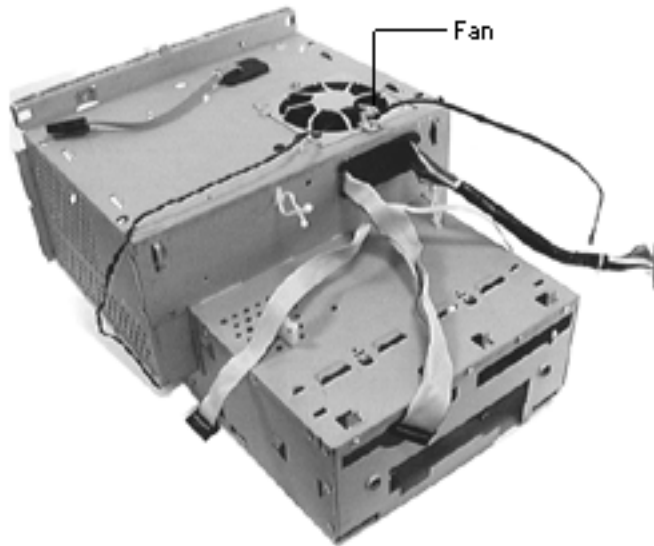

## Fan

Before you begin, do the following:

- Remove the chassis carrier.
- Remove the top, side, and rear panel housing.
- Remove the CRT EMI shield
- Discharge the CRT
- Remove the analog board
- Remove the power supply





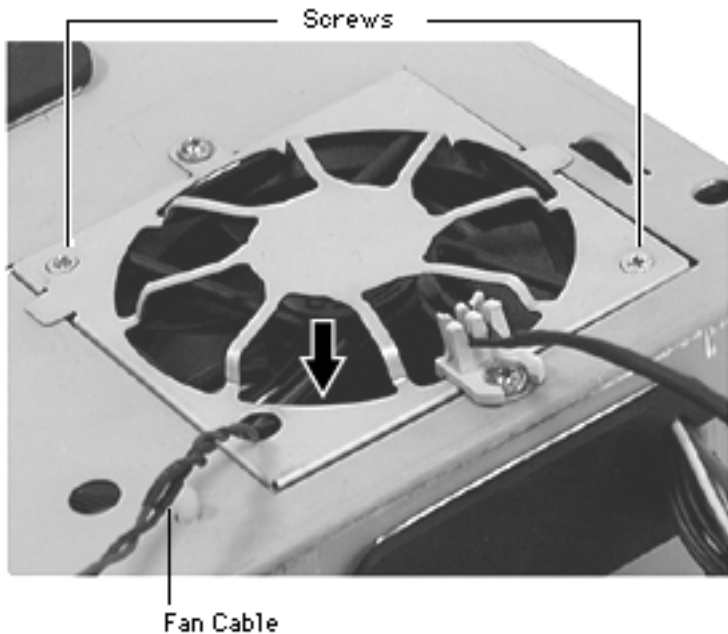

- 1 Position hand inside chassis to catch fan as it drops down when the two fan screws are removed.
- 2 Remove fan from chassis.





## Thermistor

Before you begin, do the following:

- Remove the chassis carrier.
- Remove the top, side, and rear panel housing.
- Remove the CRT EMI shield
- Discharge the CRT
- Remove the analog board
- Remove the power supply

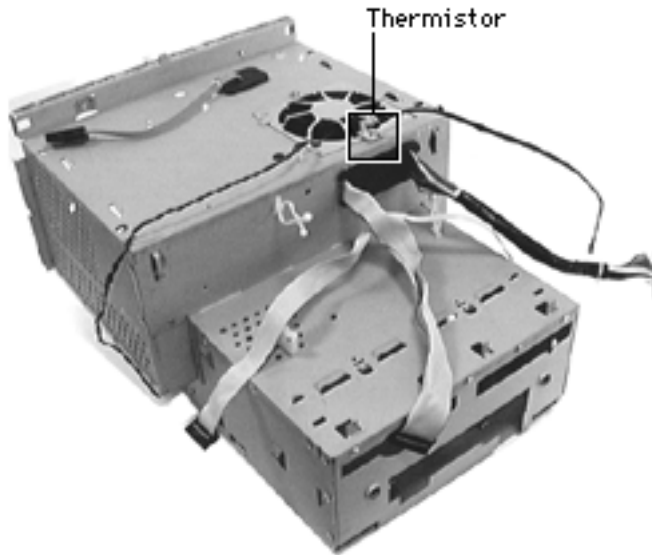

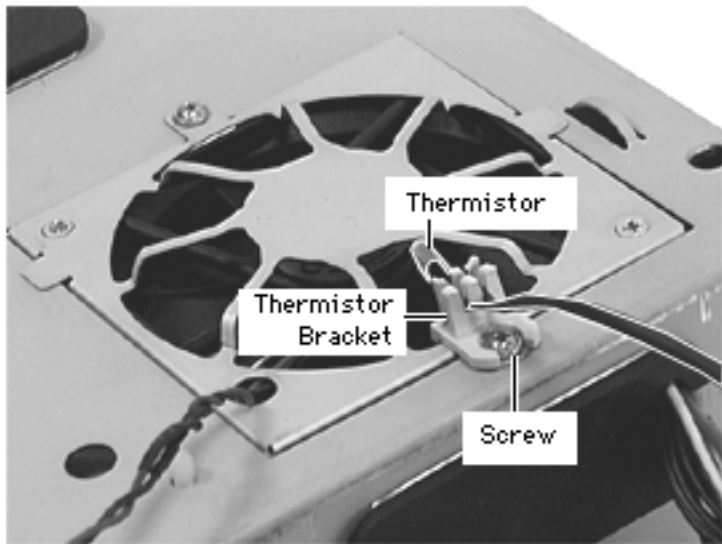

- 1 Remove screw on thermistor bracket.
- 2 Remove bracket; remove thermistor.





## Chassis w/ Cables

Before you begin do the following:

- Remove the chassis carrier
- Remove the top, side, and rear housing
- Remove the CRT EMI shield
- Discharge the CRT
- Remove the analog board
- Remove the power supply
- Remove the CRT bezel
- Remove the front door
- Remove the CRT
- Remove fan and thermistor

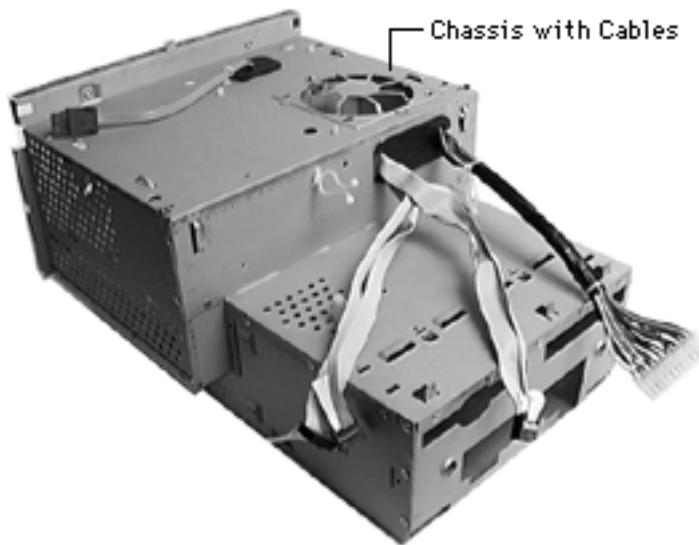



- Remove Tilt /Swivel Base

The chassis and three cables remain. The chassis with cables is part number 922-3489.

**Note:** These cables are available separately:

- Main power cable (922-3481)
- RGB cable (922-3480)
- Cable to I/O, front panel, analog, p/s (922-3492)

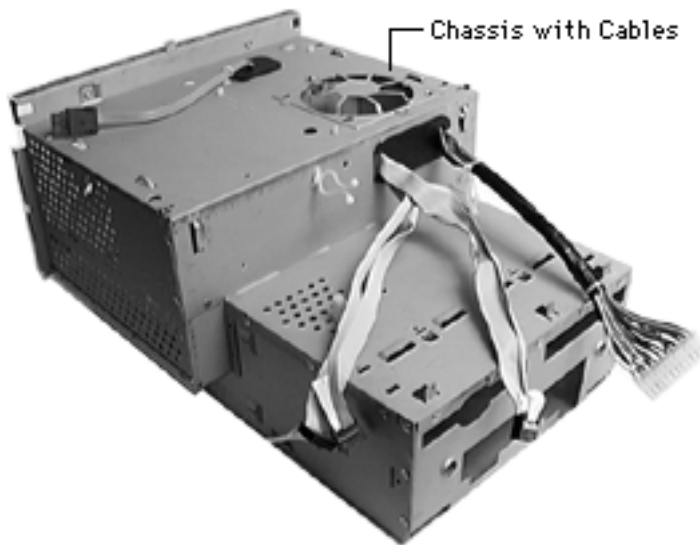



## Processor Module

Before you begin, do the following:

- Remove the chassis carrier
- Remove I/O card
- Remove cable clamp support bracket

**Caution:** Review the ESD precautions in Bulletins/ Safety.

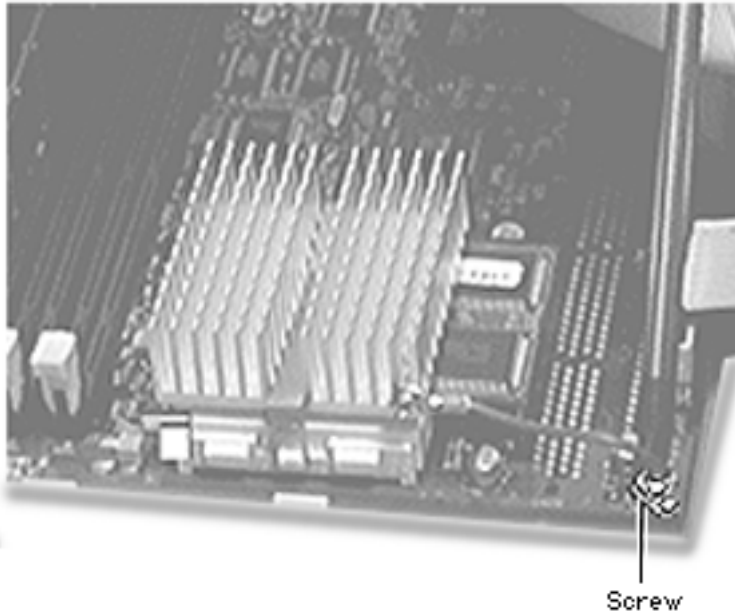

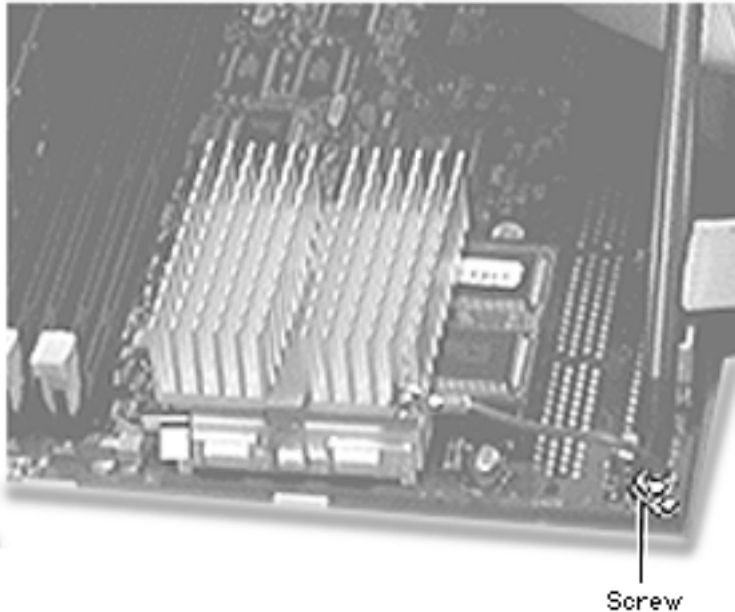

- 1 Remove the screw that holds the processor module wire to the logic board.

**Replacement Note:** The processor module wire attaches to the top of the logic board (not underneath). When screwing down the wire, be careful not to damage the capacitor that is next to the screw hole. Use a manual screw driver to avoid damaging the capacitor.



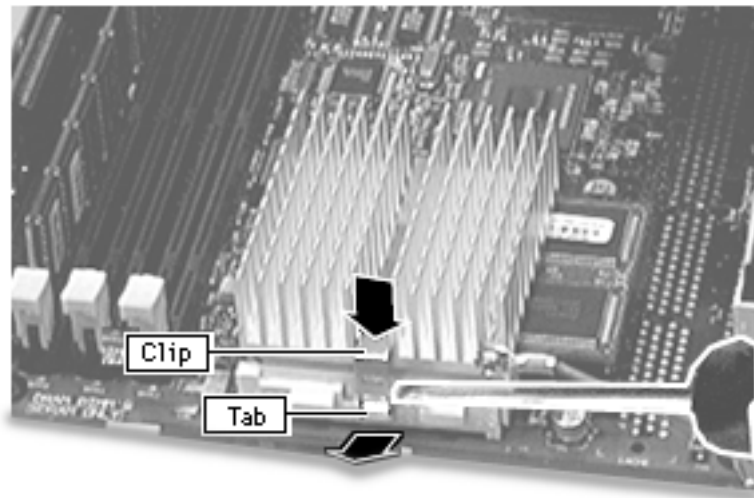

**Warning:** the heat sink may be hot to the touch.

- 2 While pressing down on the top of the clip that secures the heatsink, use a small flatblade screwdriver to lift up on the front tab of the clip to release it.





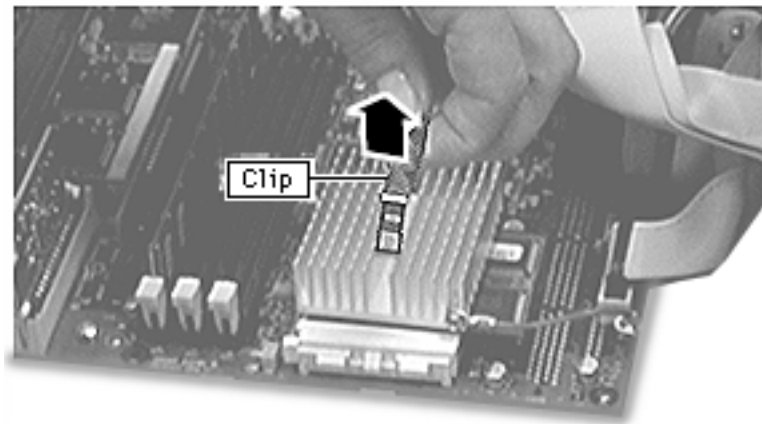

- 3 Lift up the clip and remove it from the heatsink.





- 4 Lift up the heatsink to remove it from the processor module.

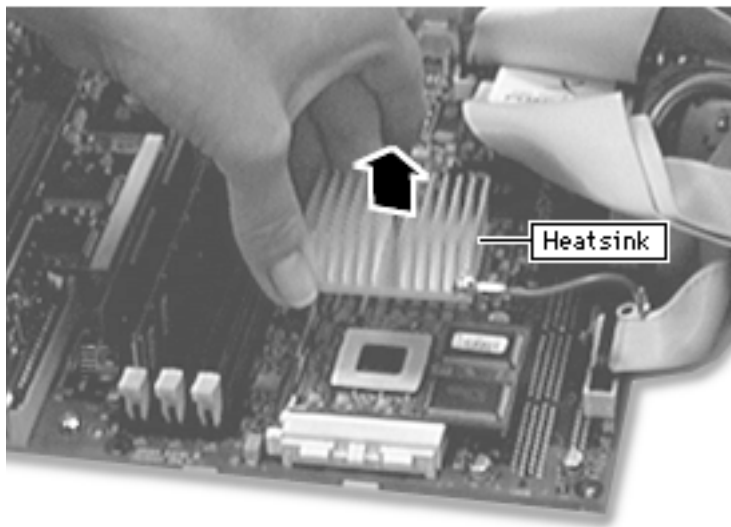

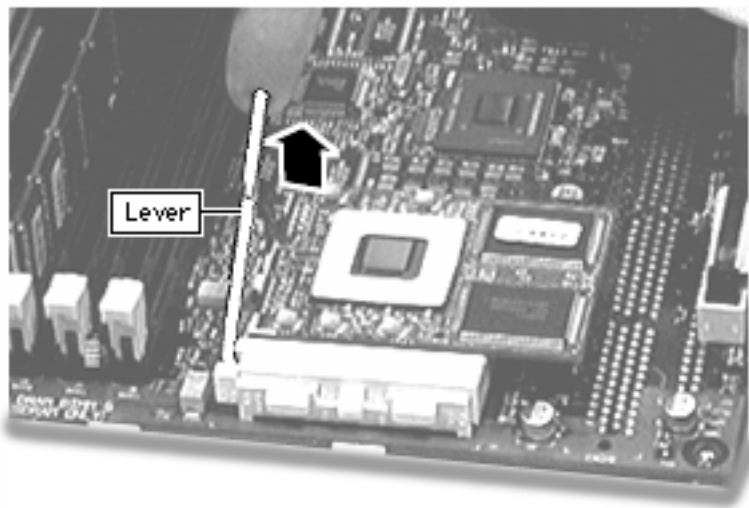

- 5 Lift the metal lever at the left of the processor module.



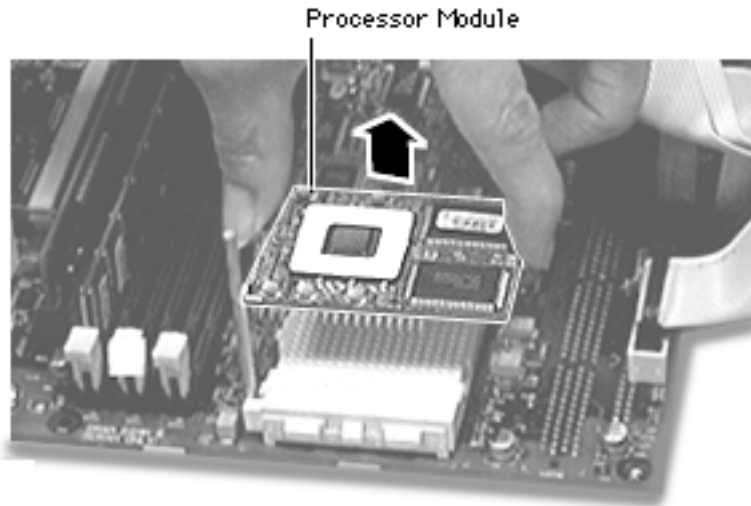

- 6 Pick up the processor module by the edges and gently lift straight up to remove it. Be careful not to bend the pins underneath the module.

**IMPORTANT:** If you are only replacing the processor module, stop here. If, however, you are removing the processor module in order to replace the logic board, continue on to the next page.

**Replacement Note:** Don't force the processor module.

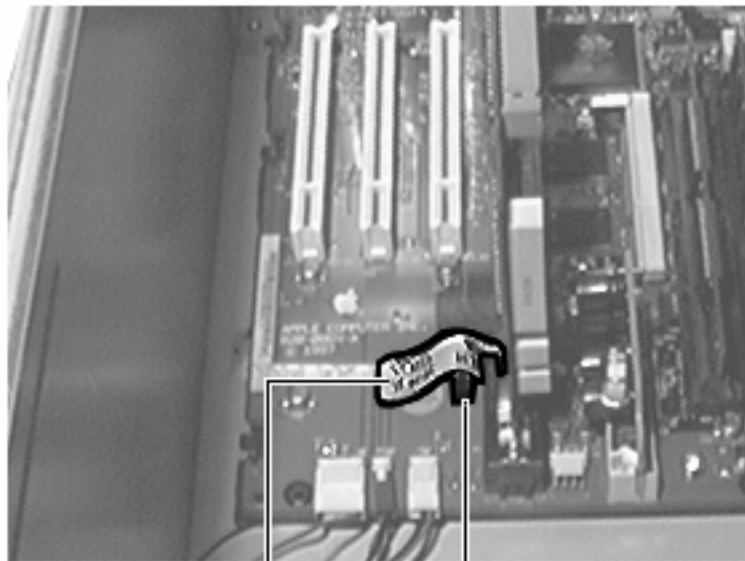

Warranty  
StickerJumper  
Block

- 7 Remove the warranty sticker and red jumper block located next to the battery if replacing the logic board only.

**IMPORTANT:** When replacing the processor module, you must change the processor jumper block and warranty sticker to be compatible with the processor module you are installing. Failure to install the jumper block properly will result in a unit that does not power on. See the instructions on the following page.





- 8 The graphic at left shows the proper installation for the processor module jumper. Depending on the unit, you will either install a red jumper block (for the 233 MHz configuration) or a white jumper block (for the 266 MHz configuration). Be sure to cover the pins as shown and to install the jumper block with the gold connector pins facing down towards the board.

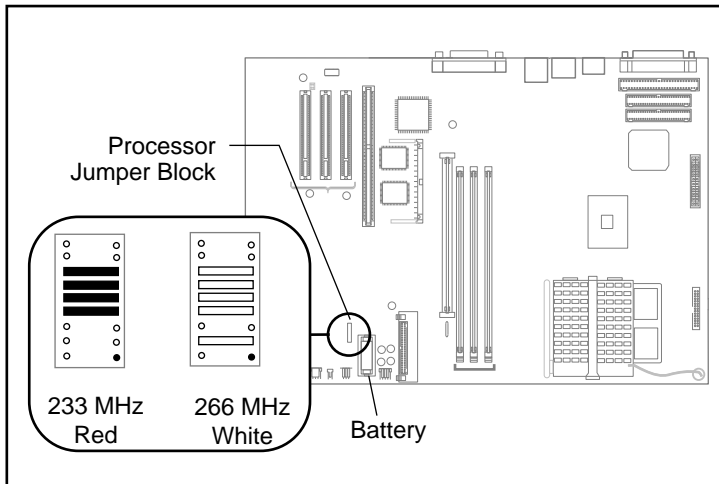



**Replacement Note:** Position the processor module evenly over the processor module slot and make sure the card is seated evenly. Press down gently on the processor module to install it. Never force the module into place or you may damage the gold connector pins on the underside. Flip down the metal lever that secures the processor module to the board.

Replace the heat sink on top of the processor module. Secure the heat sink by inserting the clip into the slot at the rear of the processor and then swinging the clip down over the heat sink. Press the clip into the front latch to fasten in place.





## Front Door

There are no first remove procedures for the front door.





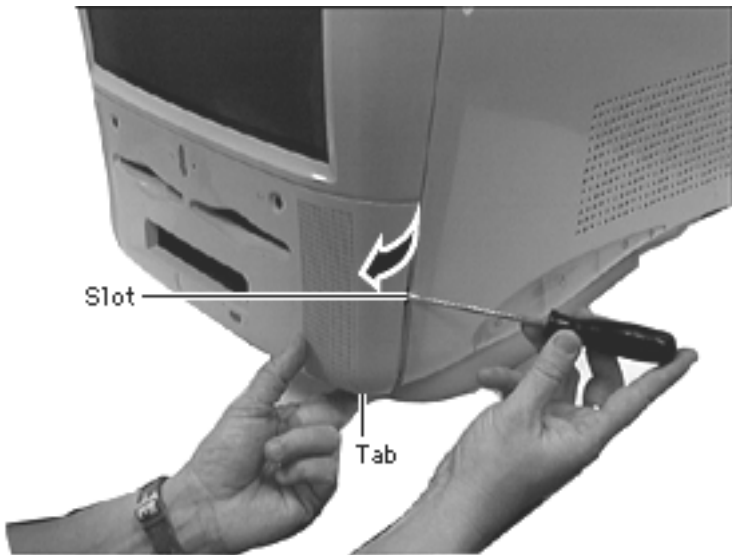

- 1 Pull down on the bottom tab while at the same time gently pry the side slot with a screwdriver to release the front door.
- 2 If necessary, repeat step one for the other side.
- 3 Remove front door from bezel.

**Note:** Plastic tabs on underside of front door are fragile. Be careful not to break them.





## Housing

Before you begin, do the following:

- Remove the chassis carrier
- Remove the front door

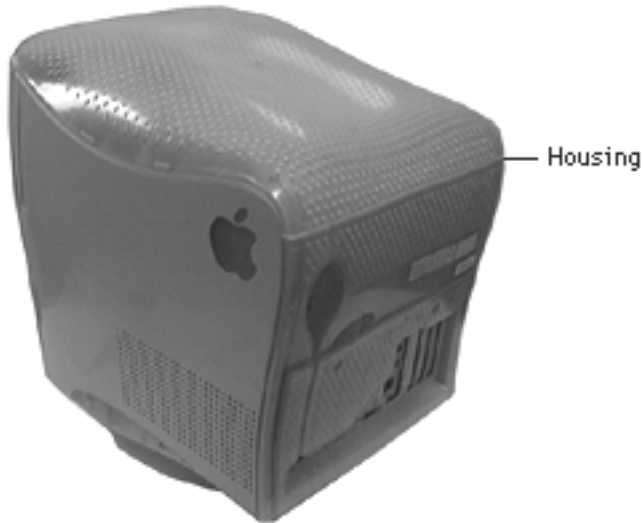



- 1 Remove the four screws on the CRT bezel to release the housing from the CRT bezel.

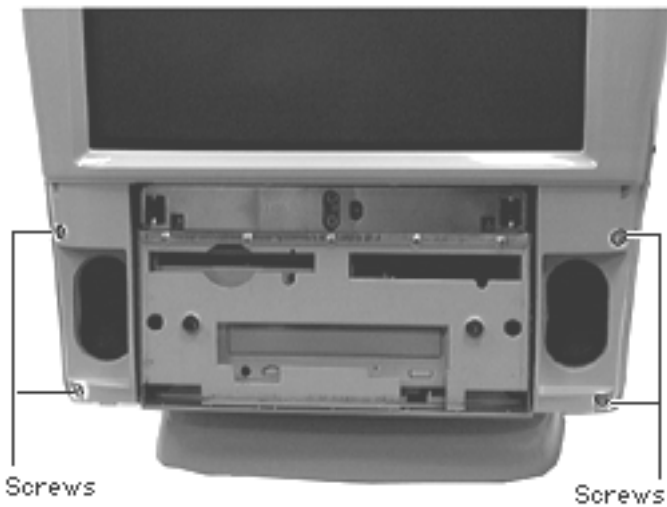

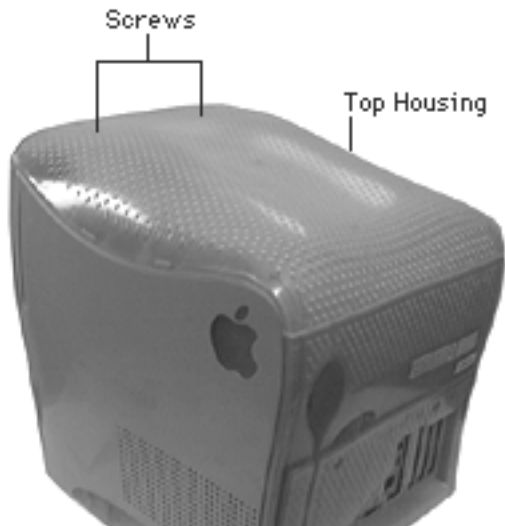

- 2 Remove the two plastic plugs covering the top panel housing screws.
- 3 Remove the two screws.



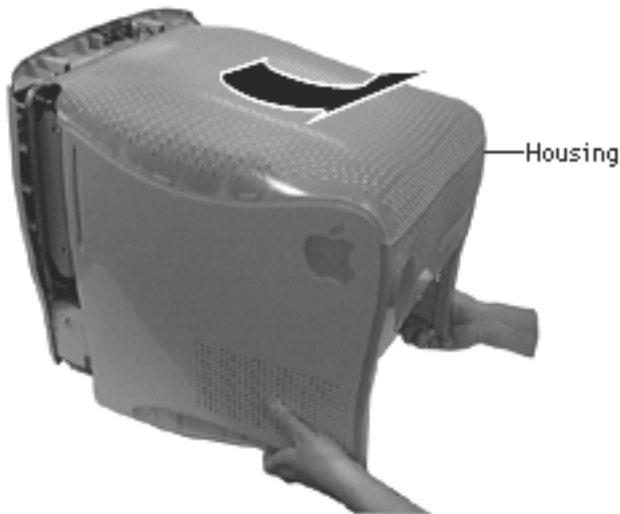

- 4 Pull housing back and lift housing off computer.

**Note:** The housing is removed as one unit, but separates into four parts: the top panel housing (922-3476), rear panel housing (922-3475), left side housing (922-3474), and right side housing (922-3473).

See next page for individual housing screw locations.



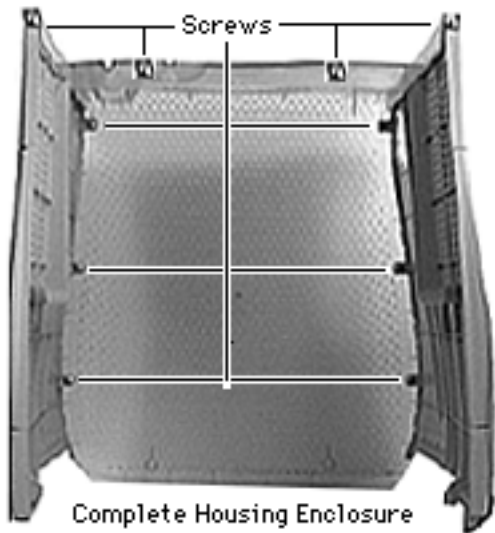

**Note:** This picture is a view looking inside the housing.

- 5 Remove screws (10) to separate housing into individual panels.





## Tilt/Swivel Base

Before you begin, do the following:

- Remove the front door
- Remove the CRT bezel
- Remove the housing





- 1 Remove two screws.
- 2 Slide tilt/swivel base up and off the unit.

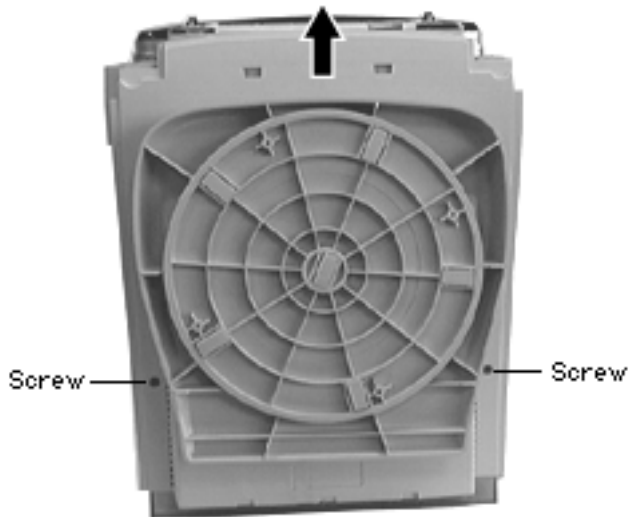





# Troubleshooting

Power Macintosh G3  
All-In-One





## General

The Symptom Charts included in this chapter will help you diagnose specific symptoms related to your product. Because cures are listed on the charts in the order of most likely solution, try the first cure first. Verify whether or not the product continues to exhibit the symptom. If the symptom persists, try the next cure. (Note: If you have replaced a module, reinstall the original module before you proceed to the next cure.)

If you are not sure what the problem is, or if the Symptom Charts do not resolve the problem, refer to the Flowchart for the product family.

For additional assistance, contact Apple Technical Support.





## New Components Theory of Operation

New components on the Power Macintosh G3 logic boards and new strategies for parts replacement make troubleshooting these systems significantly different from previous models. Take a moment to read and understand how each of these new components interacts with the system.

### **Voltage Regulator**

The voltage regulator module regulates the voltage for the particular processor used in different Power Macintosh G3 systems. This system provides an easy way to regulate voltage without changing specific resistor values on the logic board. When you order the Power Macintosh G3 logic board from Service, the voltage regulator comes with the board. You can also order the voltage regulator as a separate part.





## Processor Module

The Power Macintosh G3 logic board comes with a removable processor module. You can replace this module when the logic board or processor module fails. The processor module sits in a ZIF socket for easy removal. Processor modules can be ordered from Service, and each is shipped with the appropriate jumper configuration block to place in location J16. The processor should rarely fail. Replace it only as a last resort.

When replacing the processor module, you must change the processor jumper block and warranty sticker to be compatible with the processor module you are installing. Failure to install the jumper block properly will result in a unit that does not boot up. Refer to “Processor Module” in Take-Apart for installation instructions.





## Jumper Location J16

The jumper block you place at location J16 configures the board to work with different processor modules. Use the appropriate jumper block, identified by color, for each processor module. Refer to “Processor Module” in Take-Apart for installation instructions.

Processor Speed	Jumper Color
233	Red
266	White

The jumper block is protected by a void-warranty sticker. End users are not allowed to remove this jumper block. If the sticker has been tampered with on a unit you receive for repair, do not honor the service warranty on the system.





## **Jumper Location J28**

Jumper location J28 controls which power supply the Power Macintosh G3 logic board can accommodate. When you receive a Power Macintosh G3 logic board from Service, you need to place the jumper in the proper location. The power supply used in the Power Macintosh G3 all-in-one computer is different from the power supply used in the G3 Minitower and G3 Desktop computer.

When replacing the logic board, be sure to check the power supply jumper setting. If this jumper is missing or set incorrectly for the computer model, the computer will not boot up





## I/O Cards

Power Macintosh G3 computers require an I/O card that moves audio and/or video from the main logic board. These cards are placed in the PERCH connector on the main logic board. If the card is not seated correctly, different symptoms appear. Look in the Symptom Charts for details on troubleshooting these cards.

**Note:** the Power Macintosh G3 computers will boot up without the I/O card installed, but they will not operate properly.





## Cleaning Procedure for Card Connectors

It is possible for residue to build up on the gold edge connector pins on some PCI cards, which could cause a variety of symptoms.

If you are having problems with a PCI card, inspect the connector pins with a magnifying glass. If you find residue, use a pencil eraser to gently clean the pins.







# Symptom Charts

## System

Fan is running, but no startup chime, screen is black, drive not accessed at startup, and no LED on front of system

- 1 Check jumper block J28. Be sure setting is correct for type of power supply installed (see “Logic Board” in Take-Apart chapter for more information).
- 2 Check jumper block configuration at J16. Make sure jumper block is correct color for processor type installed (see “Processor Module” in Take-Apart chapter for more information).
- 3 Reseat processor module. Make sure locking arm is in down position.
- 4 Reseat ROM DIMM.
- 5 Replace voltage regulator.
- 6 Replace logic board.
- 7 Replace processor module.





Fan is running, LED is on, drive is accessed at startup, but no startup chime and screen is black

- 1 Check jumper block J28. Make sure setting is correct for type of power supply installed (see “Logic Board” in Take-Apart chapter for more information).
- 2 Reseat ROM DIMM.

No apparent power, fan isn't running, no LED

- 1 Verify power cord is attached securely at both ends.
- 2 Check internal power cables and verify they are attached securely.
- 3 Reseat ROM DIMM and processor module. The logic board must have both a ROM DIMM and processor module installed to operate.
- 4 Reset Cuda chip. (Refer to “The Cuda Chip” in Basics chapter for instructions.)
- 5 Reset logic board. (Refer to “Resetting the Logic Board” in Basics chapter for instructions.)
- 6 Check jumper block J28. Make sure setting is correct for type of power supply installed (see “Logic Board” in Take-





Apart chapter for more information).

- 7 Check jumper block configuration at J16. Make sure jumper block is correct color for processor type installed (see “Processor Module” in Take-Apart chapter for more information).
- 8 Replace power cord.
- 9 Replace voltage regulator.
- 10 Replace power supply.
- 11 Replace logic board.
- 12 Replace processor module.

Clicking, chirping,  
thumping, or rubbing

- 1 Remove all PCI cards and test unit. If problem does not occur with cards removed, begin replacing cards one at a time to determine which card is causing problem. Replace problem card with known-good card.
- 2 Remove hard drive. If problem no longer occurs, replace hard drive with a known-good drive.
- 3 Replace power supply.





System shuts down  
intermittently

- 4 Replace processor module.
  - 5 Replace logic board.
  - 6 Replace floppy drive cable.
  - 7 Replace floppy drive.
  - 8 Replace I/O card.
- 
- 1 Make sure air vents are clear. Thermal protection circuitry may shut down system. After 30 to 40 minutes, system should be OK.
  - 2 Make sure power cord is plugged in firmly.
  - 3 Replace power cord.
  - 4 Check battery.
  - 5 Reset Cuda chip. (Refer to “The Cuda Chip” in Basics chapter for instructions.)
  - 6 Reset logic board. (Refer to “Resetting the Logic Board” in Basics chapter for instructions.)
  - 7 Replace power supply.
  - 8 Replace logic board.





System  
intermittently  
crashes or hangs

- 9 Replace processor module.
- 1 Verify system software is version 8.1 with enabler.
- 2 Verify software is known-good. Do a clean install of system software.
- 3 Verify software is Power Macintosh compatible (contact developer). Also, try booting with extensions off to determine if there are system init problems.
- 4 Clear parameter RAM. Hold down <Command> <Option> <P> <R> during startup but before "Welcome to Macintosh" appears.
- 5 Remove all SDRAM DIMMs and try replacing them one at a time to test. Replace any bad DIMMs.
- 6 Replace logic board.
- 7 Replace processor module.





During startup, following message is displayed, "This startup disk will not work on this Macintosh model...."

- 1 Verify startup disk is good.
- 2 Verify system software is version 8.1 with enabler.
- 3 Do a clean install of system software.





## Error Chords

One-part error chord sounds during startup sequence

- 1 Disconnect IDE data cable from hard drive and reboot system. If startup sequence is normal, initialize hard drive. Test unit again with IDE data cable connected. If error chord still sounds, replace hard drive.
- 2 Disconnect floppy drive cable from floppy drive and reboot system. If startup sequence is normal, replace floppy drive.
- 3 Reseat processor module.
- 4 Replace logic board.
- 5 Replace processor module.

Eight-part error chord (death chimes) sounds during startup sequence

- 1 Replace SDRAM DIMMs one at a time to test SDRAM. Replace any faulty DIMMs.
- 2 Replace logic board.





## Video

Screen is black, but boot tone is present, drive operates, fan is running, and LED is lit

- 1 Adjust brightness on monitor.
- 2 Clear parameter RAM. Hold down <Command> <Option> <P> <R> during startup but before "Welcome to Macintosh" appears.
- 3 Reset Cuda chip. (Refer to "The Cuda Chip" in Basics chapter for instructions.)
- 4 Reset logic board. (Refer to "Resetting the Logic Board" in Basics chapter for instructions.)
- 5 Check cable connections on analog and CRT video board.
- 6 Check that P505 connects to P913 **and** P905 on the power supply board.
- 7 Check that P507 connects to P908 on the power supply.
- 8 Replace RGB monitor cable.
- 9 Remove all SDRAM DIMMs and try replacing them one at a time to test. Replace any bad DIMMs.
- 10 Replace logic board.







Screen is black, no boot tone and drive does not operate, but fan is running and LED is lit

- 1 1 Replace processor module.
- 1 Reset Cuda chip. (Refer to “The Cuda Chip” in Basics chapter for instructions.)
- 2 Reset logic board. (Refer to “Resetting the Logic Board” in Basics chapter for instructions.)
- 3 Remove all SDRAM DIMMs and try replacing them one at a time to test. Replace any bad DIMMs.
- 4 Check cable connections on analog and CRT video board.
- 5 Check that P505 connects to P913 **and** P905 on the power supply board.
- 6 Check that P507 connects to P908 on the power supply.
- 7 Replace RGB monitor cable.
- 8 Replace logic board.
- 9 Replace power supply.
- 10 Replace processor module.





Boot tone is present and screen lights up, but nothing is displayed on screen

- 1 Reset Cuda chip. (Refer to “The Cuda Chip” in Basics chapter for instructions.)
- 2 Reset logic board. (Refer to “Resetting the Logic Board” in Basics chapter for instructions.)
- 3 Check cable connection on analog and CRT video board.
- 4 Check that P505 connects to P913 **and** P905 on the power supply board.
- 5 Check that P507 connects to P908 on the power supply.
- 6 Replace RGB video cable.
- 7 Replace logic board.
- 8 Replace processor module.





## Floppy Drive

Internal floppy drive does not operate

- 1 Replace floppy disk with known-good disk.
- 2 Replace floppy drive cable.
- 3 Replace floppy drive.
- 4 Replace logic board.
- 5 Replace processor module.

During system startup, disk ejects; display shows icon with blinking "X"

- 1 Replace disk with known-good system disk.
- 2 Replace floppy drive cable.
- 3 Replace floppy drive.
- 4 Replace logic board.
- 5 Replace processor module.

Disk does not eject

- 1 Switch off computer. Hold down mouse button while you switch computer on.
- 2 Replace floppy drive cable.
- 3 Replace floppy drive.





	<ol style="list-style-type: none"><li>4 Replace logic board.</li><li>5 Replace processor module.</li></ol>
Drive attempts to eject disk, but doesn't	<ol style="list-style-type: none"><li>1 Reseat floppy drive bezel and drive so bezel slot aligns correctly with drive.</li><li>2 Replace floppy drive.</li></ol>
Internal floppy drive runs continuously	<ol style="list-style-type: none"><li>1 Replace disk with known-good floppy disk.</li><li>2 Replace floppy drive cable.</li><li>3 Replace floppy drive.</li><li>4 Replace logic board.</li><li>5 Replace processor module.</li></ol>
MS-DOS drive does not recognize a disk formatted on a 1.4 MB drive	To read and write files with either MS-DOS or 1.4 MB drive, format all disks with MS-DOS drive first.





## Hard Drive

Single internal hard drive does not operate; drive doesn't spin

- 1 Replace hard drive power cable.
- 2 Replace hard drive. If problem resolved, reinstall IDE device driver and system software.
- 3 Replace power supply.

No internal SCSI drives operate

- 1 Verify there are no duplicate SCSI device addresses on a single SCSI bus.
- 2 Disconnect external SCSI devices and check for proper termination. Only last device in SCSI chain should be terminated.
- 3 Check internal SCSI devices for proper termination.
- 4 Replace internal SCSI data cable to which non-operational devices are attached.
- 5 Replace power supply.
- 6 Replace logic board.
- 7 Replace processor module.





Works with internal or external SCSI devices but not with both

- 1 Verify there are no duplicate SCSI device addresses
- 2 Replace terminator on external SCSI device.
- 3 Verify that SCSI device at end of internal SCSI data cable is only device terminated.
- 4 Refer to appropriate manual to troubleshoot defective external device.





## Peripherals

Cursor does not move

- 1 Check mouse connection.
- 2 Inspect inside of mouse for buildup of dirt or other contaminants. Clean mouse if necessary.
- 3 If mouse was connected to keyboard, connect mouse to computer ADB port instead. If mouse works, replace keyboard.
- 4 Replace ADB cable.
- 5 If mouse does not work in any ADB port on computer, replace mouse.
- 6 Replace logic board.
- 7 Replace processor module.

Cursor moves, but clicking mouse button has no effect

- 1 Boot from floppy or bootable CD.
- 2 Replace mouse.
- 3 Replace logic board.





Double-click doesn't open application, disk, or server

- 1 Remove duplicate system folders.
- 2 Clear parameter RAM. Hold down <Command> <Option> <P> <R> during startup but before "Welcome to Macintosh" appears.
- 3 If mouse was connected to keyboard, connect mouse to computer ADB port instead. If mouse works, replace keyboard.
- 4 If mouse does not work in any ADB port on computer, replace mouse.
- 5 Replace logic board. Retain customer's DIMMs.

No response to any key on keyboard

- 1 Check keyboard connection to ADB port.
- 2 Replace keyboard cable.
- 3 Replace keyboard.
- 4 Replace logic board.







Known-good serial printer does not work

- 1 Verify you have correct version of system software.
- 2 Verify that Chooser is set correctly.
- 3 Reinstall correct printer drivers.
- 4 Do clean install of system software.
- 5 Replace printer interface cable.
- 6 Replace logic board. Retain customer's DIMMs.

Known-good network printer does not print

- 1 Check network connections.
- 2 Verify you have correct version of system software.
- 3 Verify that Chooser is set correctly.
- 4 Does printer show up in Chooser? If so, do clean install of system software and/or network and printer software.
- 5 Replace logic board. Retain customer's DIMMs.





## CD-ROM Drive

CD-ROM drive does not work

- 1 Try using known-good compact disc.
- 2 Replace CD-ROM drive mechanism.

Macintosh does not display CD-ROM icon once CD is inserted in drive

- 1 Verify that CD-ROM software is installed.
- 2 Replace CD-ROM drive mechanism.
- 3 Replace CD-ROM data cable.





## Miscellaneous

No sound from speaker

- 1 Disconnect any microphones or external speakers.
- 2 Verify that volume setting in Control Panel is adequate and mute is not checked.
- 3 Clear parameter RAM. Hold down <Command> <Option> <P> <R> during startup but before "Welcome to Macintosh" appears. Verify speaker is plugged into logic board.
- 4 Plug headphones or external speakers into the external jack. If the the external jack works, replace the internal speaker or logic board. If the external jack doesn't work, proceed to the next step.
- 5 Replace I/O Audio card.
- 6 Replace speaker.
- 7 Replace logic board.



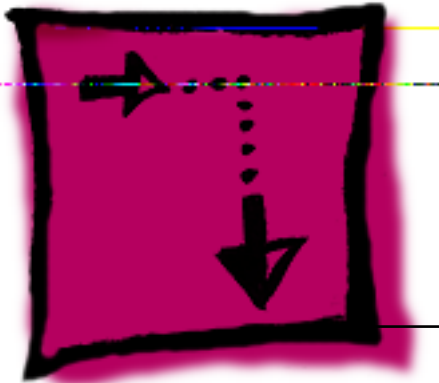

## Adjustments

Power Macintosh G3  
All-In-One





# Light Meter Setup

## Model L-248

**Note:** This topic covers setup for two light meters: Models L-248 and 246.

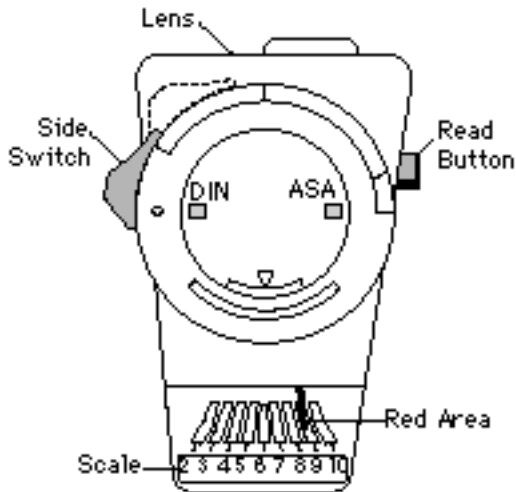

- 1 Press the red button on the back of the light meter to check the battery.
- 2 If the reading is out of the red area, replace the battery.
- 3 Move the side switch to its upper position so that





the scale reads 10 through 18.

- 4 Uncover the lens of the meter.
- 5 Place the lens against the middle of the screen and press the read button to read the scale.





## Model 246

This topic covers setup for light meter Model 246.



- 1 Remove the metal slide, if installed, from the top of the light meter.
- 2 Install the white lens with the red dot.
- 3 Rotate the lens of the meter to face the monitor.
- 4 Place the lens against the middle of the screen and read the scale.



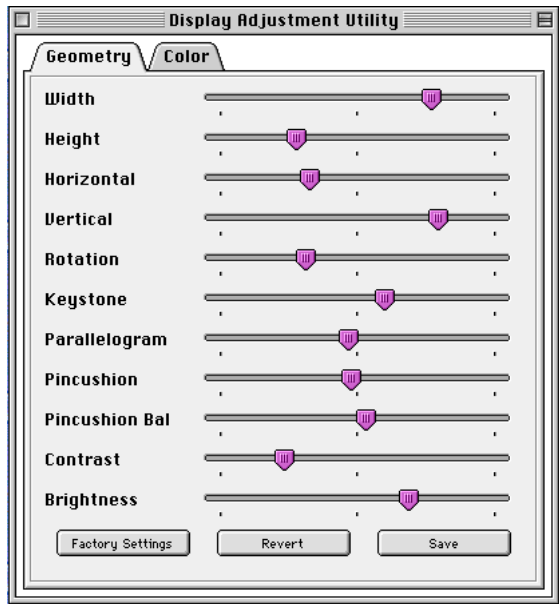

## Geometry

The Geometry adjustments shown are controlled via the Diagnostic Adjustment Utility.

- 1 Using the Diagnostic Adjustment Utility (DAU), adjust the settings by moving the appropriate slider bar.

Refer to the Read Me file later in this section for more information.

**Note:** Geometry adjustments are also accessible through the Monitors & Sound control panel.







## Using Monitors & Sound Control Panel

To use the Monitors & Sound control panel select Control Panels from the Apple menu, and select Monitors & Sound.

- 1 Click the Monitor button.
- 2 Drag the slider controls left or right to decrease or increase settings.





## Video

Use the Display Adjustment Utility (DAU) and the Display Service Utility (DSU) to perform the following adjustments.



DAU

Run  
Display Service  
Utility



Refer to the Read Me file later in this section for more information.

**Replacement Note:** Perform the cutoff adjustment whenever you replace the CRT, the analog /video board, or whenever the screen control has been inadvertently changed.





## Cutoff

**Note:** Perform the cutoff adjustment prior to adjusting the white balance

Perform the cutoff and white balance adjustments after the monitor has been on for at least 10 minutes.

- 1 Using the Diagnostic Adjustment Utility, set the contrast slider control to the maximum setting and the brightness slider control to its minimum (far left) position.

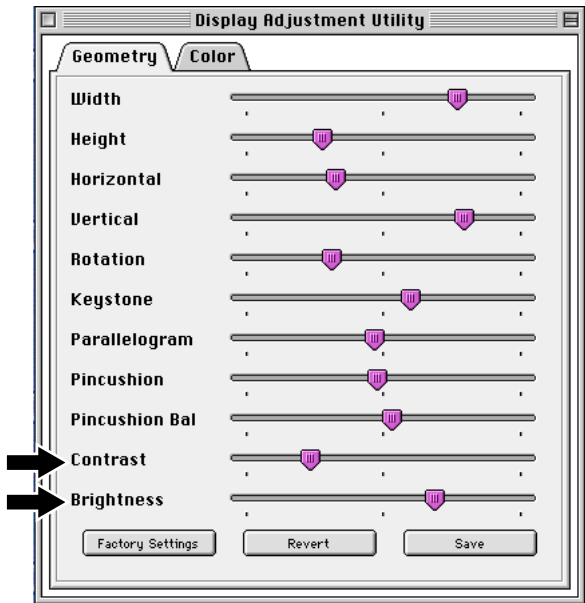

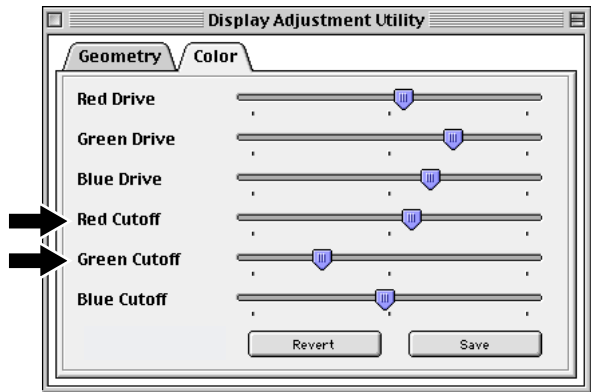

- Using the Diagnostic Adjustment Utility (Color section), set the green and red drive slider control to the minimum positions.

**Note:** You will need to switch between the Display Service Utility's gray bars test pattern and the color section of the Diagnostic Adjustment Utility in order to make this adjustment.





Run  
Display Service  
Utility



Gray Bar  
Test Pattern

- 3 **Note:** Verify that the display resolution is set to 640 x 480.

Run Display Service Utility to display the Gray Bars test pattern.



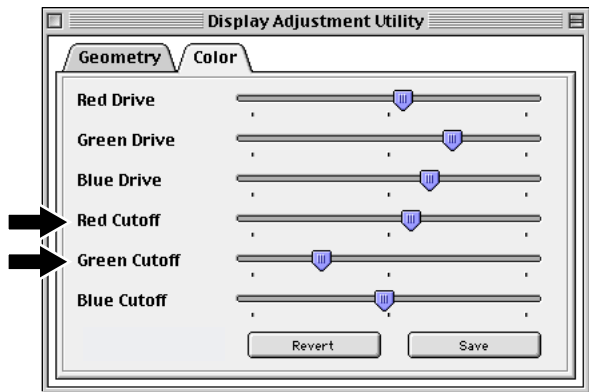

- Using the Diagnostic Adjustment Utility (DAU) Color section, set the red cutoff slider control and the green cutoff slider control to their minimum positions.





- 5 Using the Diagnostic Adjustment Utility (Geometry Section), adjust the brightness slider control very slowly, switching back to the Gray Bars test pattern to check the results, until the third darkest bar from the left is just faintly visible.

**Note:** The screen control is now set correctly and shouldn't have to be readjusted unless inadvertently altered.

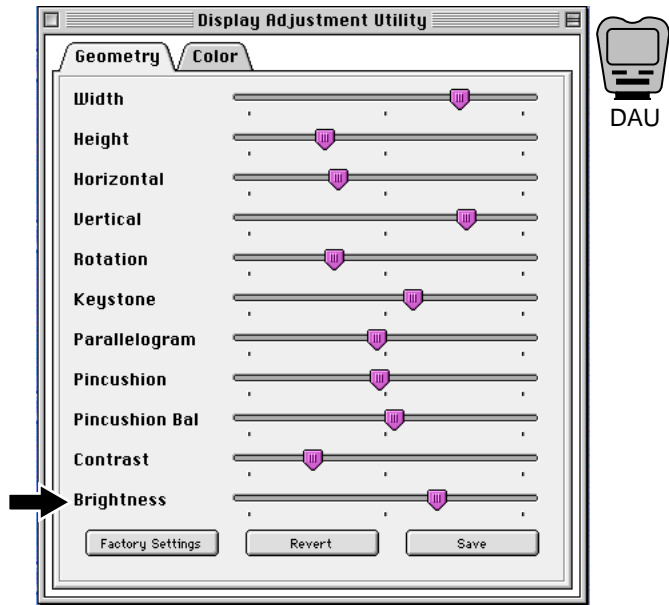



Run  
Display Service  
Utility



Gray Bar  
Test Pattern

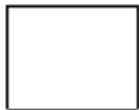

ATI-White Screen

## White Balance

**Note:** Perform the white balance adjustments after the monitor has been on for at least 10 minutes and the cutoff procedure has just been completed.

- 1 **Note:** Verify that the display resolution is set to 640 x 480.

Run Display Service Utility to display the Gray Bars test pattern.





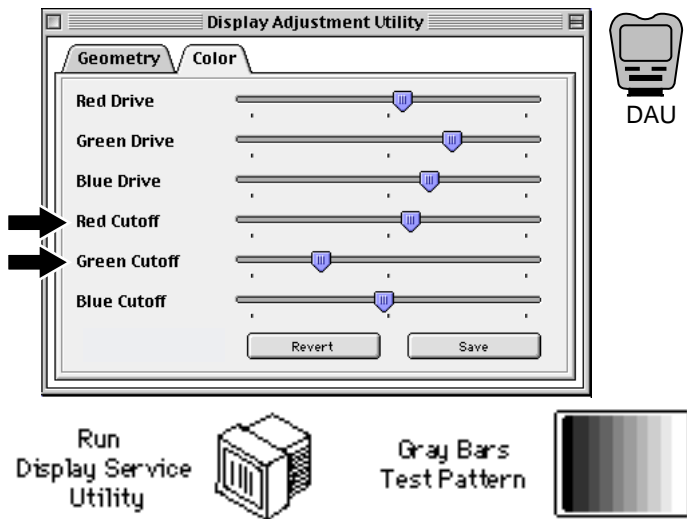

- Using the Diagnostic Adjustment Utility (Color Section), adjust the red and green cutoff slider controls to neutralize the four darkest bars.

**Note:** You will need to switch between the Display Service Utility's gray bars test pattern and the color section of the Diagnostic Adjustment Utility in order to make this adjustment.





Run Display Service Utility

Gray Bars Test Pattern

- 3 If the screen shows a predominant blue color, start by adjusting the green cutoff slider control until the blue color is neutralized with green, and it's difficult to tell whether the four darkest bars are blue or green.
- 4 Adjust the red cutoff slider control until the bars appear to be shades of gray.

**Note:** If the predominant color appears to be always too red or too green, reduce





the levels of both the green and red cutoff slider controls to neutralize the predominant color. The darkest bar must remain completely black, and the second darkest bar should be just barely visible.

**Caution:** Be careful when performing color adjustments. There is no pre-defined factory setting for color



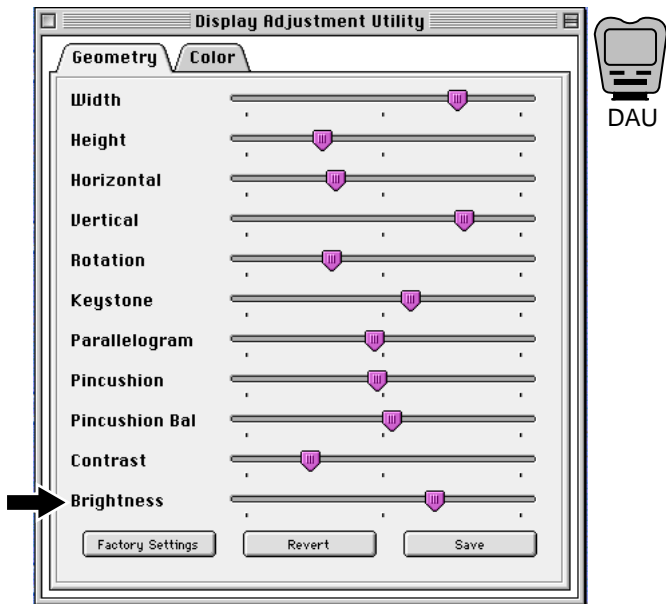

- 5 Using the Diagnostic Adjustment Utility (Geometry Section), Set the Brightness slider control to its center position.

**Note:** The screen might appear too bright and out of focus.





Run  
Display Service  
Utility

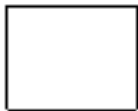

All-White Screen

- 6 Run the Display Service Utility to display the All-White screen test pattern.
- 7 Hold a light meter or photometer against the center of the screen.



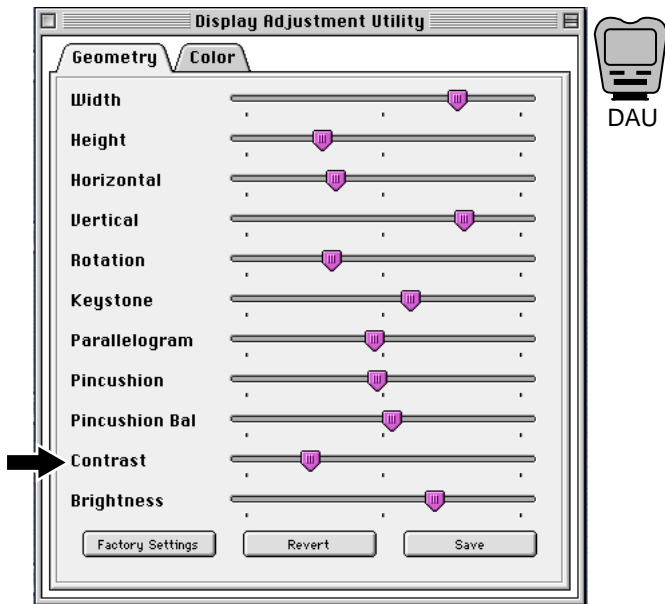

- 8 Using the Display Adjustment Utility, adjust the contrast slider control to decrease the screen brightness until the screen luminance measures
- Upper end of 10 on the 10 through 18 scale of light meter Model L-248
  - 21 foot candles on the red scale of light meter Model 246
  - 25 fL (foot lamberts) on a photometer





Run  
Display Service  
Utility



Gray Bar  
Test Pattern

- 9 Run the Display Service Utility to display the Gray Bars test pattern.
- 10 In most cases the four brightest bars will appear to be shades of gray, and the lifetimes bar will be solid black. If not, using the Diagnostic Adjustment Utility, adjust the red and green drive controls until the color of the four brightest bars is neutralized.





- 11 Check the screen luminance again and reset it to the proper reading by repeating the previous step that set it to one of the following:
- Upper end of 10 on light meter Model L-248
  - 21 foot candles on light meter Model 246
  - 25 fL (foot lamberts) on a photometer







## Read Me File–Display Adjustment Utility, v. 1.0

Use the Display Adjustment Utility to adjust the geometry, brightness, contrast, and color of Power Macintosh G3 All-in-one displays. The utility is designed to run on Power Macintosh G3 All-in-one computers under Mac OS 8.1. The READ Me file and the Display Adjustment Utility can be found on the Service Source Companion 2 CD.

**Note:** When running this utility, QuickTime™ v2.5 (or later) extension and QuickTime™ PowerPlug v2.5 (or later) extension must be enabled.





## Geometry Adjustments

- Save button - Clicking this button saves the adjustments you have performed.

**Note:** Adjustments (except for brightness and contrast) are linked to the resolution that the display is currently using. If the user changes the resolution, the adjustments will not apply to the new resolution.

- Revert button- Clicking this button restores the display to the last set of adjustments.

**Note:** Once you save a set of adjustments, you cannot revert to a previous set of adjustments.





- Factory Setting button - Clicking this button sets the adjustments to pre-defined factory settings.

**Note:** Brightness and Contrast adjustments will not be affected by clicking the "Factory Setting" button. There is no pre-defined factory setting for brightness and contrast.

**Caution:** Do not turn brightness and contrast all the way down. If you do, you may not be able to see the controls clearly enough to readjust them.





## Color Adjustments

- Save - Clicking this button saves the adjustments.
- Revert - Clicking this button restores the display to the last set of adjustments.

**Note:** Once you save a set of adjustments, you cannot revert to a previous set of adjustments.

**Caution:** Be careful when performing color adjustments. There is no pre-defined factory setting for color.





## Upgrades

Power Macintosh G3

All-In-One





## PCI or I/O Cards

Before you begin, remove the chassis carrier.

- 1 Remove the screw that holds the port access cover in place.
- 2 Remove the port access cover.

**Note:** If you remove all three port access covers, be sure the sheet metal shield remains under the edge of the logic board.

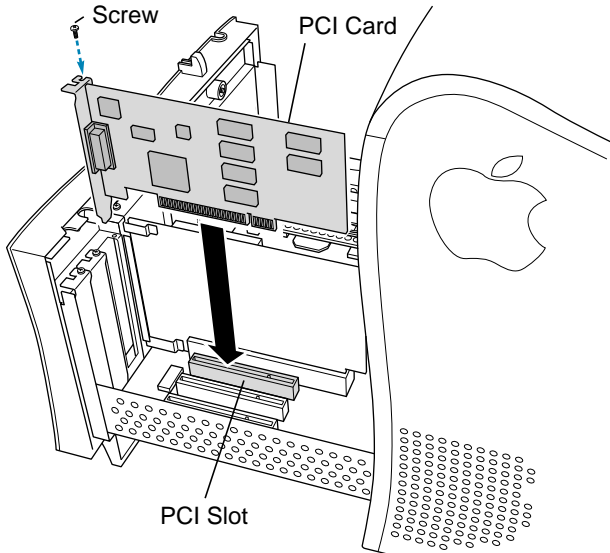

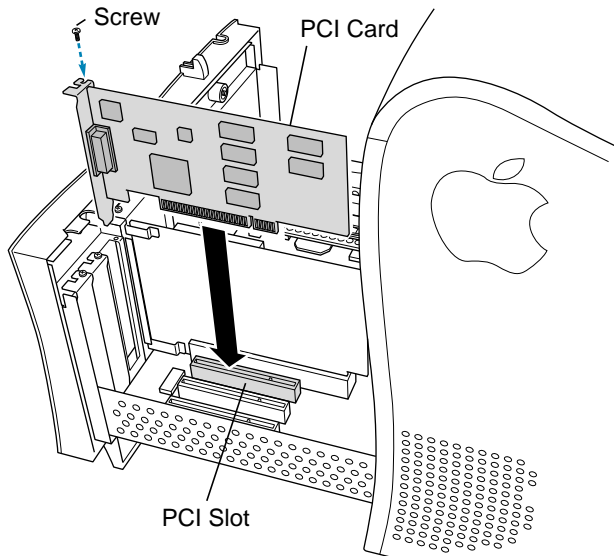

- 3 Align the card connector with the expansion slot and press straight down until the connector inserts all the way into the slot.





## Memory—DRAM or VRAM

Before you begin, remove the

- Chassis carrier
- Cable clamp support bracket

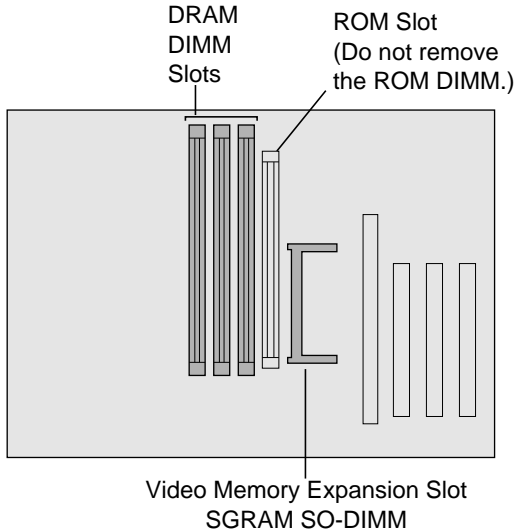





## DRAM

**Note:** DIMM shape and components may vary.

- 1 To remove existing DRAM DIMMs to make room for new ones, push down on the ejectors.

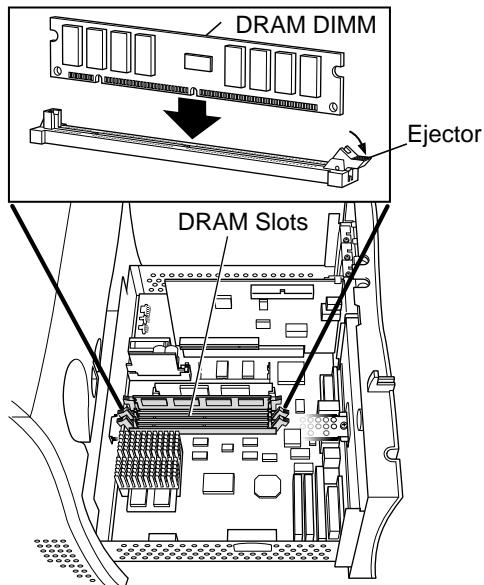

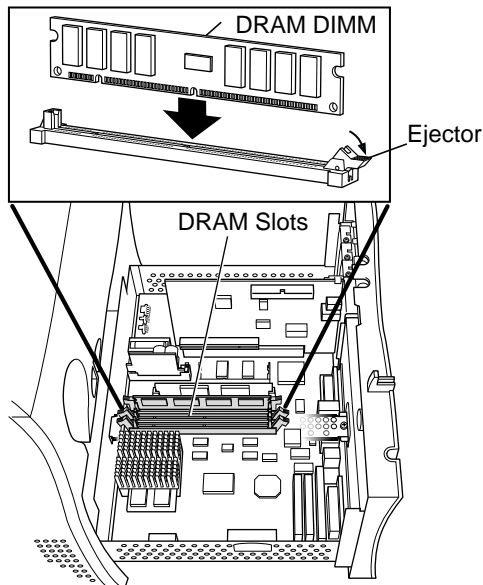

- 2 Align DIMM notches with DRAM slot ribs.

**Note:** The DIMM is designed to fit in the slot only one way.

- 3 With ejectors open, press the DIMM into the slot.

**Note:** Slot may have one or two ejectors.





## VRAM

**Note:** SGRAM DIMM shape and components may vary.

- 1 To remove existing SGRAM DIMM, spread arms of video memory slot apart slightly. The SGRAM DIMM will pop up.

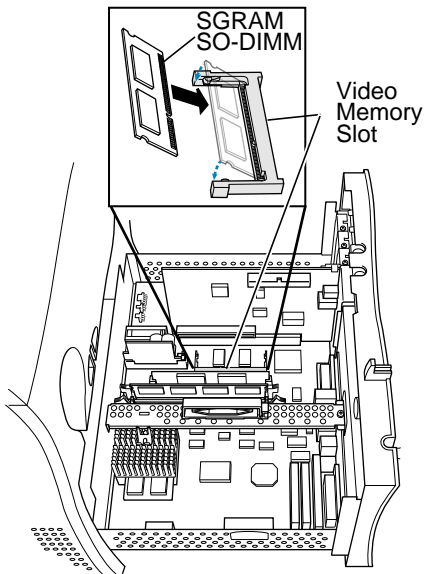



## Additional Procedures

---

Power Macintosh G3  
All-in-One





## Adding a Zip Drive

There may be requests to add a zip drive to a Power Mac G3 All-in-one computer. Some prebuilt and build-to-order configurations do not include a zip drive. Therefore, customers may want to upgrade their systems by installing a zip drive taken from another computer, or by purchasing the individual service parts.

**Note:** If a customer wants a zip drive from another computer installed in their All-in-one, make sure to remove any cables and mounting brackets, and make sure to install the All-in-one EMI shield (part number 922-3525). The zip drive cables are already in place and ready to use.

See the following pages for instructions.



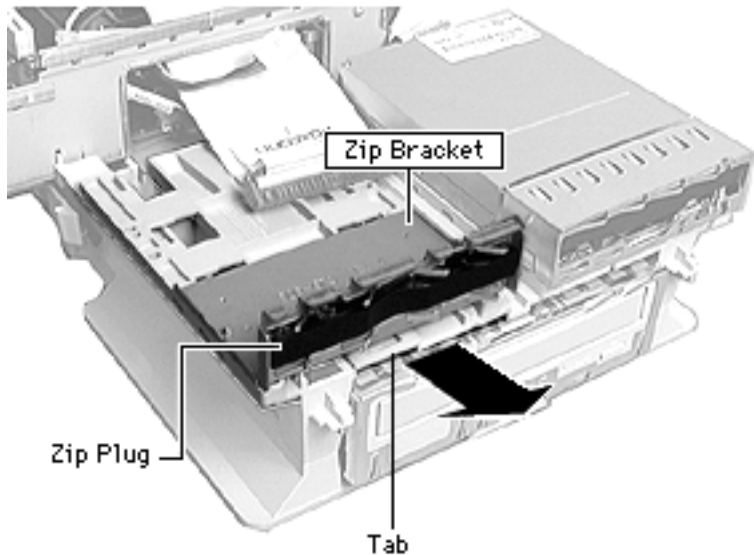

Before you begin, remove the chassis carrier (see the Take-Apart procedures).

- 1 Pull up on the release tab and remove the Zip drive carrier from the unit.

**Note:** When there is no Zip drive installed, the carrier has a Zip plug and Zip bracket attached to the carrier. You must remove these to install a Zip drive.



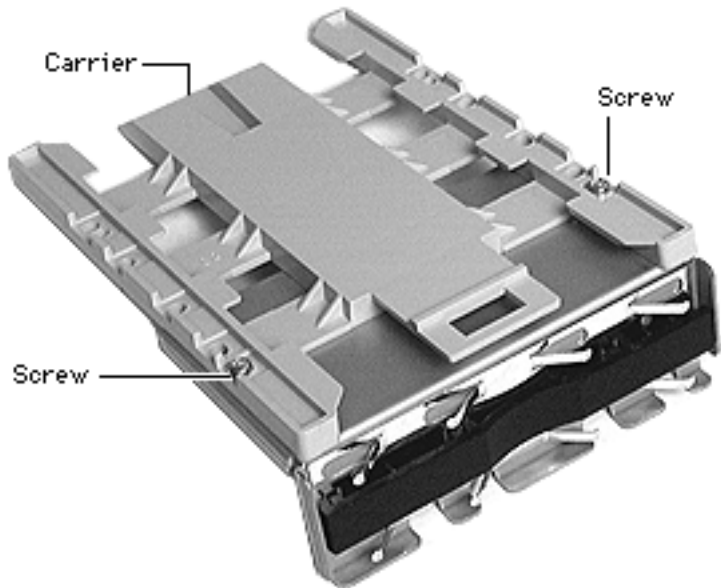

- 2 Flip the carrier over and remove the two screws that hold the Zip bracket on the carrier.
- 3 Screw the zip drive to the carrier, slide the carrier into place, and connect the cables.
- 4 Attach the zip EMI shield, part number 922-3525.
- 5 Replace chassis carrier.
- 6 Connect remaining internal cables, power on, and test the unit.





## Exploded View

Power Macintosh G3  
All-In-One





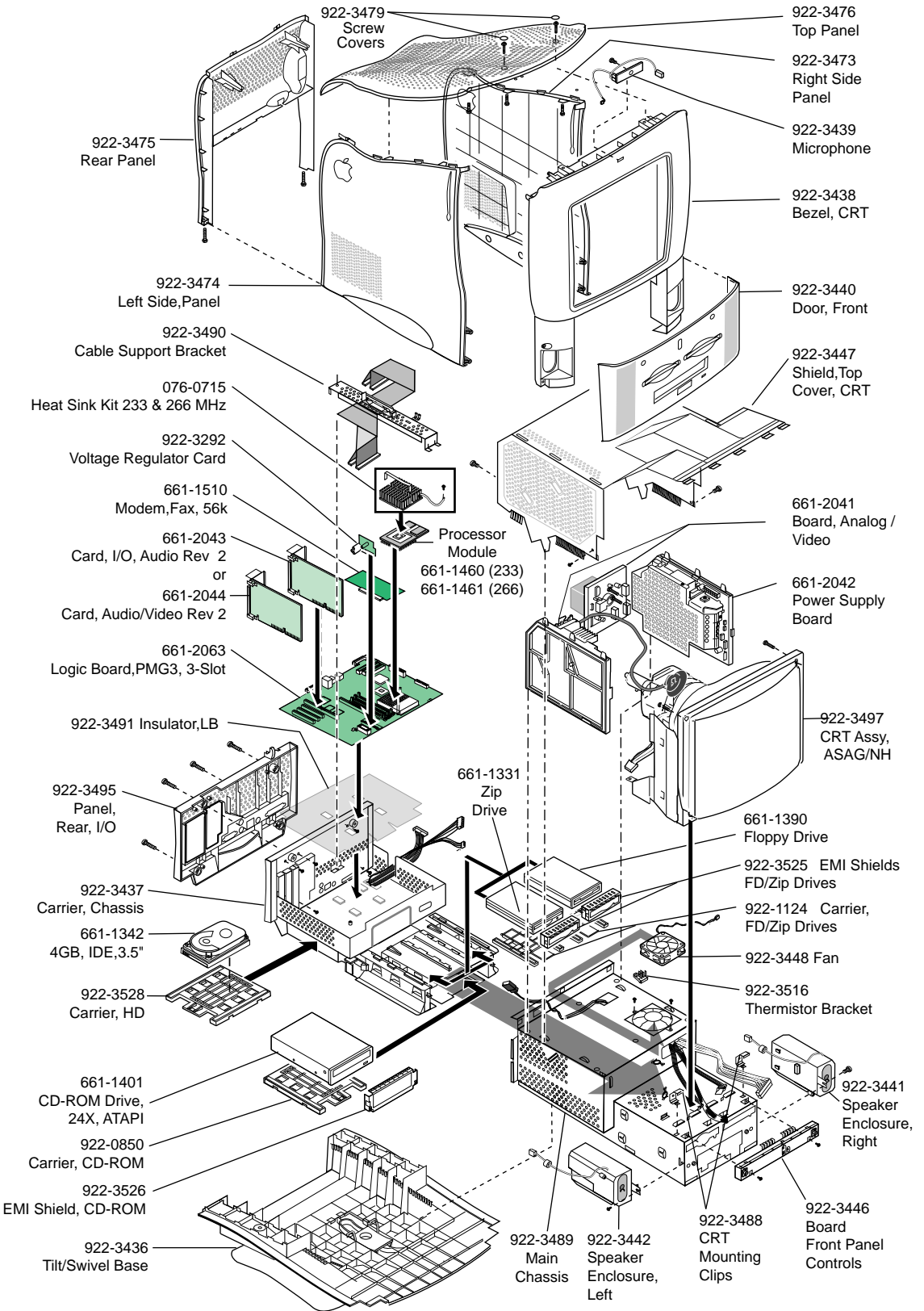

Note: for cable see G3 EV 2, and screw Identification see EV Screw Matrix





# Cables Exploded View

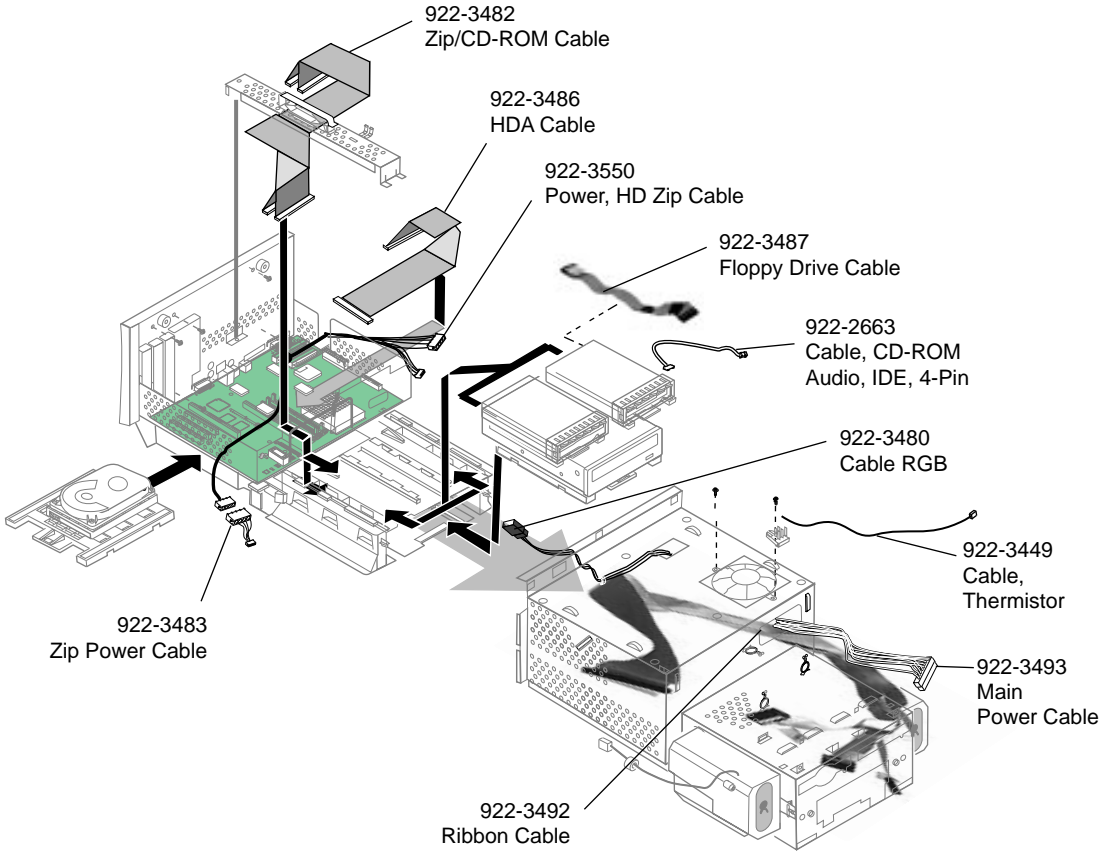

**Power Macintosh G3 (All-in-One) EV 2- Carrier Chassis & Main Chassis Cables**





# Screw Matrix Exploded View

**SCALE 1"=1"**

**Power Macintosh G3 (All-in-One) Screw Matrix**

- (922-3538) Housing Panel Screws (10)
- (922-3546) I/O Door (Bottom Drawer) (2)
- (922-3542) CRT Bezel front(4), Top Housing (2), CRT Metal Frame to Bezel (4)
- (922-1382) Carrier for Floppy/Zip Screws (4 per device), Zip Plug & shield -if installed (2)
- (922-3544) Fan (2)
- (922-3537) I/O Plastic Panel (from inside) to Metal Chassis (5)
- (922-3259) I/O Card on Exterior (1), Cable Support Bracket (1), I/O Card to Chassis (2), Logic Board (2)
- (922-3543) CRT Clips (2), EMI Shield (5), Back of CRT (2), PCI Covers (3)
- (922-3540) Thermistor Bracket (1)
- (922-3539) Front Panel Board (2), Speakers, (2)
- (922-3541) Microphone (1)
- (922-3536) Tilt Swivel Base (2)

