



PowerBook G4 (17-inch)

17 March 2003



Take Apart
PowerBook G4 (17-inch)



General Information



Overview

Some key features that distinguish this computer from earlier PowerBook models include:

- 17-inch TFT widescreen display in aluminum alloy enclosure
- Built-in Bluetooth
- Built-in AirPort Extreme card
- Added FireWire 800 port
- Uses double-data rate (DDR) memory
- Fiber optic backlit keyboard with ambient light sensor

New Procedures

If you are familiar with taking apart notebook computers, you will notice some differences with this model:

- The keyboard is secured with screws accessible from under the top case.
- Memory cards are easily accessible from the bottom of the computer.
- The AirPort Extreme card is not user replaceable.
- The quantity and types of screws differ from earlier models.

Important Notes

- Memory from previous PowerBook models is not compatible with this computer. Do not use older SDRAM DIMMs or SDIMMs even if they fit into the slot.
- The Bluetooth module is different from the PowerBook G4 (12-inch).
- The AirPort Extreme card assembly has a flex cable glued to the card, making it unique and specific to this computer.

Tools

The following tools are recommended for the take apart procedures.

- ESD wrist strap and mat
- Soft cloth
- #00 Phillips screwdriver (magnetized)
- #0 Phillips screwdriver (magnetized)
- #1 Phillips screwdriver (magnetized)
- 4 mm socket wrench
- Needlenose pliers
- Torx T6 screwdriver
- Torx T8 screwdriver
- Black stick (nylon probe tool 922-5065) (or other nonconductive nylon or plastic flat-blade tool)
- X-Acto® knife with straight edge blade
- Multi-compartment screw tray (such as a plastic ice cube tray)
- Kapton® tape
- Voltmeter (for troubleshooting)
- Small low-power magnet (for troubleshooting)
- Apple Pro keyboard and mouse (for troubleshooting)

Serial Number Location

The serial number is located in the battery bay.

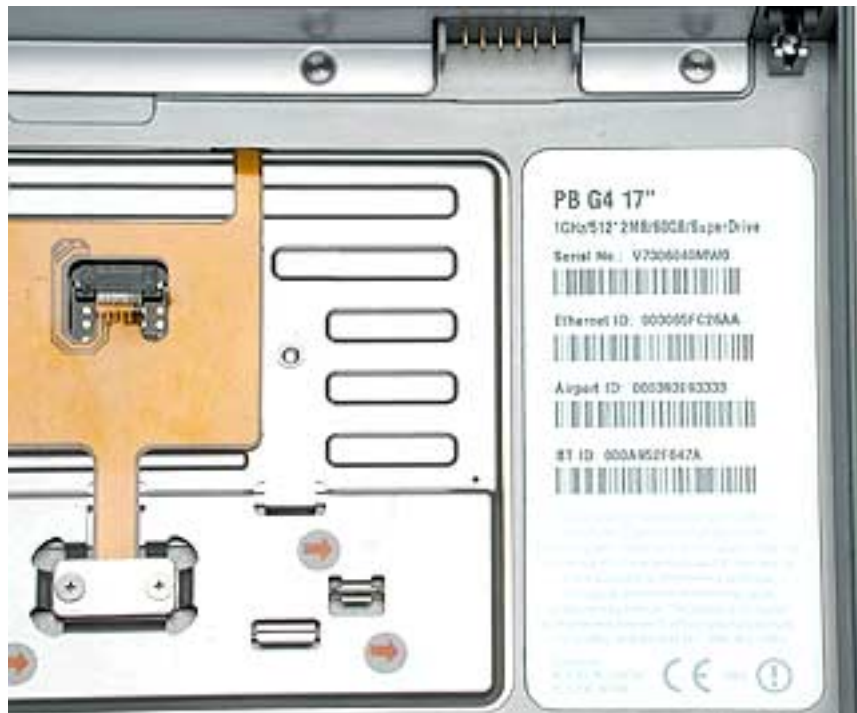

Zero Insertion Force Connectors

Zero insertion force (ZIF) connectors are used in several locations in the computer.

Important: The locking bar on the ZIF connector is extremely fragile and is not intended to separate from the connector. When releasing a bar, use extreme care and a restrained light pressure to move the bar only slightly.

Warning: If a locking bar breaks, you will need to replace the board.

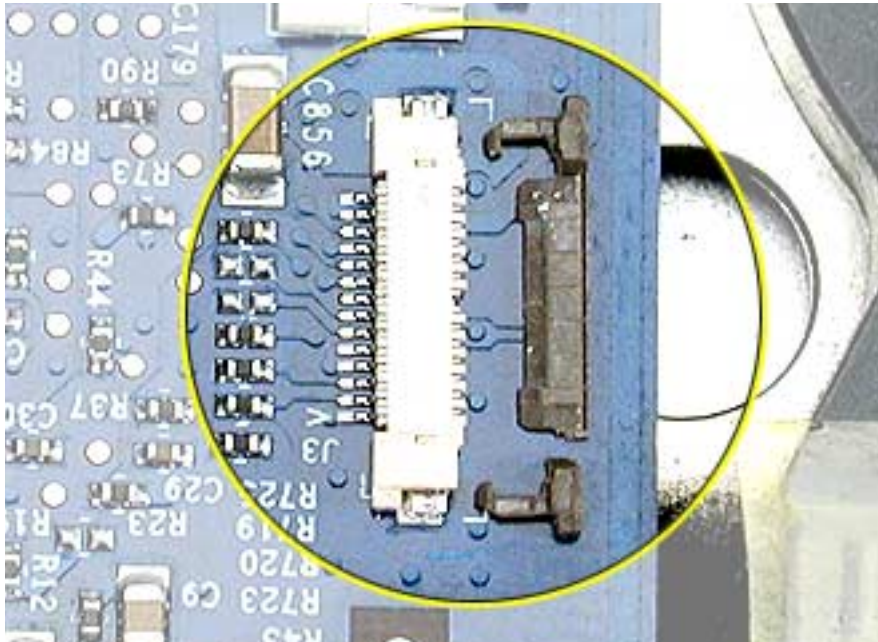

To release the flex cable

Use a flat-blade tool to move the bar on both sides.

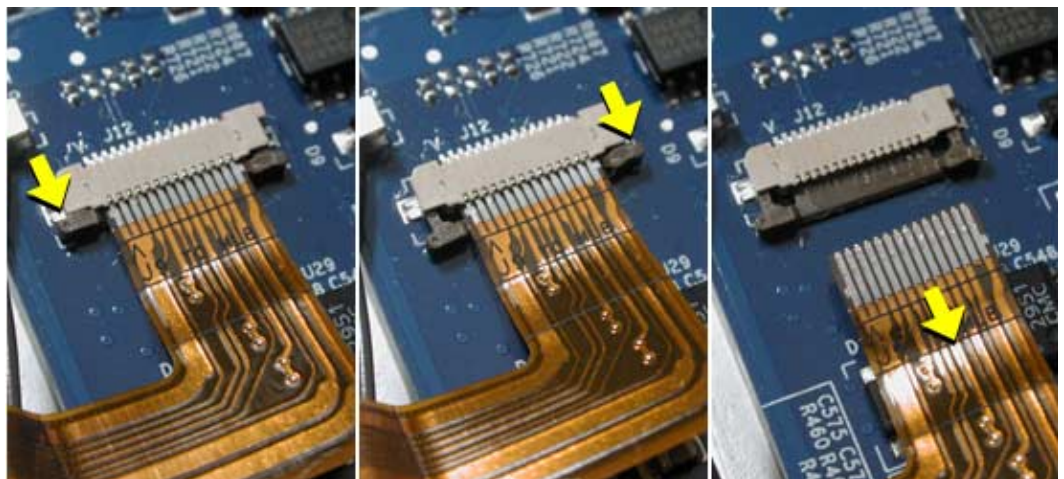

To connect a flex cable

Make sure the locking bar is released, then slide the end of the flex cable all the way into the connector. Hold the cable in place, then slide the locking bar into the connector on both sides to secure.

Important: Verify that the cable is straight. Use either the alignment mark, if present, or the metal edge on the cable as a guide to ensure the cable is straight.

Warning: If the flex cable is inserted crooked, some signals may not be connected or signals may short together (a bad connection is shown below.)

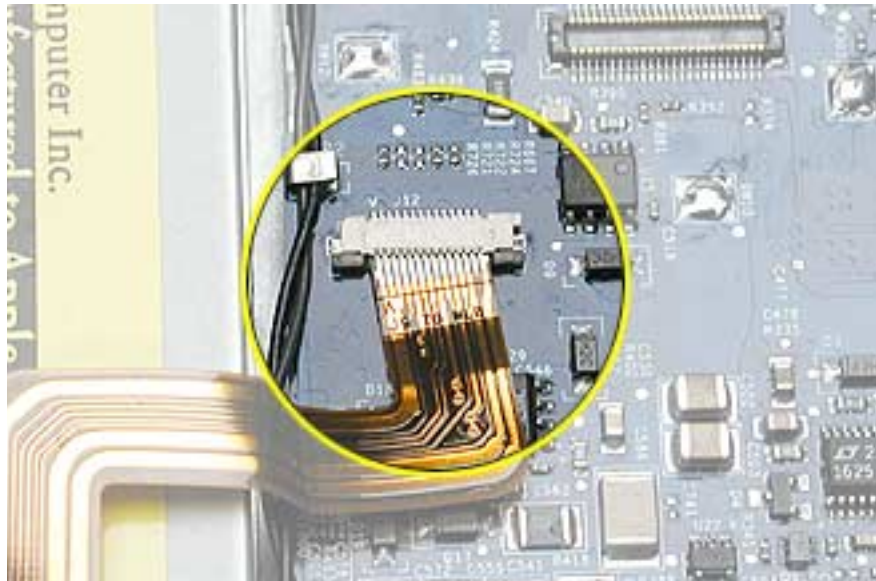

Note: If a cable is not securing properly, verify that it is inserted on the correct side of the locking bar.



Battery

Tools

This procedure requires the following tools:

- Soft cloth

Part Location

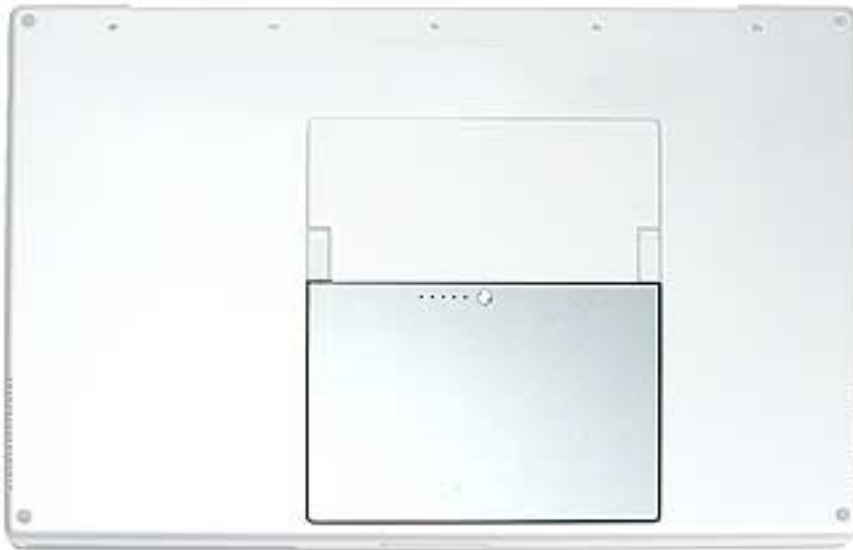

Preliminary Steps

Warning: Always shut down the computer before opening it to avoid damaging its internal components or causing injury. After you shut down the computer, the internal components can be very hot. Let the computer cool down before continuing.

Procedure

Warning: If the computer has been recently operating, allow it to cool down before performing this procedure.

1. Shut down the computer.
2. Disconnect the power cord and any other cables connected to the computer.
3. Place the computer face down on a soft cloth.
4. Slide both battery latches away and lift the battery out of the battery bay.

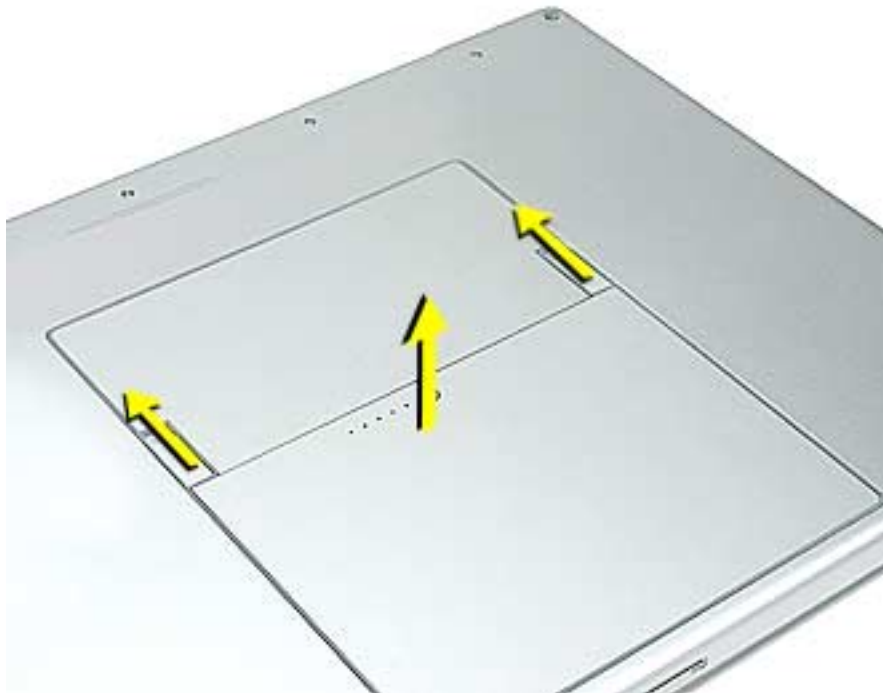



Memory Door and Memory Cards

Tools

This procedure requires the following tools:

- Soft cloth
- #0 Phillips screwdriver

Part Location



Preliminary Steps

Before you begin, remove the battery.

Procedure

Warning: If the computer has been recently operating, allow it to cool down before performing this procedure.

1. Place the computer face down on a soft cloth.
2. Remove the three screws from the memory door.

Note: Check for lost screws caught by magnets inside the front edge of the battery well.

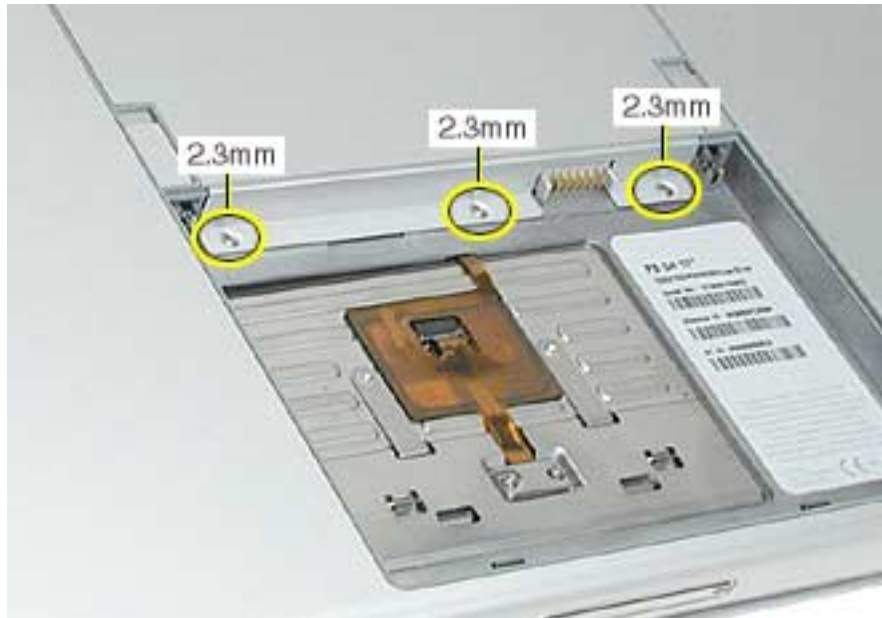

3. Lift the memory door up slightly and slide it straight back to remove.



Note: If only one memory card is installed, it's factory installed in the top memory slot (nearest to outside edge of the computer).

4. To remove either memory card, first release it by spreading apart the tabs in the memory slot from the notches in the card until the card pops up slightly.

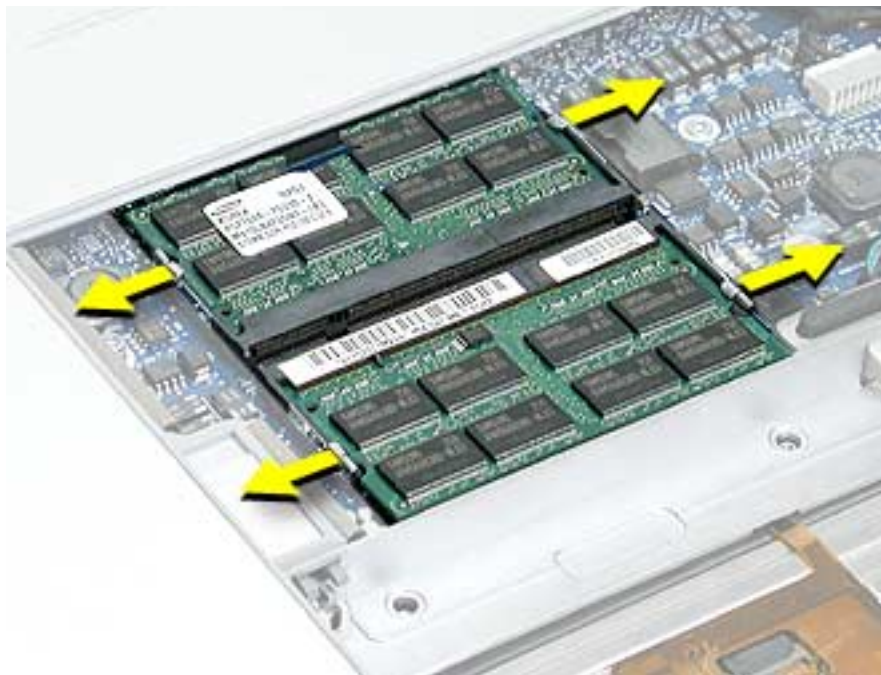

5. Pull the card straight out of the memory slot.

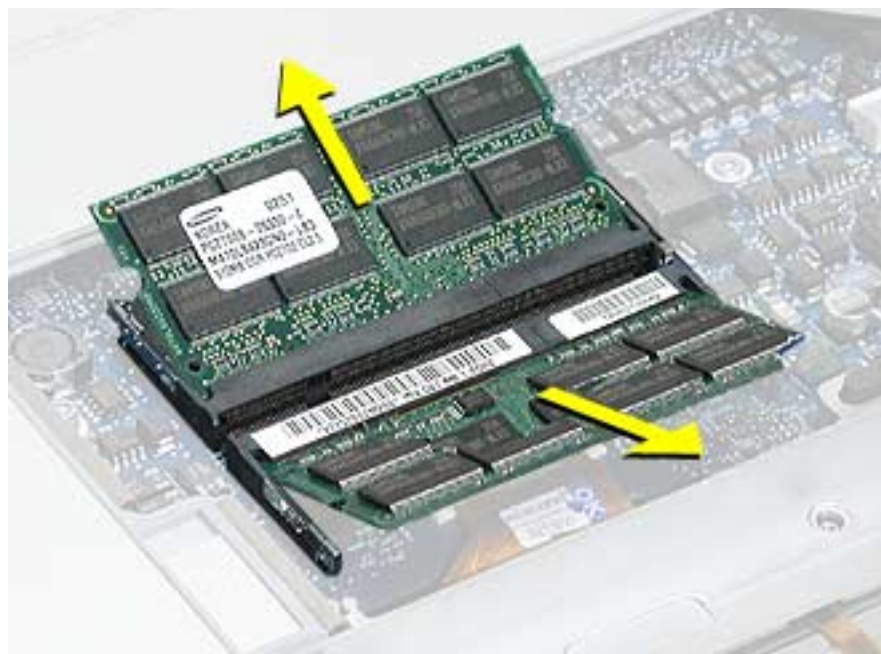

6. Align the notch in the board with the tab in the slot and insert the replacement memory cards at a 30-degree angle, pushing the card firmly until fully seated.

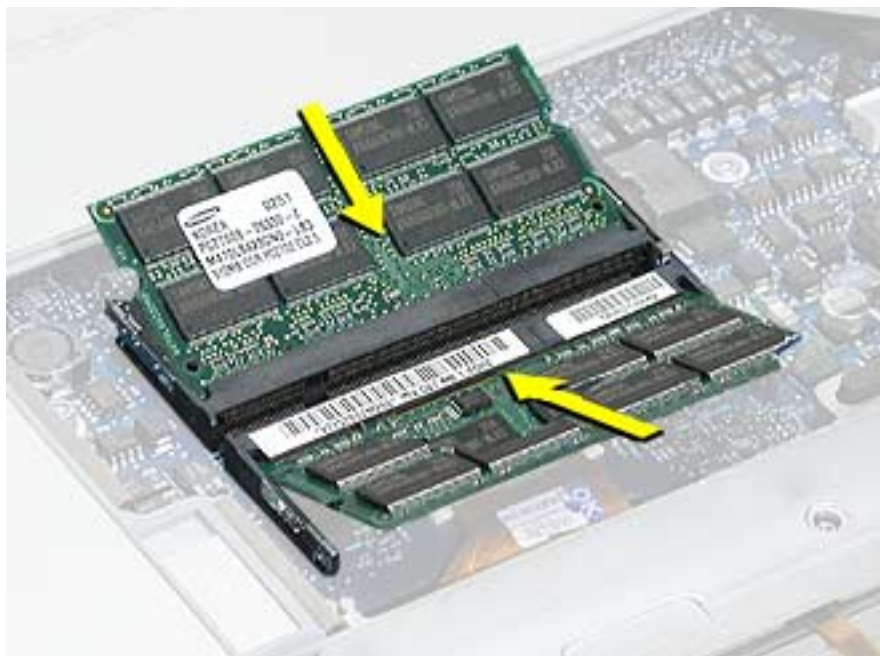

7. Check that the notches in the card clear the tabs as you press down on the sides of the card to lock it into place.

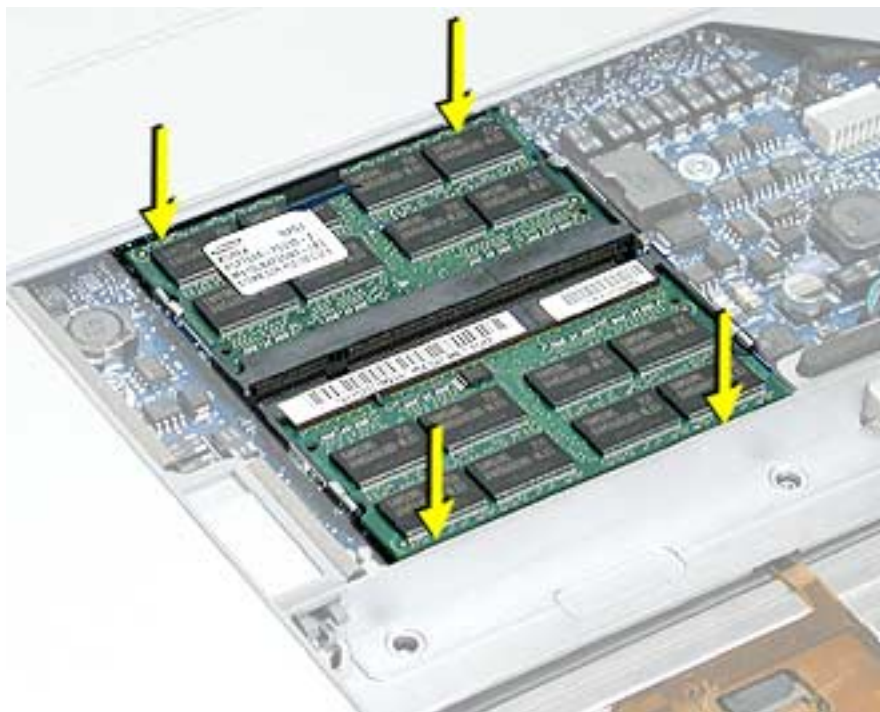

8. To reinstall the memory door, hold it at a low angle to the battery bay and slide it in under the back edge, then lay it flat. If the door springs up and does not lay flat without tension, remove it and reinstall at a lower angle.



9. Install the memory door screws.

Note: Before securing, check that the door edge rests flush and inside the ridge.



10. Replace the battery.

11. Use Apple System Profiler to verify that the memory is recognized. (Choose the menu bar Apple logo (🍏) > About This Mac, click More Info..., select the System Profile tab, open the Memory Overview.)



Top Case

Tools

This procedure requires the following tools:

- #0 Phillips screwdriver (magnetized)
- #1 Phillips screwdriver (magnetized)
- Torx T8 screwdriver (magnetized)
- Black stick (or other nonconductive nylon or plastic flat-blade tool)
- Soft cloth
- Multi-compartment screw tray (21 screws to remove the top case)

Part Location



Preliminary Steps

Before you begin, remove the following:

- Battery
- Memory door
- Lower memory card (nearest to battery bay), if present

Procedure

Note: This procedure removes the top case and keyboard assembly. The keyboard is attached to the top case and is not removed.

1. Place the computer face down on a soft cloth.
2. Remove the three screws inside the battery bay.

Note: These screws are shorter than on the memory door. Use care not to lose the screws into holes along the battery bay.

Note: Check for lost screws caught by magnets inside the front edge of the battery well.

3. Remove the five screws along the back edge (the two outside screws are longer and have “shoulders”).
4. Remove the two screws on the logic board.

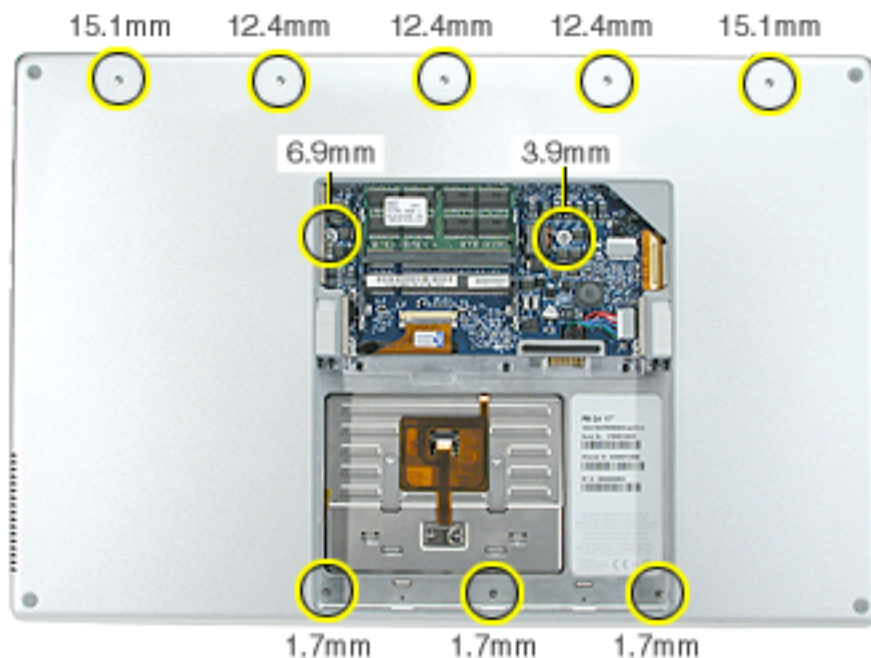

5. Locate the top case flex cable and ZIF connector.

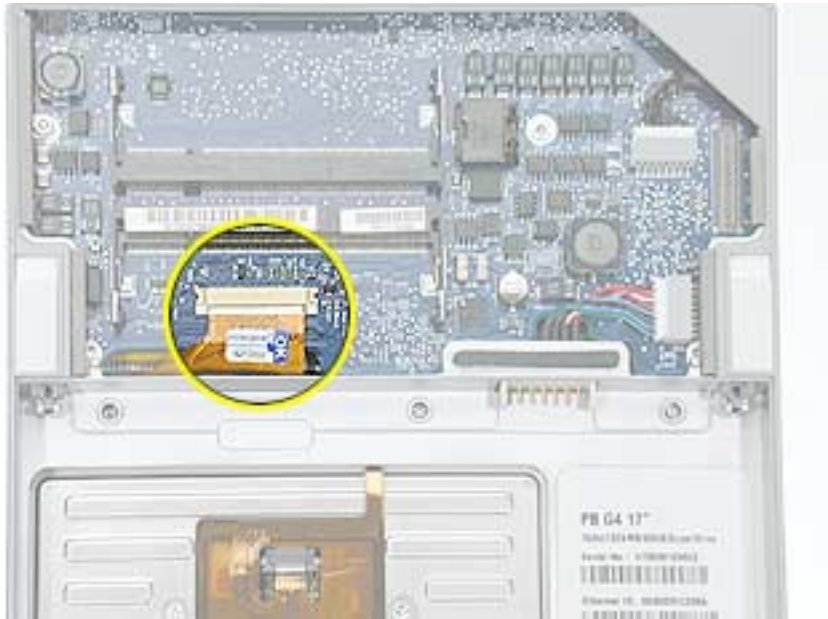

6. Very carefully disconnect and remove the cable from the connector.

Important: The ZIF connector and locking bar are fragile and can easily break if too much force is used. (See “Zero Insertion Force Connectors” heading.)

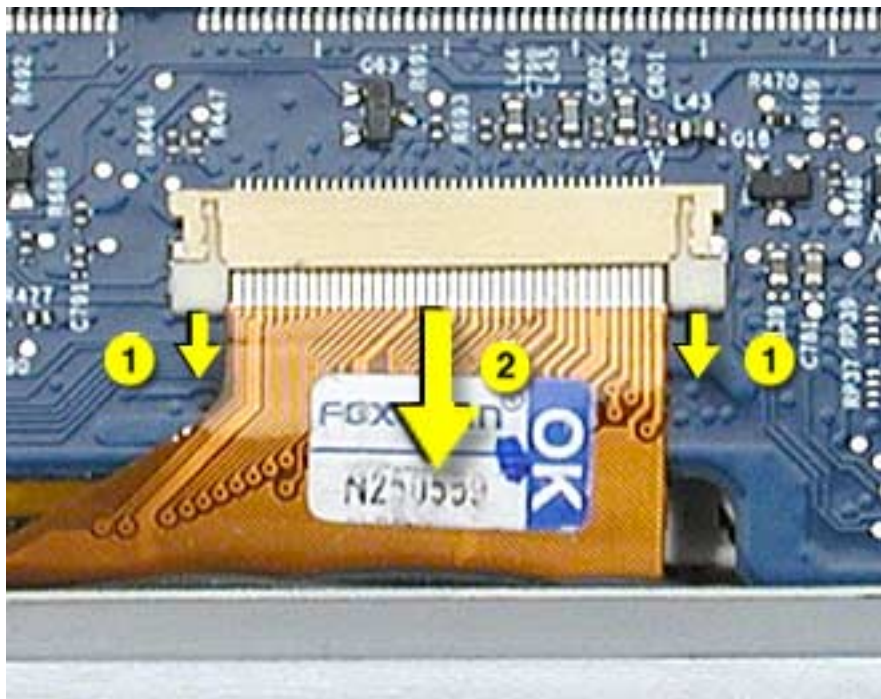

7. Open the display and place the computer on its side.
8. Remove four side screws from both sides.

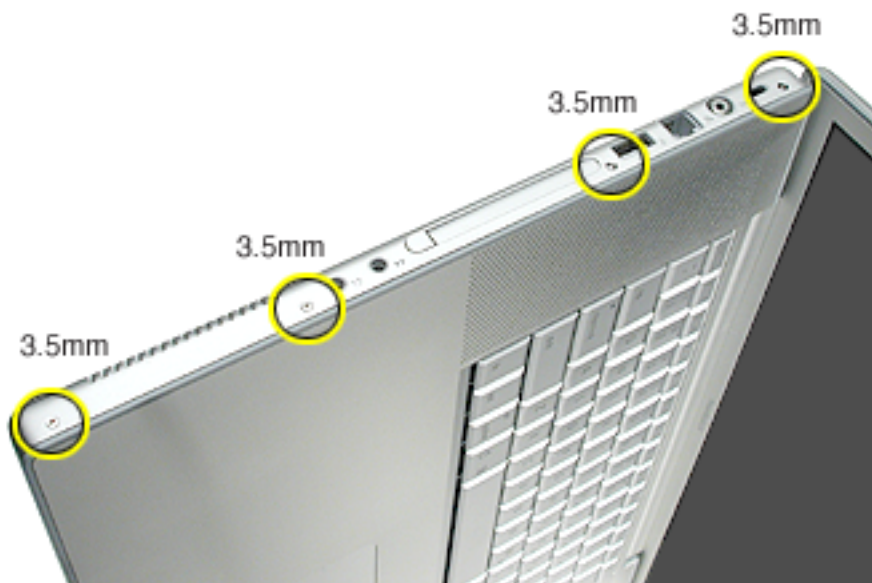
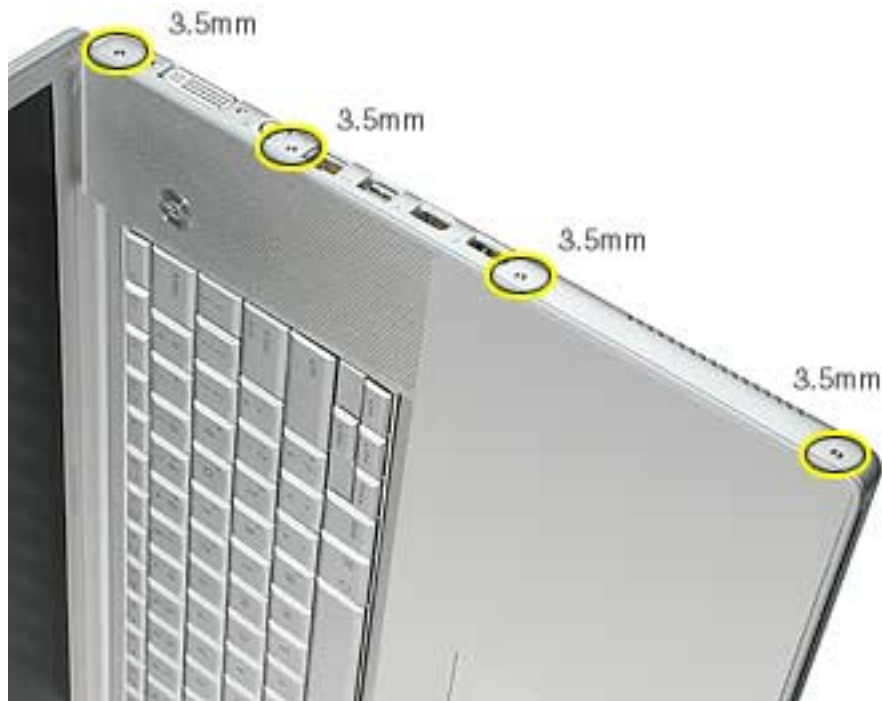

9. Turn the computer over.
10. Pull up on the top case along the sides and front until it releases.



Note: A black stick inserted and twisted under the top case seam may be helpful.



Replacement Procedure

Note: If replacing the top case, remove the keyboard and transfer it to the replacement top case.

1. Verify the thermal pad shown here is in place. If not, check whether it is stuck under the removed top case and replace. If not, install a new pad.



2. Visually check to verify that all cables (highlighted below) are connected and routed correctly with nothing raised up or incorrectly over a component.

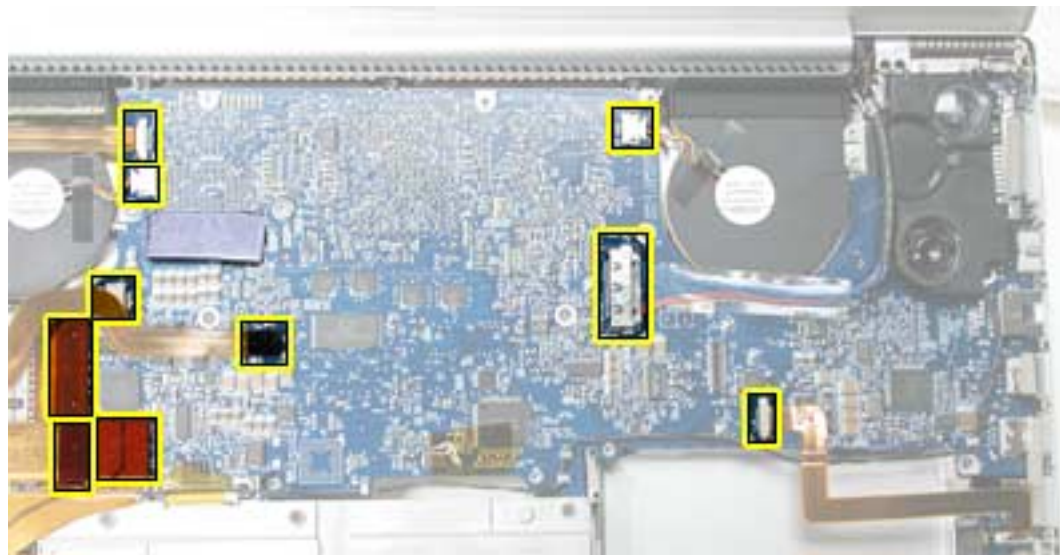

3. Check perimeter wiring, where shown, to verify that it will not be caught or pinched by the top case during replacement.



4. Check that display cable brackets are properly seated and secured with screws.

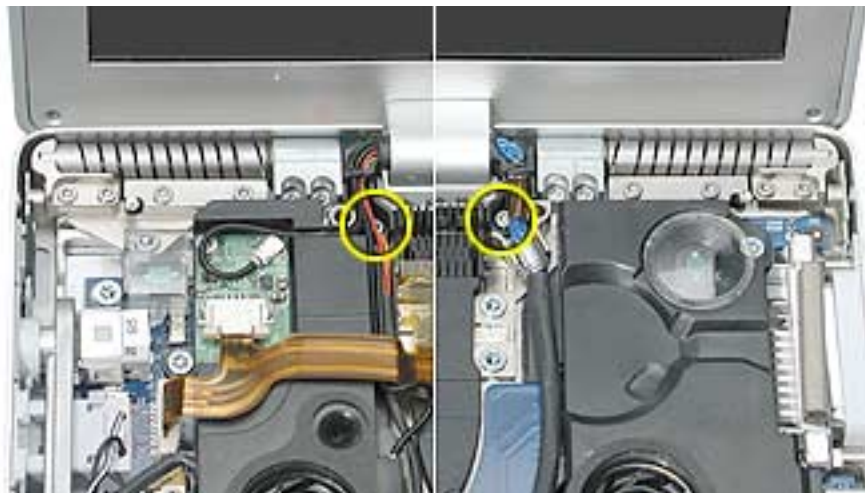

5. Verify that cables for Bluetooth, AirPort Extreme, inverter and power cable from the DC-in board are routed and seated correctly in channels around the left speaker.



6. Verify that the LVDS cable's metal bead fits into the metal channel (rounded side up so that its teeth secure it) and that the cable is secured into the channel along the right speaker.

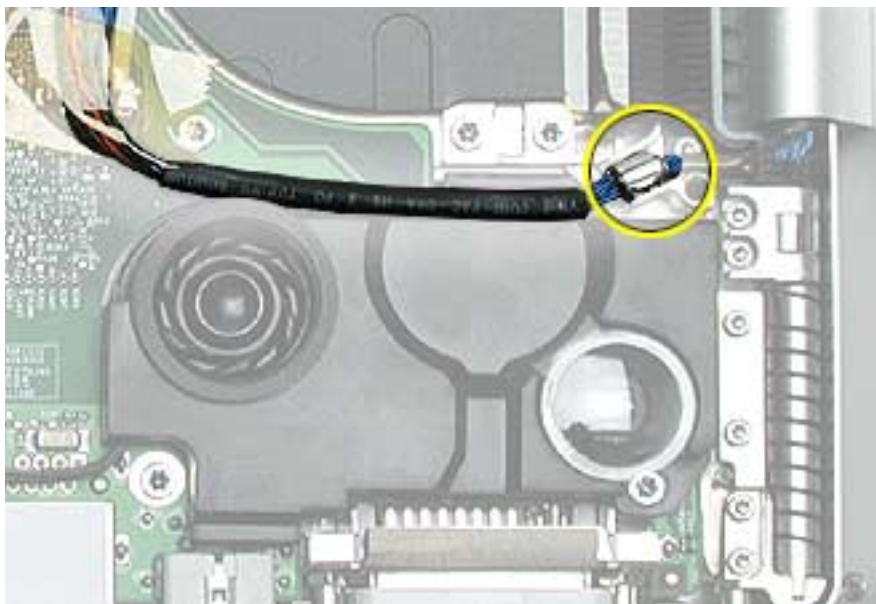

7. Verify that the sleep LED wires route over the notch in the frame (secure with Kapton tape) and along the inside channel away from the front edge so that it will not be damaged when replacing the top case.



8. On the top case, check cable connections and routing.

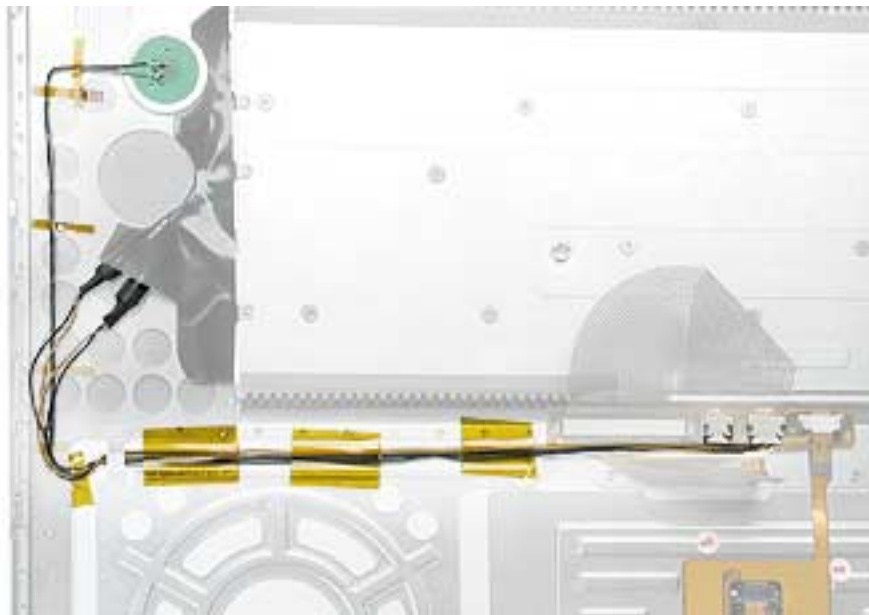

9. Check that the perimeter metal tabs are not bent.

Note: Do not bend the tabs; the metal quickly fatigues and can break off easily.

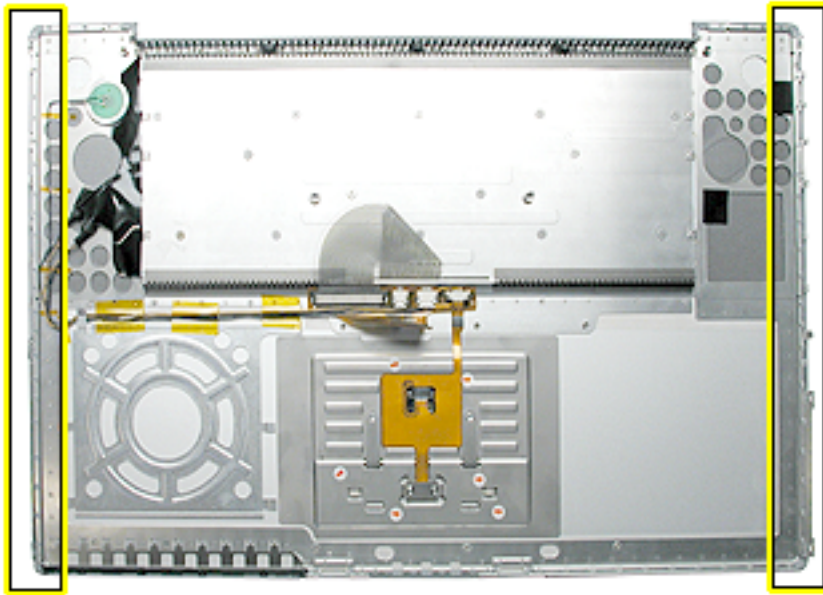

10. Lay the top case upside down and locate the flex cable.
11. While pulling the cable up, run a finger along its base to crease it at a 90-degree angle.



12. The cable should point straight up.



13. Open the display to 90-degrees and tilt the computer back so it rests on the back of the display.

14. Guide the top case flex cable through the slot between the logic board and the bottom case frame.



Note: For the following procedures, you will want to keep the top case close to the bottom case so the flex cable will not pull out of the slot.

15. Turn the computer to rest on the bottom case.
16. At the left front corner of the computer, insert the top case edges into the bottom case channels, shown.

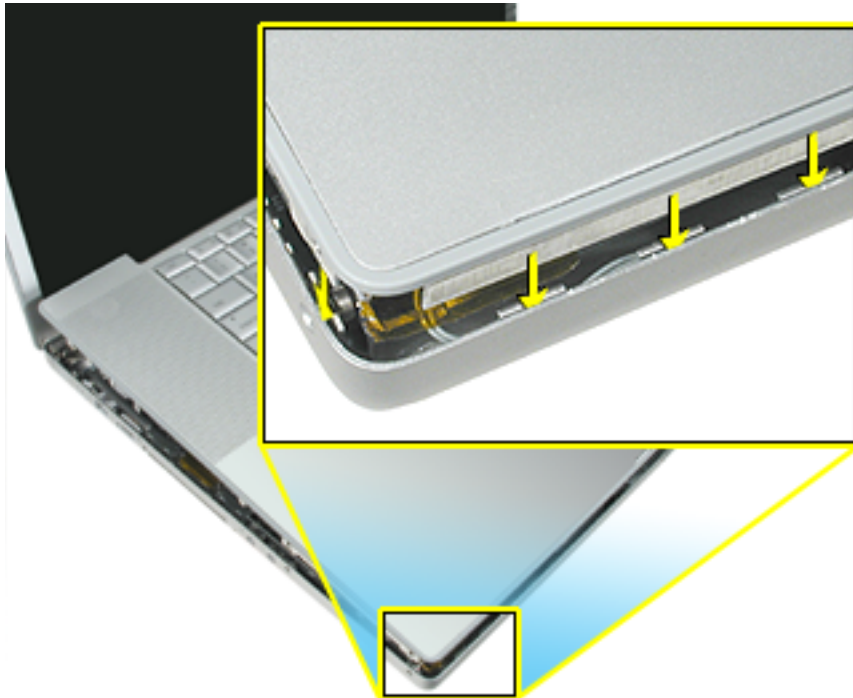

17. Hold the front of the top case along the front edge of the bottom case and lower into place.



18. **Note:** If the tabs along the sides of the top case catch on the bottom case, use a narrow tool and work from front to back to carefully push or pull the tabs very slightly to help slide them into place.

Important: The tabs are fragile. Do not apply too much pressure or bend them.



Note: Some side screws have a flexible screw boss. If they block a tab from seating, use a narrow tool to push the boss slightly.



Important: The top case should lay flat along the sides and top, if not, make sure that cables and components are not interfering.

Also, make sure it is not held up by one of the metal tabs protruding down from the top case. Carefully bend them slightly to fit if needed.

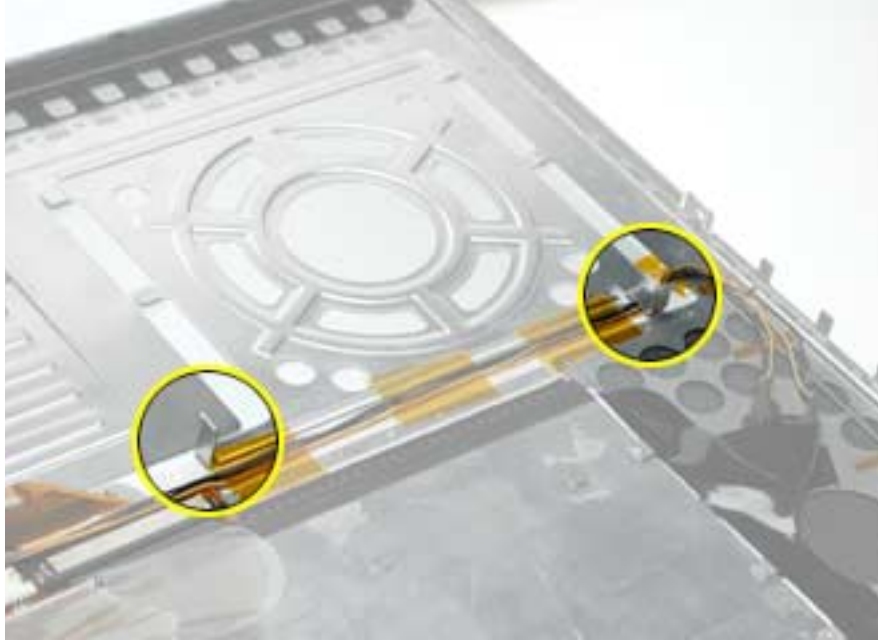

19. Install the front and rear side screws on both sides to hold the top case in place.



20. Carefully close the display, without forcing. If it does not close easily, reinstall the top case, checking for cable routing and clearances.
21. Turn the computer over.
22. Check that the top case flex cable is still through the slot. If not, use the round shaft of a small Phillips screwdriver to carefully pull it through, as shown.

Important: If the cable does not fully reach the ZIF connector, the cable is trapped under the frame. Reinstall the top case.

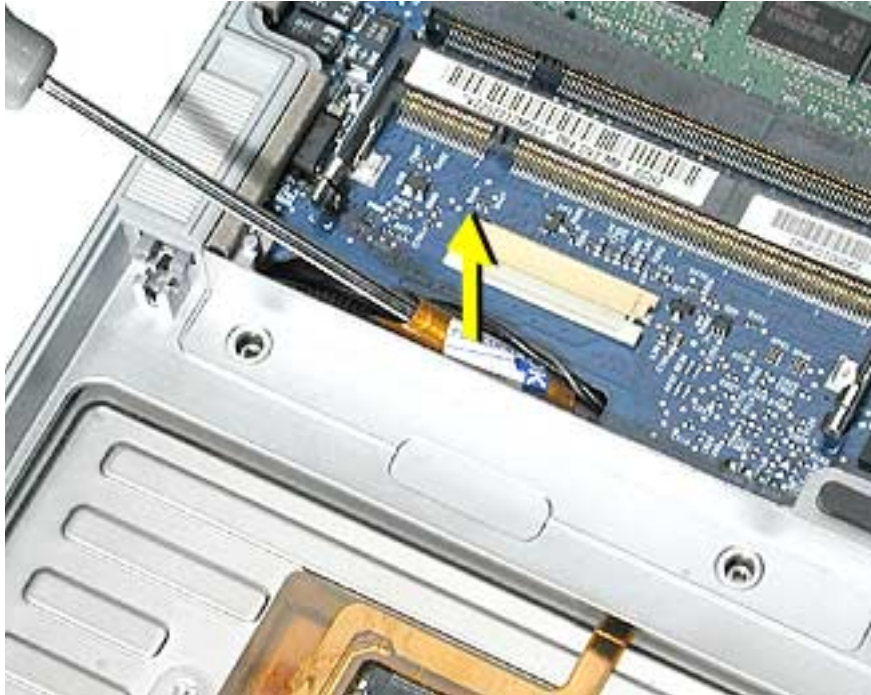

23. Carefully pull the locking bar of the ZIF connector out slightly. Slide the flex cable over the locking bar and into the connector until it stops (the metal edge of the cable should be parallel to the connector), then slide the locking bar in to secure it.

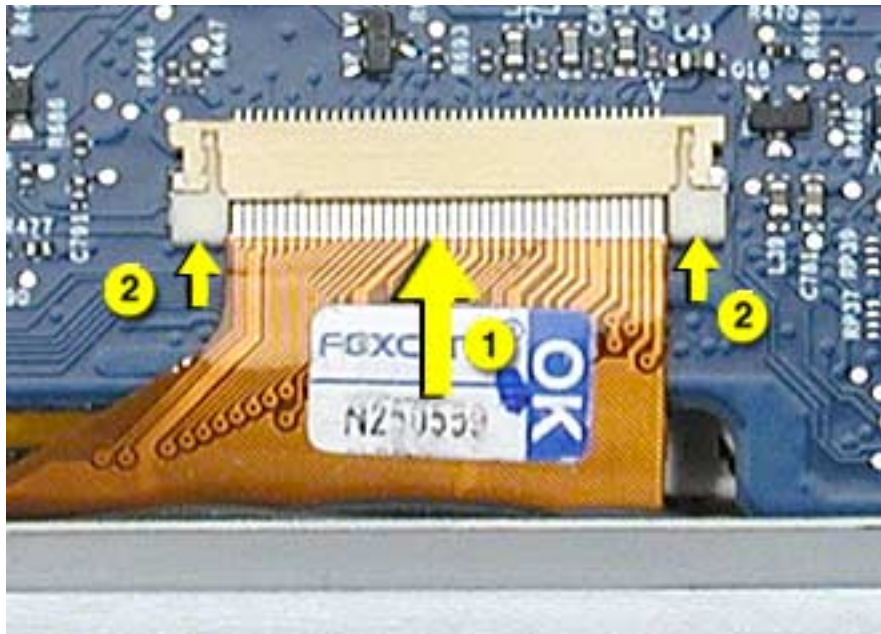

24. Check for a gap, as shown below, between the top and bottom case at the back right side next to the hinge. This may indicate that the LVDS cable is trapped.



-
25. To check this, insert the flat-blade side of a black stick between the display and top case then push toward the bottom case to see if the gap can be closed. If so, proceed to next step. If not, remove the top case and check the routing of the LVDS cable, then reinstall the top case.



26. Carefully install one of the “shoulder” screws in the end screw hole on the bottom.

Important: If the screw does not go in easily do not force it or damage may result. Check the routing of the LVDS cable and reinstall the top case.



-
27. Install the other “shoulder” screw in the end screw hole.
 28. Install the remaining side screws.
 29. Install the logic board screws.
 30. Install the remaining bottom screws along the back edge.
 31. Install the memory door, and screws.
 32. Install the battery bay screws.
 33. Visually check the flatness of the top case. If it is not flat, remove it, fix the problem, then reinstall.
 34. Replace the battery.
 35. Testing the computer should include powering on, checking the keyboard and trackpad function, and operate the computer in a dimly lit room to check that the keyboard backlight is working.



Keyboard

Tools

This procedure requires the following tools:

- #0 Phillips screwdriver
- Torx T8 screwdriver (or other blunt tool, 3.5mm wide or less)
- Black stick (or other nonconductive nylon or plastic flat-blade tool)

Part Location



Preliminary Steps

Before you begin, remove the following:

- Battery
- Top case

Procedure

1. Turn the top case over, locate the keyboard flex cable and remove the Kapton tape holding the cable.
2. Carefully release the locking bar of the cable's ZIF connector and pull out the cable.



3. Locate and carefully peel off the insulator film over keyboard screws and reserve for reinstallation.

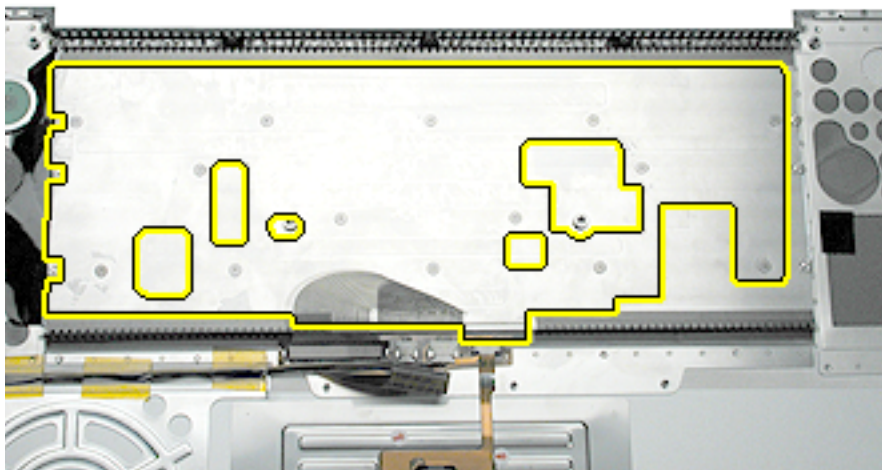

4. Remove remaining adhesive, if any, from the top case and screw heads.
5. Remove the fourteen identical screws.

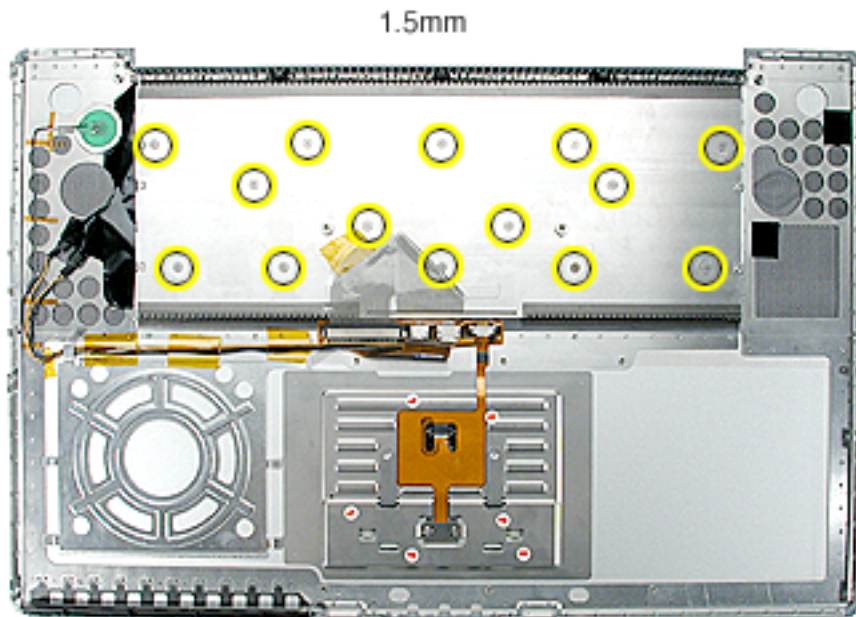

6. Start at the power button side and use a blunt tool (no wider than 3.5 mm) to carefully push on the keyboard screw bosses through the boss holes to begin to release the keyboard from its adhesive.

Important: To avoid damaging the screw boss threads, do not use a narrow tool that will fit into the screw hole.

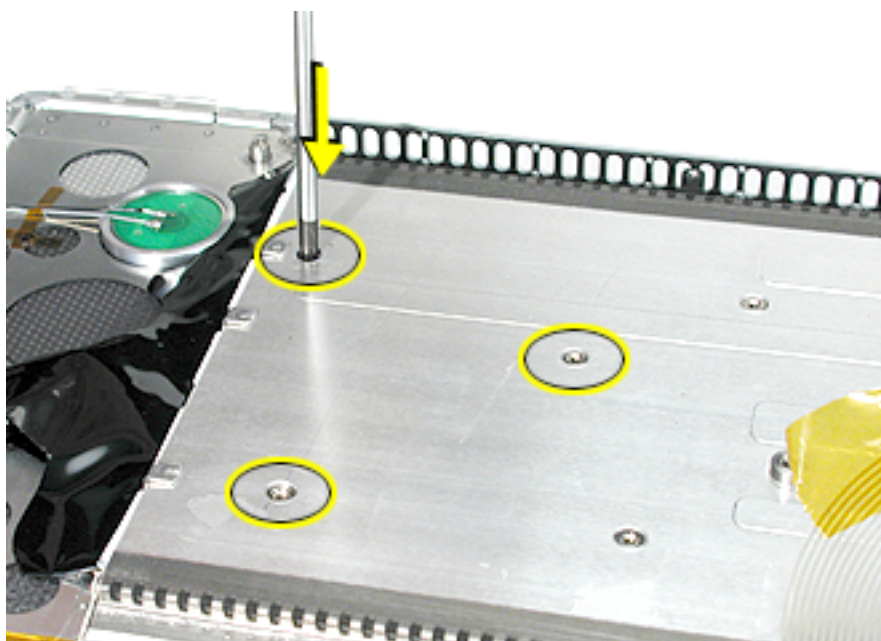

7. Continue until the keyboard can be grasped, then carefully lift it up and guide out its flex cable (shown below).

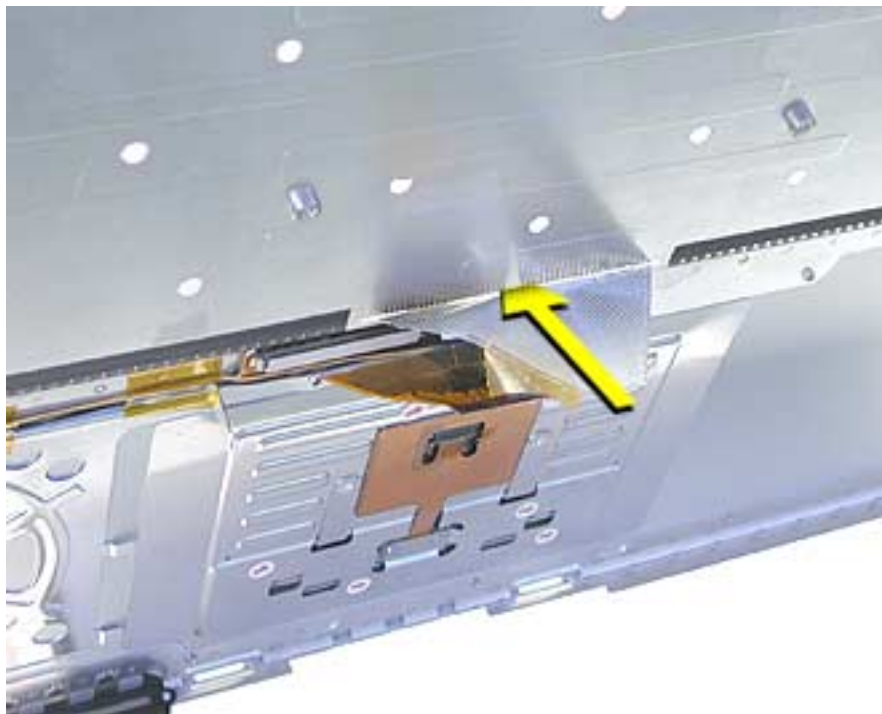

-
- Carefully rub off any adhesive residue left in the keyboard well and on the fiber optics.

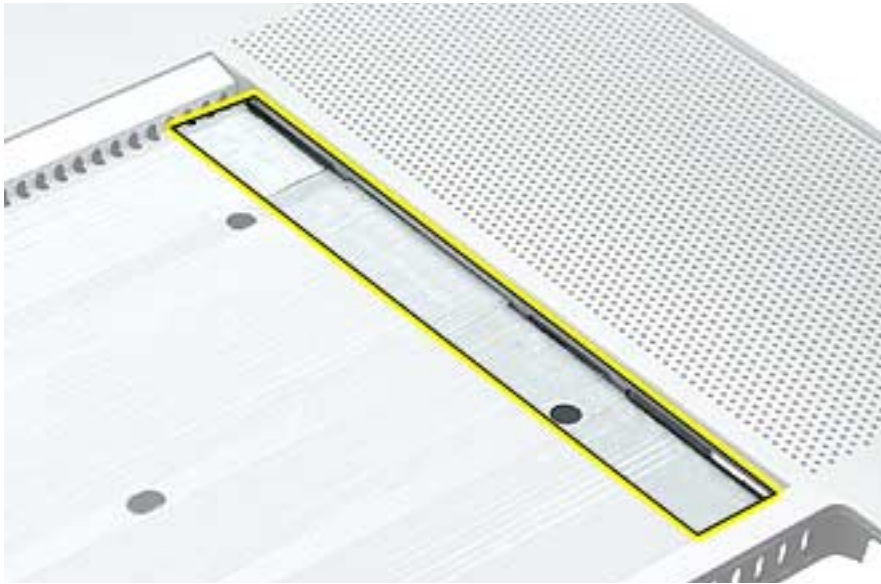

Replacement Procedure

1. To install the keyboard or replacement keyboard, insert its flex cable through the slot in the top case and rest the bottom of the keyboard evenly along the bottom edge of the keyboard well.
2. Remove the protective cover from the adhesive strips on the keyboard. While keeping the bottom of the keyboard flush along the bottom, lay the keyboard into place so that the screw bosses fit into the boss holes.

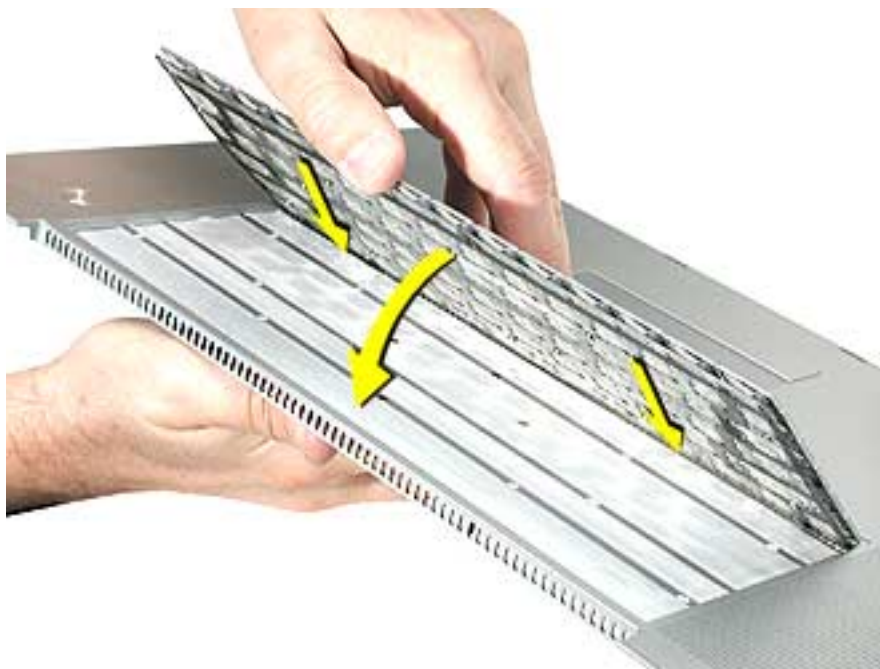

3. Install the keyboard screws.
4. Replace the insulator film, avoiding wrinkles or bulges.

Important: The film must be installed in the same location to protect against contact and electrical shorting in certain areas and to allow contact with the EMI spring on the logic board.

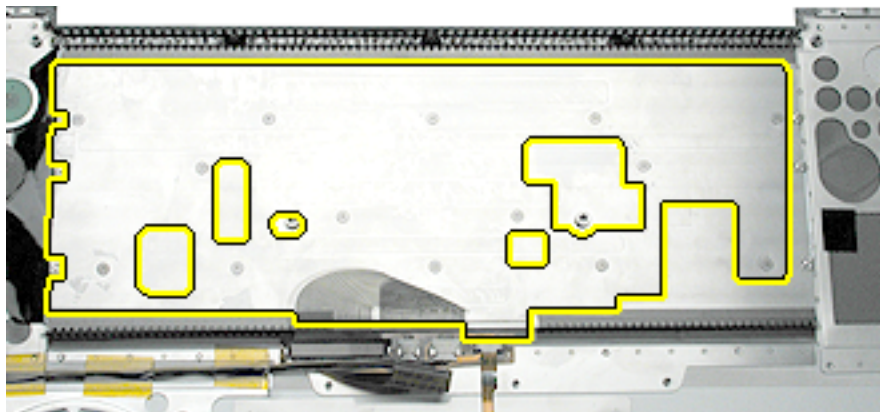

5. If replacing the existing keyboard, such as during a top case replacement, secure the end of the keyboard flex cable. (The cable inserts under the ZIF connector locking bar.)
6. If installing a replacement keyboard, first remove the cable's adhesive protector, then turn the cable under itself (so the adhesive is on the inside of the loop but do not secure the adhesive).

Secure the end of the keyboard flex cable into the ZIF connector. (The cable inserts under the ZIF connector locking bar.)

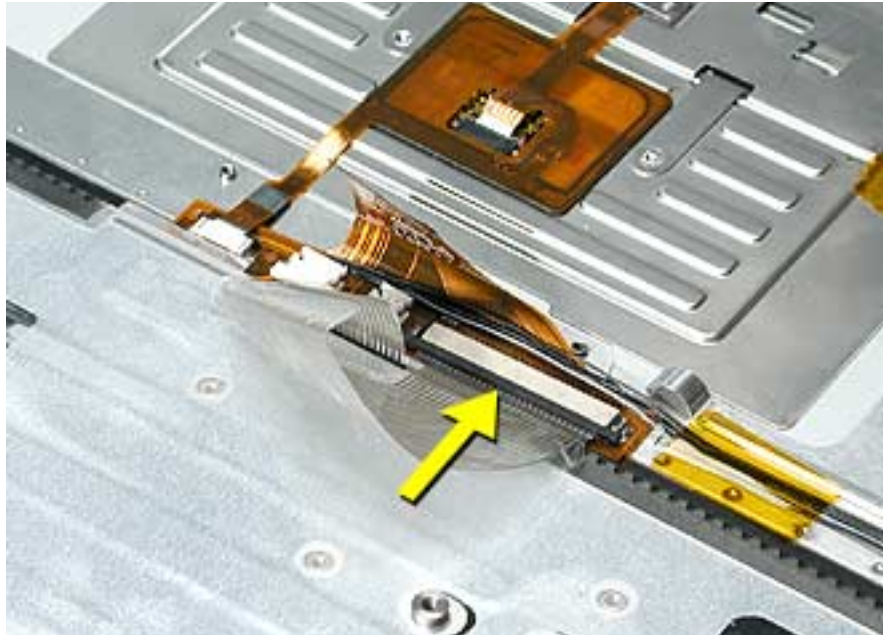

7. Fold the cable flat and secure its adhesive by firmly holding the left side (to prevent cable movement) while sliding your right hand fingers forward on the right side.

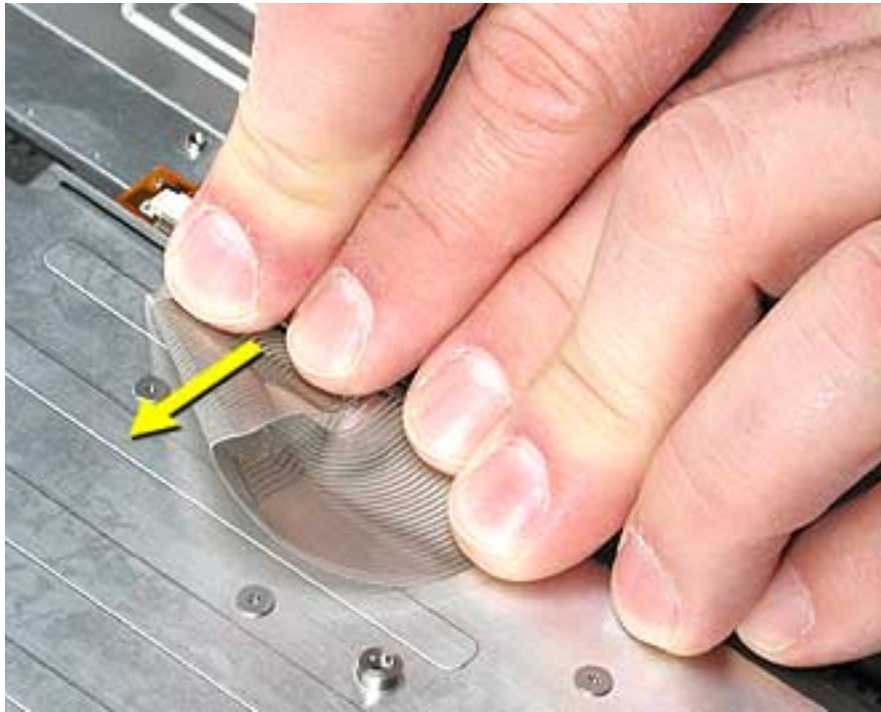

8. Use Kapton tape to secure the cable flat at the fold.

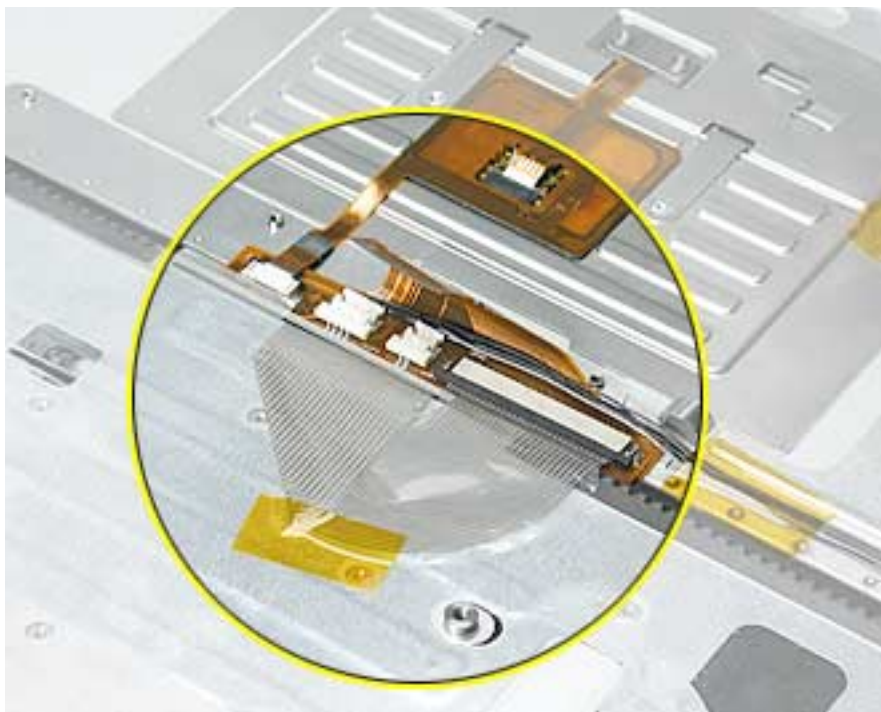

9. Verify that the cable is still fully inserted, straight and secure in the connector.
10. Turn over the top case and inspect the left and right sides of the keyboard. Push any Mylar down along the sides of the keyboard.



11. Reassemble the computer.
12. Testing the computer should include powering on, checking the keyboard and trackpad function.

In a darkened room, check for keyboard backlight function, and light leakage around the perimeter of the keyboard, speaker grill openings and side ports.



Hard Drive

Tools

This procedure requires the following tools:

- Torx T8 screwdriver (magnetized)
- #1 Phillips screwdriver (magnetized)

Part Location

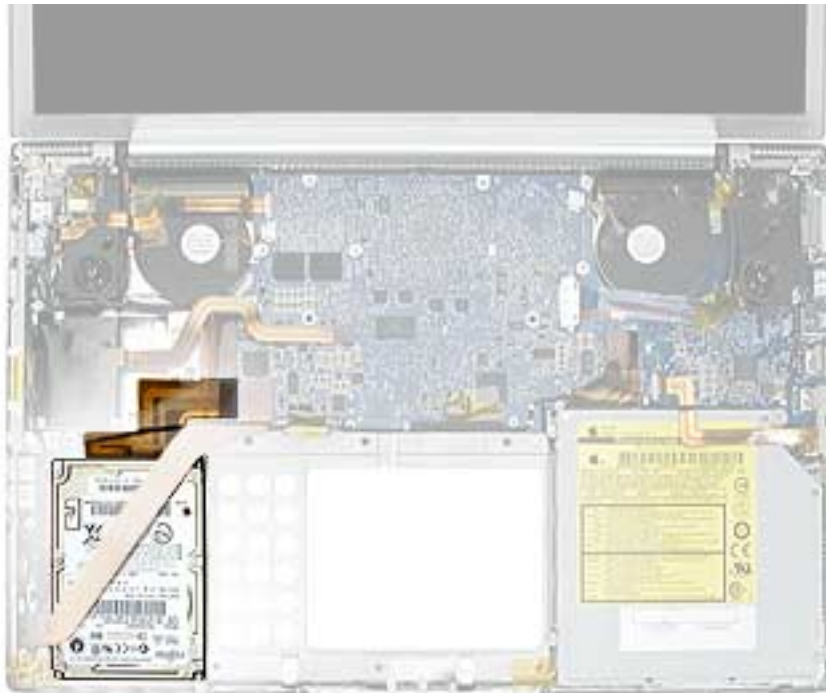

Preliminary Steps

Before you begin, remove the following:

- Battery
- Top case

Procedure

1. Use the tabs on the connectors to disconnect and remove the sound board flex cable.

Note: Remove the connector from the logic board by rocking from side to side.

2. Disconnect the hard drive flex cable.



3. Remove the four screws.

4. Lift out the hard drive (guide the flex cable under the speaker cables if necessary).

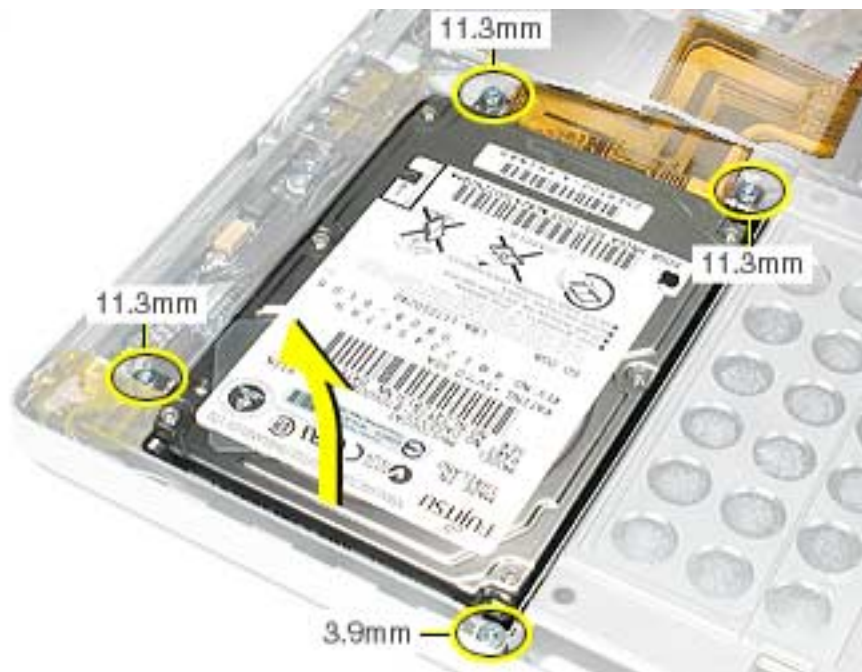

5. Transfer brackets, side screws, rubber shockpads and the flex cable to the replacement hard drive.



6. Install the replacement hard drive, and reassemble the computer.
7. Testing the computer should include powering on, checking that the hard drive is recognized, checking for sound from the speakers and that the sleep LED light works.



Sound Board

Tools

This procedure requires the following tools:

- Torx T8 screwdriver (magnetized)
- Black stick (or other nonconductive nylon or plastic flat-blade tool)

Part Location

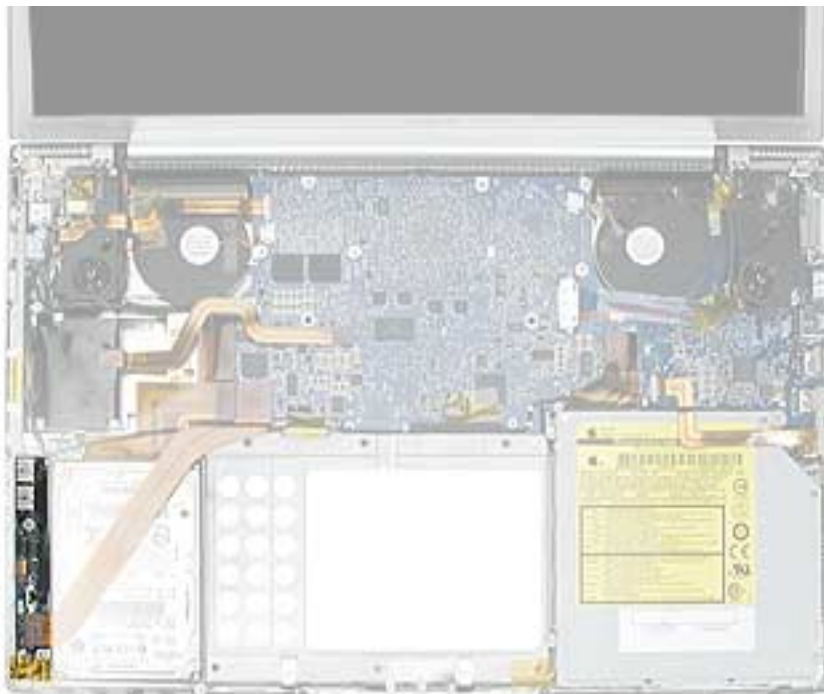

Preliminary Steps

Before you begin, remove the following:

- Battery
- Top case
- Hard drive

Procedure

1. Disconnect the speaker wires connector and sleep LED connector.
2. Remove the two screws.

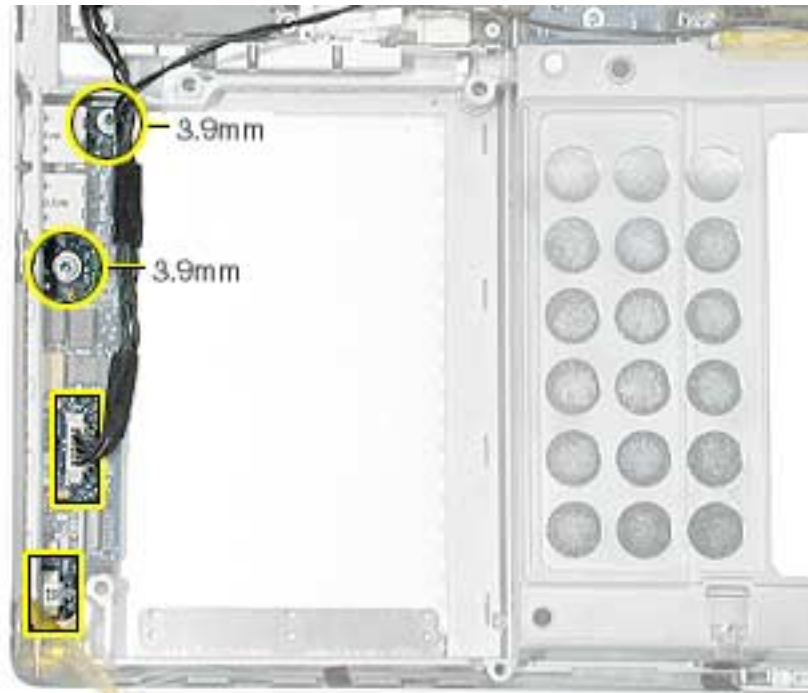

3. Pull the sound board out starting at the ports end.

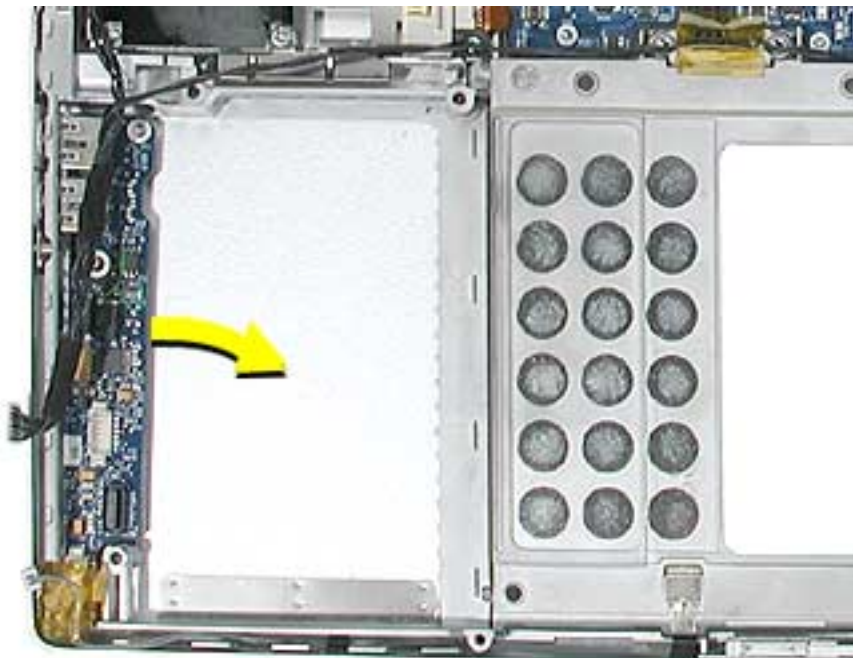

Replacement Note: To prevent damage to the sleep LED wires during top case reassembly, verify that the wires route over the notch in the frame (secure with Kapton tape here and over connector) and then along the inside channel away from the front edge.



4. Install the replacement sound board, and reassemble the computer.
5. Testing the computer should include powering on, checking for sound from the speakers and that the sleep LED light works. The headphone and line in ports should be checked.



SuperDrive

Tools

This procedure requires the following tools:

- Torx T8 screwdriver (magnetized)
- #1 Phillips screwdriver (magnetized)

Part Location

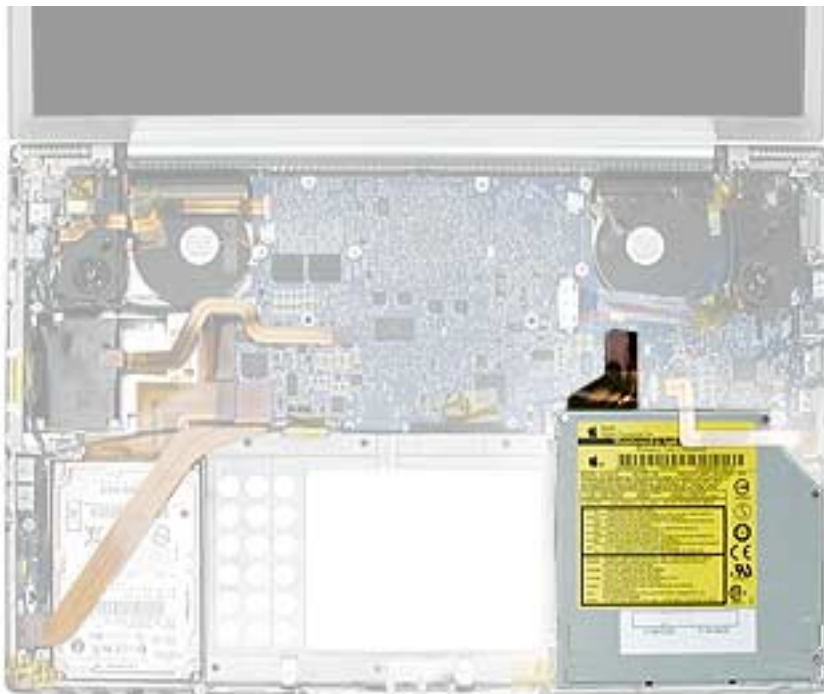

Preliminary Steps

Before you begin, remove the following:

- Battery
- Top case

Procedure

1. Grasp the SuperDrive flex cable connector, where shown, and rock from side to side while pulling up, to disconnect it.

Warning: Do not pull up on the end of the flex cable connector or the cable may separate from the connector.

2. Remove the four screws.
3. Carefully lift and guide the drive out.

Important: Avoid pulling on the backup battery flex cable.

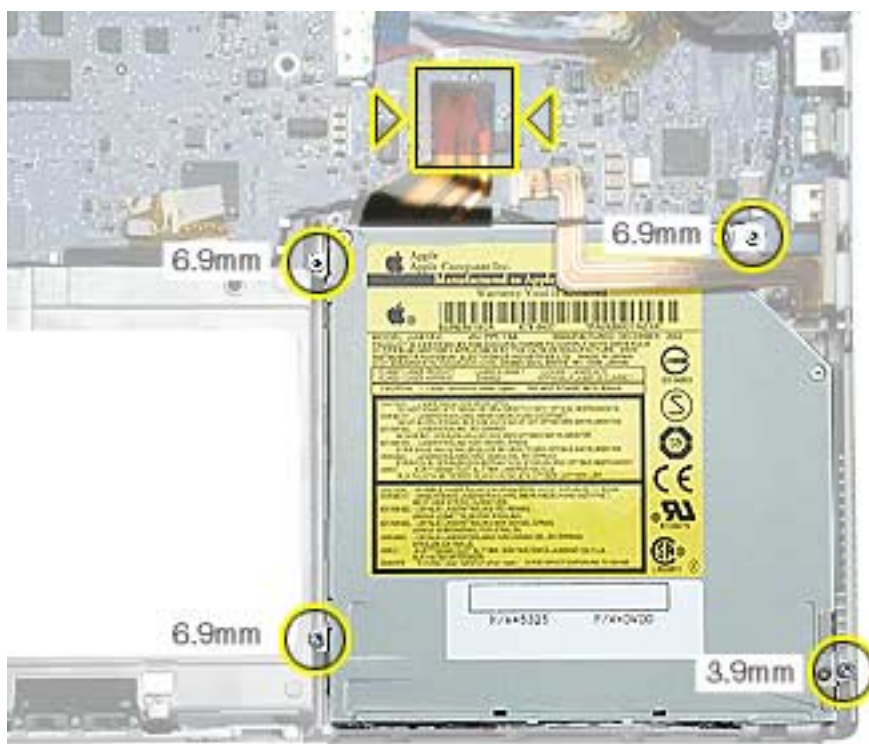

4. Transfer the flex cable, brackets and screws to the replacement SuperDrive.



5. Install the replacement SuperDrive, and reassemble the computer.
6. Testing the computer should include powering on, inserting a CD and ejecting it to make sure the drive is aligned with the opening and functioning properly.



Backup Battery Board

Tools

This procedure requires the following tools:

- Torx T8 screwdriver (magnetized)
- Black stick (or other nonconductive nylon or plastic flat-blade tool)

Part Location

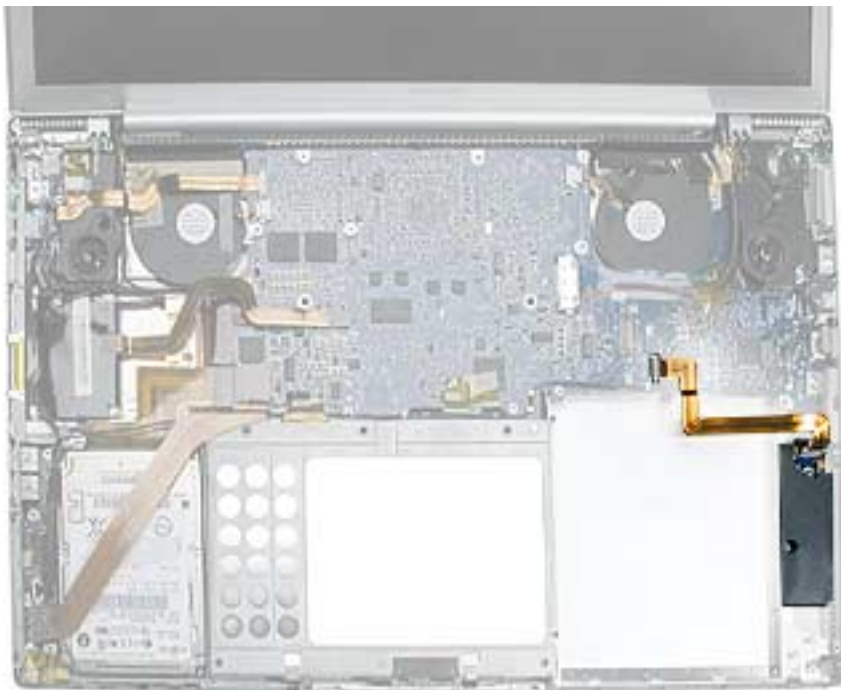

Preliminary Steps

Before you begin, remove the following:

- Battery
- Top case
- SuperDrive

Procedure

1. Release the two ZIF connectors and remove the flex cable.
2. Remove the three screws.

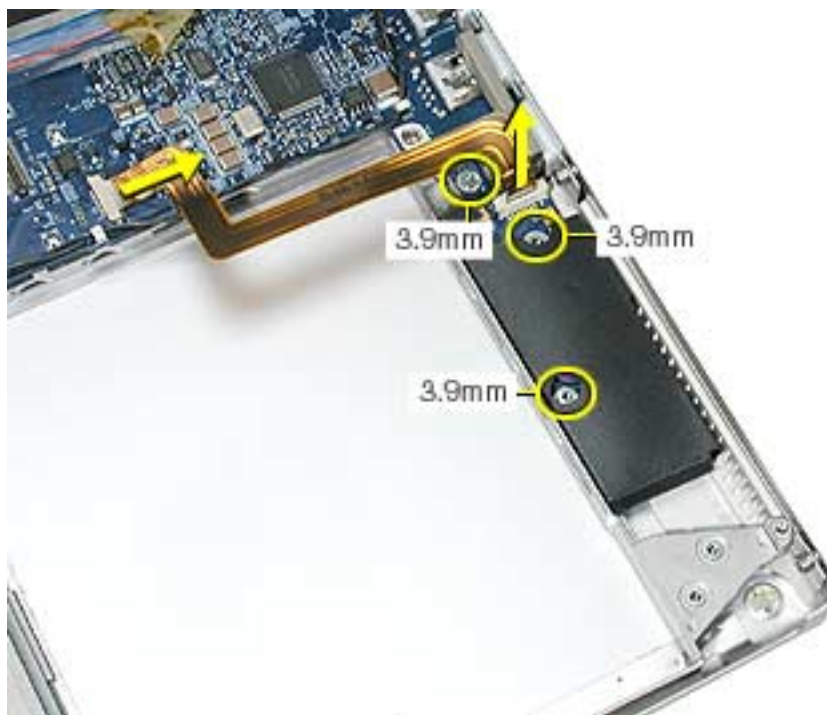

3. Install the replacement backup battery board.
4. Reassemble the computer.
5. Testing the computer should include plugging in the power adapter and letting the backup battery charge for half an hour. Then power on the computer and disconnect the power adapter, set the system clock, put the computer to sleep, remove the main battery for five seconds and reinstall. The time should not reset. Also, check the right side USB port which is on the backup battery board.



Modem

Tools

This procedure requires the following tools:

- 4 mm socket wrench
- Needlenose pliers (helpful to reinstall hex nuts)

Part Location

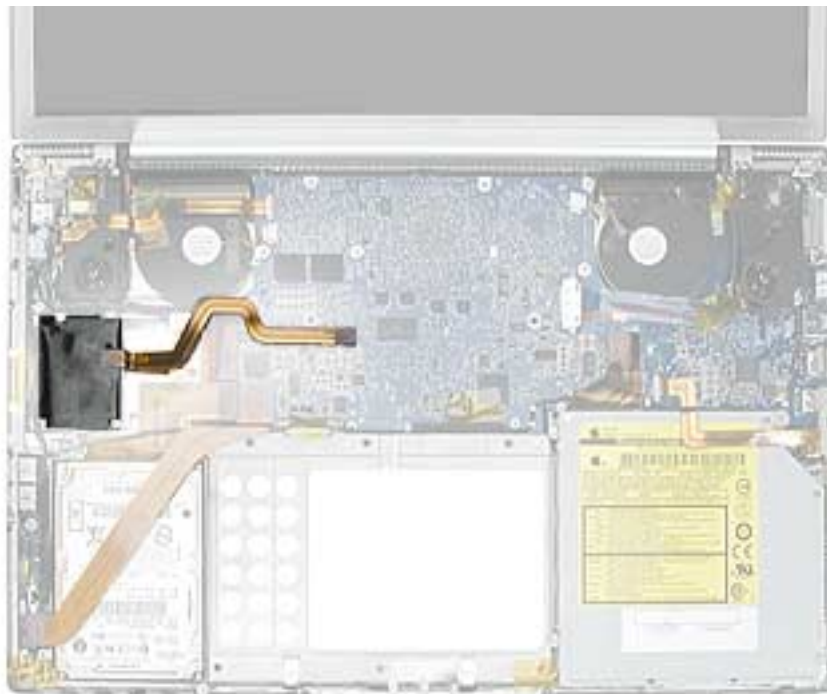

Preliminary Steps

Before you begin, remove the following:

- Battery
- Top case

Procedure

1. Disconnect the modem flex cable.
2. Remove the three hex nuts.

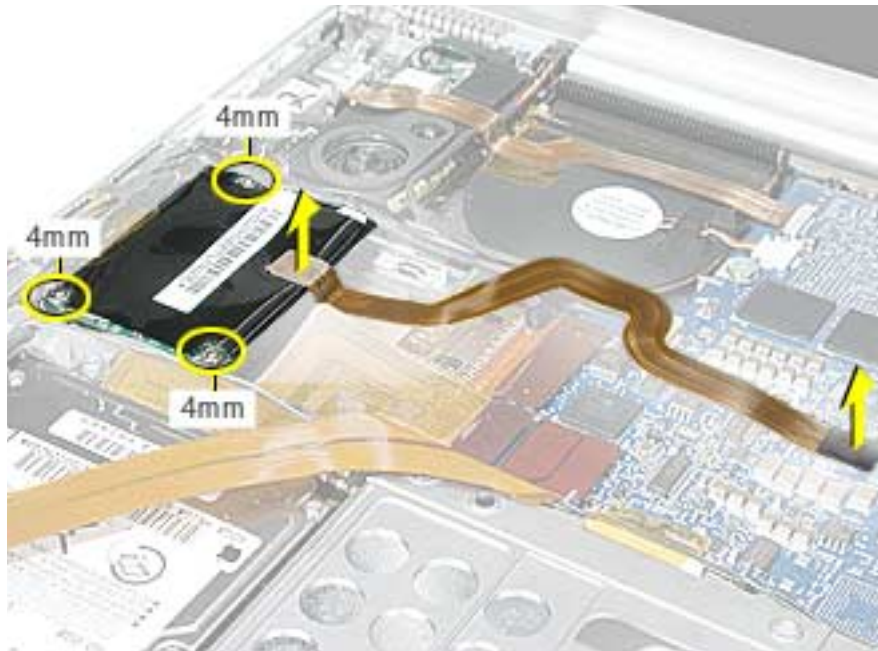

3. Lift the modem up slightly and disconnect the RJ-11 cable connector.



4. Install the replacement modem, and reassemble and test the computer.



PC Card Cage and AirPort Extreme Assembly

Tools

This procedure requires the following tools:

- #0 Phillips screwdriver (magnetized)
- Torx T6 screwdriver (magnetized)
- Black stick (or other nonconductive nylon or plastic flat-blade tool)

Part Location

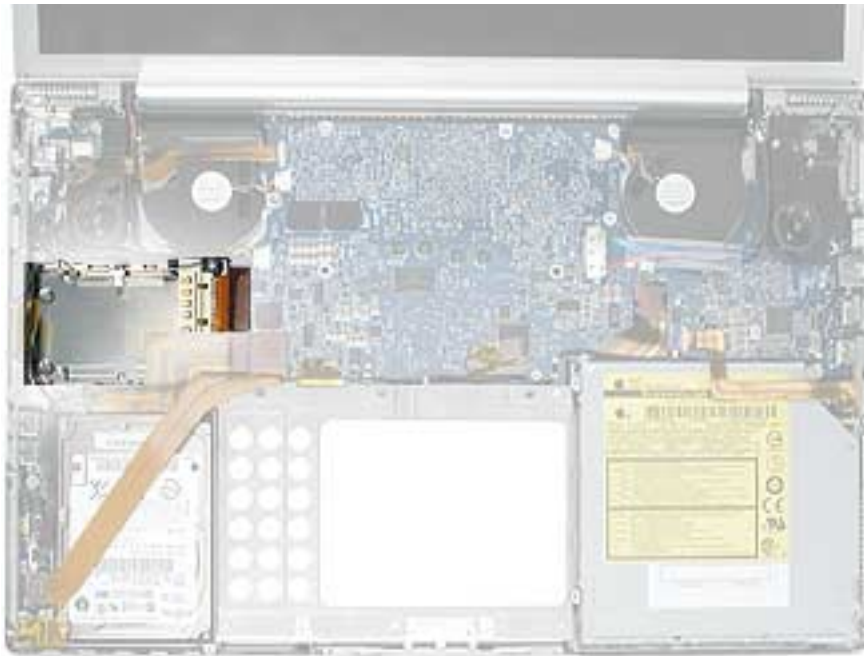

Preliminary Steps

Before you begin, remove the following:

- Battery
- Top case
- Modem

Procedure

1. Turn the computer over and remove the rubber gasket on the AirPort Extreme flex cable connector and reserve for reinstallation. Disconnect the connector.



2. Turn the computer over and disconnect the PC card cage and hard drive flex cables.



3. Pull out the coupling (joining the AirPort Extreme jumper and antenna cable) from the channel in the side of the left speaker. Grasp the coupling (not the wires) at both ends and pull to separate it at the middle.



4. Remove two Phillips screws and two Torx T6 screws.

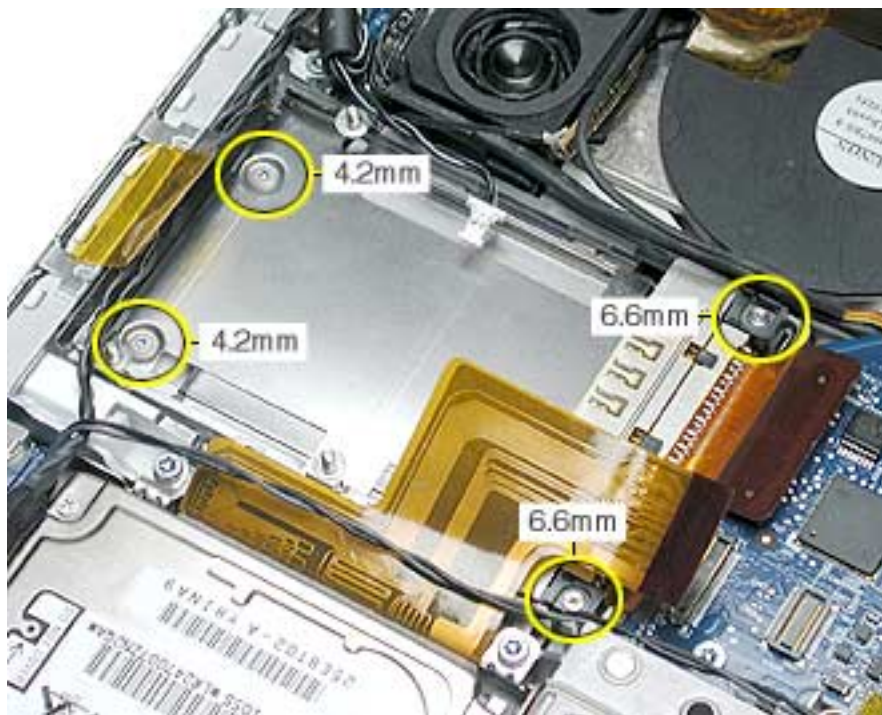

5. **Important:** The cross piece at the front end of the PC card cage is fragile. To avoid damage, do not touch this area while maneuvering the assembly.

Lift up on the sides of the PC card cage assembly and carefully guide the AirPort Extreme card flex cable connector from under the logic board.

Important: To avoid damage, do not allow the pins of the AirPort Extreme card cable connector to rub along the logic board. If the clearance is too tight, try slightly loosening a couple of the logic board screws on this side, but do not bend the board. If this doesn't work, the logic board will have to be removed to continue.



6. Slide out the PC card cage eject button.



7. Turn over the PC card cage to locate the AirPort Extreme card.
8. Pull on the AirPort Extreme card flex cable to slide the card out of the PC card cage.

Note: Wiggling the card from side to side slightly may help to release it.



9. If replacing the AirPort Extreme card, pull the antenna jumper connector straight back to remove it. Transfer the cable extension to the replacement AirPort Extreme card.



10. Install the AirPort Extreme card onto the PC card cage to be installed and reinstall the assembly.

Replacement Note: Ensure that the pin on the PC card cage eject button is secured by the hole in the cage mechanism.



11. Reassemble the computer.
12. Testing the computer should include inserting a PC card to check that it can be locked in and that the eject button works smoothly. Use Apple System Profiler to check that the AirPort Extreme card and modem are recognized. Test that the AirPort Extreme card is working and that the modem can dial out.



Bluetooth

Tools

This procedure requires the following tools:

- Torx T6 screwdriver (magnetized)
- Black stick (or other nonconductive nylon or plastic flat-blade tool)

Part Location



Preliminary Steps

Before you begin, remove the following:

- Battery
- Top case.

Procedure

1. Release the two ZIF connectors and move the flex cable aside.
2. Disconnect the Bluetooth antenna cable.

Replacement Note: Make sure the antenna cable is secured in the channel on the speaker.

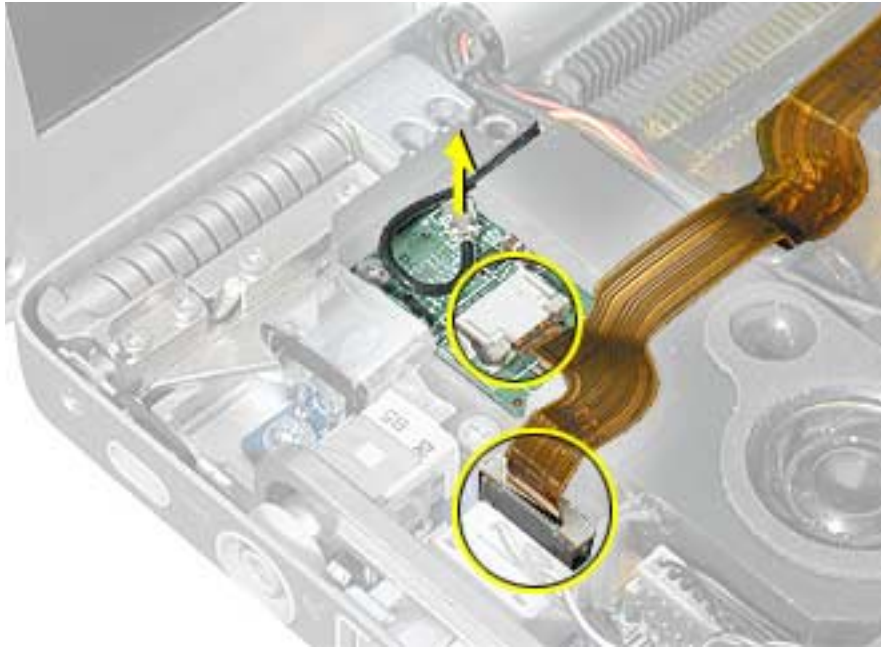

3. Remove the screw and Bluetooth board.



4. Install the replacement Bluetooth board, and reassemble the computer.
5. Testing the computer should include using Bluetooth to connect to another computer. Check the function of the DC-in port and the left USB port.



Speakers

Tools

This procedure requires the following tools:

- Torx T8 screwdriver (magnetized)
- Black stick (or other nonconductive nylon or plastic flat-blade tool)

Part Location

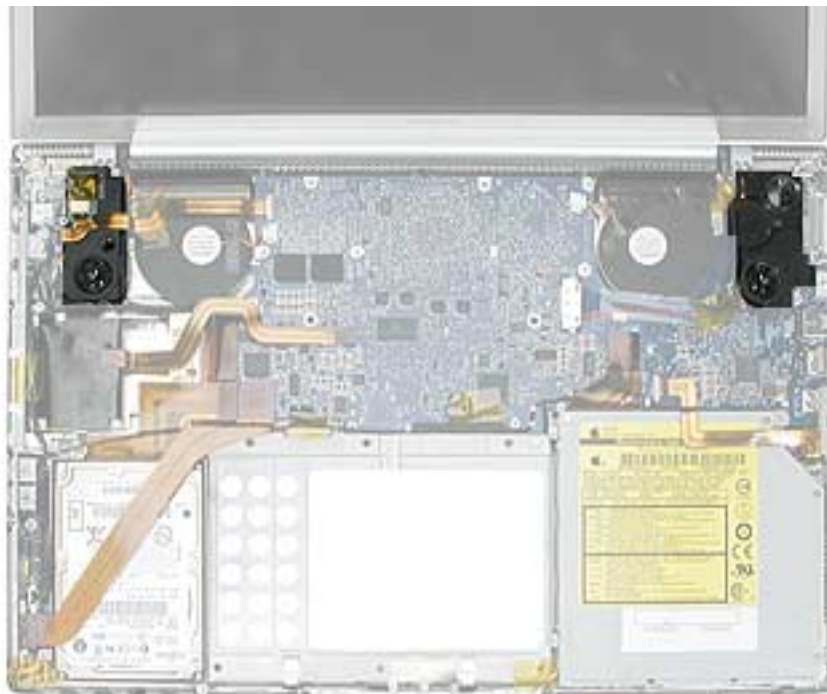

Preliminary Steps

Before you begin, remove the following:

- Battery
- Top case
- Bluetooth board

Procedure

Note: Lift up any Kapton tape as necessary and reserve for replacement.

1. Pull wires out of routing channels on the left speaker.
2. Remove one screw on each speaker.



3. Lift out speakers.
4. Deroute the speaker wires along logic board.

Replacement Note: Verify proper routing of speaker cables under securing clips.



5. Disconnect the speaker wire connector from the sound board.

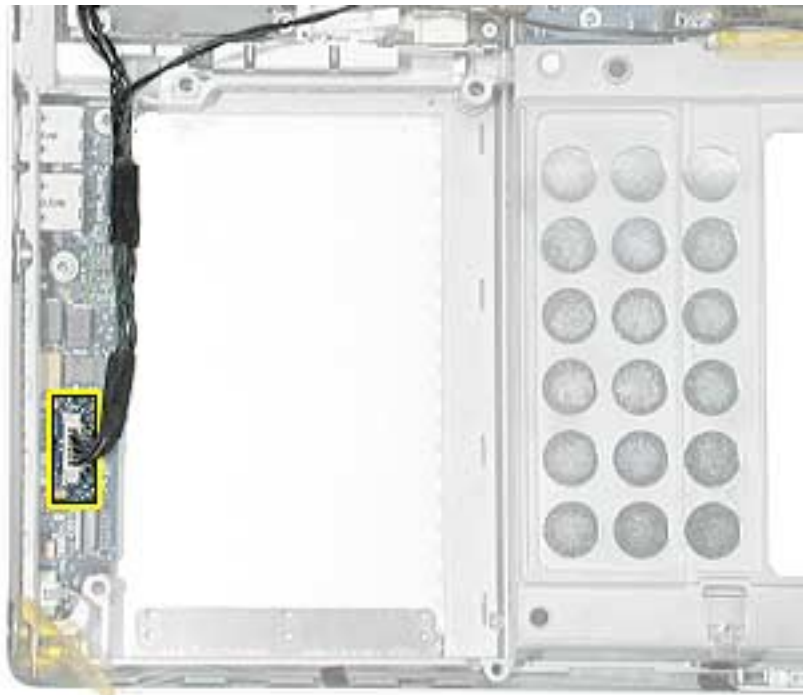

6. Install the replacement speakers, and reassemble the computer.
7. Testing the computer should include using the Sound system preference pane to test the left and right speakers.



DC-In Board

Tools

This procedure requires the following tools:

- Torx T8 screwdriver (magnetized)
- Black stick (or other nonconductive nylon or plastic flat-blade tool)

Part Location

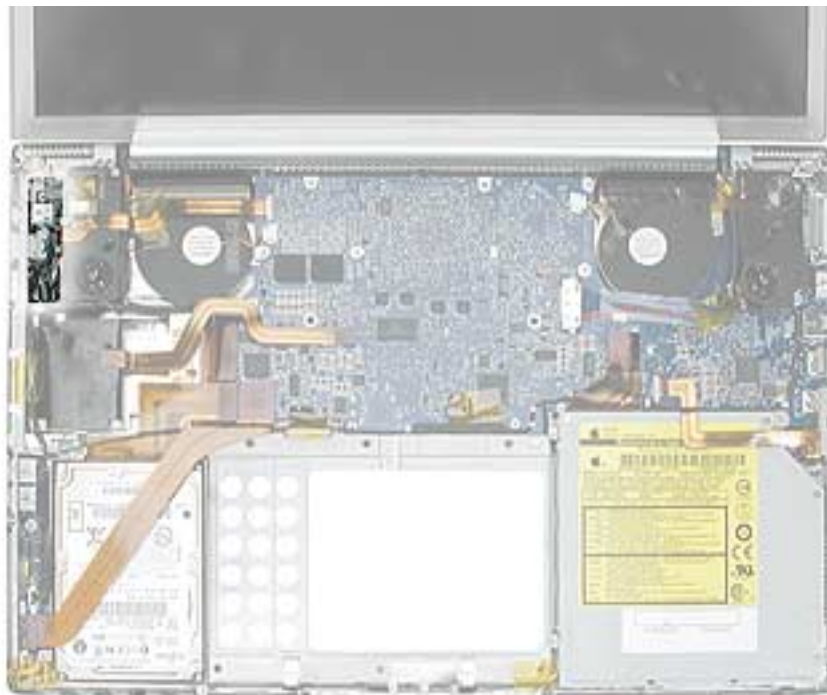

Preliminary Steps

Before you begin, remove the following:

- Battery
- Top case
- Left speaker

Procedure

1. Disconnect the RJ-11 connector to the modem.
2. Disconnect the power cable on the DC-in board.
3. Remove the two screws.

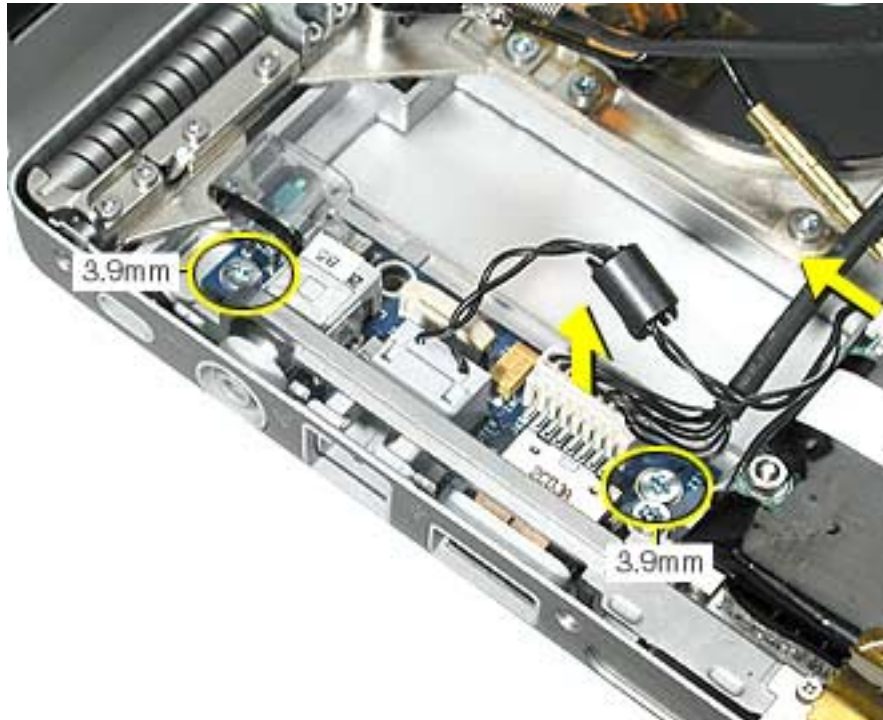

4. Insert a black stick under the DC-in board to help guide it out.

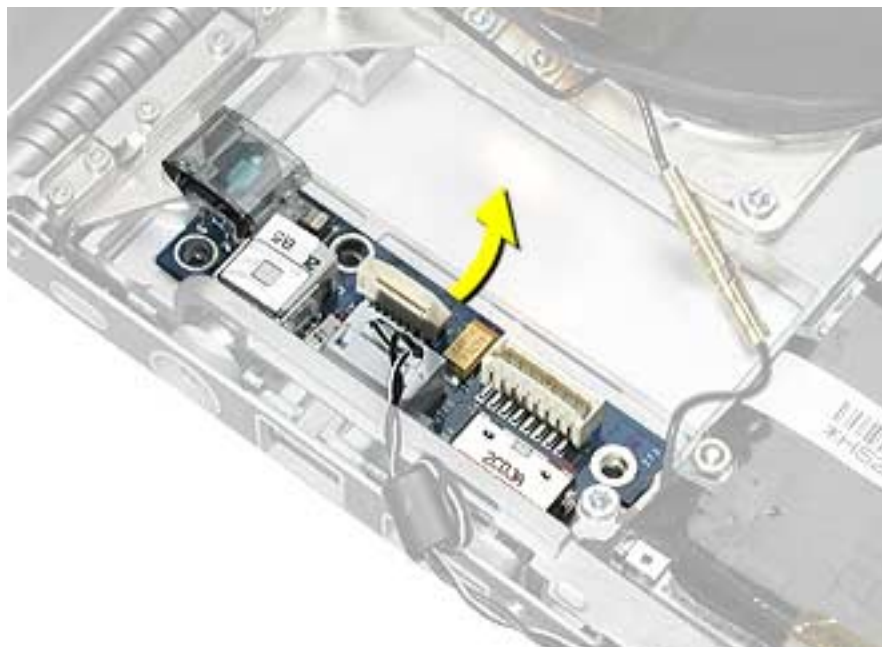

Replacement Note: Make sure that the replacement DC-in board includes the RJ-11 port and ambient light sensor cover. If not transfer them from the original board to the replacement board.

The RJ-11 port slides off the DC-in board but may be very tight. It may be helpful to pull on the port until it begins to move, then use a black stick to create leverage behind the port.

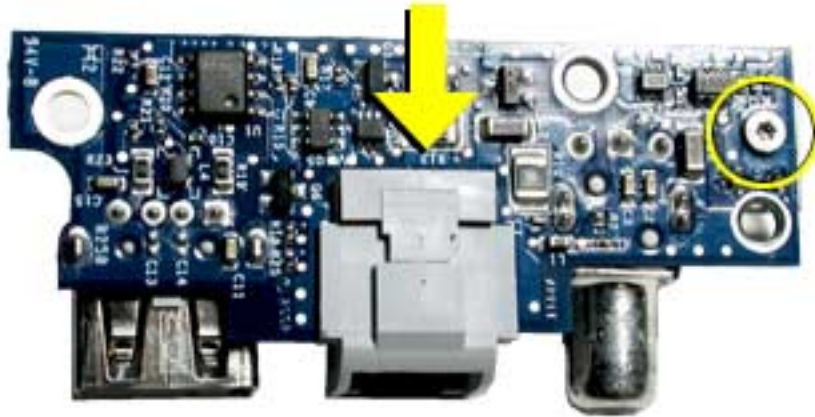

The ambient light sensor cover slides on and is attached with a screw from underneath the board.



5. Install the replacement DC-in board, and reassemble the computer.

Note: Insert a black stick into the USB port opening to guide the board into place.



6. Testing the computer should include using Bluetooth to connect to another computer. Check the function of the modem port, DC-in port and the left USB port.



Logic Board

Tools

This procedure requires the following tools:

- Torx T8 screwdriver (magnetized)
- X-Acto knife with a new flat-blade
- Black stick (or other nonconductive nylon or plastic flat-blade tool)
- Thermal Pad Kit (076-1033)
- T630 thermal gel (922-5929).

Note: To organize the screws you remove from the computer, use a tray with divided compartments (such as a plastic ice cube tray).

Part Location

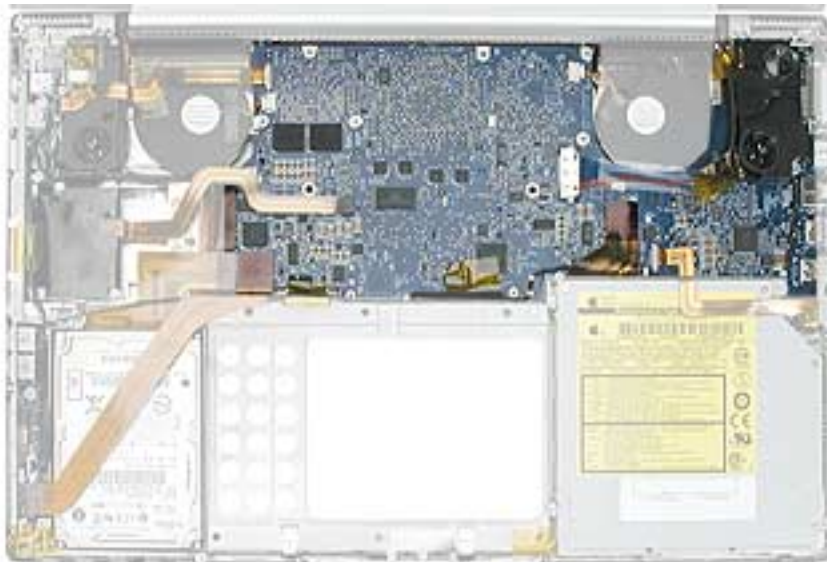

Preliminary Steps

Before you begin run the computer until warm (if possible) to help soften the thermal materials on the logic board, then shut it down and remove the following:

- Battery
- Top case
- SuperDrive
- Right speaker

Procedure

Warning: Flexing of the logic board can break solder joints to chips. To prevent damage to the board, guard against unnecessary flexing. Do not hold the board by the ports end or by the narrow neck at the fan cutout, as the board's weight can flex the board at this narrow point.

1. Turn the computer over. Disconnect the cables shown.

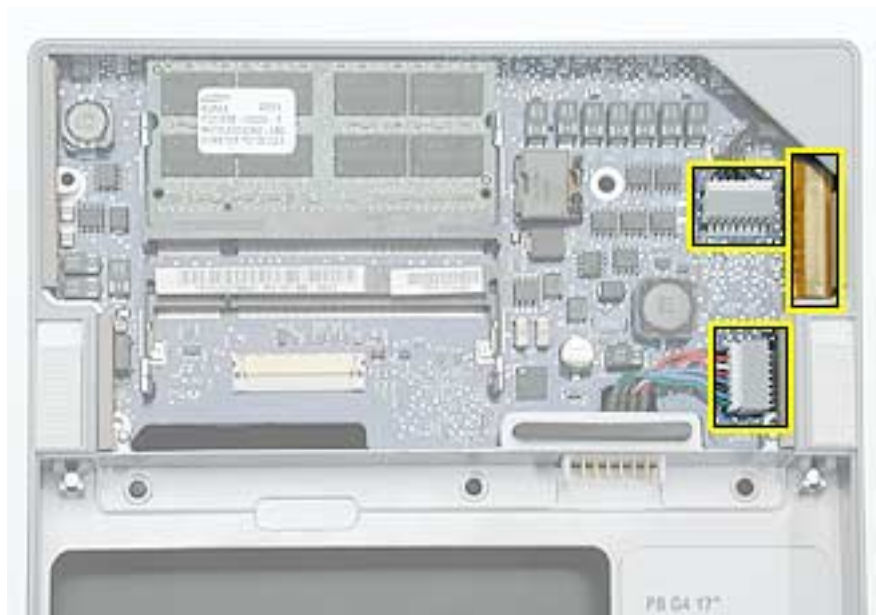

2. Turn the computer over. Disconnect the cables shown.



3. Remove the twelve screws.

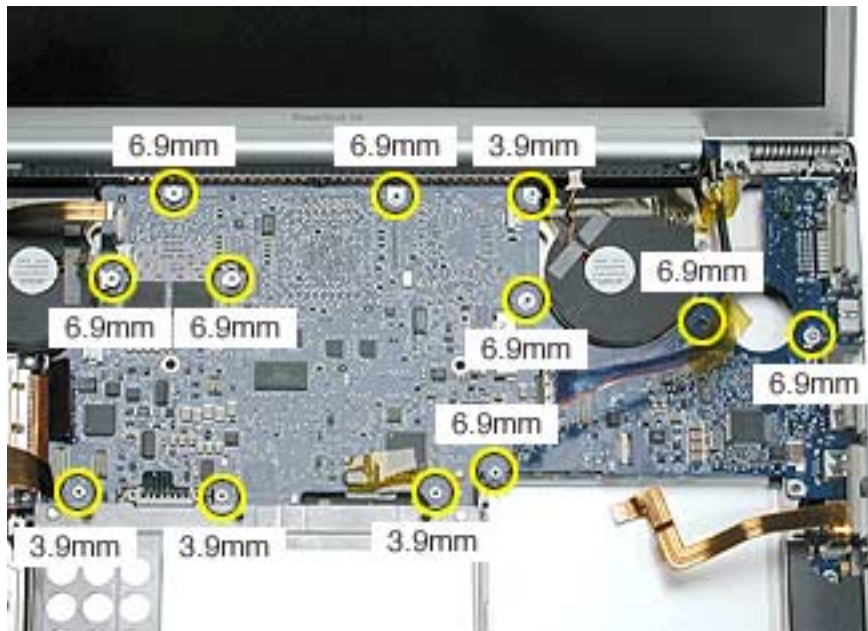

4. Lift the logic board from the left side and pivot along the port side.

Note: The thermal material on the bottom side of the board may make it difficult for the board to release (verify that all the screws have been removed). Apply slow constant pressure, avoid over flexing, until it releases.

Warning: Flexing the logic board can break solder joints to chips. Avoid unnecessary flexing especially at the narrow neck of the fan cutout.

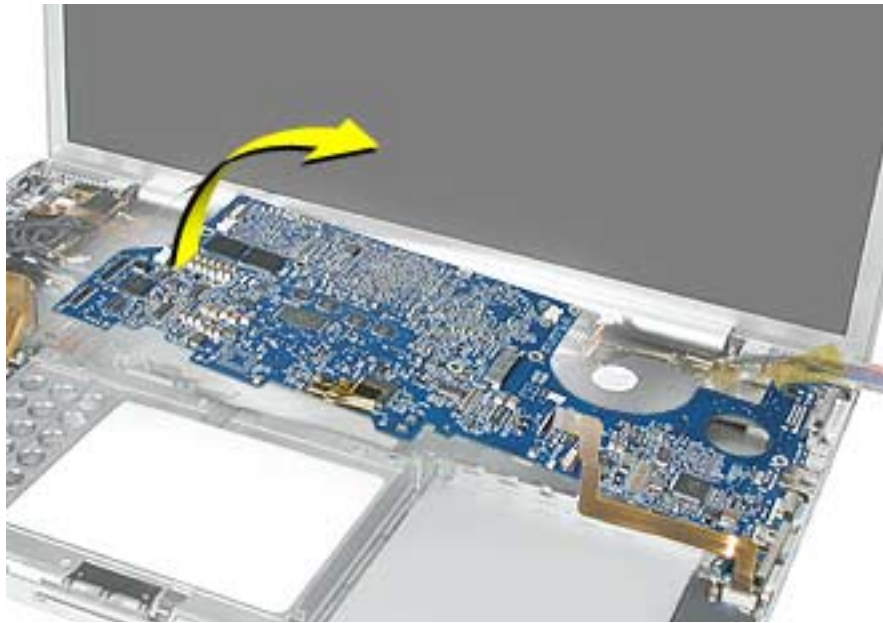

5. Carefully coax the port end of the board out of the port openings.

Note: The DVI connector may catch on the part of the frame shown here. Carefully maneuver it until it releases.

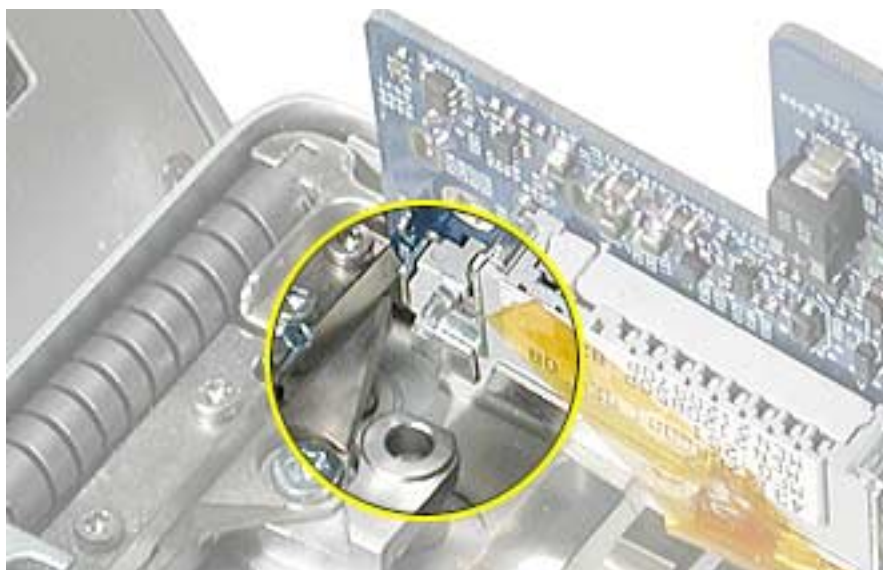

Replacement Procedure

Warning: Flexing of the logic board can break solder joints to chips. To prevent damage to the board, guard against unnecessary flexing. Do not hold the board by the ports end or by the narrow neck at the fan cutout, as the board's weight can flex the board at this narrow point.

1. Verify that the replacement logic board has EMI shields attached, as shown. If not, transfer the shields from the replaced board, or replace with a new shield kit.



-
2. On the back side of the logic board, remove the existing rectangular thermal pad covering two chips, shown below.

Important: If the pad is not on the board, check the underside of the top case and remove.

3. From the Thermal Pad Kit (076-1033) install the rectangular shaped pad over the two chips on the replacement logic board, where shown below.

Note: Avoid unnecessary contact with either side of the thermal pad as dirt and body oils reduce the thermal pad's conductivity.



4. Use a black stick to remove all the original thermal material on the heatsink at the locations shown below.
5. Vigorously clean remaining residue and adhesive with an alcohol pad.

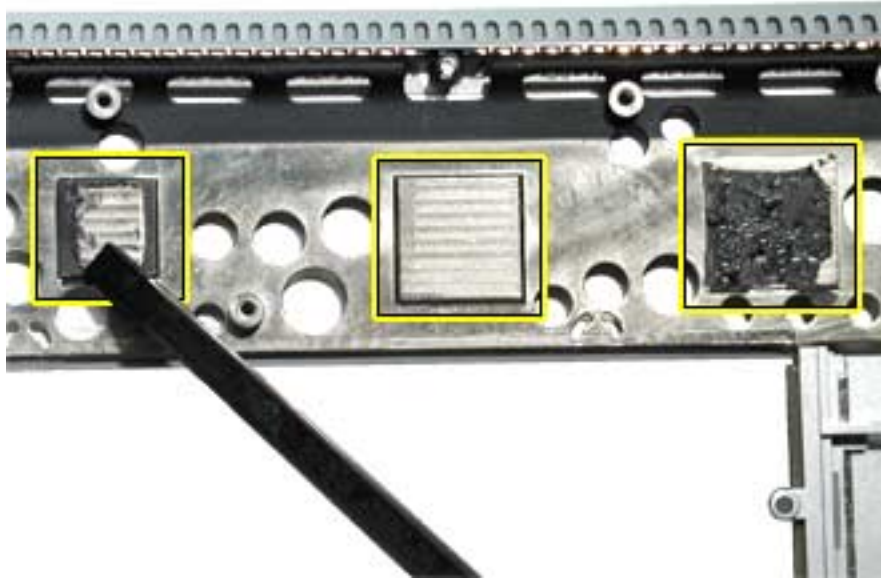

Warning: Whenever the logic board is separated from the heatsink, you must remove all existing thermal material and install new thermal material to the heatsink at the three locations shown above. Failure to do so can cause the computer to overheat and be damaged.

Important: If a replacement logic board comes with thermal pads installed, you will only need to install Thermal Gel (922-5929) to the center surface of the heatsink.

Note: Avoid unnecessary contact with thermal gel or either side of thermal pads as dirt and body oils reduce the thermal pad's conductivity.

6. From the Thermal Pad Kit (076-1033), center and install the square thermal pads on the heatsink as follows:
 - Smaller square pad on the left most mating surface
 - Larger square pad on the right most mating surface (if the kit includes two same-size pads, apply them, with the backing removed, one on top of the other as a double layer)

Note: To install a thermal pad, remove the protective backing from one side of the pad.

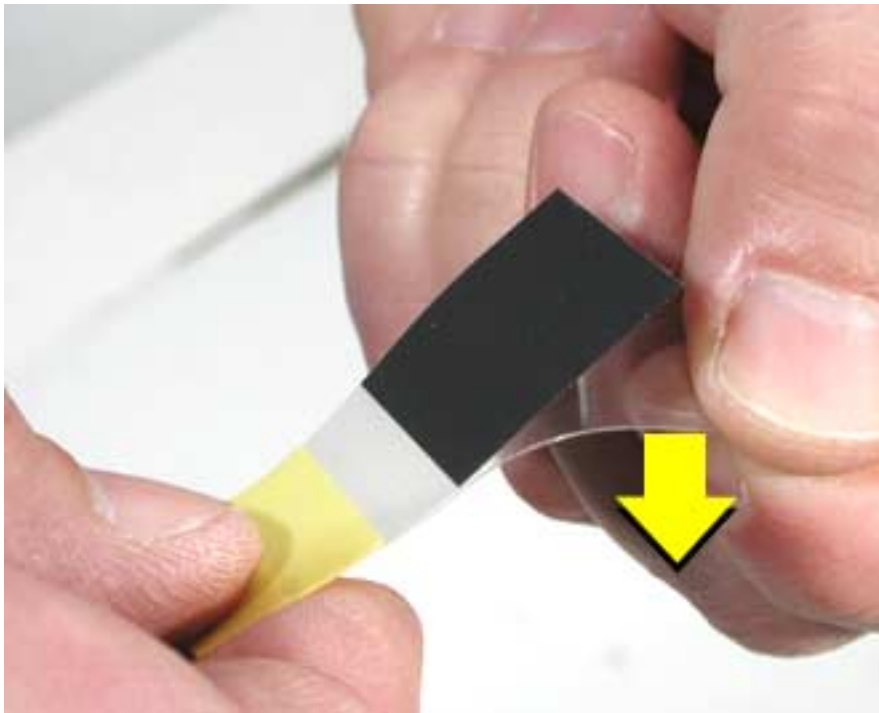

Center that side over the mating surface (raised surface) and evenly apply it, without air pockets, by lightly pressing on the protective backing of the other side.

Remove the remaining protective backing.

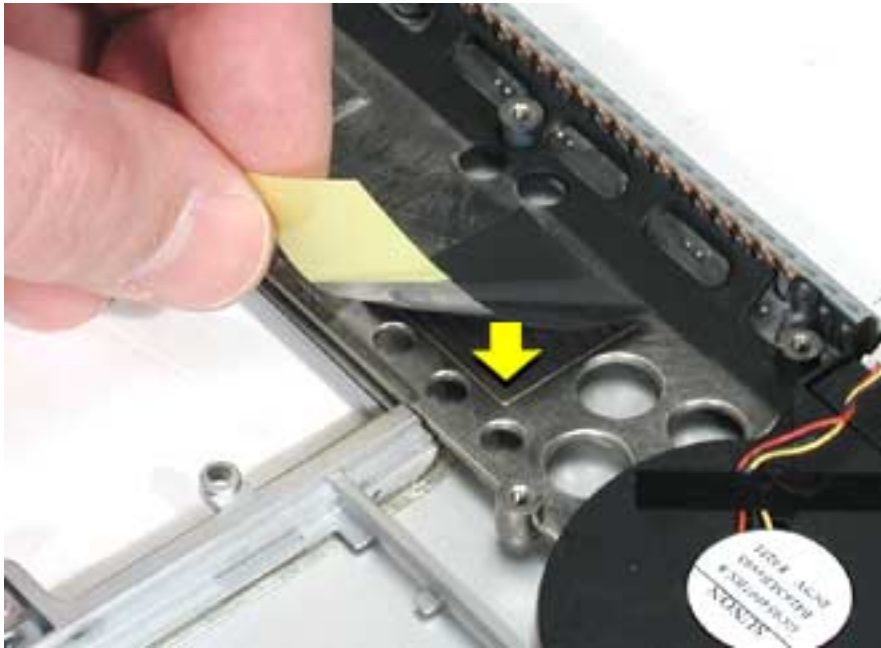

Important: With an X-Acto knife, trim any excess thermal pad material that extends beyond the mating surface, if necessary, to prevent it from touching holes in the heatsink.



7. Apply approximately 0.3 to 0.5 cubic centimeter (cc) of T630 thermal gel (922-5929) to the center of the center mating surface on the heatsink. (The 10 cc dispenser may be graduated in milliliters. **Note:** A milliliter (ml) is the same as a cubic centimeter (cc)).

Note: To apply the thermal gel from the 10 cubic centimeter (cc) dispenser, remove the end cap and push the plunger until the gel reaches the front opening. Note the position of the end of the plunger in the tube. Dispense the gel until the plunger end moves about 1/3 to 1/2 of 1 cc (ml). The plunger will move back slightly when pressure is released, so push it slightly beyond the amount to be dispensed.

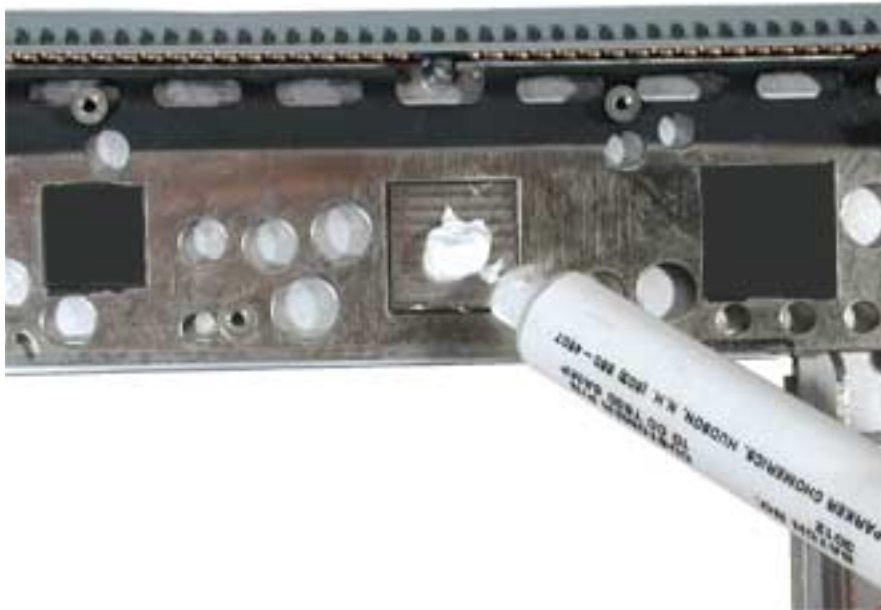

Note: After installing new thermal material, if you must briefly re-separate the logic board from the heatsink, it is OK to retain the same, new material, as long as they are not handled excessively.

8. If the logic board was removed to facilitate another procedure and will be reinstalled, also remove all the thermal material from the corresponding chips (shown below) in the same manner.

Important: Use extreme care not to damage the chips or logic board components.

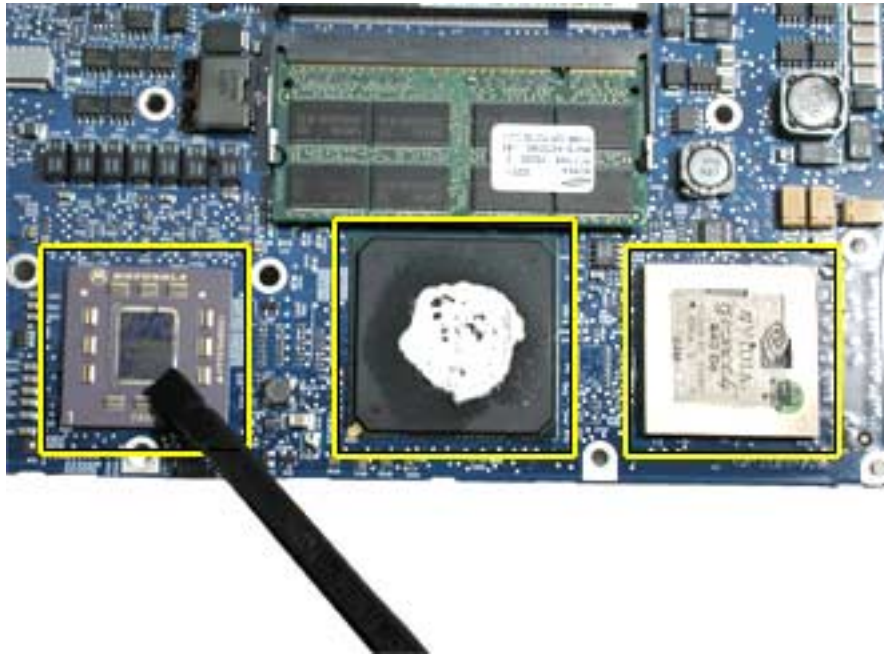

- To replace the logic board, guide the port side into the port openings on the bottom case. Align the S-video port first.

Note: Use care not to catch cables under the board as it is lowered into place.

- Attach the screws in the order shown.

Note: The three screws replaced first have “shoulders” and use wavy washers. Make sure that the washers do not get caught under the shoulder of the screw when installing.

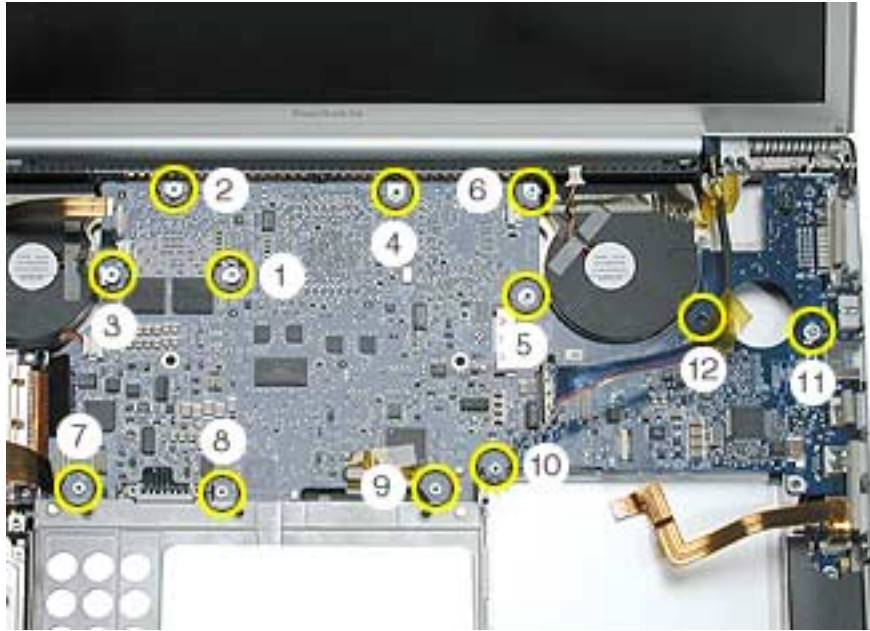

- Reassemble and test all ports, components and functions of the computer.



Display Panel Assembly

Tools

This procedure requires the following tools:

- Torx T6 screwdriver (magnetized)
- Black stick (or other nonconductive nylon or plastic flat-blade tool)
- 4 mm socket wrench (to install the pop-up spring torsion bar)

Part Location



Preliminary Steps

Before you begin, remove the following:

- Battery
- Top case

Procedure

Note: During these procedures, remove and reserve any Kapton tape for replacement, or replace with new tape during reinstallation.

1. Carefully disconnect the cable connectors shown.

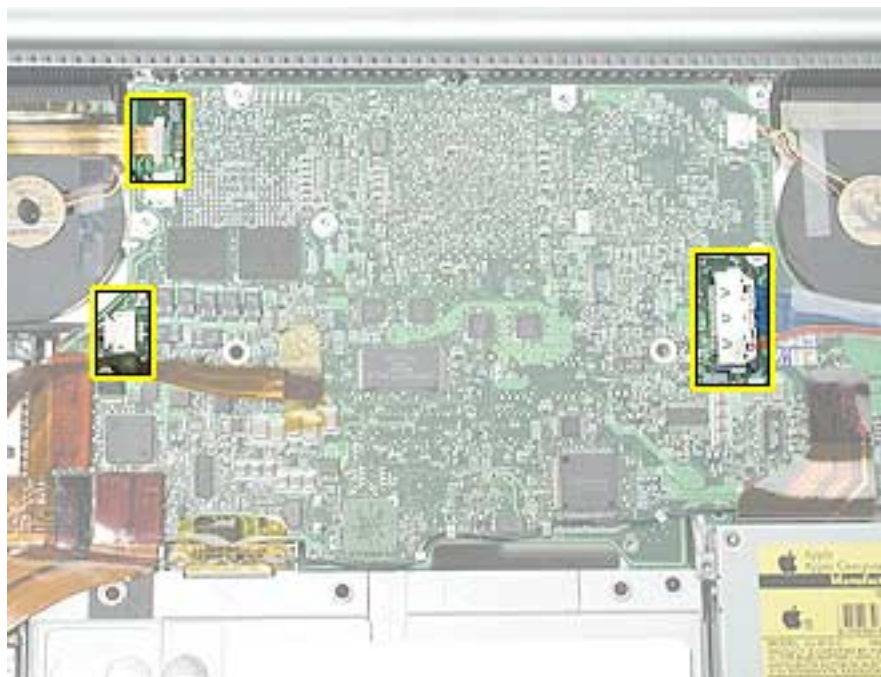

2. Pull out the coupling (joining the AirPort Extreme jumper and antenna cable) from the channel in the side of the left speaker. Grasp the coupling (not the wires) at both ends and pull to separate it at the middle.



3. Carefully disconnect the Bluetooth cable connector.

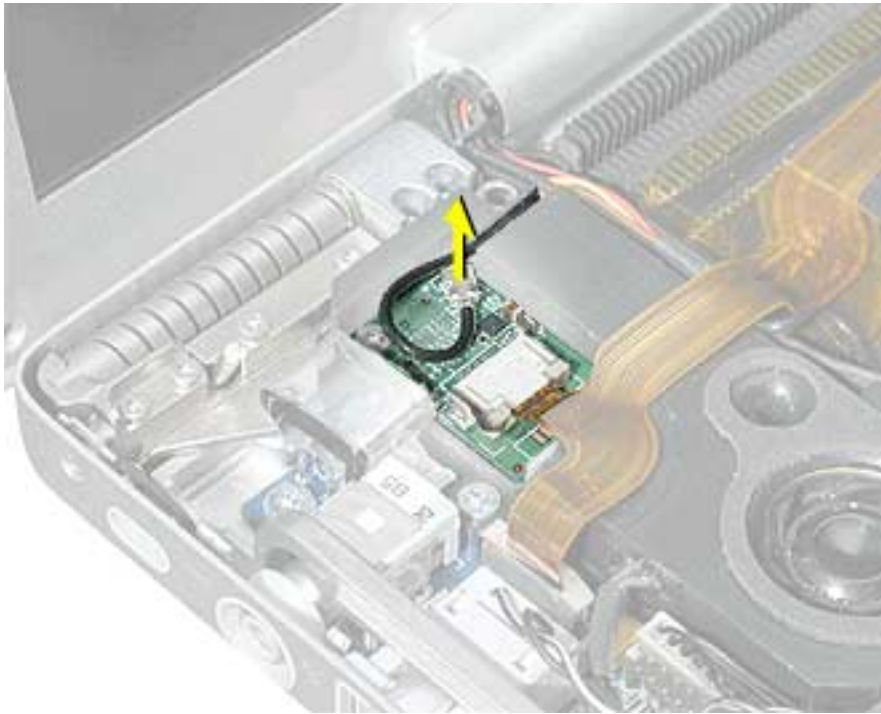

Important: During the following procedures, take care that the small parts and screws do not fall inside the computer.

4. Remove the screws that hold the wire brackets at both sides of the clutch barrel.

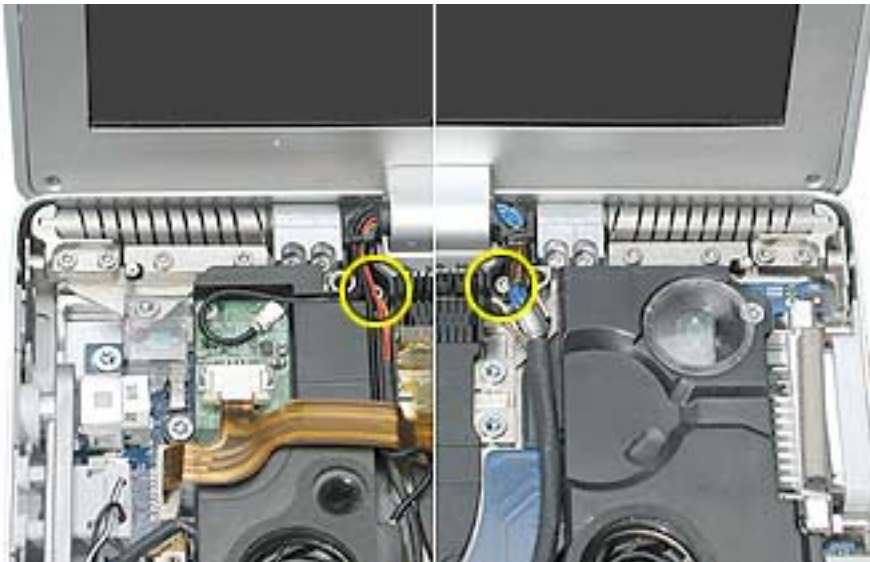

5. Move the display to a 90-degree angle and remove the two screws for the end caps of the clutch springs on each side.

Note: A 90-degree angle on the display helps to reduce the tension on the end pieces.

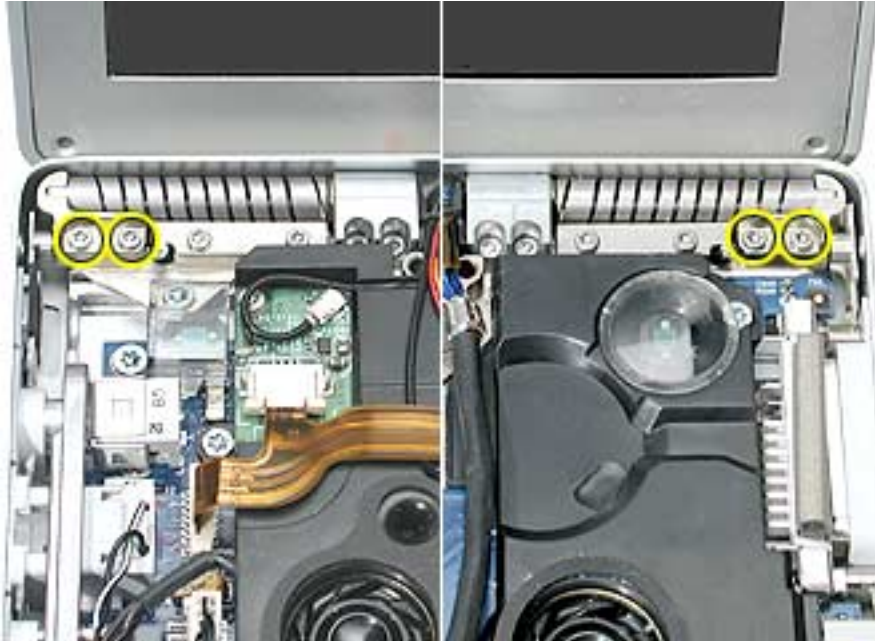

6. Remove the two clutch cleat screws on each side of the clutch barrel.

Important: Before removing the last screw, support the display so that it does not fall over.

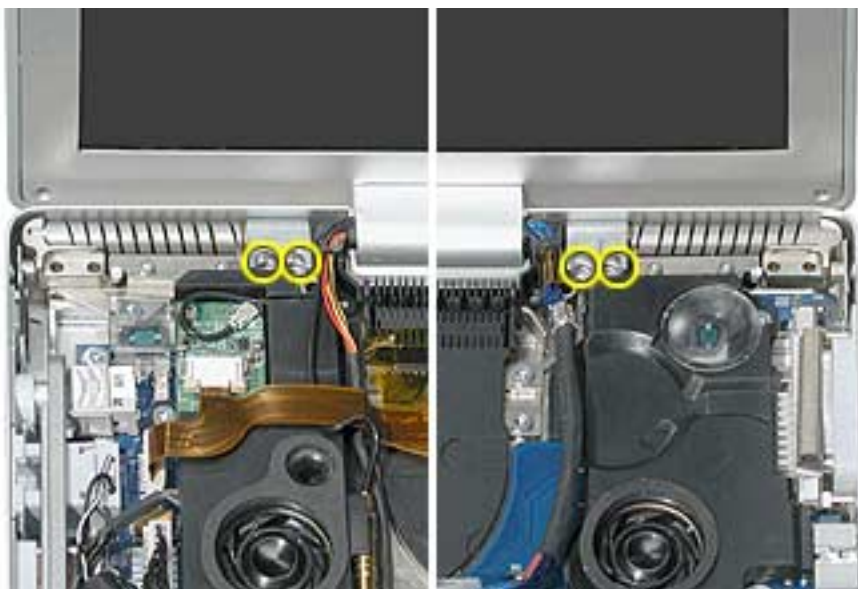

7. Lift off the display panel and clutch barrel assembly.



8. Remove the clutch spring end caps from both sides.



-
9. Remove the two screws and torsion bar on each side.



Replacement Procedure

1. To reinstall the display panel assembly, replace the end caps onto both clutch springs.



2. At the back corners of the bottom case assembly, push the pop-up spring pins all the way back, on both sides.

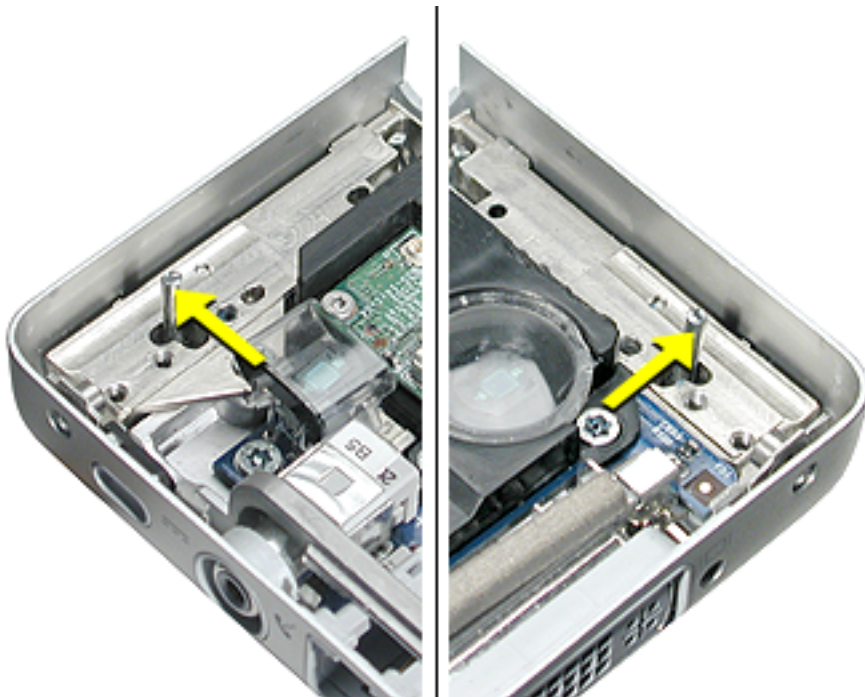

3. On the clutch, push the limit stop feet all the way back, on both sides.



4. Lower the display panel assembly straight down onto the bottom case assembly.



5. Verify that the limit stop feet, fit into the holes in front of the pop-up spring pins, on both sides.

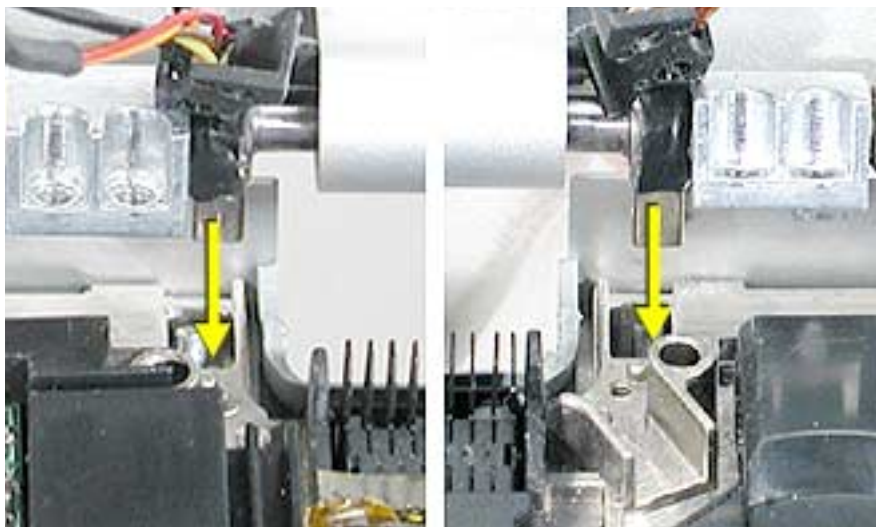

6. Install and tighten the screws for the clutch cleats, on both sides.

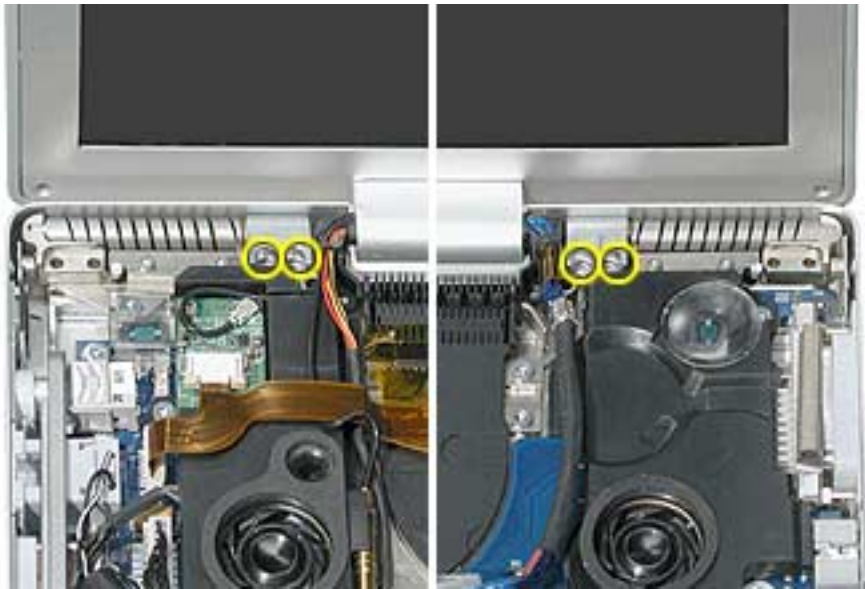

7. Hold the display at a 90-degree angle and install the end cap screws on both sides.



8. To install the pop-up torsion bars, insert the bar so that the notch is behind the pop-up spring pin and install the first screw furthest away from the pin.



9. Then, use a sturdy hex nut driver to press the torsion bar down flat (this places tension on the pop-up spring pin) and install the second screw. Do this for both sides.

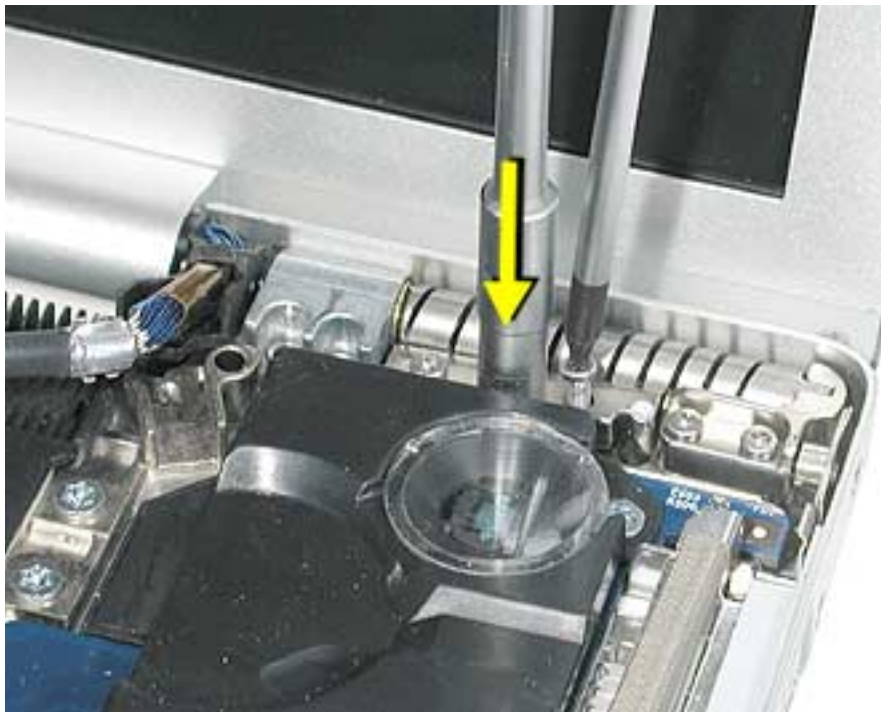

10. Replace the wire bracket screws on both sides.

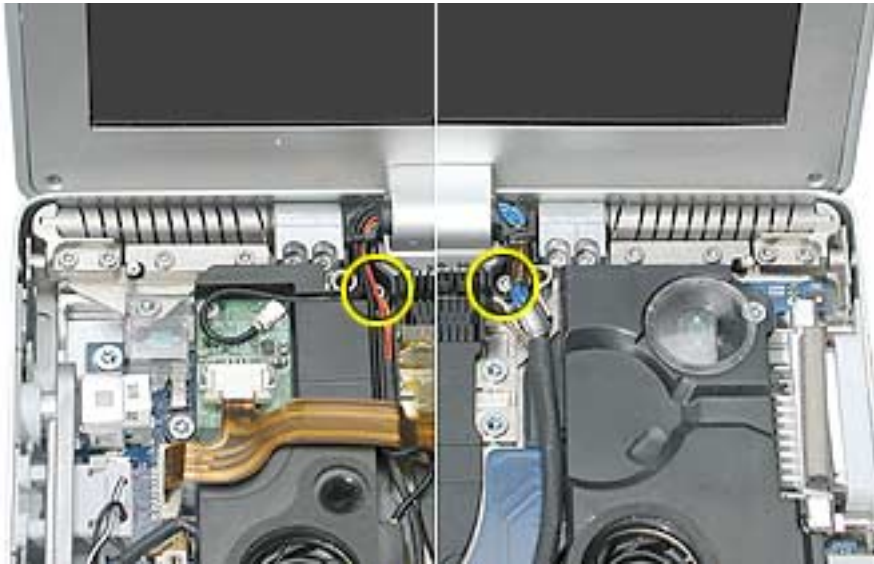

11. The left speaker has channels for Bluetooth, AirPort Extreme, inverter and the power cable from the DC-in board. Verify that the cables are routed and reconnected correctly.

12. Reconnect the DC-in board and Bluetooth flex cable to the logic board.



13. Verify that the LVDS cable's metal bead fits into the metal channel (rounded side up so that its teeth secure it) and that the cable is secured into the channel along the right speaker. Then, reconnect the LVDS cable and verify that it does not go over the fan.

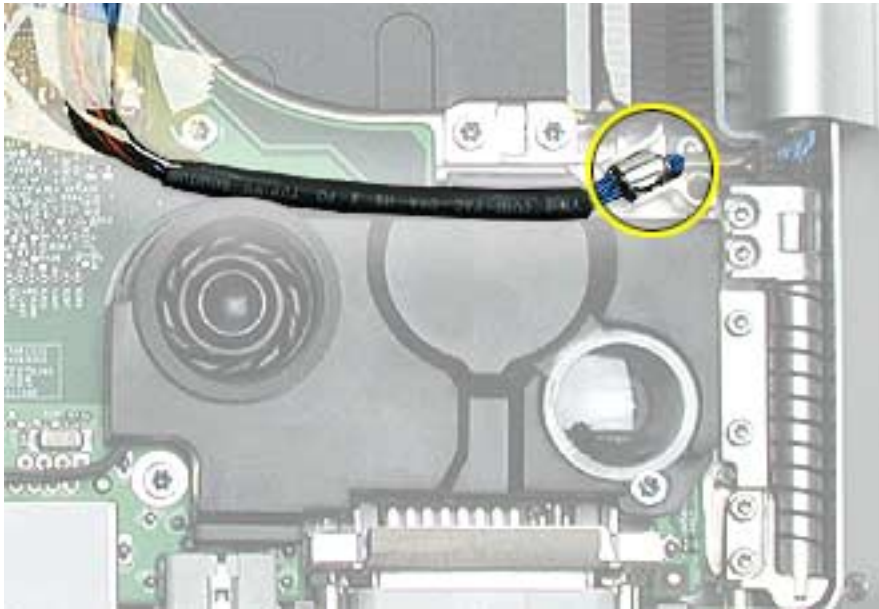

14. To verify that the pop-up mechanism was installed correctly, first make sure there are no wires or parts to interfere, then carefully close the display until it latches.

Push the display latch button and the display should pop-up slightly.

Note: If not, one or both limit stop feet, next to the clutch cleats, were not inserted correctly. Loosen the screws for the end caps and clutch cleats enough to push the feet into place and reinstall.



-
15. Reassemble and test the computer.
 16. Testing the computer should include the display panel. Use Bluetooth to connect to another computer and verify proper AirPort Extreme function. Check the function of the DC-in port and the left USB port.



Heatsink and Fan Assembly

Tools

This procedure requires the following tools:

- Torx T8 screwdriver (magnetized)

Part Location



Preliminary Steps

Before you begin, remove the following:

- Battery
- Top case
- Left and right speakers
- Logic board
- Display panel assembly

Procedure

Note: The Heatsink and fans are one assembly part.

1. Remove the screws and lift out the heatsink and fan assembly.



Important: Do not attempt to transfer fans from one heat sink to another. This can create acoustic issues.

Replacement Note: Make sure to clean existing thermal material from the logic board and apply new thermal material (see Logic Board chapter).

Important: If a replacement heatsink comes with thermal pads installed, you will only need to install Thermal Gel (922-5929) to the center mating surface of the heatsink.

2. Reassemble and test all ports, components and functions of the computer.



Bottom Case Assembly

Part Location



Preliminary Steps

Before you begin, remove the following:

- Battery
- Top case
- Hard drive
- Sound board
- SuperDrive
- Backup battery board
- Left and right speakers
- Modem
- PC card cage & AirPort Extreme assembly
- DC-in board
- Logic board
- Display panel assembly
- Heatsink and fan assembly

Procedure

When all preliminary steps are performed, the bottom case is the part that remains.

Verify that the following items are on the replacement bottom case, if not, transfer them from the bottom case being replaced, or install new:

- EMI shields
- Rubber gasket
- Battery connector assembly

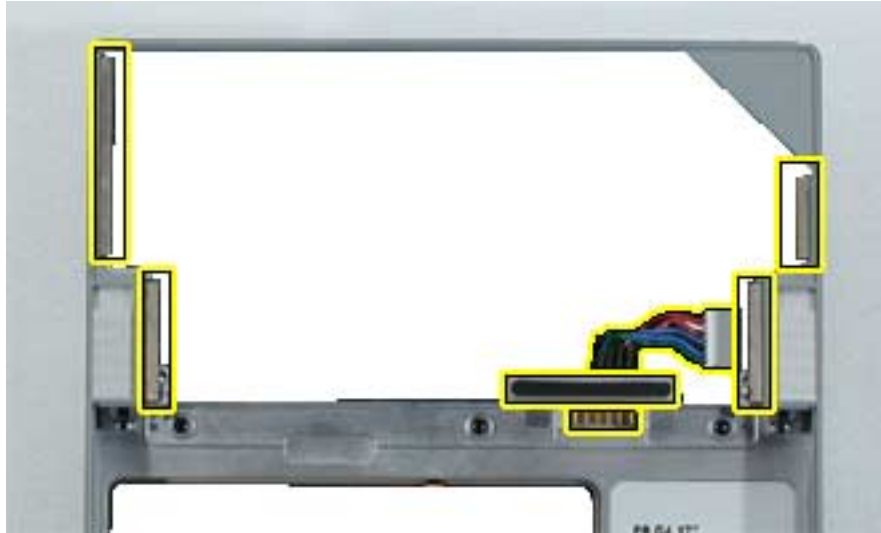

1. Reassemble and test all ports, components and functions of the computer, including battery operation.



Troubleshooting
PowerBook G4 (17-inch)



General Information

Wire and Flex Cables

With the very thin enclosure design and dispersed circuit board, a large number of flex cables are used in this computer. In addition, there are a variety of wire cable harnesses as well. Many of these cables carry multiple types of signals. In the case of the DC-in board flex cable; the cable is forked with one path going to the Bluetooth board and the other to the DC-in board.

Here is a list of the cables and the signals that run across them. If you notice a group of functions not working, it is likely that the cable is not properly inserted or the connector is damaged.

Cable or Flex Cable Name	Signal(s) Running Through It
Bluetooth antenna cable (to diversity board in display panel assembly)	Bluetooth radio signal
AirPort Extreme antenna cable (to diversity board in display panel assembly)	AirPort radio signal
AirPort Extreme antenna jumper	AirPort radio signal
AirPort Extreme flex cable	AirPort data / control
Sound board flex cable	Sound in Sound out Internal speaker Internal microphone Sleep light
Speaker assembly cable	Left speaker Right speaker Internal microphone
DC-in board cable (to logic board)	Power to system and main battery
DC-in board flex cable	Bluetooth data Left USB connector Left ambient light sensor
Fan (left) cable (to logic board)	Power/control for left fan

Cable or Flex Cable Name	Signal(s) Running Through It
Fan (right) cable (to logic board)	Power/control for right fan
Hard drive flex cable (to logic board)	Hard drive control, data, and power
Inverter cable (to inverter board in display panel assembly)	High voltage for backlight
Inverter cable (to logic board)	Display backlight control
Keyboard backlight cable (on top case)	Power to keyboard backlight LEDs
Keyboard flex cable	Keyboard data and status lines
LVDS cable (from display panel assembly)	Video data to display panel
Main battery cable	Connects main battery to logic board
Modem flex cable (to logic board)	Modem control and data
PC Card cage flex cable (to logic board)	PC card data and power
Power Button cable	Power-on signal
RJ-11 cable (to modem)	Analog phone signal
Sleep LED cable (to sound board)	Power to sleep LED
SuperDrive flex cable (to logic board)	SuperDrive data and control signals
Top case flex cable (to logic board)	Keyboard data and status Power-on signal Power to keyboard backlight LEDs Trackpad data and power
Trackpad flex cable	Trackpad data and power

Potential flex cable and connector issues.

ZIF connector locking Bar

The locking bar holds the flex cable into the connector. The connector will not work properly if any of the following situations exist:

- The locking bar is not completely pushed into the socket on both sides.

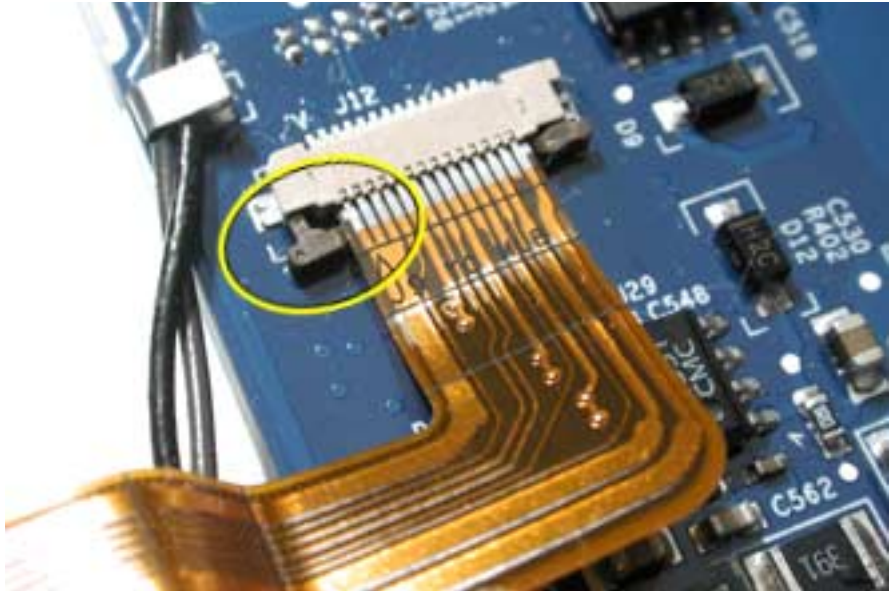

- The locking bar is broken or missing.

Important: In this case the board must be replaced.

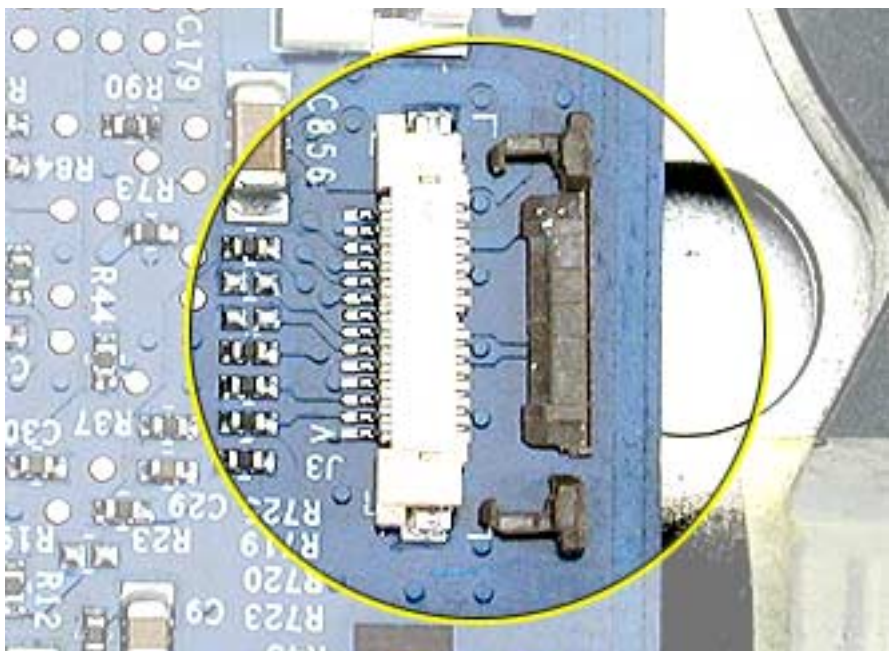

The cable is not secured straight.

Make sure that the alignment mark, if present, or metal edge of the contacts run parallel to the connector. If the flex cable is inserted crooked, some signals may not be connected or signals may short together.

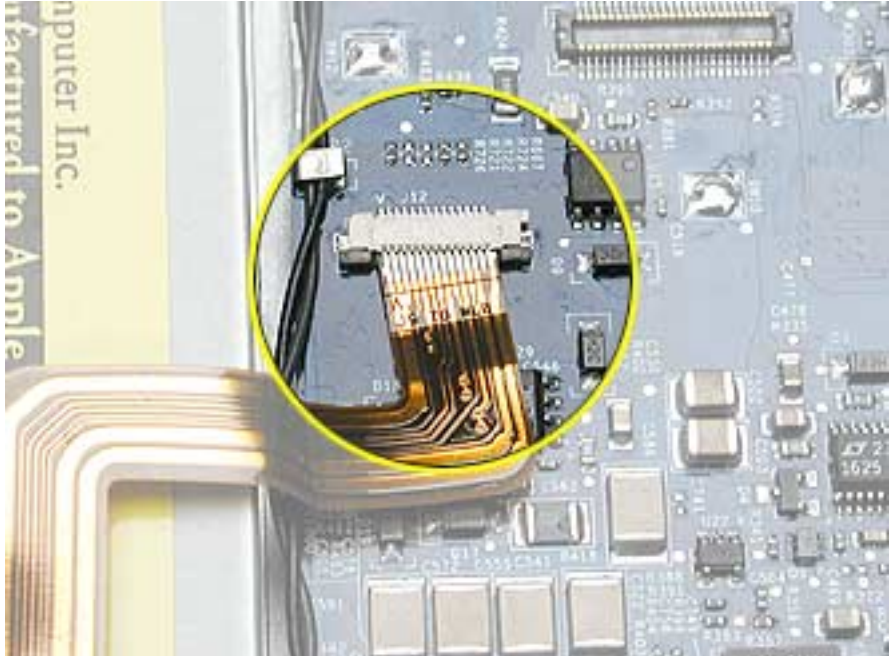

Broken connectors on the flex cable

Some flex cables have connector plugs or sockets attached at their ends. These connectors are fragile and their connections can easily break away from the flex cable if the connector end is bent or too much force is used when disconnecting, making them unusable. Some of these flex cable connectors may have a tab or pull loop to help remove them. Those without can be removed by carefully rocking them from side to side.

Important: Do not bend the connector ends of these flex cables or pull up along the narrow end of the connector.

Check to make sure that no part of the connector has separated from the cable.

Cables nicked or crimped

For cables in the bottom case assembly routed along the front left edge, left side and display clutch areas, check whether the wire insulation has been nicked (exposing bare metal), severed or crimped. If wire insulation has been nicked but the wires are still intact, insulate it with Kapton tape.



Hardware Troubleshooting Tools and Tips

Apple Hardware Test 2.0.1 (AHT)

Starting with the PowerBook G4 (17-inch), the Apple Hardware Test software will be incorporated into the Software Install and Restore DVD. There is no separate CD for this diagnostic.

Previously, the C key was held down to boot into the diagnostics. With the combined DVD, this action will boot into the software restore section of the disk. In order to access the AHT on the DVD follow these steps:

1. Insert the DVD named "PowerBook G4 17 inch Software Install and Restore" that came with your computer.
2. Hold down the Option key and restart the computer.
3. Click Apple Hardware Test volume in the startup manager.



4. Click the arrow that points to the right.
5. Follow the on-screen instructions.

Note: Apple Hardware Test 2.0.1 is not backwards compatible with PowerBook computers prior to the PowerBook G4 (1Ghz/867Mhz).

Apple Service Diagnostic (ASD)

MacTest Pro software does not work on this computer since the PowerBook G4 (17-inch) is a Mac OS X only system. Apple System Diagnostic (ASD) is the replacement and can be downloaded from Knowledge Base article 112125: Service Diagnostics Matrix.

Important: ASD is not compatible with PowerBook computers prior to the PowerBook G4 (1GHz/867MHz).

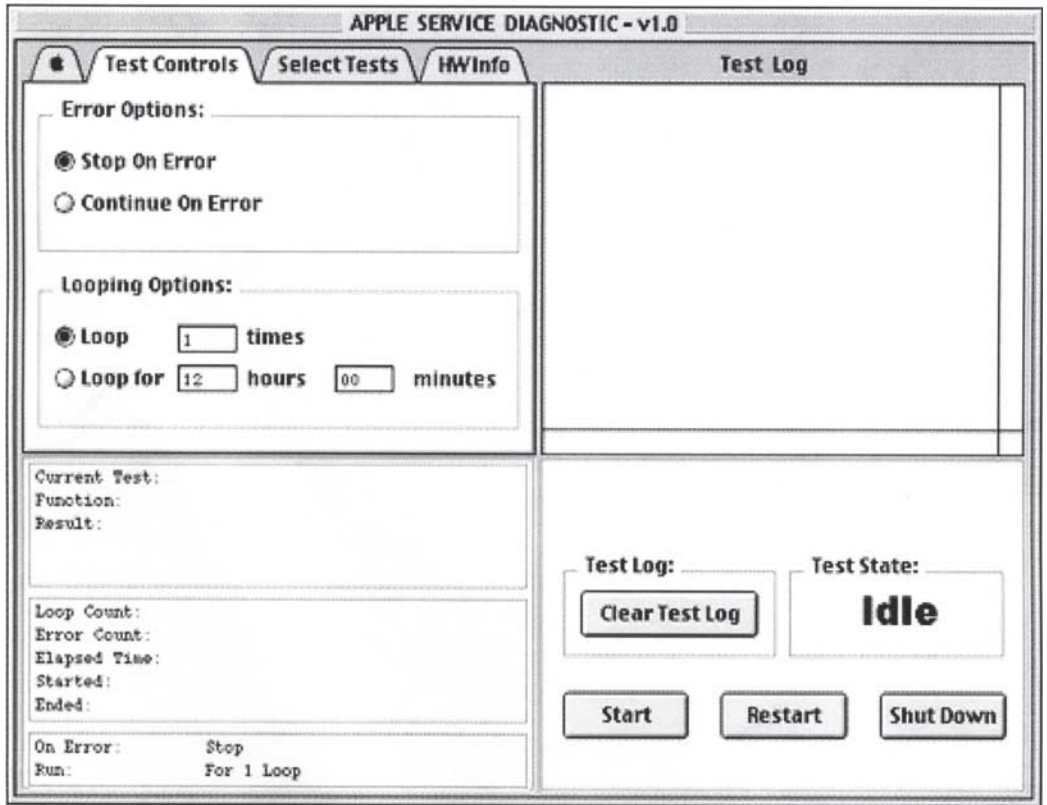

Apple Service Diagnostic Main screen

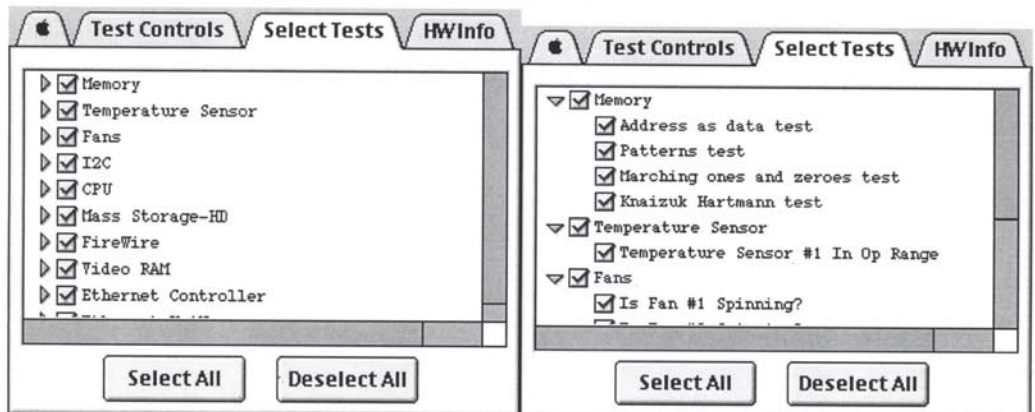

Apple Service Diagnostic Select test tab

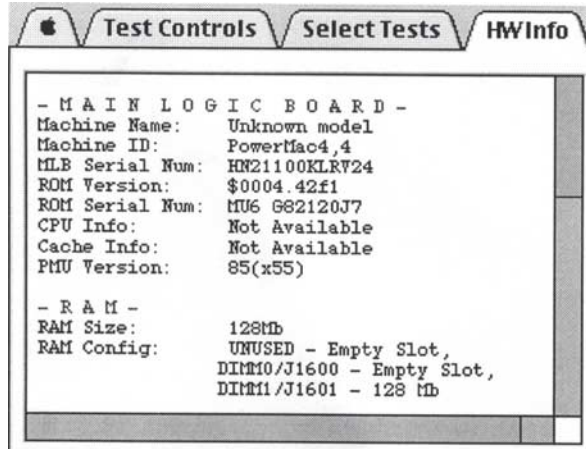

Apple Service Diagnostic Hardware info tab

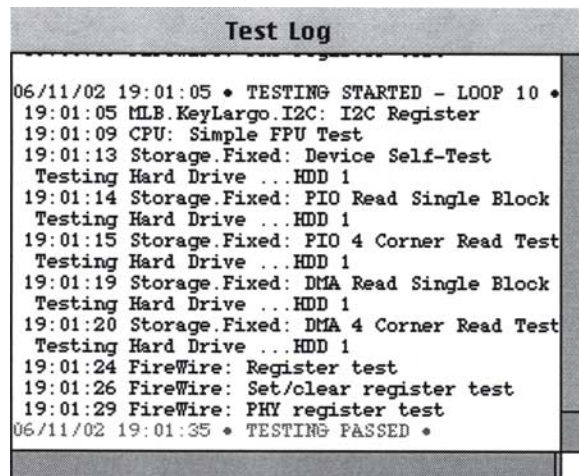

Apple Service Diagnostic Test log tab

Resetting the Power Manager Unit (PMU)

The PMU reset button has been removed from the logic board. Use the following key combination procedure or the PMU Reset pad (see PMU NMI and PMU Reset pads on logic board, below).

1. If the computer is on, turn it off.
2. Reset the power manager by simultaneously pressing and then releasing Shift-Control-Option-power button. Do not press the fn (Function) key while using this combination of keystrokes.
3. Wait 5 seconds.
4. Press the power button to restart the computer.

Power-on pads on logic board

With the top case removed, the power-on button is disconnected. Instead of having to reconnect the top case to turn on the system, there are two pads on the logic board when shorted together (with a tool like the head of a flat blade screwdriver) is the equivalent to pushing the power-on button.

These pads are located about 5cm left of the back left corner of the optical drive, 1-1/2cm above the notch for the top case flex cable. It is marked POWER BUTTON. The pads are separated with a vertical white line.

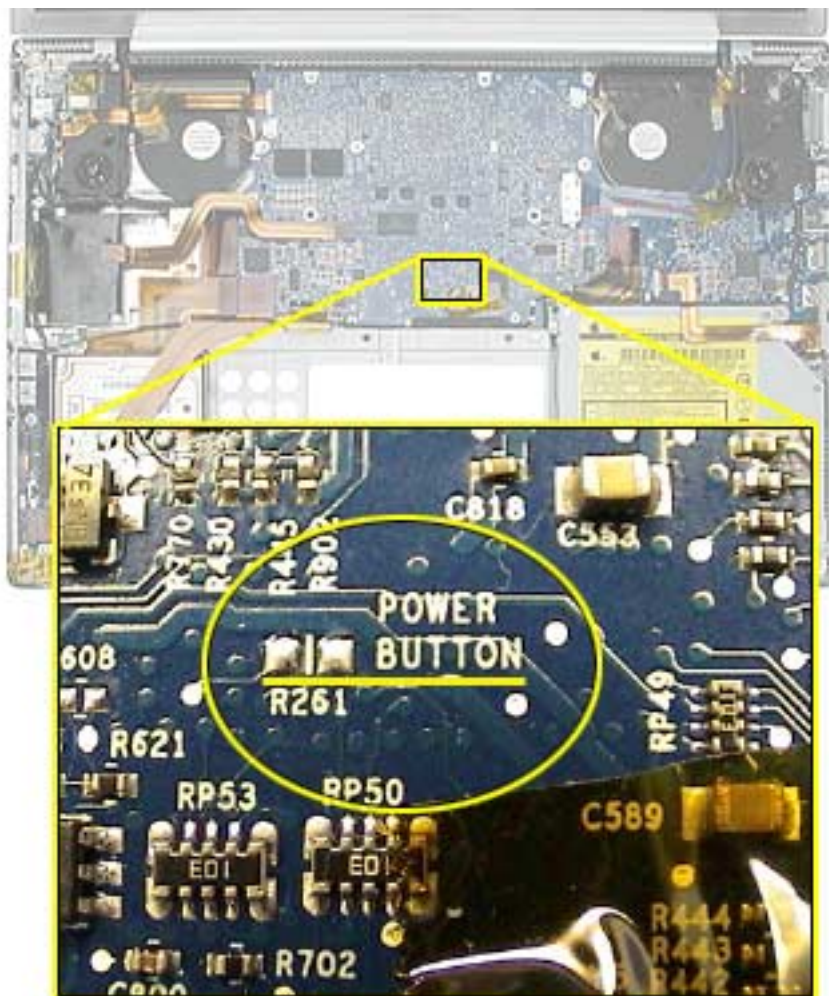

PMU NMI and PMU Reset pads on logic board

In addition to the power-on button pads on the logic board, there are pads for PMU NMI and PMU reset. These buttons work when their pads are shorted together (with a tool like the head of a flat blade screwdriver). They are marked PMU NMI and PMU RESET. The pads are separated with a white horizontal line between the pads.

These pads are located about 1cm left of the back left corner of the optical drive.

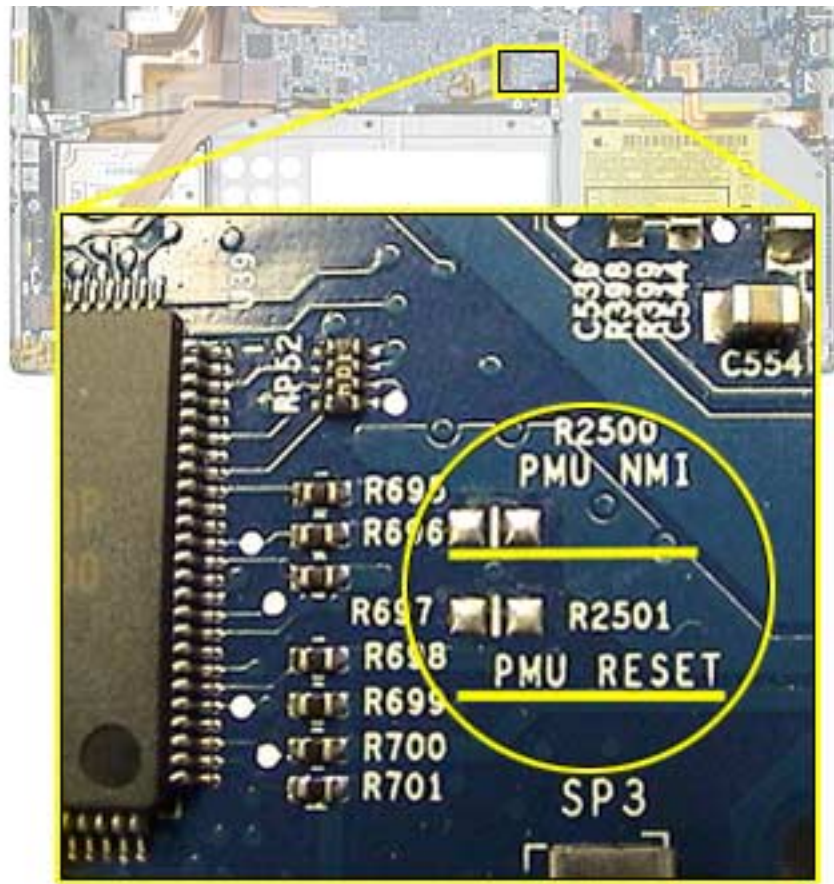

Caps lock LED power check

There are situations when the system is giving indications that it is shut down (no hard drive access, screen is dark, no fan, and so on). However, the logic board may still be running. In this case, the logic board is drawing power and generating heat.

Warning: In this situation, if the computer is put in an enclosed environment like a carrying bag, the computer can overheat.

Check this situation by pressing the caps lock key. If the LED glows, the PMU is running on the logic board. After pressing the caps lock key and perhaps other methods of waking it up fails, hold the power button down for six seconds to force a shut down of the computer. Restart the system to check if it boots up normally.

Software Troubleshooting Tips and Tools

Mac OS X only

Starting with the PowerBook G4 (17-inch), the system will no longer boot into Mac OS 9. Mac OS 9 applications can still be used, but only in the Mac OS X classic mode.

In locations such as the Startup Disk system preference pane, a Mac OS 9 folder will not show up as an option.

Login window and account

Mac OS X requires at least one user account to be established. This is the Administrator's account. By default, the Accounts system preference pane has the "Log in automatically [Admin's name]" check. This automatic login setting allows the system to boot into the Finder without having a log-in prompt.

However, if this box is not checked, you will need a password to get to the Finder. In addition, you will need to create a user account after you re-install system software.

Customer forgot password

If the customer forgot the password for the computer:

1. Insert the Software Install and Restore DVD.
2. Restart the computer while holding down the C key on the keyboard.
3. When the installer appears, choose Reset Password from the Installer menu.
4. Follow the on-screen instructions.

Safe Mode

The Mac OS X that shipped with the PowerBook G4 (17-inch), has a new startup state called Safe Mode.

Safe Mode is the state Mac OS X is in after a Safe Boot. A Safe Boot is a special way to start Mac OS X when troubleshooting. Starting up into Safe Mode does three things to simplify the startup and operation of your computer:

1. It forces a directory check of the startup (boot) volume. It is identical to using Disk Utility's Repair Disk or the `fsck -fy` terminal command.
2. It loads only required kernel extensions (some of the items in `/System/Library/Extensions`).
3. It runs only Apple-installed startup items (some of the items in `/Library/Startup Items` and `/System/Library/Startup items` - and different than login items).

Taken together, these changes can work around issues caused by software or directory damage on the startup volume.

To start up into Safe Mode (to Safe Boot), do this:

1. Be sure the computer is shut down.
2. Press the power button.
3. Immediately after you hear the startup tone, press and hold the Shift key.

Note: The Shift key should be held as soon as possible after the startup tone but not before.

4. Release the Shift key when you see the screen the gray Apple and progress indicator (looks like a spinning gear).

During the startup, you will see "Safe Boot" on the Mac OS X startup screen (shown below). To leave Safe Mode, restart the computer normally, without holding any keys during startup.



Knowledge Base Articles

These troubleshooting articles can be searched from <http://www.apple.com/support>.

106692 Mac OS X: Troubleshooting Installation and Software Updates

106693 Mac OS X: Troubleshooting Installation From CD-ROM



Hardware Symptom Charts

How to Use the Symptom Charts

The Symptom Charts included in this chapter will help you diagnose specific symptoms related to the product.

The steps to solve a symptom are listed sequentially. You might not need to perform every step before the symptom is solved. Start with the first step, and then test for the symptom. If the symptom persists, replace any modules you removed, go to the next step, and test again. Continue down the list until the symptom is solved.

Power Adapter Note

The system was designed to use the Apple 65-Watt Portable Power Adapter that came with your computer. The previous 45-Watt Apple power adapter for PowerBooks is plug compatible, but it may not provide sufficient power during some activities and power may be drawn temporarily from the battery. You can identify the Apple 65W Power Adapter by its markings (see photo).



Under low battery or no battery situations, the 45 watt power adapter may not be able to provide enough power to properly support the system.

Although you may have used the 45 watt adapter with a PowerBook G4 (1Ghz/867Mhz) without trouble, the peak power requirements of the PowerBook G4 (17-inch) is much higher and will have a higher chance of encounter compatibility issues.

Startup

The computer will not power on (no fan movement, hard drive spin up and display is not lit)

1. Remove any connected peripherals and eject any PC card.
2. Check that the battery has enough charge to start the computer by pressing the button next to the LEDs on the battery. At least one LED must light solid (not flashing).
3. Connect a known-good Apple 65W Portable Power Adapter (661-1798) and power cord or plug to a known-good power outlet; make sure the DC plug is firmly inserted. The DC plug should light up, if not, replace DC-in board.

Important: The Apple 65W Portable Power Adapter is highly recommended to be used with the PowerBook G4 (17-inch) computer. The adapters can be identified by 65W in the name and markings, and the metal securing-stud on the plug connector. Although previous 45W power adapters (see Knowledge Base article 88231 PowerBook and iBook: Apple Power Adapter) are plug compatible with the PowerBook G4 (17-inch), it may not provide sufficient power during some activities and power may be drawn temporarily from the battery.

4. Try powering up without the battery installed (only works with 65W power adapter).
5. Perform the keyboard PMU reset procedure described in the Troubleshooting Aid section.

Warning: Resetting the power manager will permanently remove a RAM disk, if present, and all of its contents. You will also need to reset the date and time (using the Date & Time system preference pane).

6. Press Caps Lock key to see if key light comes on. If it does, hold power button down for six seconds to shut down the computer and restart.
7. If it still doesn't start, verify power button cable is connected properly to top case flex cable assembly and that the flex cable is connected correctly to the logic board, if power button is not functioning correctly or damaged, replace the top case.
8. Disconnect keyboard completely. Inspect connectors. Restart with keyboard disconnected.
9. Remove any additional RAM.
10. Remove AirPort Extreme Card.
11. Verify DC-in board cable is securely connected.
12. Try known-good DC-in board.
13. Replace logic board.

Memory error message “The built-in memory test has detected an error” appears on the screen

1. Run Apple Service Diagnostic Test. Note: If the failure is intermittent, run Apple Service Diagnostic Test in loop mode (check looping options under Test Controls tab and select only the RAM test under the Select Tests tab) for an extended time to test the memory.
2. If the test can't find the memory or finds bad memory, inspect the bad DIMM. Verify proper memory is being used. The PowerBook G4 (17-inch) uses PC2700 (also called DDR333) DDR SDRAM SO-DIMMs with a maximum height of 1.25-inch (30 mm). If improper memory is being used replace it. Otherwise, try reseating the DIMM and retest. If still reported as bad, replace it.
3. Check the memory connector for damage (retention arms broken, connectors bent or missing, connector lifted from logic board). If damage is detected replace the logic board.

**Blue screen appears (a spinning disc cursor may also be visible),
Prohibitory Sign appears,
Restart dialog box appears (Mac OS X 10.2 kernel panic window), or
Gray screen during startup**



Prohibitory Sign

You need to restart your computer. Hold down the Power button for several seconds or press the Restart button.

Veillez redémarrer votre ordinateur. Maintenez la touche de démarrage enfoncée pendant plusieurs secondes ou bien appuyez sur le bouton de réinitialisation.

Sie müssen Ihren Computer neu starten. Halten Sie dazu die Einschalttaste einige Sekunden gedrückt oder drücken Sie die Neustart-Taste.

コンピュータを再起動する必要があります。パワーボタンを数秒間押し続けるか、リセットボタンを押してください。

Kernel Panic dialog box

1. Make sure all external devices are disconnected and any PC card ejected. If kernel panic goes away, troubleshoot the external device by reconnecting each device until the panic occurs.
2. If there are two RAM cards installed in the expansion slots, remove the top card and restart.
 - If symptom repeats, replace bottom card with known-good RAM card.
 - If symptom does not repeat, replace top RAM card with known-good RAM card and restart.

For assistance in software troubleshooting, go to Knowledge Base article 106464: Mac OS X: Troubleshooting a Startup Issue.

Flashing question mark appears on the screen

Note: This system will only boot the Mac OS X system that shipped with this computer or later. It does not support booting into Mac OS 9.

1. Start up from the software install and restore DVD that came with the computer (hold down the "C" key during restart).
2. When the Installer opens, from the Installer menu, select Open Disk Utility.
3. When the Disk Utility opens, on the left hand side, all disk and volumes are listed. If you don't see the internal hard drive, the system is not recognizing it. Skip to step 4. Otherwise, select the First Aid tab and follow the instructions to verify the hard disk, and repair if needed. Restart the computer.
4. If the hard drive is not recognized, check the hard drive flex cable for damaged connectors, and if bad replace the hard drive flex cable.
5. Reseat the hard drive flex cable. If still not recognized, replace the hard drive.

Important: If the computer is under warranty and data recovery is required, refer to Knowledge Base article 31077: DriveSavers: Hard Drive Data Recovery & Warranty Implications, for important information.

6. Reinstall system software using the software install and restore disc.

Note: Don't forget to install both the Mac OS X and Applications and Classic software. This operation is completed with two separate installs. Restore disc images are available at <http://service.info.apple.com>. Select "Disc Images."

Computer begins to power up, the fan and hard drive are spinning, pressing caps lock key and LED turns on, but there is no startup chime or video

1. Reset the power manager by using the keyboard sequence. Wait five seconds before continuing. Press the power button to start the computer.

Warning: Resetting the power manager will permanently remove a RAM disk, if present, and all of its contents. You will also need to reset the date and time (using the Date & Time system preferences pane).

2. Replace the logic board.

System shuts down intermittently

Important: This issue can be a result of not using the 65W power adapter with the PowerBook G4 (17-inch) computers. Confirm with the customer which adapter they were using when having this problem. The adapter can be identified by 65W in the name and markings, and the metal securing-stud on the plug connector.

1. Disconnect all external peripherals and eject any PC card.
2. Make sure a known good fully charged battery is fully inserted. Check both battery latches are fully engaged and are not broken or getting caught before fully catching. Check battery connection to logic board.
3. Make a visual inspection of the battery connector in the battery bay. Make sure all blades are visible and not bend. If damaged replace the battery connector.
4. Make sure system is not over heating, the air vents are clear and unit was not used on a soft surface.
5. Check that the fan cables are connected and the fans are operational.
6. Make sure all feet are still on the system bottom.
7. Check that the thermal material between the heat exchanger and logic board is in contact with both by unscrewing the logic board screws and gently pulling up on the left side of the board to verify resistance caused by adhesion from the thermal material. If not, new thermal materials for the processor, control ASIC, and video chip must be reinstalled (see Logic Board Take Apart chapter).
8. Remove the battery and connect known-good 65W power adapter (661-1798) and power cord or plug to a known-good power outlet; make sure the DC plug is firmly inserted. The DC plug should light up, if not, replace DC-in board.
9. Verify DC-in board cable is securely connected and cable shows no signs of wear.
10. Try known-good DC-in board.
11. Replace the logic board.

System shuts down almost immediately after startup

1. Disconnect all external peripherals and eject any PC card.
2. Make sure a known good battery is fully inserted and is charged.
3. Check battery connection to logic board.
4. Replace the logic board.

Application Quits, Kernel panic or other booting problems

1. If a specific application quits, replace the application. Verify the application is compatible with OS X.
2. Clear parameter RAM. Hold down Command-Option-P-R during startup until you hear a second startup chime.
3. Run Disk Utility from the Software Install and Restore DVD.
4. Perform a clean install of system software with the software install and restore disc that came with the computer.

Note: Restore disc images are available at <http://service.info.apple.com>. Select “Disc Images.”

5. Reboot system.
6. Run Apple Service Diagnostic in loop mode (Control-L) for an extended time to test the memory. If the test finds bad memory, replace the DIMMs one at a time and test until all bad DIMMs are replaced with known-good modules.
7. Replace the logic board.

Error Beeps

The computer automatically performs a power-on self test when it is turned on after being fully shut down (not a restart). This section describes what to do if beeps are heard during the startup.

Note: The PowerBook G4 (17-inch) uses PC2700 (also called DDR333) DDR SDRAM SO-DIMMs with a maximum height of 1.25-inch (30 mm). Refer to Memory Card Take Apart chapter for removal and installation.

Computer beeps once at startup

1. One beep means that no RAM is detected.

Note: There is no RAM on the logic board itself, so the computer will beep if no memory is installed in at least one of the RAM slots.
2. Put the original RAM that came with the computer back in, or put in known-good and compatible RAM and restart.
 - If symptom does not repeat, replace RAM card(s).
 - If symptom repeats, replace logic board.

Computer beeps twice at startup

1. Two beeps means that EDO memory is installed in the RAM expansion slot. The PowerBook does not accept EDO memory.
2. Replace RAM card(s) with known-good and compatible RAM and restart.
 - If symptom repeats, replace logic board.

Computer beeps three times at startup

1. Three beeps means that no RAM banks passed memory testing.
2. If a RAM card is installed in the upper expansion slot (if not, skip to next step), remove it and restart.
 - If symptom does not repeat, replace RAM card.
 - If symptom repeats, replace RAM in lower RAM slot with known-good and compatible RAM card and restart. If symptom repeats, replace logic board.
3. If a RAM card is not installed in the upper expansion slot, replace RAM in lower RAM slot with known-good and compatible RAM card and restart.
 - If symptom repeats, replace logic board.

Computer beeps four times at startup

1. Four beeps indicates a bad checksum for the remainder of the boot ROM. The ROM (which is located on the logic board) is bad.
2. Replace RAM card(s) with known-good and compatible RAM and restart.
 - If symptom repeats, replace logic board.

Related Knowledge Base articles:

58442: Power On Self-Test Beep Definition - Part 2

95132: PowerBook G4: Installing or Replacing Memory

AirPort Extreme Card

AirPort Extreme Card not recognized

1. In Mac OS X, use Software Update in system preferences or see the Apple Software Updates web page to make sure the latest version of AirPort Extreme software is installed.
2. Restart the computer.
3. Open AirPort in system preferences and make sure AirPort is on and Base Station is selected.
4. Check the AirPort Extreme Card flex cable connection to the logic board.
5. Remove and reinstall the AirPort Extreme software.
6. Replace with known-good AirPort Extreme Card.
7. Replace logic board.

AirPort connection is slow

1. Move computer closer to AirPort Base Station or other AirPort device.
2. Too many users are accessing network at the same time causing heavy network traffic. To improve network connection speed, add additional AirPort Base Stations.
3. Check for other changes in the environment that may cause interference with the AirPort signal.
4. Use Software Update in system preferences or see the Apple Software Updates web page to make sure the latest version of AirPort Extreme software is installed.
5. Restart the computer.
6. Check the AirPort Extreme Card flex cable connection to the logic board.
7. Check the connection on both ends of the AirPort Extreme Card antenna jumper cable, if loose, reconnect and test again.
8. Check the AirPort Extreme Card antenna jumper cable for damaged insulation or a crimped cable. If bad, replace antenna jumper cable.
9. Replace with known-good AirPort Extreme Card.
10. Check AirPort Extreme antenna wire coming from display panel for nicked insulator or crimped wire. If bad, replace display panel assembly.
11. Replace logic board.

Battery

Battery will not eject

1. Flip over the unit and slide both battery latches towards the back of the system, exposing two orange labels. The latches should stay in an open state.
2. If the battery does not pop up, use a small plastic flat-blade tool to pry up the battery around the battery latch.
3. Verify proper latch operation, by exercising the latch. If it does not move smoothly or evenly, replace the bottom case.
4. If the latch does exercise correctly, verify that the customer is not installing the battery with excessive force or the body of the battery has not been deformed around its perimeter.

Note: The aluminum plate on the battery is a cosmetic cover. The battery is contained within the plastic housing to which the plate is attached. If the battery is dropped the plate can deform, especially around the edge near the metal plate. If the metal plate is bent, use non-marring pliers to bend it back flat.

Warning: If the battery plastic housing has been damaged, or the two halves of the plastic housing have separated, the battery is unsafe for use.

5. Try a new battery.
6. Replace bottom case.

The battery won't charge

1. Remove any externally connected peripherals.
2. Try known-good power outlet.
3. Connect known-good 65W power adapter (661-1798) and power cord or plug; make sure the DC plug is firmly inserted. The DC plug should light up, if not, replace DC-in board.

If the power adapter light is green, turn over the computer and press the battery button. The battery lights should glow green and stay on if the power adapter is operating correctly.

Important: The Apple 65W Power Adapter is highly recommended be used with the PowerBook G4 (17-inch) computer. The adapters can be identified by 65W in the name and markings, and the metal securing-stud on the plug connector. Although previous 45W power adapters (see Knowledge Base article 88231 PowerBook and iBook: Apple Power Adapter) are plug compatible with the PowerBook G4 (17-inch), it may not provide sufficient power to operate the system during some activities and may draw power from the battery.

-
4. Try known-good battery. If it charges, replace the battery. If doesn't charge, check the battery connector and its connection to the logic board.
 5. Replace the battery connector assembly (requires removing the logic board).
 6. Turn off the computer. Perform the keyboard PMU reset procedure described in the Hardware Troubleshooting Tools and Tips section. Wait five seconds before continuing. Press the power button to start the computer.

Warning: Resetting the power manager will permanently remove a RAM disk, if present, and all of its contents. You will also need to reset the date and time (using the Date & Time system preference pane).

7. Make sure the DC-in cable is firmly connected. Look for damaged insulation or wires.
8. Replace DC-in cable.
9. Replace DC-in board.
10. Replace logic board.

Bluetooth

Bluetooth system preferences does not show up under Hardware system preferences

1. Check the DC-in flex cable's connection to the Bluetooth card and logic board. Make sure the flex cable is not damaged, is inserted straight and is completely locked down by the locking bar.
2. Replace Bluetooth card.
3. Replace the logic board.

Bluetooth Card not recognized by other devices

1. Open Bluetooth in system preferences and make sure under the Settings tab that Discoverable is checked.
2. Check the Bluetooth antenna is connected to Bluetooth card.
3. Replace with known-good Bluetooth card.
4. Replace display panel assembly.
5. Replace logic board.

Display

Display latch not working

Note: When the display is being closed, hooks in the top of the display housing should be magnetically pulled down to the latch. When the latch button is pushed, the hook should release and retract into the display housing.

1. Verify hook operation by using a small low-power magnet to exercise the latch mechanism. Make sure hooks are not bent.
2. If the hook does not operate properly, replace the display panel assembly.
3. If the latch or latch button does not operate properly, replace the top case assembly.

When displaying a single color over the screen area, the LCD panel shows one or more pixels that are not properly lit

To determine whether or not the display has an acceptable number of pixel anomalies, follow the steps below:

1. Set the display image to one of the following colors: all-white display, all-red display, all-green display, or all-blue display. Knowledge Base article 112125: Service Diagnostics Matrix, has the LCD Tester Diagnostic Utility that will generate these patterns on the screen.
2. Using a jeweler's loupe, pocket microscope, or other magnifying device, identify and count each pixel anomaly:
 - Bright subpixel anomaly = subpixel that is always on
 - Dark subpixel anomaly = subpixel that is always off
3. The number of acceptable pixel anomalies for this system is:

Acceptable Number of Subpixel Anomalies

Bright	Up to 4
Dark	Up to 6
Combination	Up to 8

4. If the number of subpixel anomalies exceeds the acceptable number listed in the above chart, replace the display panel assembly.

Replace

Bright	5 or more
Dark	7 or more
Combination	9 or more

-
5. If the number of subpixel anomalies is acceptable, explain to the customer that the pixel anomalies are within specifications, and no repair is necessary.

Important: Do not release the specifications to customers. Instead, inform them that a certain number of subpixel anomalies are considered acceptable, and these factors apply to all manufacturers using LCD technology—not just Apple products.

When speaking with customers, please use the following explanation:

Active-matrix LCD technology uses rows and columns of addressable locations (pixels) that render text and images on screen. Each pixel location has three separate subpixels (red, green, and blue) that allow the image to be rendered in full color. Each subpixel has a corresponding transistor responsible for turning the subpixel on or off.

There are typically millions of these subpixels on an LCD display. For example, the LCD panel used in the Apple Cinema HD display is made up of 2.3 million pixels and 6.9 million red, green, and blue subpixels. Occasionally, a transistor does not work perfectly, which may result in the affected subpixel being turned on (bright) or turned off (dark). With the millions of subpixels on a display, it is quite possible to have a low number of faulty transistors on an LCD. Therefore, a certain number of subpixel anomalies are considered acceptable. Rejecting all but perfect LCD panels would significantly increase the retail price for products using LCD displays. These factors apply to all manufacturers using LCD technology—not just Apple products.

Hard Drive

Internal hard drive will not initialize:

1. Start up from the software install and restore disc that came with the computer (hold down the "C" key during restart).
2. When the Installer opens, from the Installer menu, select Open Disk Utility.
3. If the hard drive is recognized, format it under the Erase tab.
4. If the hard drive is not recognized, reseal the hard drive flex cable, or replace if needed.
5. If still not recognized, replace the hard drive.
6. Reinstall system software using the software install and restore disc.

Important: If the computer is under warranty and data recovery is required, refer to Knowledge Base article 31077: DriveSavers: Hard Drive Data Recovery & Warranty Implications, for important information.

Keyboard

No response from any key on keyboard

1. Remove any connected peripherals and eject any PC card.
2. Attach an external USB keyboard, if it doesn't work, go to step 7.
3. Turn off the computer. Check the top case flex cable connection to the logic board (under the lower RAM, if installed).
4. Inspect the top case and keyboard flex cable connectors and cables. If the top case flex cable looks bad, replace top case.
5. Start up from the software install and restore disc that came with the computer (hold down the "C" key during restart, if possible) to verify that it is not a software problem.
6. Replace keyboard.
7. Replace logic board.

No keyboard illumination

1. Go to Keyboard system preference pane and make sure the "Illuminate keyboard in low light conditions" check box is checked. Try using system in a dimly lit environment.

Note: The keyboard illumination is not bright enough to be seen in most well lit spaces. In order to view the key being illuminated, the ambient light needs to be dim.

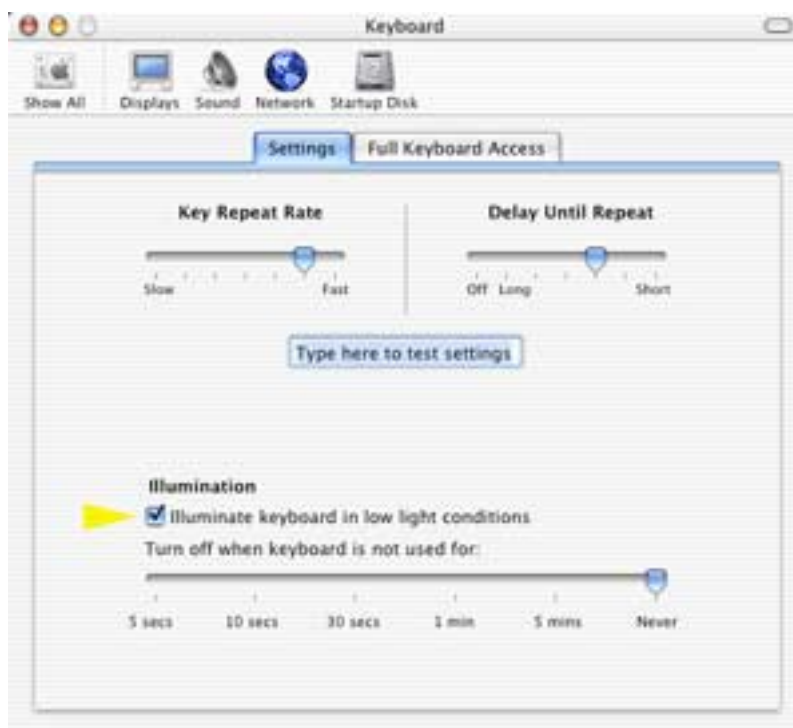

-
2. Check the keyboard backlight cable connection to the top case flex cable and the top case flex cable connection to the logic board. If the connections look good, change the top case.
 3. Replace logic board.

Half keyboard is illuminated.

1. Check the keyboard backlight cable connection to the top case flex cable and the top case flex cable connection to the logic board. If the connections look good, change the top case.

Microphone

The microphone is not working

1. Check the Sound system preference pane and verify the selection under the Input tab is for the built-in microphone.
2. Check the signal level and level meter and adjust the gain.
3. Reset PRAM (Press the power button, then hold down the Option-Command-P-R keys until you hear the startup chime at least one additional time after the initial startup chime).

Warning: Resetting the PRAM will permanently remove a RAM disk, if present and all of its contents. You will also need to reset the date and time (using the Date & Time system preference pane).

4. If there is no sound output from the internal speaker as well as the microphone not working, verify cable connections.
5. Replace sound board flex cable.
6. Replace the sound board.
7. Replace the speaker assembly.
8. Replace the logic board.

Modem

No modem dial tone

1. Check that the correct modem is selected in the Network Port Configuration section of the Network system preferences.
2. Verify known-good analog (not digital) telephone line.
3. Verify known-good RJ-11 telephone cable.
4. Verify RJ-11 cable is not plugged into Ethernet port.
5. Inspect RJ-11 connector and modem port for pin damage.
6. Verify RJ-11 telephone cable is firmly installed in the modem port.
7. If using Apple Remote Access, select Ignore Dial Tone in the Modem control panel. If the modem connects with this settings selected, try another phone line. If using a terminal or communications program, enter atx1 to disable tone detection. To reset the modem back to the factory settings, enter atz.
8. Check RJ-11 wires to DC-in board. Replace if bad.
9. Verify RJ-11 wire's 2-pin connectors are plugged into correctly.
10. Check modem flex cable is properly installed. Replace cable if needed.
11. Replace modem.
12. Replace logic board.

Modem does not respond (can hear dial tone)

1. Check that the correct modem is selected in the Network Port Configuration section of the Network system preferences.
2. Check modem application is properly configured.
3. Check modem flex cable is properly installed. Replace cable if needed.
4. Replace modem.
5. Replace logic board.

Optical Drive

The optical drive does not accept CD or DVD disc (mechanical failure)

1. Verify disc is not warped and is a 12 cm circular disc.
2. Check that a small disc is not stuck inside, or other foreign objects. Remove drive from system to extract disc.
3. Verify disc is pushed almost all the way into the slot.
4. Check the optical drive flex cable.
5. Replace optical drive.

The disc icon does not show up on desktop, or a dialog box appears to initialize disc, when inserting a read-only disc

1. Verify the correct type of disc is being used.
2. Use Software Update system preference pane to check if there is updated firmware.
3. Try cleaning the disc. If it is dirty or scratched, it may not mount.
4. Try a different disc.
5. Replace optical drive cable.
6. Replace optical drive.

Difficulty writing to optical media

1. Verify the correct type of disc is being used.
2. Try a different brand or speed of CD-R disc.

Note: Some brands of 24x or 32x CD-R media may not work with the SuperDrive.

Note: There are two factors in the ability for the optical drive to write to media. First, there are varying qualities of blank optical media. Some media are made to such low specifications that the ability for the drive to write to it is marginal.

There are variations in optical media even under the same brand. Some brands source their optical media from a variety of manufacturers, so there may be variations in the quality.

Second, an optical drive that supports writing to a CD-R/RW or DVD-R/RW disc requires a special writing algorithm for discs from different disc manufacturers. There are hundreds of disc manufacturers, it is impossible to implement writing algorithms for each disc manufacturer. Usually, drive manufacturers implement special writing algorithms for discs from major disc manufacturers. For discs that are not supported by the drive with special writing algorithms, the drive will use a generic writing algorithm to write the disc. In this case, the writability and readability may not be optimal.

3. Replace optical drive flex cable.
4. Replace optical drive.

PC Card

PC Card will not insert into the PC Card slot

1. Make sure the PC Card eject button is in, before attempting to insert a PC Card.
2. Make sure the PC Card is right side up (cards are keyed and cannot be inserted upside down).
3. Verify the PC Card is not warped or damaged in any way; if so replace the card.
4. Try a different PC Card.
5. Carefully raise the PC Card slot cover and check for a foreign object inside the slot.
6. Check to see if the AirPort Extreme Card antenna wire is protruding up into the PC Card slot opening from below. If so, open the computer to gain access to the AirPort Extreme Card location and reposition the antenna cable so that it does not protrude into the PC Card slot area (see AirPort Extreme Card Take Apart chapter).
7. If the slot cover is preventing the card from being inserted, replace the top case.
8. Replace PC Card Cage.

PC Card does not mount to the desktop

1. Make sure the PC Card has its drivers installed.
2. Check if a known good PC card works in this slot. The PC card may be bad.
3. Check the PC card cage flex cable connection to the logic board.
4. Replace the PC card cage.
5. Replace the logic board.

Ports

A USB port is not recognizing devices

1. Completely shut down, then press the power button to start the computer.
2. Use Software Update system preferences to verify that the latest software is installed.
3. For USB, test ports with an Apple keyboard or mouse. If the left port is not recognized check the DC-in flex cable's condition and connection. If the right port is not recognized check the backup battery flex cable's condition and connection.
4. If the USB flex cables are fine, replace the DC-in board for the left USB port or the backup battery board for the right port.
5. Use Apple System Profiler to verify that the computer is recognizing the bus. If not replace the logic board.

A USB device not recognized by computer

Note: If you are trying to use a serial device with a USB/Serial adapter, check with the manufacturer of the adapter for compatibility.

1. Completely shut down, then press the power button to start the computer.
2. Verify current driver for the device is installed.
3. If a camera, turn on camera after initiating download with camera application.
4. Try the other USB port.
5. Try different USB device on same port.
6. Eliminate chain by plugging in only one peripheral.
7. Try known-good Apple USB keyboard or mouse to verify the port is working properly. If the left port is bad, check the DC-in board flex cable and connections. If the right port is bad, check the backup battery flex cable and connections.
8. If the USB flex cables are fine, replace the DC-in board for the left USB port or the backup battery board for the right port.
9. Replace logic board.

A FireWire port is not recognizing devices

1. Test the FireWire 400 and FireWire 800 ports by connecting to another computer using FireWire Target Disk Mode.

Refer to Knowledge Base article 58583: How to Use FireWire Target Disk Mode.

Important: When in FireWire Target Disk Mode, use only one FireWire port at a time. Otherwise you risk corrupting the internal hard drive volume.

2. Verify that drivers are installed properly for third party, if needed.

-
3. Make sure the cables are firmly attached.
 4. Try a different cable.
 5. If self powered make sure that the power supply is connected and device's LED indicates that it is getting power.
 6. Replace logic board.

Sound

No sound heard and the Speakers section of the Sound system preference pane indicates that an external device is plugged in (to the headphone jack or USB ports)

1. If there is nothing plugged into the headphone jack or USB ports, under the Output tab of the Sound system preference pane should be set to the internal speakers.
2. If not, and if nothing is plugged in, try plugging in headphones or external speakers. Restart the computer. Remove the device.
3. Reset PRAM (Press the power button, then hold down the Option-Command-P-R keys until you hear the startup chime at least one additional time after the initial startup chime).

Warning: Resetting the PRAM will permanently remove a RAM disk, if present, and all of its contents. You will also need to reset the date and time (using the Date & Time system preferences pane).

4. Check the sound board flex cable to see if the cable is properly seated, the connection is good, and there is no cable damage.
5. Replace sound board.
6. Replace logic board.

No sound from speaker(s)

1. Use the Software Update system preference pane to verify that the latest audio update has been installed.
2. Press the F3 key (with the fn key pressed and not pressed) to verify that mute mode is not enabled.
3. Press the F4 or F5 key (with the fn key pressed and not pressed) to check the volume setting.
4. Verify no external speakers or headphones are plugged in.
5. Check the speakers tab on the Sound control panel to confirm that the software is correctly seeing that there are no external speakers or headphones connected.
6. Shutdown computer and restart.

-
7. Reset PRAM (Press the power button, then hold down the Option-Command-P-R keys until you hear the startup chime at least one additional time after the initial startup chime).

Warning: Resetting the PRAM will permanently remove a RAM disk, if present, and all of its contents. You will also need to reset the date and time (using the Date & Time system preference pane).

8. Verify that the speaker cable is connected properly to sound board.
9. Check speaker cable. Verify left and right cable connections.
10. Check with headphones or external speaker, if audio is heard, replace speaker assembly.
11. Replace sound board flex cable.
12. Replace sound board.
13. Replace the logic board.

Distorted sound from speakers

1. Verify sound is correct with external speakers/headphones. If sound is correct, check speaker wire and connections.
2. In Sound system preference pane, check balance.
3. Compare same sound with two different units to make sure that sound is actually distorted.
4. Check speaker wire. If damaged, replace speaker assembly.
5. Replace sound board.
6. Replace sound board flex cable.
7. Replace logic board.

Trackpad

The cursor does not move when you are using trackpad

1. Verify that no USB device is connected.
2. Boot from the Software Install and Restore DVD to verify that it is not a software problem.
3. Reset the power manager by pressing the key combination Control-Option-Shift Power.

Note: Make sure you do not hold down the "fn" key when resetting the power manager.

4. Check top case flex cable connection to the logic board (under the lower RAM, if installed).
5. Check trackpad cable and connection to the top case.
6. Replace top case.
7. Replace logic board.

The cursor intermittently does not move or moves erratically

Note: User must touch with the surface of only one finger at a time and point directly down on the trackpad surface.

1. Clean trackpad surface (with computer off, using a non-static-inducing material).
2. Completely shut down, then press the power button to start the computer.
3. Reset the power manager by pressing the key combination Control-Option-Shift-power.

Note: Make sure you do not hold down the "fn" key when resetting the power manager.

4. Try unit on battery power. If problem goes away, replace power adapter.
5. Place the Software Install and Restore DVD in the optical disc drive, press the start button and hold down the "C" key. Check the cursor movement, to see if the problem is software.
6. Check top case flex cable connection to the logic board (under the lower RAM, if installed).
7. Check trackpad cable and connection to the top case.
8. Replace top case.
9. Replace logic board.

Video

No display, or dim display, but computer appears to operate correctly

1. Remove any connected peripherals.
2. Make sure F1 key is not stuck down.
3. Press the F2 key (with the fn key pressed and not pressed) to increase the screen brightness settings.
4. Reboot the computer—hold down the Control and Command keys and press the Power button to restart the computer. Or, press and hold the Power button for 5 to 10 seconds to shut down the computer, then press the Power button to restart.
5. **Important:** The Apple 65W Power Adapter is highly recommended be used with the PowerBook G4 (17-inch) computer. The adapters can be identified by 65W in the name and markings, and the metal securing-stud on the plug connector. Although previous 45W power adapters (see Knowledge Base article 88231 PowerBook and iBook: Apple Power Adapter) are plug compatible with the PowerBook G4 (17-inch), it may not have sufficient power to operate the system during some activities and may draw power from the battery.
6. Verify inverter cable and LVDS cable connections are seated properly and that the cables are not damaged.
7. Replace display panel assembly.
8. Replace logic board.

Computer appears to work, but no video on external device connected to the TV out port (S-video out port)

1. The device must be connected to the S-video port while the PowerBook is sleeping or off for the device to be recognized.
2. Verify monitor that is used in testing is known-good and is supported by this computer.
3. Try different cable(s).
4. Replace logic board.

No video on an external VGA device connected to the external monitor (DVI) port

1. Verify monitor that is used in testing is known-good and is supported by this computer.
2. Try another DVI-to-VGA adapter cable.
3. Restart the computer and test again.
4. Replace logic board.

Misc. Symptoms

The Date and Time settings reset all the time

Note: Resetting the power manager or PRAM resets the date and time.

1. Do a backup battery test:
 - Set the date and time.
 - Perform a Shut Down from the Apple menu.
 - Remove the main battery and disconnect the power adapter for 10 minutes.
 - Connect the power adapter, insert the battery, and power on the computer.
 - If the date and time were lost the backup battery may be dead or discharged.
 - Remove the main battery from the unit and leave the PowerBook plugged in for at least 5 hours.

Note: If a discharged main battery is installed in the computer, recharging the backup battery may take up to 48 hours to completely charge. It is okay to use it while it is charging.

- If the date and time still reset, replace the backup battery flex cable.

2. Replace backup battery board.
3. Replace the logic board.

Note: For main and backup battery part numbers, refer to Knowledge Base article 11751: Macintosh Family: Batteries and Part Numbers.

Feet came off the bottom case

1. Replace the bottom case.

Sleep LED does not come on when lid is closed

1. Put the computer to sleep using the menu option. If the sleep LED goes on, there is a problem with lid sensing. If not skip to step 3.
2. Put a small low-power magnet over the trackpad and move it around. If the unit sleeps, replace the top case. If not replace the display panel assembly.
3. Check that the sleep LED is plugged into the sound board.
4. Connect a USB mouse. Short the power on pads on the logic board to boot the system and use the mouse to sleep from the menu. Measure the voltage at the LED connector. If power is present, replace bottom case.
5. Shut down system.
6. Check the sound board flex cable is properly connected to the sound and logic boards. Make sure the connectors on the flex cable are not damaged. Check the sleep LED.
7. Replace the sound board flex cable.

-
8. Shut down system.
 9. Replace sound board.
 10. Replace logic board.



Views

PowerBook G4 (17-inch)

