



## PowerBook 3400c/PowerBook G3

---

PowerBook 3400c/180, 3400c/200, and PowerBook  
G3



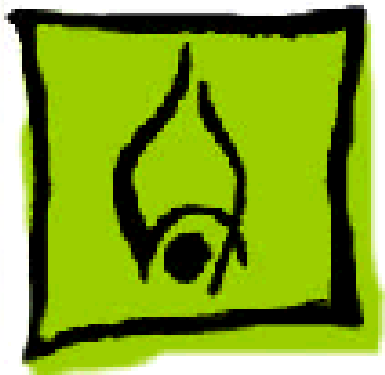

## Hot Issues

---

PowerBook 3400/G3





## Overview

This chapter is designed to highlight unique or high-priority product issues that you should be aware of before servicing the PowerBook 3400 and PowerBook G3.

This chapter alerts you to important issues and provides links to other areas in the manual where more complete information can be found. This chapter is not intended to replace other parts of this manual; it merely provides a pointer to pertinent information in those chapters.

The date the Hot Issue was published is indicated in parentheses after the title.





## PowerBook 3400: Modem Driver Update

**Issue:** Customers may report one of the following problems with their PowerBook 3400 modem:

- 1 The modem will not reset following a disconnect. I sometimes have to wait 10 to 30 minutes before I can reconnect to my service provider. Does this happen because the modem is too hot?
- 2 When uploading a file using z-modem protocol I often get multiple errors and my computer freezes or I get a system error.
- 3 When I am downloading large files (2-2.5 MB) over the modem I often get intermittent disconnects.





**Solution:** These problems are not heat-related. To address these situations, Apple has released a modem driver update.

Since many users believed these issues were heat-related, they have had many dealers replace these modems. This driver should resolve the issues and prevent needless hardware replacement.

The Modem Driver update is posted at the Apple Software Updates site. Apple Software Updates can be found on the Service Source Companion 1 CD, and online as follows: America Online, CompuServe, <ftp.info.apple.com>, and <ftp.support.apple.com>, [www.info.apple.com](http://www.info.apple.com), and [www.support.apple.com](http://www.support.apple.com). The path for the update is:

Apple Software Updates

US

Macintosh

Unsupported





PB 3400 Modem Driver Update.img

PB 3400 Modem Driver Update Info

The software is in the form of a disk image and requires Disk Copy 6.1 (or later) or Disk Image Mounter (or later). These can be downloaded from the Utilities folder under Macintosh in the path listed above. The Info article provides installation instructions.

Unsupported software is provided for customers to download and use, but it is at your own risk. Apple does not provide technical support for unsupported software.

This revision will be supported when it is rolled into the next official software update.





## PowerBook 3400: Display Cable Gasket Installation (8/97 and 10/97)

**Issue:** The display cables on some PowerBook 3400 computers have been working loose from their logic board connections. The customer-reported symptoms related to this issue include no display image or backlight while the computer is running.

**Solution:** The solution in the 8/97 Hot Issue was to install a foam gasket to the underside of the brightness and speaker grill to keep the cable connector in place. In fact, the foam gasket is not available as a service part and cannot be ordered separately.

If customers report symptoms related to a loose PowerBook 3400 display cable—intermittent or no display image/backlight—service providers should replace the brightness





and speaker grill, part number 922-2488. All service grills come with the foam gasket installed.

## PowerBook 3400: Battery Gasket Installation (8/97)

**Issue:** A small number of PowerBook 3400 computers running on battery power have unexpectedly shut down when jostled or when pressure was applied to the battery area. The problem is due to intermittent battery contact.

**Solution:** If a PowerBook 3400 exhibits the above problem, Apple recommends adding a foam gasket to the inside of the battery bay to improve battery contact. The gasket is available free of charge in a user-installable kit. To order the kit, customers may call 1-888-273-3594. Alternatively, service providers may install the gasket for







customers and can order the kit as service part number 076-0706. The installation is a warranty repair.

For instructions on installing the Battery Gasket, see “Battery Gasket Installation” in the Additional Procedures chapter of this manual.





## Basics

---

PowerBook 3400c/PowerBook G3





# Product Overview

## PowerBook 3400c

The PowerBook 3400c computer is an all-in-one notebook with several features that greatly increase its performance. Its 603e microprocessor runs at a clock frequency of 180, 200 or 240 MHz. In addition to the 256K L2 cache, the PowerBook 3400c comes with 16 MB of RAM and is upgradeable to 144 MB.

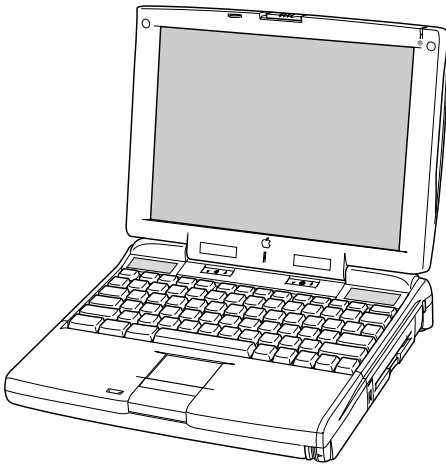



The system includes a 1, 2, or 3 GB hard drive, optional CD-ROM drive, and standard 1.44 MB floppy drive. And, with its 12.1" display, the screen is larger than previous PowerBook displays.

## **PowerBook G3**

The PowerBook G3 is based on the PowerBook 3400c, but due to its 250-MHz PowerPC G3 processor, L2 backside cache, and improved bus speed, the PowerBook G3 is approximately twice as fast as the 240-MHz PowerBook 3400c. The PowerBook G3 also includes more RAM on board, a higher powered battery, and a larger hard drive than the PowerBook 3400c. In addition, the PowerBook G3 is shipping with MacOS 8, which is optimized to run with the G3 processor. The combination of these features results in PowerBook G3 break-through performance.





# System Configurations

The PowerBook 3400c and G3 come in these configurations:

## **PowerBook 3400c/180 (February '97)**

- Processor: 180-MHz PowerPC 603e
- RAM: 16 MB
- Drives: 1 GB hard drive; 1.44 floppy drive; optional 6x CD-ROM drive
- Display: 12.1-inch SVGA

## **PowerBook 3400c/200 (February '97)**

- Processor: 200-MHz PowerPC 603e
- RAM: 16 MB
- Drives: 2 GB hard drive; 1.44 floppy drive; 6x CD-ROM drive
- Display: 12.1-inch SVGA
- Modem: EtherNet/modem card



**PowerBook 3400c/240 (March '97)**

- Processor: 240-MHz PowerPC 603e
- RAM: 16 MB
- Drives: 3 GB hard drive; 1.44 floppy drive; 12x CD-ROM drive
- Display: 12.1-inch SVGA
- Modem: EtherNet/modem card

**PowerBook G3 (November '97)**

- Processor: 250-MHz PowerPC G3
- Cache: L2 backside cache
- RAM: 32 MB
- Drives: 5 GB hard drive; 1.44 floppy drive; 20x CD-ROM drive
- Display: 12.1-inch SVGA
- Modem: EtherNet/modem card





## View of Front and Right Side

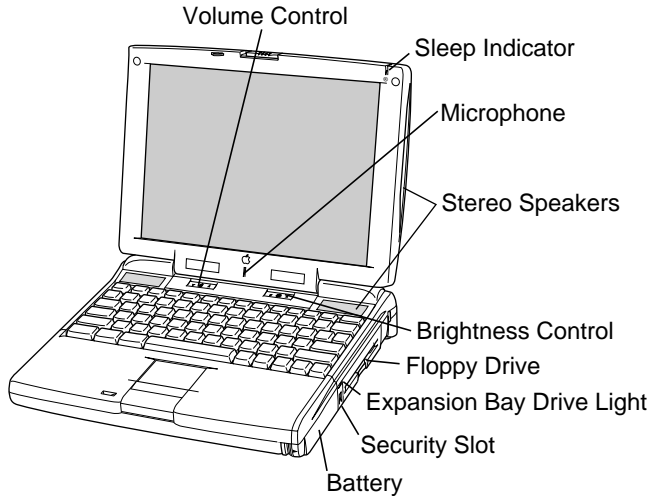

The front of the computer includes the following: stereo speakers, volume control, brightness control, sleep indicator, and microphone.

The right side includes the battery, security slot, expansion bay drive light, and floppy drive.





## View of Rear and Left Side

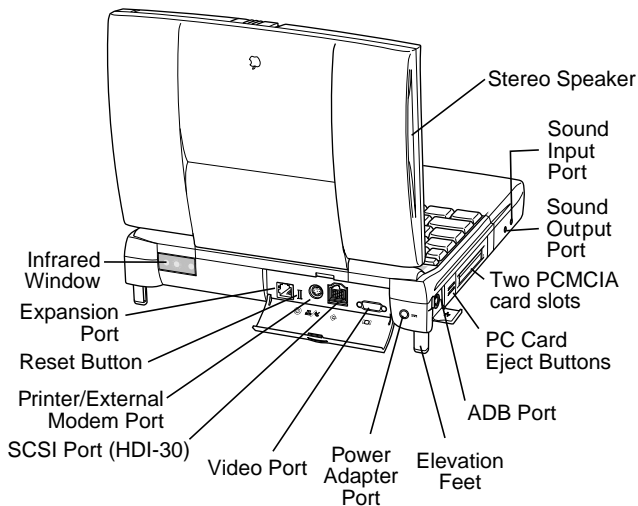

The rear panel includes the infrared window, reset button, and these ports: expansion, printer/external modem, SCSI, video, and power adapter.

The left side includes a stereo speaker, two PC card (PCMCIA) slots, PC card eject buttons, and these ports: sound input, sound output, and ADB.







## Logic Board

The logic board includes onboard RAM, the PCMCIA mechanism, and numerous connectors.

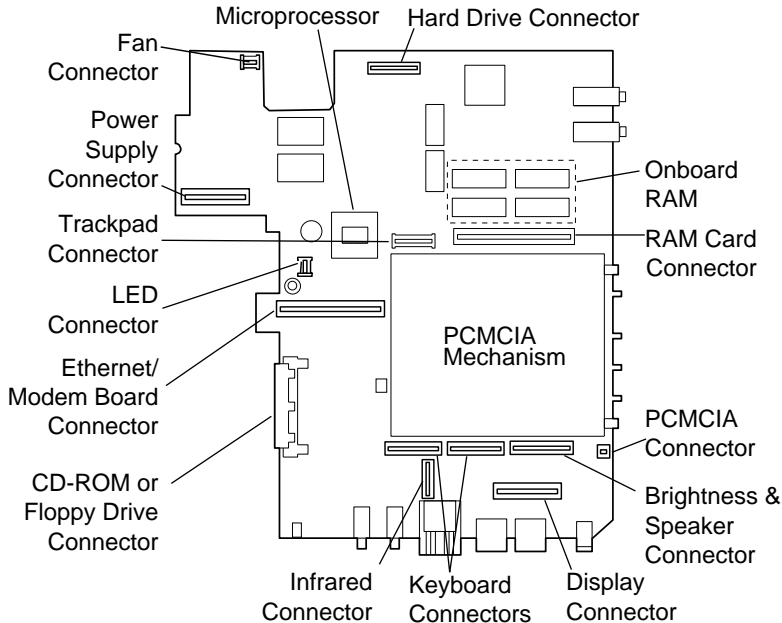



## Signals on the Video Connector

<b>Pin</b>	<b>Signal Name</b>	<b>Description</b>
1	RED	Red video signal
2	GREEN	Green video signal
3	BLUE	Blue video signal
4	MONID(0)	Monitor ID signal 0
5	GND	DDC return
6, 7, 8	AGND_VID	Analog video ground
9	+5V_IO 5 V	Power for I/O device
10	GND HSYNC & VSYNC	Ground
11	VGA_ID	VGA ID signal
12	MONID(2)	Monitor ID signal 2
13	HSYNC	Horizontal synchronization signal
14	VSYNC	Vertical synchronization signal
15	MONID(1)	Monitor ID signal 1





## Battery Information

**Warning:** For the main battery, use only the lithium-ion (Lilon) battery supplied with the computer. Batteries designed for other portable computers may look similar, but they may not work with your computer and may damage it.

The Lilon and nickel-metal-hydride (NiMH) batteries look similar. To distinguish them,

- Read the label on the battery, which will identify the battery as either “Lilon” or “NiMH.”
- Look for battery indicator lights; if the battery has them, it’s a Lilon battery.





## Main Battery

For their main batteries, the PowerBook 3400c and G3 use lithium ion (Lilon) batteries. Each battery provides power for up to four hours of work time.

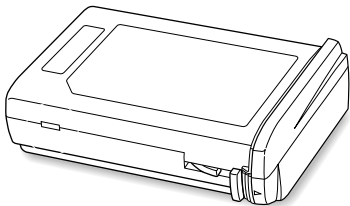

**Note:** Although these batteries fit into a PowerBook 190/5300, it will not recognize or charge them.

**Note:** To use the PowerBook G3 battery in a PowerBook 3400c, you may need to install a software update.





## Optional Battery

The PowerBook 3400c and G3 computers can also use a nickel-metal-hydride (NiMH) battery. This battery provides somewhat less work time; the precise amount of work time depends on the model you have and the battery conservation features you use.

## Battery Handling Guidelines

The following are guidelines for properly handling the PowerBook 3400c and G3 batteries:

**Warning:** Lilon batteries contain hazardous chemicals and should not be thrown out with household or office trash. Take dead batteries to an Apple authorized service provider for recycling or proper disposal. Review battery handling and disposal instructions in Safety Information in Bulletins/





### Safety.

- Handle the battery carefully. Do not drop, puncture, disassemble, mutilate, or incinerate it.
- Do not leave a battery in the computer for longer than a week without plugging in the power adapter.
- Always put the battery cap on the battery when the battery is out of the PowerBook. The battery contacts should not be exposed when the battery is out of the computer.
- Do not leave the battery in hot locations (such as the trunk of a car).
- Do not leave a battery in storage for longer than six months without recharging it.
- Never get batteries wet.
- Do not short-circuit the battery terminals. Doing so may cause an explosion or a fire.
- Recharge batteries only as described in the user's manual and only in ventilated areas.





## PC Card Handling

Two PC Card slots (also known as PCMCIA slots) are featured in the PowerBook 3400c and G3 computers.

The two slots accept a variety of third-party PC Cards with 68-pin connectors.

There are three types of PC Cards: Type I (3.3 mm), Type II (5 mm), and Type III (10.5 mm). Type I and Type II cards fit in either the upper or lower slot of the PC

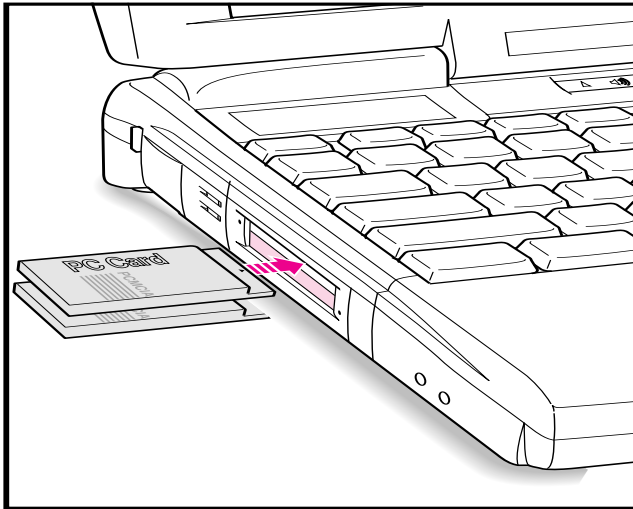



Card unit. Type III cards can only be placed in the lower slot. When a Type III card is in the lower slot, the upper slot cannot be used.

The following are guidelines for properly handling PC Cards:

- Use only cards that are compatible with the PC Card unit. Refer to the compatibility information that came with the card. If you cannot find the compatibility information, call the card vendor.
- Do not insert anything other than a PC Card into the card slots.
- The computer must be on or off in order to eject a PC Card. When the computer is in sleep mode, a PC Card cannot be ejected.
- Before you eject a card, make sure nothing is blocking the card's slot.







- If you want to use the card again immediately, pull it out about an inch more and then push it back in. If you don't follow this procedure and try to push the card back in to use it again, the card will not engage properly.
- Do not pull on a PC Card before it has been ejected out of the slot. Forcing a PC Card out of the slot may damage the computer or the card.





## Specifications

PowerBook 3400c /PowerBook G3





## Processor

### CPU

<b>PowerBook 3400c</b>	PowerPC 603e microprocessor running at 180, 200, or 240 MHz
<b>PowerBook G3</b>	PowerPC G3 microprocessor running at 250 MHz

### Cache

<b>PowerBook 3400c</b>	256K, second-level (L2) cache
<b>PowerBook G3</b>	512K, L2 backside cache





# Memory

## RAM

**PowerBook 3400c**

16 MB EDO RAM, expandable to 144 MB

**PowerBook G3**

32 MB EDO RAM, expandable to 160 MB

## ROM

4 MB ROM

## VRAM

2 MB VRAM





## Disk Storage

### Floppy Drive

Removable 1.44 MB floppy drive (in the expansion bay). Reads and writes Macintosh 1.4 MB and 800K floppy disks, as well as Windows, DOS, and OS/2 720K and 1.44 MB floppy disks.

### Hard Drives

1.3, 2.0, 3, or 5 GB 2.5" hard drive

### CD-ROM Drives

#### PowerBook 3400c

Optional, removable 6x-speed CD-ROM drive in the expansion bay, if included (PowerBook 3400c/180; PowerBook 3400c/200)

Removable 12x-speed CD-ROM drive in the expansion bay (PowerBook 3400c/240)

#### PowerBook G3

Removable 20x-speed CD-ROM drive in the expansion bay





## I/O Interfaces

### **SCSI**

SCSI port (HDI-30 connector) for hard drives, scanners, printers, and other devices; also supports PowerBook SCSI disk mode

### **PC Cards**

Two PC Card (PCMCIA card) slots support either two Type I or Type II cards or one Type III card  
Lower slot also supports “zoom video,” a method of displaying video signals from a PC card

### **ADB**

Apple Desktop Bus (ADB) port for keyboard, mouse, or other input devices using a low-speed, synchronous serial bus  
200 mA maximum current draw for all ADB devices  
Supports up to three ADB devices in a daisy chain





- Serial** Serial port for printer, modem (including Geo Port support), LocalTalk network, or other serial devices (RS-422)
- Sound** Sound output port for external audio amplifier/powered speakers, stereo mini-jack, 3-connector, standard 3.5-mm stereo miniplug; sound input port for stereo sound input (line level), stereo mini-jack, 3-connector, standard 3.5-mm stereo miniplug  
16-bit stereo sound in and out supports 44.1 kHz (“CD quality” sound), 22 kHz, and 11 kHz sample rates  
Four built-in speakers; two housed in the display and two at the top of the keyboard
- Infrared** Built-in infrared that supports two types of transmission—230 kilobit-per-second IRTalk and 1 megabit-per-second IrDA





**Power Adapter**

Power adapter port

**Video**

Video port for up to 16-bit/thousands-of-color video output to most Apple monitors (with the supplied adapter), VGA monitors (640 x 480), and SVGA monitors (800 x 600, 1024 x 768)

**Security**

Connector on side panel allows users to attach security device; also secures battery and any module in expansion bay







## Expansion Interfaces

### **Expansion Bay**

Expansion bay accepts a removable expansion bay module (floppy drive, CD-ROM drive) or other modules





## I/O Devices

### **Keyboard**

Built-in keyboard with 12 function keys  
76 keys domestic, 77 keys ISO  
3.0-mm travel keyboard  
19-mm vertical and horizontal pitch

### **Trackpad**

Integrated, solid-state trackpad

### **Microphone**

Internal, electret, omnidirectional microphone





## Video

### **Display**

12.1" diagonal, 800 x 600 active matrix color SVGA; thousands of colors





## Electrical

### **Main Battery**

Rechargeable lithium ion (Lilon) battery  
2-4 hours of use before recharging

### **Power Adapter**

100-240 VAC line voltage, 50-60 Hz

### **Backup Battery**

60 milliampere (mAh) rechargeable NiMH battery for calendar/clock maintenance. Also backs up contents of RAM for a few minutes while battery is changed (when PowerBook is in sleep mode)





## Physical

### **Dimensions**

Height: 2.4 in. (65.6 mm)

Width: 11.5 in. (293 mm)

Depth: 9.5 in (239.5 mm)

### **Weight**

7.2 lb. (3.2 kg) with floppy drive installed

7.4 lb. (3.3 kg) with CD-ROM drive installed





## Environmental

**Operating  
Temperature**

50° to 95° F (10° to 35° C)

**Storage  
Temperature**

-13° to 140° F (-25° to 60° C)

**Relative Humidity**

20% to 80% noncondensing

**Operating Altitude**

10,000 ft. (3,048 m) maximum

**Shipping/Non-  
Operating Altitude**

15,000 ft. (4,572 m) maximum





## Troubleshooting

---

PowerBook 3400c/PowerBook G3





## General

In each product manual on Service Source, you will find Flowcharts and/or Symptom Charts designed to help you diagnose and repair Apple computers.

If you have narrowed the problem down to a particular symptom, start with the Symptom Charts. Because cures are listed in the order of most likely solution, try the first cure first. Verify whether or not the product continues to exhibit the symptom. If the symptom persists, try the next cure.

If you are not sure what the problem is, or if the Symptom Charts do not resolve the problem, refer to the Flowcharts.

If you require additional assistance, contact Apple Technical Support. Refer to the About topic under the Do menu for the Apple Technical Support phone number.







# Symptom Charts

## Startup

RAM failure occurs  
(eight-tone error  
chord sequence  
sounds after startup  
chord)

- 1 Remove RAM card (if present) and restart computer. If startup sequence is normal, replace RAM card and retest.
- 2 Reseat RAM card and check connection.
- 3 Replace RAM card.
- 4 Replace logic board.





Hardware failure occurs (four-tone error chord sequence sounds after startup chord)

- 1 Reset PRAM.
- 2 Remove floppy drive from media bay and restart computer. If startup sequence is normal, insert floppy drive and retest.
- 3 Replace floppy mechanism.
- 4 Disconnect hard drive cable and restart computer. If startup sequence is normal, reconnect cable and retest.
- 5 Replace hard drive.
- 6 Replace logic board.

Startup failure occurs when using minimum System Folder and System 7.6.

Upgrade to System Enabler 1.2.1 or later. Refer to Apple Software Updates on Service Source Companion CD.





## Power

**Note:** You will hear only the click of the power-on button when you attempt to start up a computer that lacks sufficient power to start.

Computer won't  
power up

- 1 If sleep LED is continually on, backup battery power has been interrupted. Restart computer by holding down reset actuator 10-20 seconds. If computer doesn't restart, repeat 3-4 times.
- 2 Try known-good power adapter.
- 3 Try known-good, charged battery.
- 4 Connect power adapter and restart computer in 3-4 minutes.
- 5 Replace power supply board.
- 6 Replace logic board.





Screen is blank;  
computer doesn't  
respond

- 1 If sleep LED is continually on, backup battery power has been interrupted. Restart computer by holding down reset actuator 10-20 seconds. If computer doesn't restart, repeat 3-4 times.
- 2 Restart computer.
- 3 Disconnect power adapter, remove battery, and restart computer in 3-4 minutes.
- 4 Check power adapter cable.
- 5 Try known-good, charged battery.
- 6 Try known-good power adapter.
- 7 Reset power manager.
- 8 Check all logic board cables and connections.
- 9 Replace keyboard.
- 10 Replace power supply board.
- 11 Replace logic board.





After you remove battery, some Control Panel settings are different

- 1 Check keyboard and backup battery cables and connections.
- 2 Replace backup battery.
- 3 Replace logic board.

Computer runs when plugged into wall outlet but not on battery power; battery voltage is within tolerance

- 1 Reset power manager.
- 2 Reseat battery to make sure battery is mating with contacts on logic board.
- 3 Try known-good battery.
- 4 Try known-good power adapter.
- 5 Replace power supply board.
- 6 Replace logic board.





Power adapter is plugged in, but Control Strip doesn't indicate adapter is connected

- 1 Verify that power adapter is connected correctly.
- 2 Try known-good power adapter.
- 3 Replace logic board.

When Shutdown is selected with power adapter plugged in, computer shuts down but immediately powers back up

- 1 Reset PRAM.
- 2 Disconnect power adapter, remove battery, disconnect backup battery, and wait 15 minutes before retesting.





Low-power warning appears

- 1 Attach power adapter and recharge battery.
- 2 Disconnect peripherals. If warning disappears when peripherals are disconnected, verify that peripherals are low-power.
- 3 Reduce use of CD-ROM, floppy, or hard drive; sound; backlight; or other power-consuming devices. Or, reconnect power adapter.
- 4 Try known-good, charged battery.
- 5 Try known-good power adapter.
- 6 Inspect power adapter port: Verify that connector is not loose; if it is, replace main logic board.
- 7 Replace power supply board.
- 8 Replace logic board.





## Video

**Note:** A certain number of defects are inherent in display technology and vary by many factors, including type of technology. If you suspect that your display contains an abnormal number of defects, call Apple Technical Support.

Partial or full row of pixels is always on or never comes on in an active matrix display

- 1 Check display and backlight cables and connections.
- 2 If display cable connection to logic board is loose, replace brightness and speaker grill.
- 3 Replace display.
- 4 Replace logic board.







Display is very light  
or totally white

- 1 Adjust screen contrast and brightness settings.
- 2 Verify display cable, inverter board, and logic board connections.
- 3 If display cable connection to logic board is loose, replace brightness and speaker grill.
- 4 Replace inverter board.
- 5 Replace display.
- 6 Replace logic board.

Display stopped  
working or dimmed  
but is fine now

- 1 Replace display.





Backlight doesn't  
operate

- 1 Adjust screen brightness setting.
- 2 Verify that backlight cable connection is secure.
- 3 Check display cable, inverter board, and logic board connections.
- 4 If display cable connection to logic board is loose, replace brightness and speaker grill.
- 5 Verify that cables are not pinched or severed.
- 6 Replace inverter board.
- 7 Replace display.
- 8 Replace logic board.





No display, but computer appears to operate correctly

**Note:** If sleep light is blinking and computer is not in sleep mode, reset power manager.

- 1 Insert disk into floppy drive and press Command-e (eject disk) to verify that computer is working.
- 2 Adjust screen brightness setting.
- 3 Verify display cable, inverter board, trackpad, keyboard, and logic board connections.
- 4 If display cable connection to logic board is loose, replace brightness and speaker grill.
- 5 Connect power adapter.
- 6 Replace inverter board.
- 7 Replace display.
- 8 Replace logic board.





Thin white line is always on at middle of screen

- 1 Change the desktop pattern; if the line remains, replace display.

An external monitor connected to the PowerBook shows no video

- 1 Verify cable and cable connections between monitor and video board.

An external monitor connected to the PowerBook shows either horizontal or vertical rolling, or horizontal or vertical distortion

- 1 Verify monitor using another computer.
- 2 Replace logic board.





## Sound

No sound from speaker(s)

- 1 Verify that volume setting in Control Panel is above 0.
- 2 Verify that no external speaker is plugged in.
- 3 Check display cable connections.
- 4 Check inverter board connections.
- 5 Replace display cable.
- 6 Replace inverter board.
- 7 Replace speaker(s).
- 8 Replace logic board.





## Floppy Drive

**Note:** The floppy drive cable referred to in this section is the cable **inside** of the floppy drive case.

Audio and video present, but floppy drive in media bay does not operate

- 1 Try known-good floppy disk.
- 2 Check floppy drive cable connection.
- 3 Replace floppy drive cable.
- 4 Replace floppy drive.
- 5 Replace logic board.





Disk ejects while booting; display shows Mac icon with blinking X

- 1 Try known-good system disk.
- 2 Verify that floppy disk is not locked.
- 3 Verify that trackpad and trackpad button are working.
- 4 Verify that keyboard is working.
- 5 Check floppy drive cable connection.
- 6 Replace floppy drive cable.
- 7 Replace floppy drive.
- 8 Replace logic board.





- |                           |  |
|---------------------------|--|
| Disk does not eject       | <ol style="list-style-type: none"><li data-bbox="445 104 1499 184">1 Switch off system and hold trackpad button down while you switch system on.</li><li data-bbox="445 197 1499 277">2 Eject disk manually by carefully inserting opened paper clip into hole near floppy drive slot.</li><li data-bbox="445 291 1499 324">3 Check floppy drive cable connection.</li><li data-bbox="445 337 1499 370">4 Replace floppy drive cable.</li><li data-bbox="445 384 1499 417">5 Replace floppy drive.</li><li data-bbox="445 430 1499 464">6 Replace logic board.</li></ol> |
| Disk initialization fails | <ol style="list-style-type: none"><li data-bbox="445 529 1099 562">1 Try known-good floppy disk.</li><li data-bbox="445 576 1099 609">2 Check floppy drive cable connection.</li><li data-bbox="445 622 1099 655">3 Replace floppy drive cable.</li><li data-bbox="445 669 1099 702">4 Replace floppy drive.</li><li data-bbox="445 715 1099 749">5 Replace logic board.</li></ol>   |







Read/write/copy  
error

- 1 Try known-good floppy disk.
- 2 Check floppy drive cable connection.
- 3 Try to format a floppy disk.
- 4 Replace floppy drive cable.
- 5 Replace floppy drive.
- 6 Replace logic board.





## Hard Drive

Internal hard drive  
does not spin up

- 1 Make sure power adapter is connected.
- 2 Disconnect external SCSI devices.
- 3 Check hard drive cable connection.
- 4 Replace hard drive cable.
- 5 Use Hard Drive Format to reinitialize drive.
- 6 Replace hard drive.
- 7 Replace logic board.





## CD-ROM Drive

CD-ROM drive does not accept disc

- 1 Replace disc (if dirty or damaged).
- 2 Reinsert CD-ROM drive.
- 3 Replace CD-ROM drive.

Volume control does not operate correctly

- 1 Check Control Panel Sound setting.
- 2 Reinsert CD-ROM drive.

Macintosh cannot mount CD-ROM drive

- 1 Reinsert CD-ROM drive.
- 2 Replace CD-ROM drive.





Audio and video present, but CD-ROM drive in media bay does not operate

- 1 Try known-good CD-ROM disc.
- 2 Check CD-ROM drive cable connections (inside CD-ROM case).
- 3 Replace CD-ROM drive cable.
- 4 Replace CD-ROM drive.





## PC Card Module (PCMCIA)

PC Card won't eject

- 1 Make sure computer is not in sleep mode.
- 2 Make sure PC Card slot is not blocked.
- 3 Insert straightened paper clip into hole next to slot.
- 4 Use needlenose pliers to remove PC Card.
- 5 Verify that PC Card is not warped or damaged in any way; if so, replace with new card.

PC Card is inserted but doesn't appear on desktop

**Note:** Modem and communication cards may not appear on desktop.

- 1 Try PC Card in the other slot.
- 2 Replace PC Card.
- 3 Replace PC Card cage.
- 4 Replace logic board.





**Note:** If “defective card” or “unrecognizable card” appears in place of card name in PCMCIA Eject control panel, card is damaged or computer does not have software required to support it. Eject card.

System with PC card performs poorly or hangs during floppy drive operations

Replace logic board.





## Infrared Communication

Infrared communication is not working

- 1 Clean infrared window with soft lint-free cloth.
- 2 Verify infrared cable connection.
- 3 Verify infrared signal is being received by host computer.
- 4 Replace infrared cable.
- 5 Replace infrared board.





## Peripherals

After you connect external SCSI device, computer does not boot

- 1 Verify that device and SCSI chain are terminated correctly.
- 2 Switch on external SCSI device before starting computer.
- 3 Check cable connections.
- 4 Try known-good SCSI cable.
- 5 Verify that SCSI ID select switch setting on external device is unique.
- 6 Try known-good external SCSI device.
- 7 Replace logic board.







Cursor does not move when you are using trackpad

- 1 Shut down computer, unplug adapter, and remove battery. Let computer sit for 1 minute before restarting.
- 2 Reset power manager.
- 3 Check trackpad connections.
- 4 Check keyboard and logic board connections.
- 5 Connect low-power mouse and try to move cursor. If cursor moves, try using trackpad and keyboard. If trackpad does not move cursor, replace trackpad. If keyboard does not respond, replace keyboard.
- 6 Replace logic board.





Cursor intermittently does not move or moves erratically

**Note:** User must touch trackpad with the surface of only one finger at a time and point directly down on the trackpad surface.

- 1 Clean trackpad surface (with computer off, using a non-static inducing material).
- 2 Check trackpad connections.
- 3 Replace trackpad.
- 4 Replace keyboard.
- 5 Replace logic board.





Cursor moves, but  
clicking trackpad  
button has no effect

- 1 Reset power manager.
- 2 Check trackpad connections.
- 3 Check keyboard and logic board connections.
- 4 Replace trackpad cable.
- 5 Replace trackpad.
- 6 Replace keyboard.
- 7 Replace logic board.





Cursor does not move when you are using mouse

- 1 Check mouse connection to ADB port.
- 2 Try a known-good low-power mouse. If the known-good mouse works, clean mouse ball and inside of original mouse and retest. If the original mouse still doesn't work, replace it.
- 3 Replace logic board.

No response to any key on keyboard

- 1 Verify that computer is on.
- 2 Reset the power manager.
- 3 Check keyboard connection by disconnecting and reconnecting keyboard cables.
- 4 Replace keyboard.
- 5 Replace logic board.





Known-good direct-connect printer does not print

- 1 Reset PRAM.
- 2 Verify that Chooser and Control Panel settings are correct.
- 3 Check cables.
- 4 Replace printer cable.
- 5 Try known-good printer.
- 6 Replace logic board.

Known-good network printer does not print

- 1 Reset PRAM.
- 2 Verify that Chooser and Control Panel settings are correct.
- 3 Check cables.
- 4 Attach computer directly to printer, and retest.
- 5 Replace logic board.





I/O devices are unrecognized, or garbage is transmitted or received

- 1 Reset PRAM.
- 2 Check cables.
- 3 Verify that SCSI device is correctly terminated.
- 4 Verify that SCSI select switch setting on external device is unique.
- 5 Test device with known-good computer.
- 6 Replace logic board.

In disk mode, computer does not display SCSI icon until host is booted, or computer crashes when host is shut down

- 1 Verify that computer has a unique SCSI ID.
- 2 Check that SCSI disk mode cable is good and that connection is tight.
- 3 Replace logic board.





## Miscellaneous

Sleep light won't come on

- 1 Verify that computer is in sleep mode and not powered off.
- 2 Reset power manager.
- 3 Replace inverter board.

Screen goes blank and computer shuts down every few minutes

Computer is going into system sleep to conserve battery power. Adjust sleep delays in Control Panel or connect power adapter.

Application seems to run slower after a few seconds

Computer is switching to system rest. If system rest is interfering with operation of application, connect power adapter.

Hard drive is slow to respond, or screen goes blank too often

Adjust sleep delays in Control Panel or connect power adapter.



# Troubleshooting Flowchart—Startup Problems

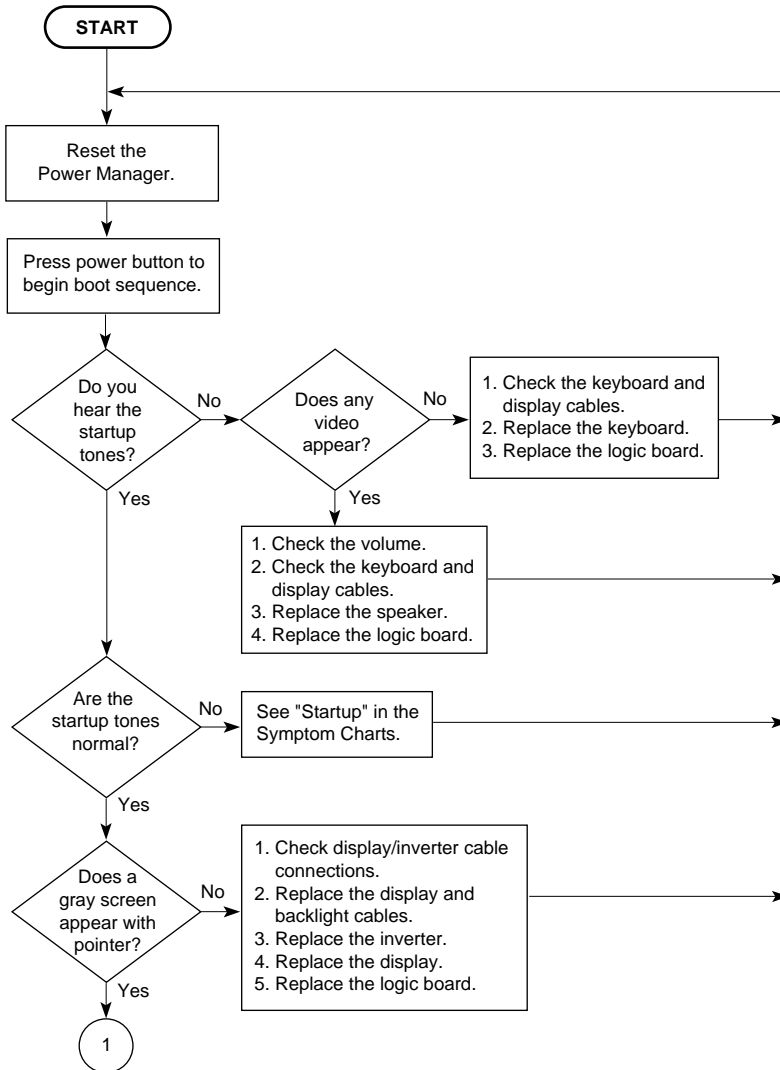



# Troubleshooting Flowchart—Startup Problems

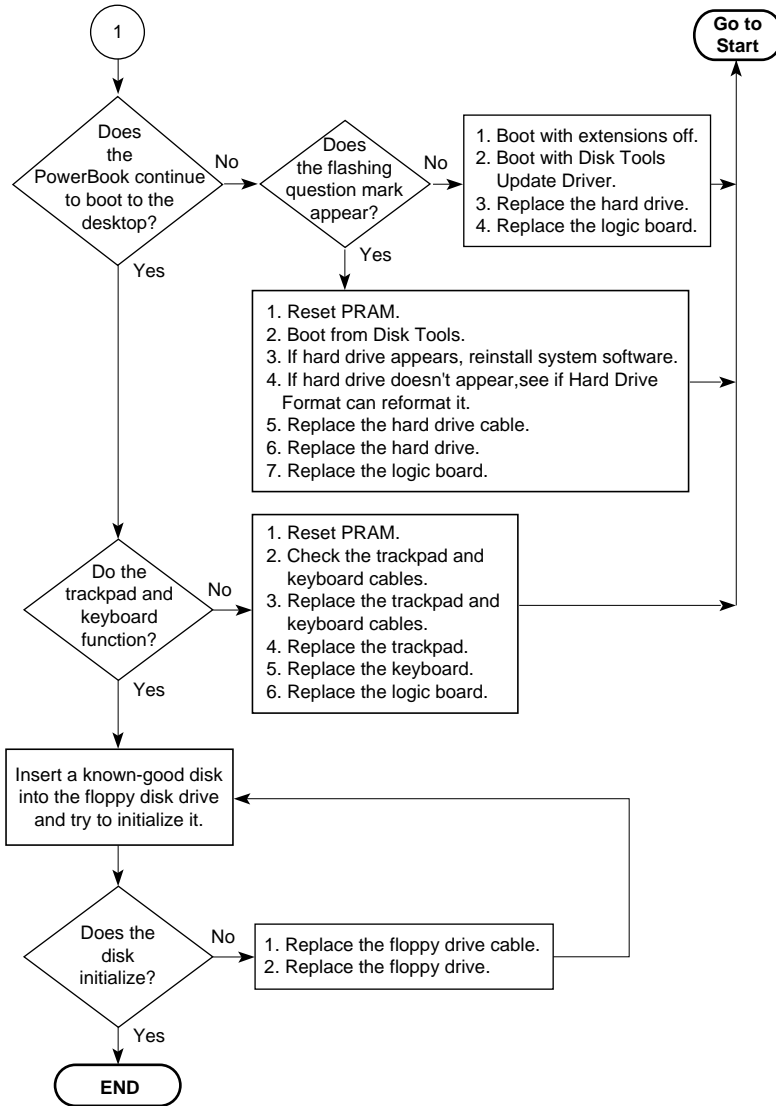



## Take Apart

---

PowerBook 3400c /PowerBook G3





## Tools

Use the following tools for taking apart these computers:

- Small, flat-blade screwdriver
- #8 Torx driver (for removing most screws)
- #6 Torx driver (for removing the floppy drive screws)
- Swizzle stick (for removing name plates and kapton tape)
- Dental pick (for opening flex connectors)





## Screws

There are 38 screws installed in these PowerBooks (not including the CD-ROM drive) in 12 different sizes.

You will notice that each part other than the floppy drive case kit uses only one type of screw, which makes reassembly easier than in other PowerBooks. For example, the display frame uses 6 identical screws and the trackpad button uses 2 identical screws.

For the location of each screw in the computers, refer to the Exploded View chapter.





## Bottom Case Assembly

Procedures for removing parts from the bottom case assembly are detailed on the following pages.





## Battery

Before you begin, unplug the power adapter

**Caution:** You must remove the battery before performing any take-apart procedure.



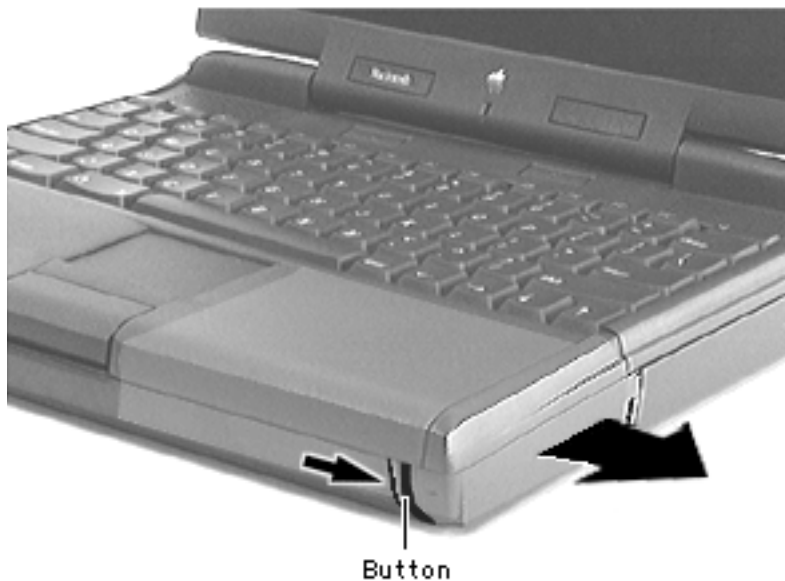

- 1 Push the button and slide the battery out of the media bay.

**Replacement Caution:** You must install the battery before connecting the power adapter.





## Floppy Drive Assembly

No preliminary steps are required

**Note:** Media bay devices require approximately 7 lb. pull strength.



Floppy Drive Assembly





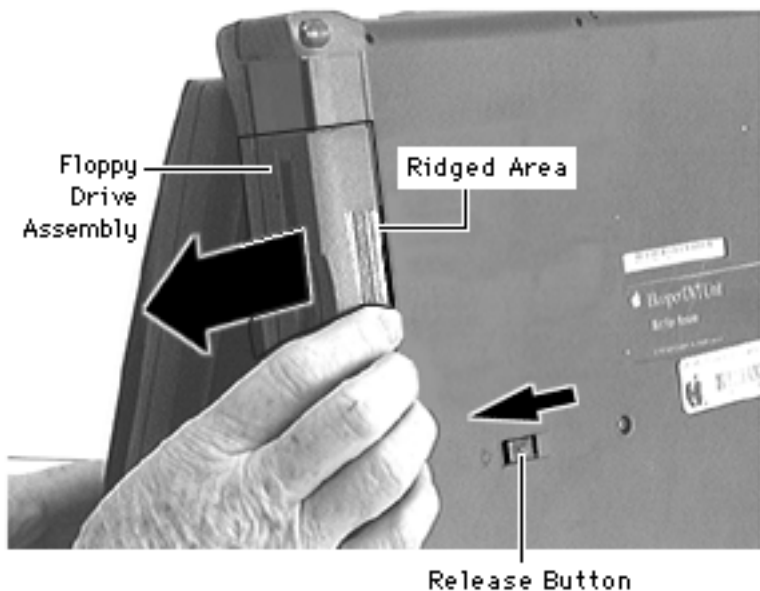

**Caution:** To remove the assembly without damaging it, turn the unit upside down, as shown.

- 1 Slide the release button forward.

**Caution:** Grasp the ridged area of the plastics— **not** the metal cover. This prevents bending the metal top case and possibly damaging the drive.

- 2 Grasp the floppy drive assembly by its ridged area and pull it out of the media bay.





**Replacement Caution:** Media bay tolerances are tight. Align media bay devices carefully before inserting them into the bay.





## CD-ROM Drive Assembly

No preliminary steps are required.

**Note:** Media bay devices require approximately 7 lb. pull strength.

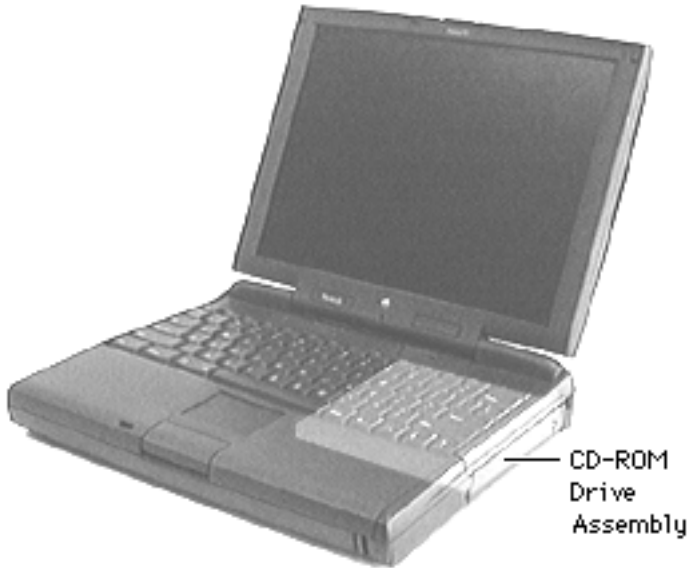

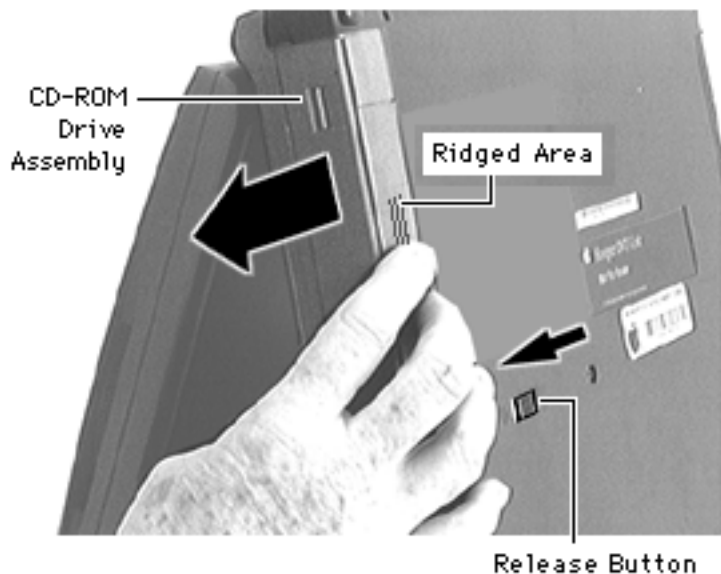

**Caution:** To remove the assembly without damaging it, turn the unit upside down, as shown.

- 1 Slide the release button forward.

**Caution:** Grasp the ridged area of the plastics— **not** the metal cover. This prevents bending the metal top case and possibly damaging the drive.

- 2 Grasp the CD-ROM drive assembly by its ridged area and pull it out of the media bay.





**Replacement Caution:** Media bay tolerances are tight. Align media bay devices carefully before inserting them into the bay.





## Keyboard

Before you begin, remove the following:

- Battery
- Floppy or CD-ROM Drive Assembly



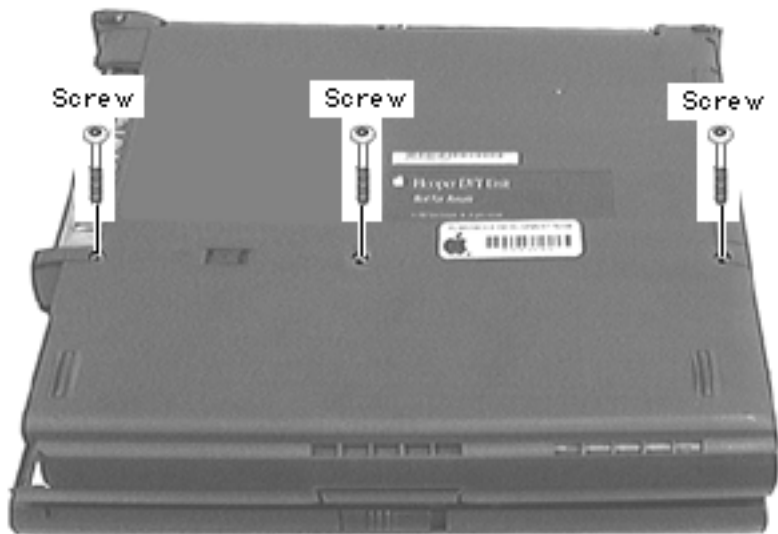

- 1 Close the computer and turn it upside down.
- 2 Remove the 3 interchangeable screws from the bottom case.



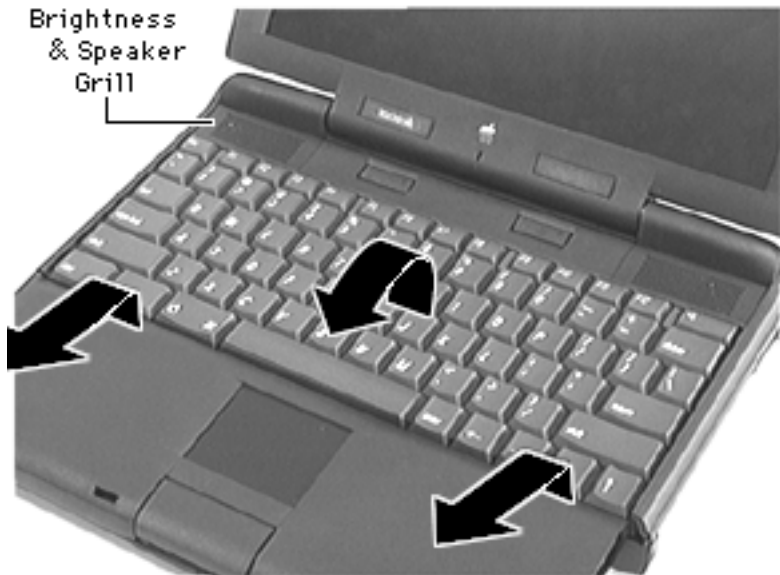

3 Open the computer.

**Caution:** If you pull the keyboard too far, you will rip the keyboard cables out of their connectors. Pull the keyboard just enough so its 4 interior tabs clear the brightness & speaker grill.

4 Inserting a flat-blade screwdriver under the front of the keyboard, lift the keyboard slightly up and toward you until you feel a slight resistance.





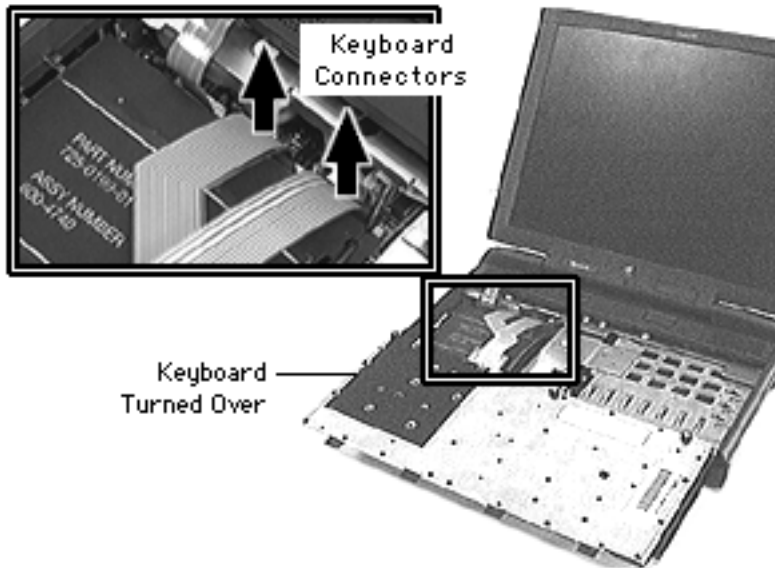

- 5 Gently turn the keyboard onto the palm rest.

**Caution:** To avoid damaging the backup battery wires, gently pull them out of their 2 catches on the PCMCIA insulator. Then move them to the side so they clear the right-hand keyboard connector.

- 6 Using a dental pick, detach the keyboard cables from their connectors.



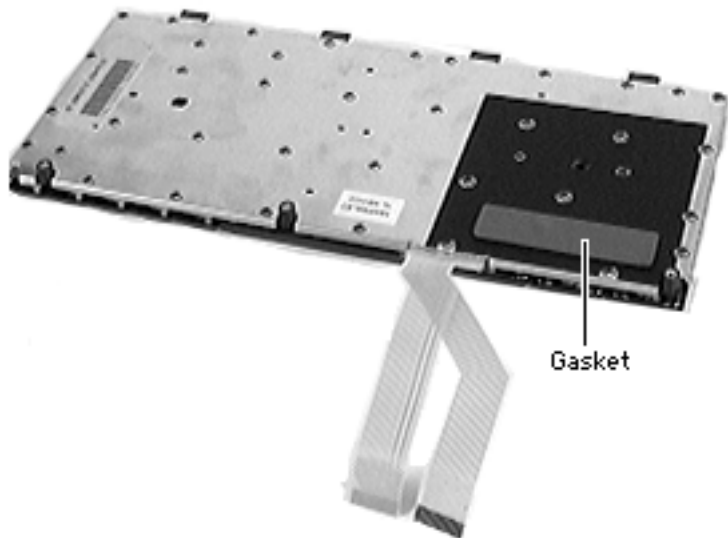

- 7 If a foam gasket is not already installed on the bottom of the keyboard, install a gasket (part number 922-3103) as illustrated.

**Replacement Note:** As you replace each keyboard screw, apply pressure to the area of the keyboard immediately behind each screw hole. This allows the screws to install more easily.





RAM Card

## RAM Card

Before you begin, remove the following:

- Battery
- Floppy Drive
- Keyboard





RAM Card

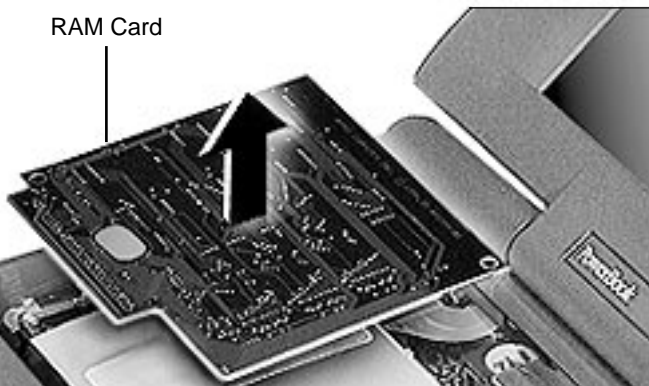

Grasp the RAM card by the corners closest to you—supporting the bottom left corner over the connector—and lift straight up.





## Brightness & Speaker Grill

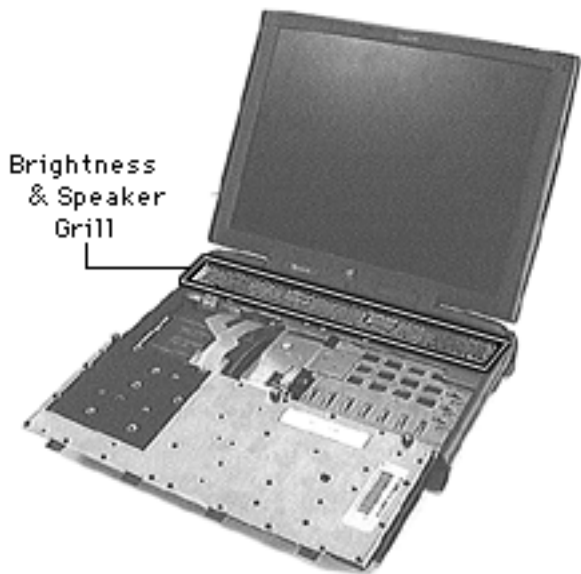

Before you begin, remove the following:

- Battery
- Floppy or CD-ROM Drive Assembly
- Keyboard

**Note:** If you are not performing an additional take-apart, it is not necessary to detach the cables of the keyboard.





Brightness  
& Speaker  
Connector

Screw

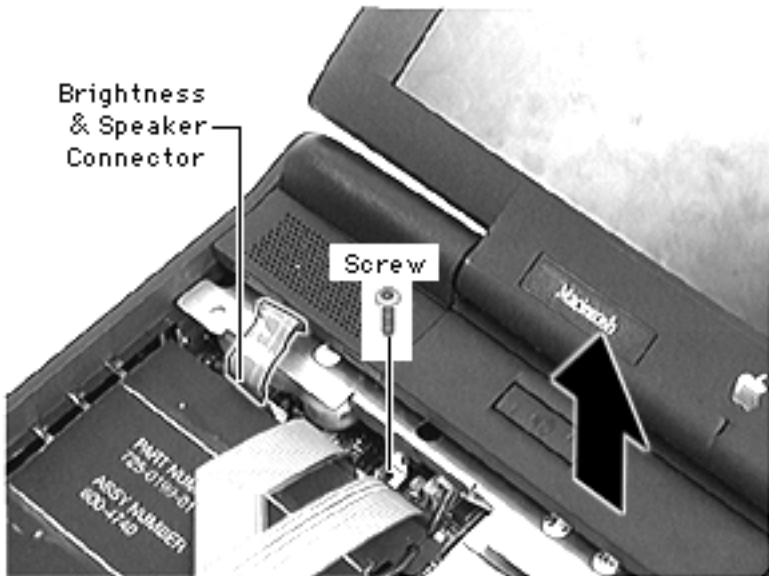

- 1 Using a dental pick, detach the brightness & speaker cable from its connector.
- 2 Remove the screw from the brightness & speaker grill.
- 3 Lift off the brightness & speaker grill.







## Left & Right Clutch Covers

Before you begin, remove the following:

- Battery
- Floppy or CD-ROM Drive Assembly
- Keyboard
- Brightness & Speaker Grill





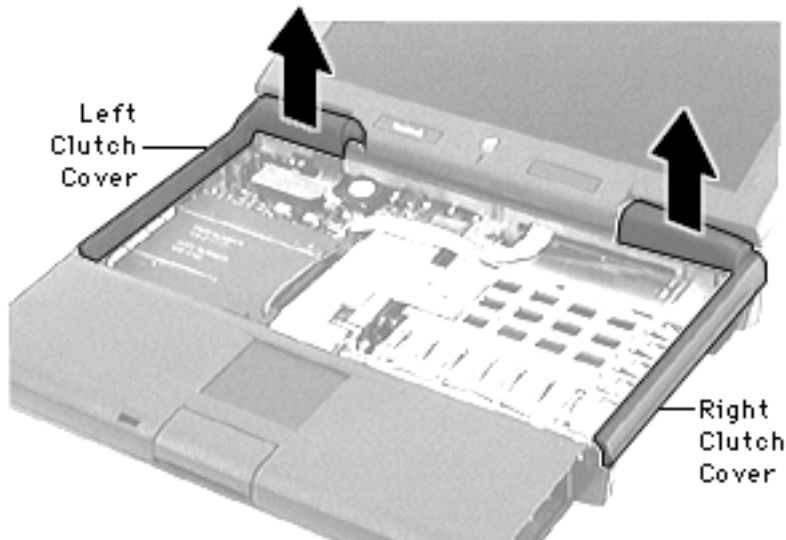

- 1 Position the display assembly at 170° from the body of the computer.
- 2 Grasp the area of the clutch cover under the display. Using a fingernail, pull up from the seam in back and gently rock the cover until it releases.
- 3 Pull the cover straight up, watching to clear the bottom of the display assembly.





**Replacement Note:** Install the palm rest before installing the right & left clutch covers. (The tabs on the palm rest fit under the clutch cover tabs.)





## Palm Rest

Before you begin, remove the following:

- Battery
- Floppy or CD-ROM Drive Assembly
- Keyboard
- Brightness & Speaker Grill
- Left & Right Clutch Covers



**Caution:** Be careful not to pull the trackpad cable out of the connector as you turn over the palm rest.



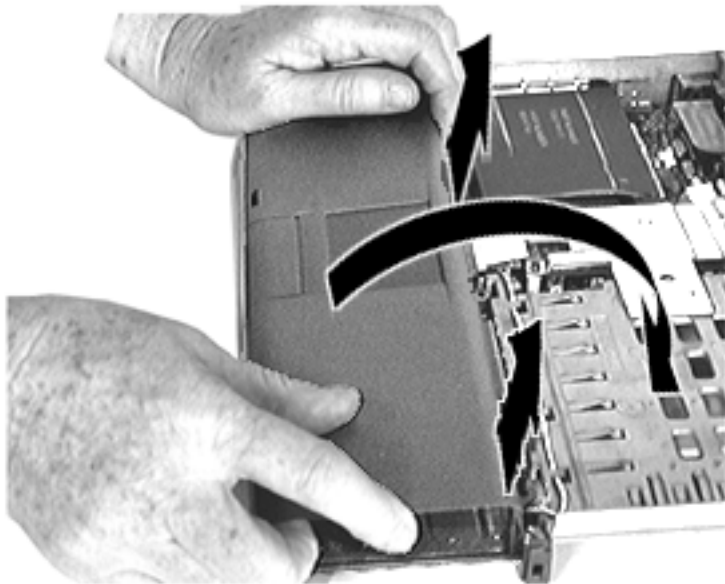

- 1 Grasp the right corner of the palm rest and pull it up.
- 2 Grasp the top ridge of the palm rest and pull it up.
- 3 Turn the palm rest over and set it in the area the keyboard occupied.



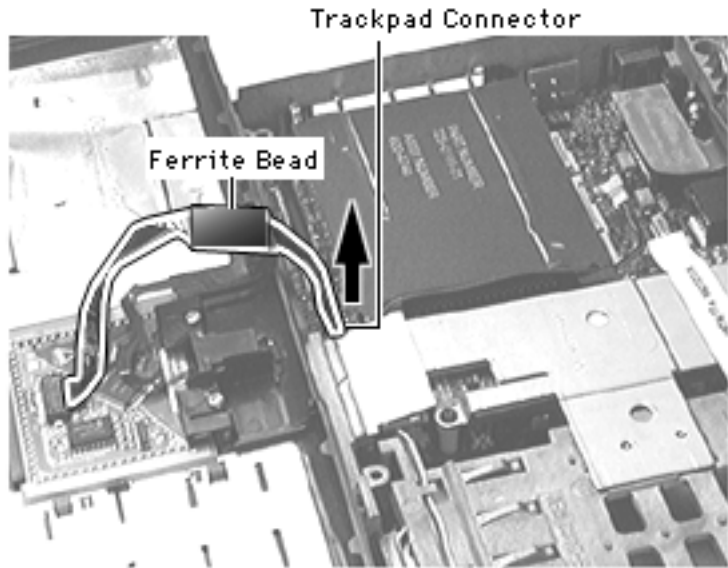

- 4 Using a dental pick, detach the trackpad connector.

**Replacement Notes:**

- Before you connect the trackpad cable to the logic board, make sure the ferrite bead is installed.
- Install the palm rest before installing the left & right clutch covers. (The palm rest tabs fit under the clutch cover tabs.)





## Trackpad

Before you begin, remove the following:

- Battery
- Floppy or CD-ROM Drive Assembly
- Keyboard
- Brightness & Speaker Grill
- Left & Right Clutch Covers
- Palm Rest

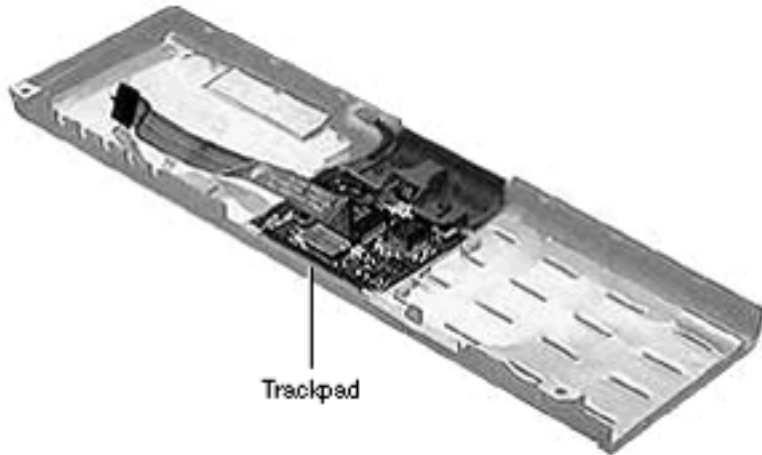



- 1 Remove the 2 interchangeable screws that hold the trackpad button in place.

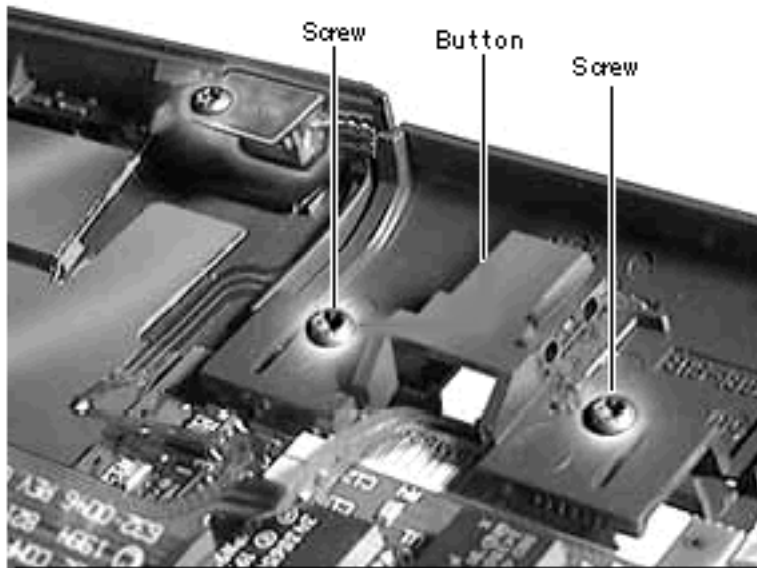

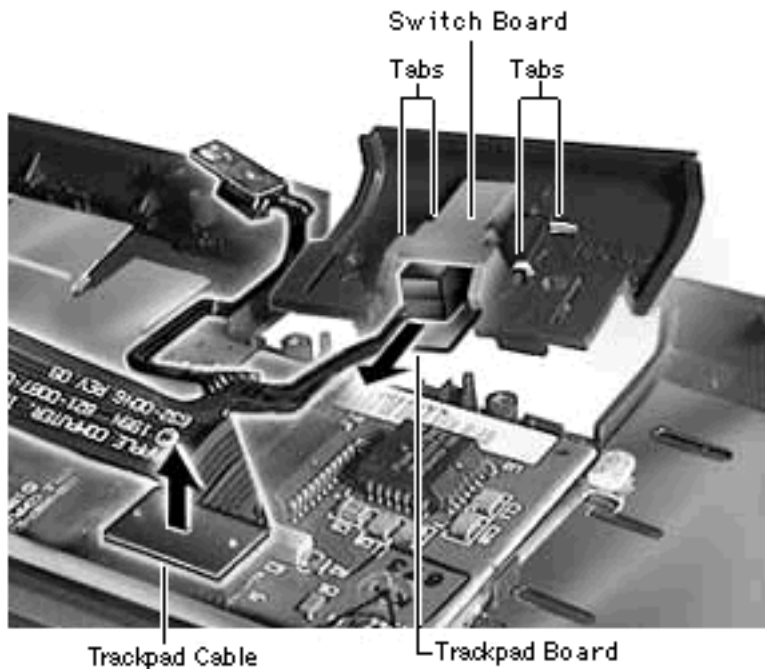

- 2 Slide the switch board out from the 4 tabs holding it in place.
- 3 Disconnect the trackpad cable from the trackpad board.
- 4 Lift the trackpad board out from under the mounting ledge.

**Replacement Note:** Note the 2 tiny notches on the trackpad (near the bottom) and how they align with the tabs in the plastics.







**Note:** Use a nonstatic inducing material to clean the trackpad surface, making sure the computer is **off**.





## Sleep Actuator

Before you begin, remove the following:

- Battery
- Floppy or CD-ROM Drive Assembly
- Keyboard
- Brightness & Speaker Grill
- Left & Right Clutch Covers
- Palm Rest

**Note:** Removing the sleep actuator is not necessary for further take-apart.

1 Remove the screw that

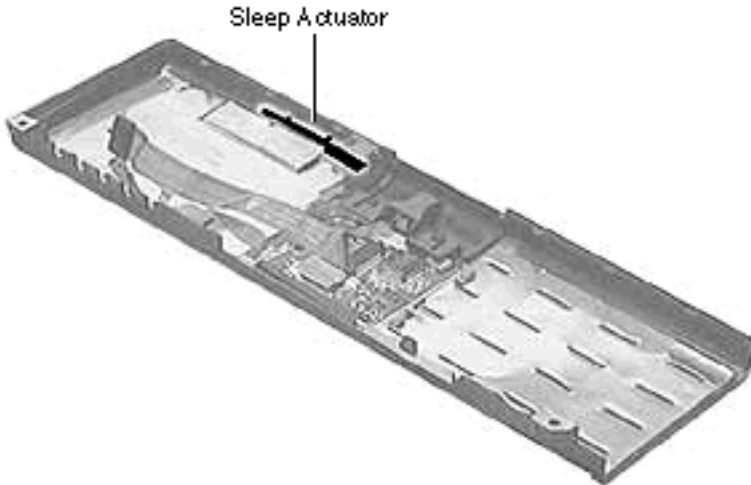

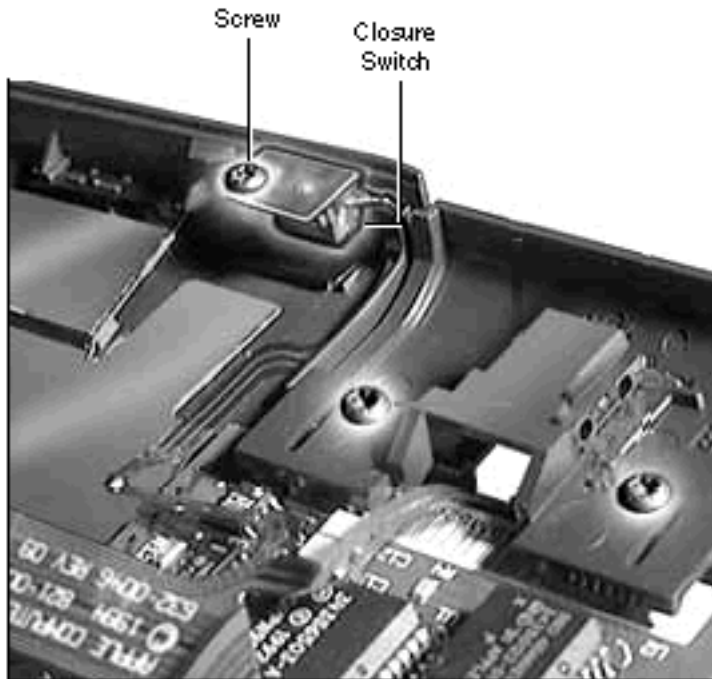

holds the closure switch in place.

- 2 Place a flat-blade screwdriver behind the



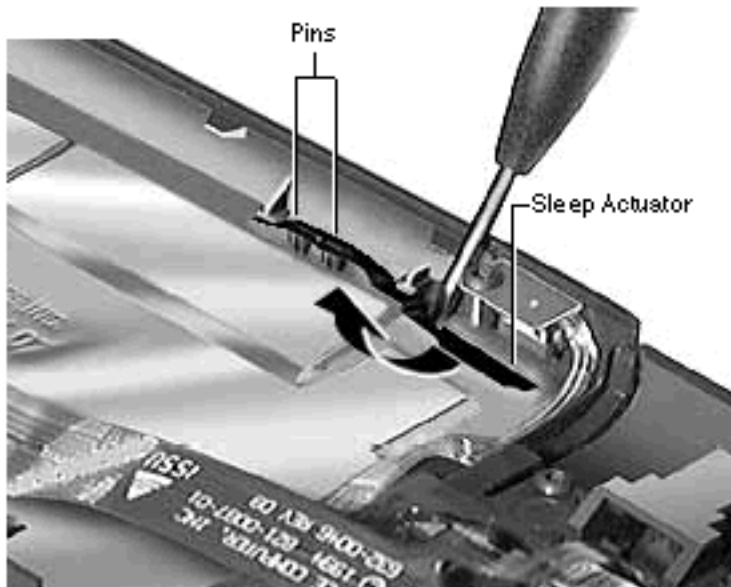

actuator and push the actuator out from the palm rest.

- 3 Lift the actuator off its pins.





## Hard Drive

Before you begin, remove the following:

- Battery
- Floppy or CD-ROM Drive Assembly
- Keyboard
- Brightness & Speaker Grill
- Left & Right Clutch Covers
- Palm Rest

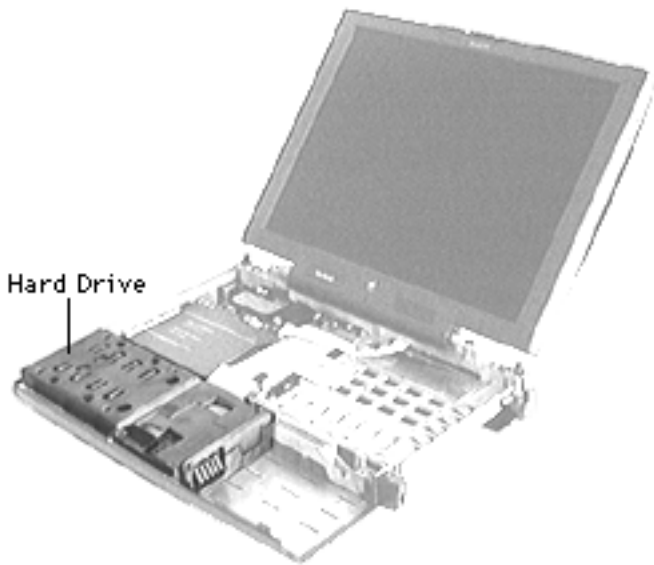

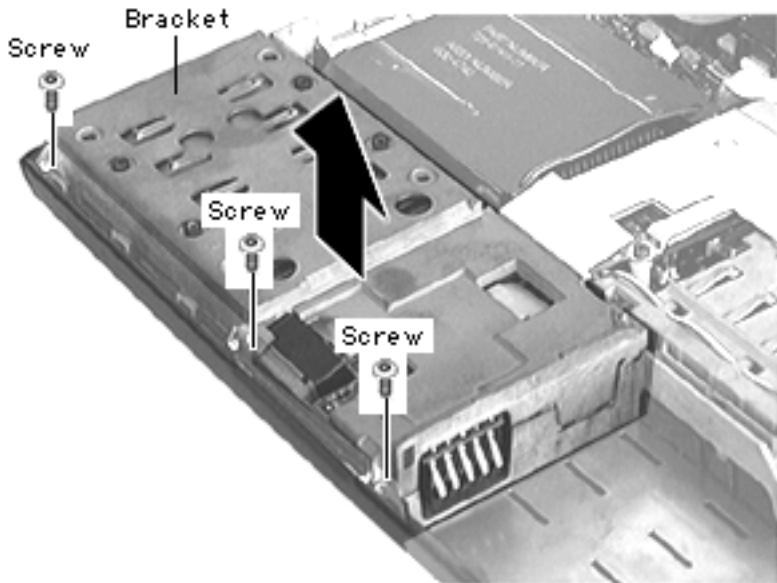

- 1 Remove the 3 interchangeable screws that connect the hard drive bracket to the CPU stiffener.
- 2 Lift up the bracket until you feel a slight resistance. (The hard drive cable is attached to the logic board near the middle of the bracket.)



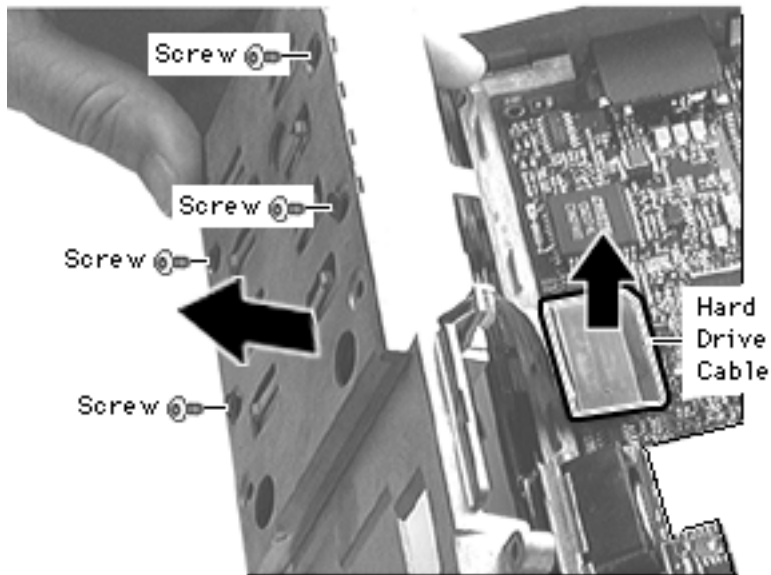

- 3 Turn the hard drive bracket so that it rests in front of the computer.
- 4 Pull the hard drive cable straight up to disconnect it from the logic board.
- 5 Remove the 4 interchangeable screws holding the drive in the bracket.
- 6 Lift off the bracket.



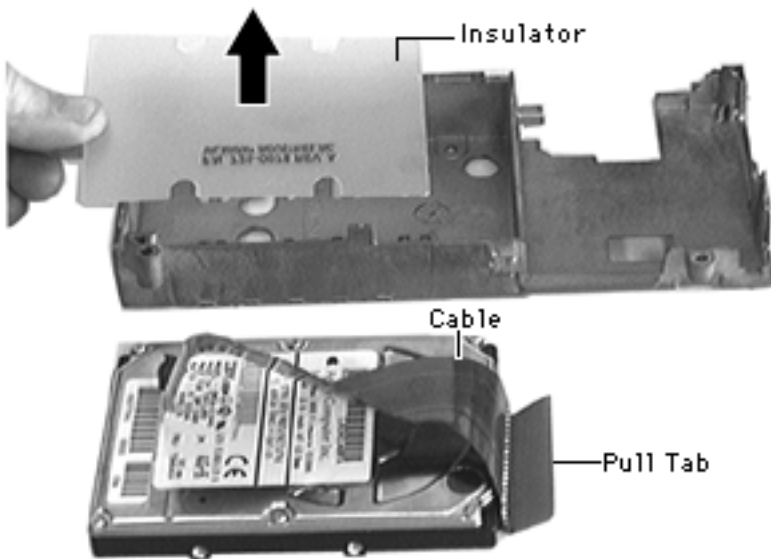

- 7 Remove the hard drive insulator.
- 8 Using the pull tab, disconnect the cable from the hard drive

**Note:** Once you remove the hard drive, the computer will be top-heavy. To prevent the unit from tipping backwards, do one of the following:

- Set the removed battery at a 45° angle over the bottom right corners of the computer.
- Adjust the display so that it sits at an 80° angle.







## Power Supply Board

Before you begin, remove the following:

- Battery
- Floppy or CD-ROM Drive Assembly
- Keyboard
- Brightness & Speaker Grill
- Left & Right Clutch Covers
- Palm Rest
- Hard Drive

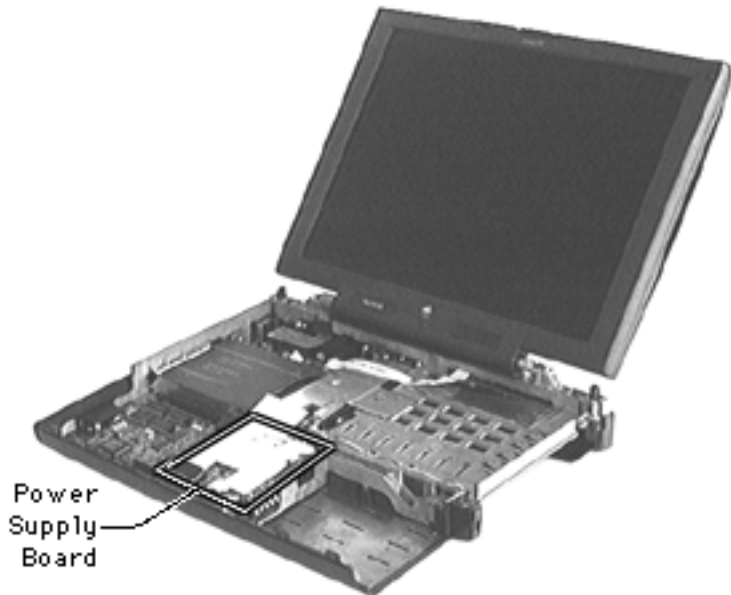

Power  
Supply  
Board



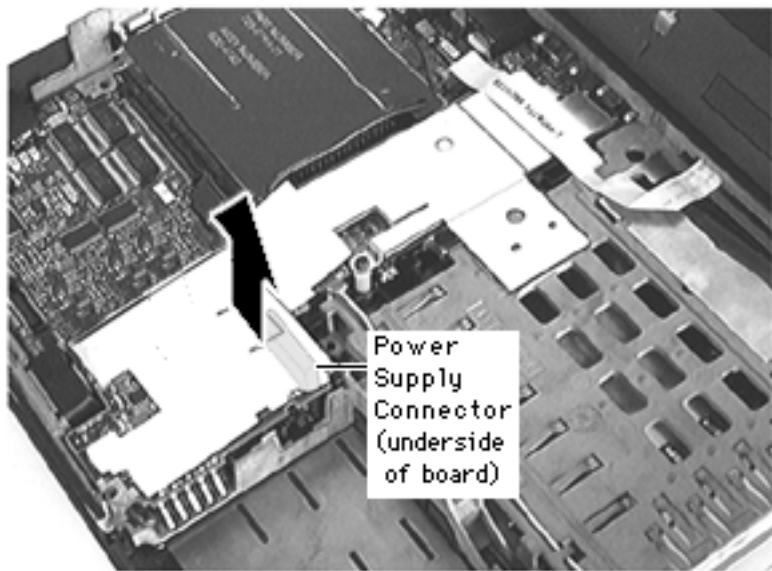

**Note:** The connector is located on the top right side of the power supply board.

- 1 To prevent damage to its connector, grasp the top edges of the power supply board and lift it straight up and off





## Heatsink

Before you begin, remove the following:

- Battery
- Floppy or CD-ROM Drive Assembly
- Keyboard
- Brightness & Speaker Grill
- Left & Right Clutch Covers
- Palm Rest
- Hard Drive
- Power Supply Board



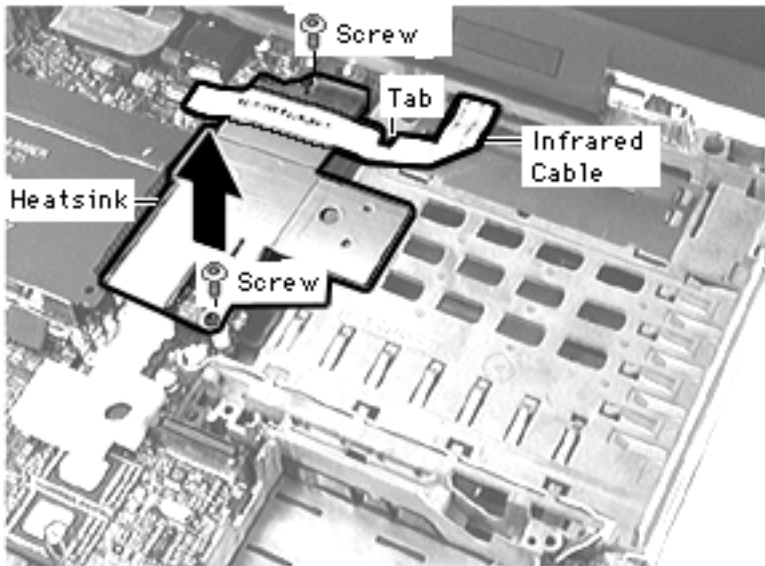

**Note:** The heat transfer sponge on the heatsink is tacky; keep it clean so it does not pick up dust from the workspace.

- 1 Detach the infrared cable from the logic board and slide the cable from under its tab on the CPU stiffener.
- 2 Remove the 2 interchangeable screws from the heatsink.
- 3 Lift the heatsink off and set it aside, insulator side-up.





## Ethernet or Ethernet/Modem Card

Before you begin, remove the following:

- Battery
- Floppy or CD-ROM Drive Assembly
- Keyboard
- Brightness & Speaker Grill
- Left & Right Clutch Covers
- Palm Rest
- Hard Drive
- Power Supply Board

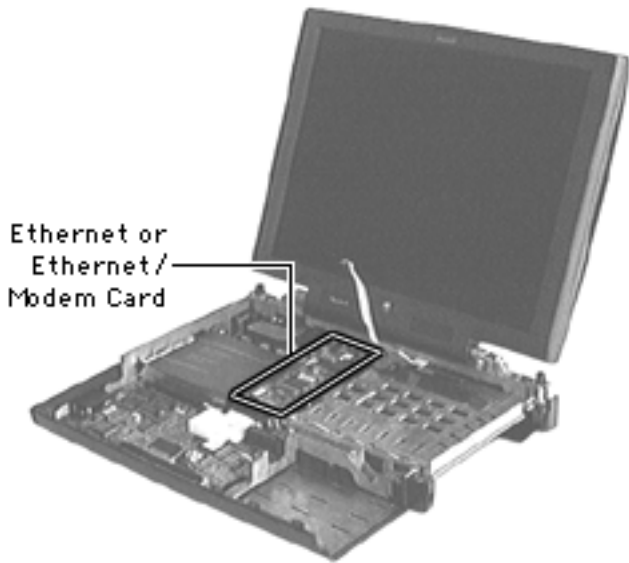

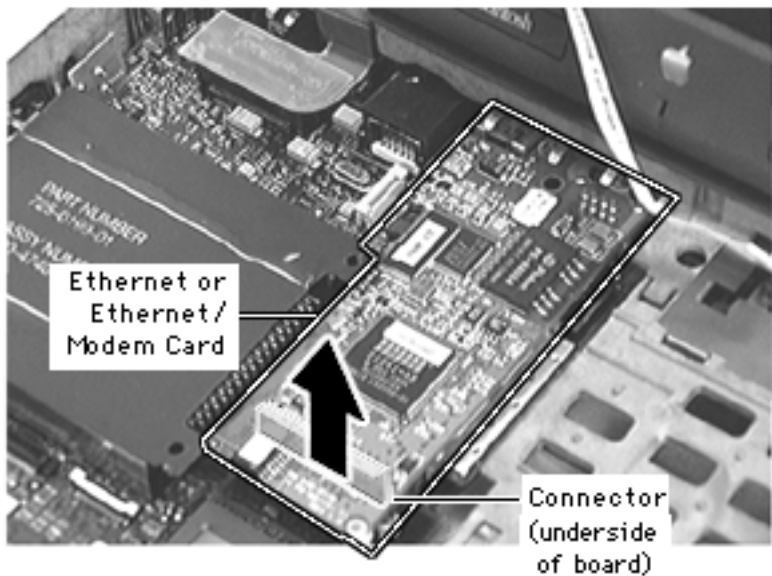

- Heatsink

**Note:** An ethernet card or an ethernet/modem card is installed in this connector; the connector is located near the front of the card.

- 1 To prevent damage to its connector, grasp the ethernet card or ethernet/modem card in front and pull it straight up and off.

**Replacement Note:** You must install the standoffs on the logic board before installing this card.





## Logic Board

Before you begin, remove the following:

- Battery
- Floppy or CD-ROM Drive Assembly
- Keyboard
- Brightness & Speaker Grill
- Left & Right Clutch Covers
- Palm Rest
- Hard Drive
- Power Supply Board
- Heatsink
- Ethernet or Ethernet/Modem Card

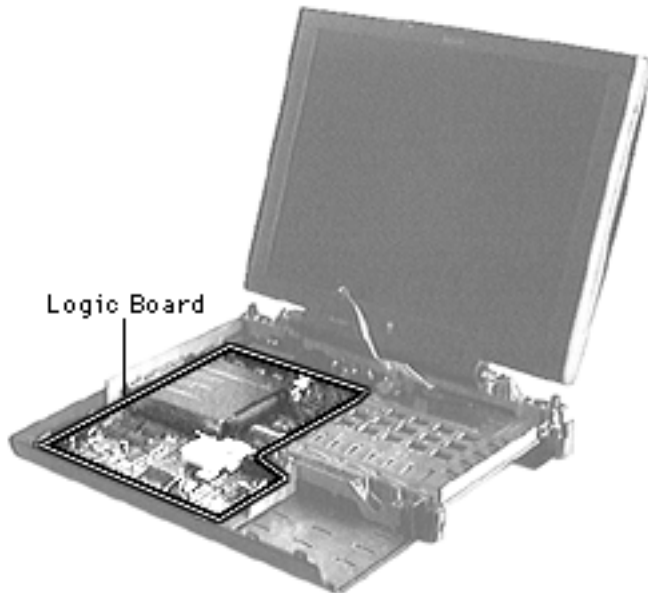

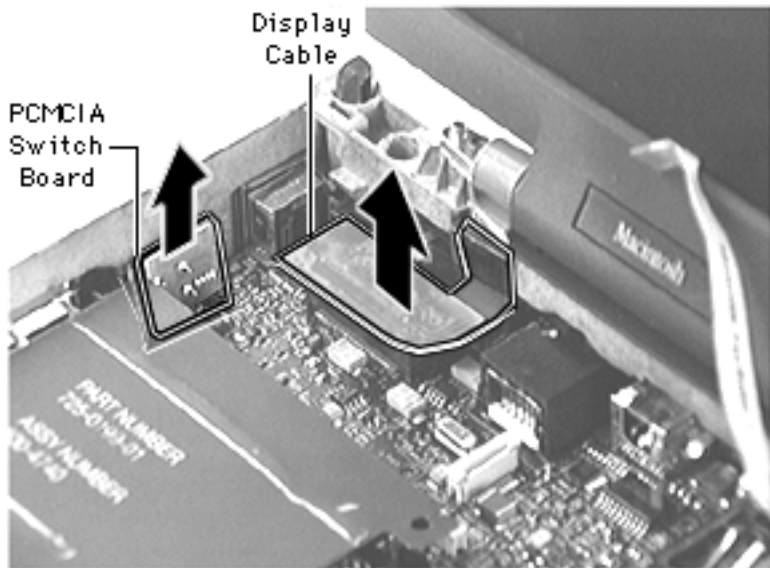

- 1 Disconnect the display cable.
- 2 To avoid damage to its pins, lift the PCMCIA switch board straight up and off.





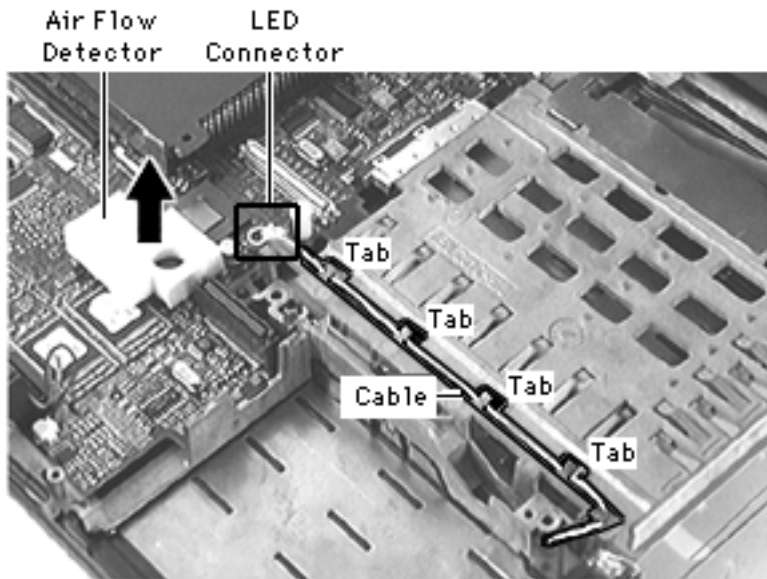

- Using your fingers, disconnect the LED connector and gently guide the cable out of its 5 tabs on the CPU stiffener.
- Lift off the air flow deflector, if present. (Note: The PowerBook G3 does not include an air flow deflector.)



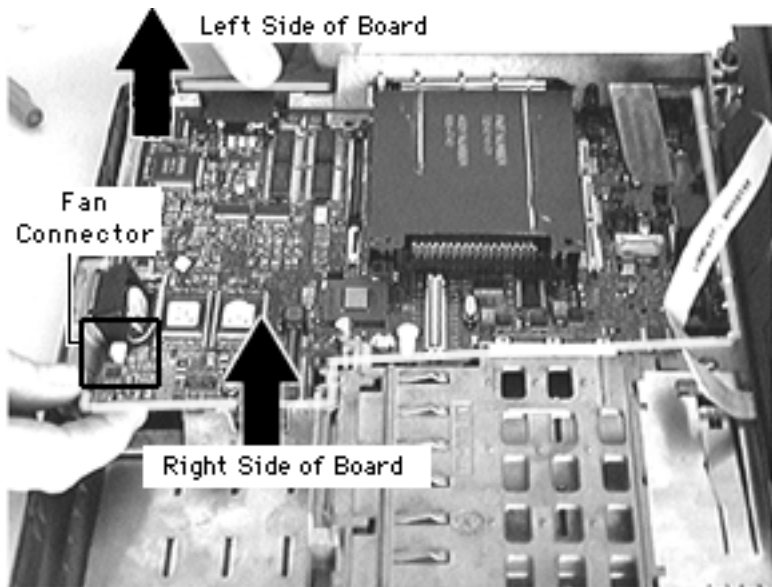

- 5 Using your fingers, disconnect the fan connector.
- 6 Slightly pull out the left side of the bottom case to free the logic board.
- 7 Grasp the right corner of the board and lift it up and out.



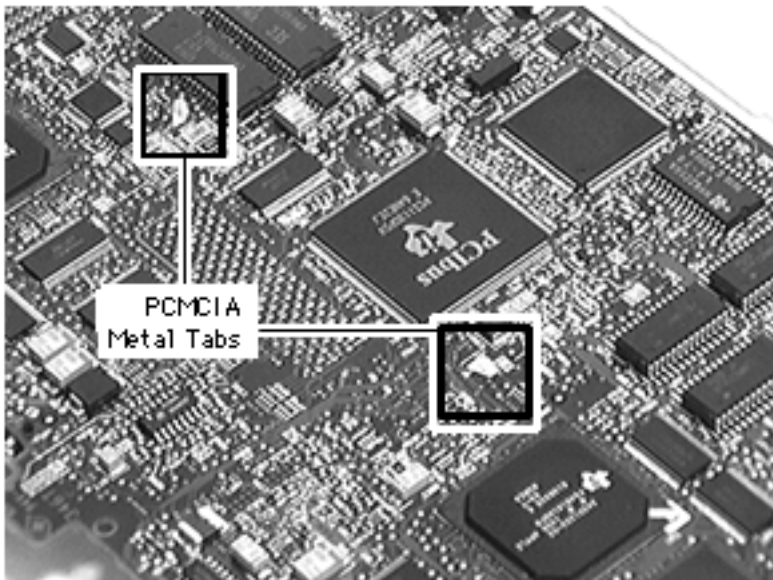

**Note:** This step is not necessary for further take-apart.

- 8 On the underside of the logic board, disengage the 2 tabs on the PCMCIA shield and lift off the shield.

**Replacement Note:** The pins on the PCMCIA switch board are easily bent; install the board carefully.





## CPU Stiffener

Before you begin, remove the following:

- Battery
- Floppy or CD-ROM Drive Assembly
- Keyboard
- Brightness & Speaker Grill
- Left & Right Clutch Covers
- Palm Rest
- Hard Drive
- Power Supply Board
- Heatsink
- Ethernet or Ethernet/Modem Card

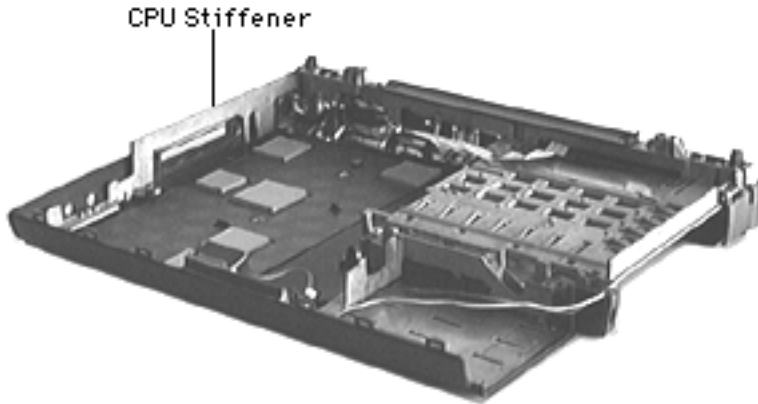



- Logic Board
- Display Assembly

**Note:** The alignment guide assembly consists of a metal expansion bay spacer plate and a plastic expansion bay alignment guide. Its removal is not necessary for further take-apart.

- 1 Insert a flat-blade screwdriver into the opening on the CPU stiffener and slightly lift up the alignment guide assembly.
- 2 Using your fingers, slide

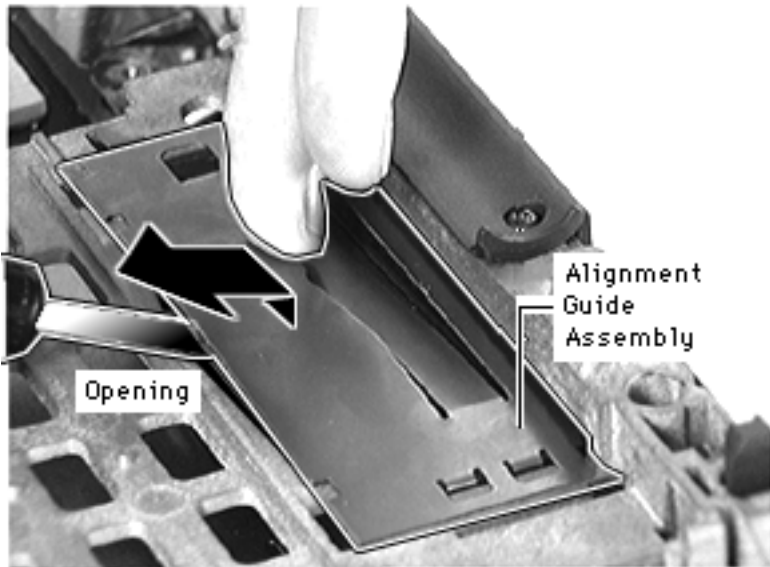



the assembly forward  
and lift it off.

**Note:** Turn the assembly  
around to perform the next  
step

- 3 Holding the 2 pieces  
taut, insert a flat-blade  
screwdriver under the  
metal spacer plate and  
pop off the alignment  
guide.

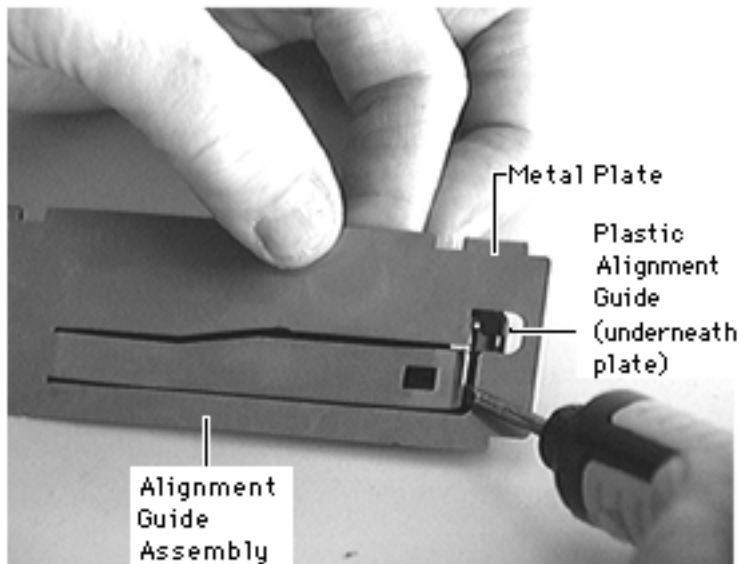

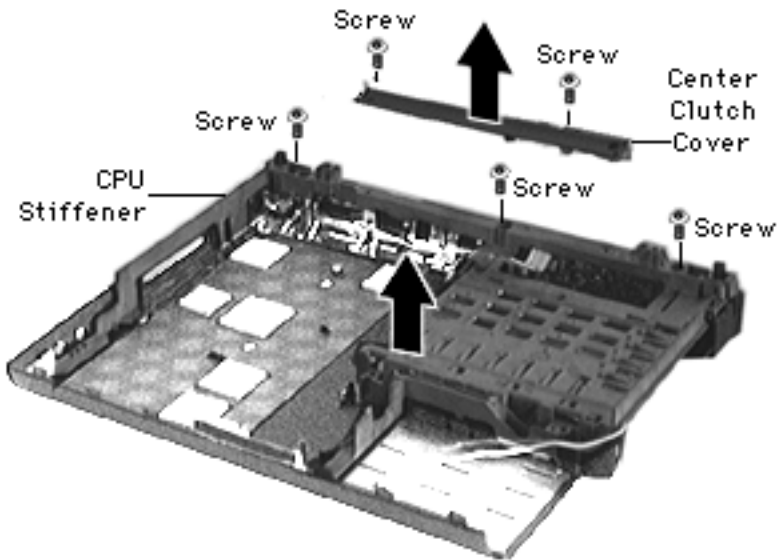

- 4 Remove the 2 interchangeable screws from the center clutch cover.
- 5 Remove the 3 interchangeable screws from the CPU stiffener.
- 6 Lift off the CPU stiffener.

- 7 Using your finger, push





in the foot lever on each  
foot and release it

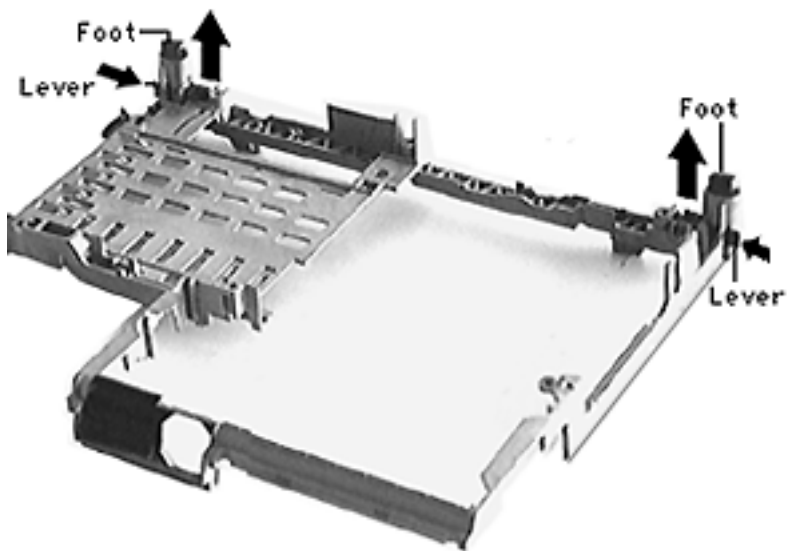



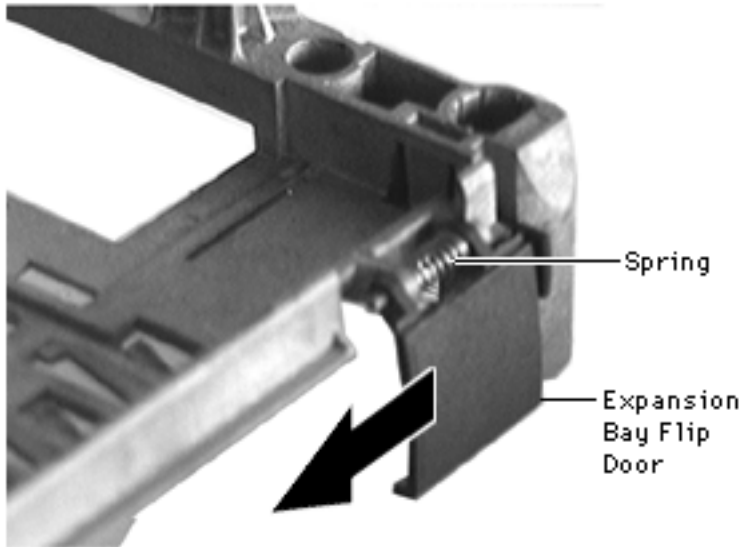

- 8 Slide the expansion bay flip door forward and gently remove the door and its spring.

**Replacement Notes:**

- With the space plate's notched side facing down, install the alignment guide onto the plate.
- Slide the alignment guide assembly onto the CPU stiffener.
- Install the expansion bay flip door (without the





spring) onto the CPU stiffener. Holding it in place, pop the spring onto the 2 door tabs.

- Insert the foot/spring assembly into its opening on the CPU stiffener. Holding in the release lever, push in the foot/spring assembly as far as it will go. Letting go of the release lever locks the assembly into place.
- Before installing the stiffener, make sure 1) the LED cable is out of the way and 2) the I/O shield, infrared board, and infrared window are correctly aligned.





## Infrared Window & Board

Before you begin, remove the following:

- Battery
- Floppy or CD-ROM Drive Assembly
- Keyboard
- Brightness & Speaker Grill
- Left & Right Clutch Covers
- Palm Rest
- Hard Drive
- Power Supply Board
- Heatsink

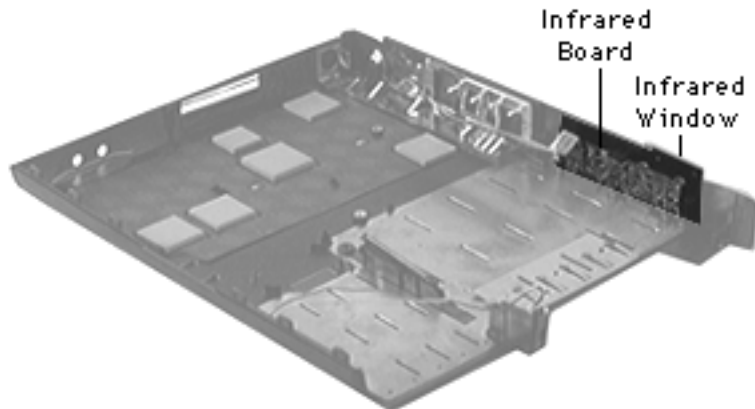

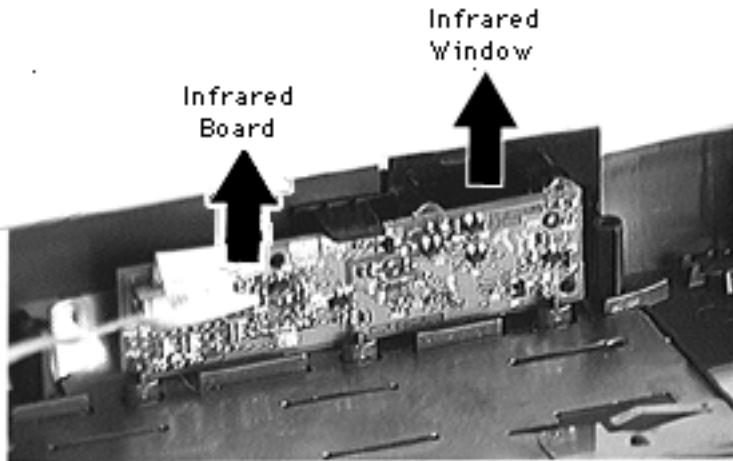

- Ethernet or Ethernet/Modem Card
- Logic Board
- Display Assembly
- CPU Stiffener

**Note:** The infrared board falls out when you remove the infrared window.

- 1 Lift the infrared window off the bottom case.
- 2 Remove the infrared board from the bottom case.





- 3 Disconnect the infrared cable from the board.

**Replacement Notes:**

- Do not leave fingerprints on the infrared window. Before installing it, clean it with a soft, lint-free cloth.
- With its notched side down, install the infrared window into its slot on the bottom case.
- Before installing the infrared board, install its cable.
- With its notched side down, angle the board

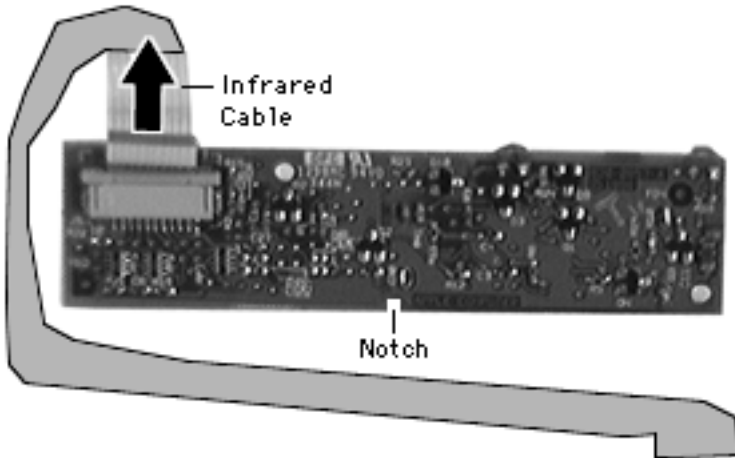



onto its 3 holding tabs on the bottom case. Align the notch with the center tab and push the board back until it snaps into place underneath the window tab.

- Before installing the CPU stiffener onto the bottom case, thread the infrared cable up through the stiffener and hold the infrared window in place.





## Media Bay LED & Release Mechanism

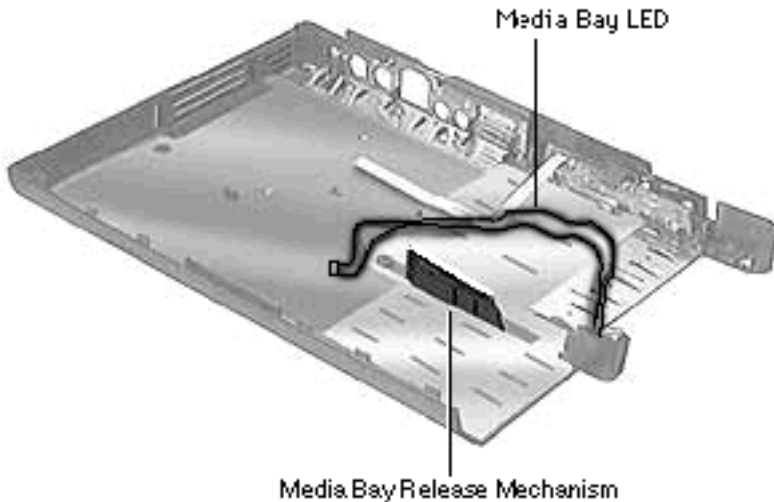

Before you begin, remove the following:

- Battery
- Floppy or CD-ROM Drive Assembly
- Keyboard
- Brightness & Speaker Grill
- Left & Right Clutch Covers
- Palm Rest
- Hard Drive
- Power Supply Board



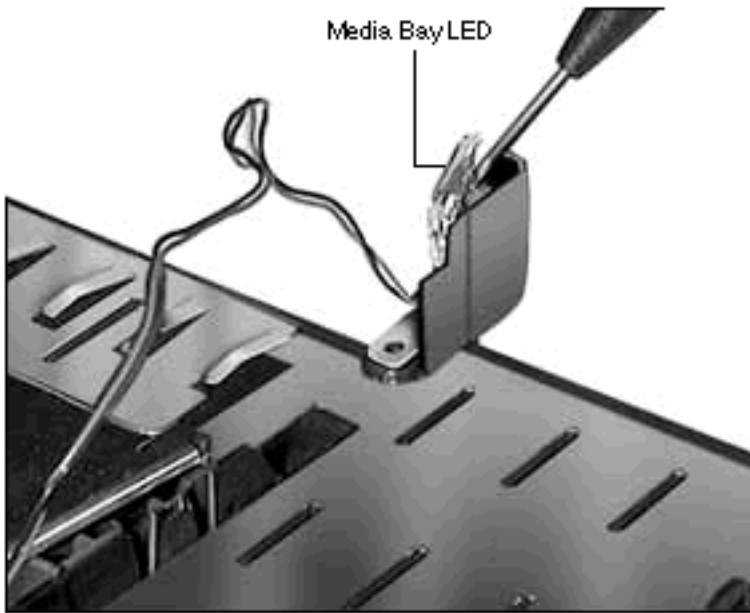

- Heatsink
- Ethernet or Ethernet/Modem Card
- Logic Board
- Display Assembly
- CPU Stiffener

- 1 Insert a flat-blade screwdriver under the media bay crystal and gently pry up until the LED dislodges.





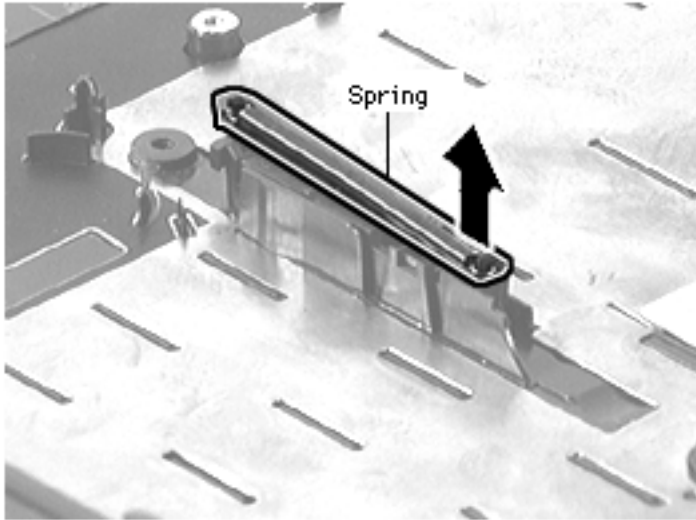

**Note:** The release mechanism assembly consists of a spring and plastic “hook and eye.”

- 2 Remove the spring from the top of the media bay release mechanism.



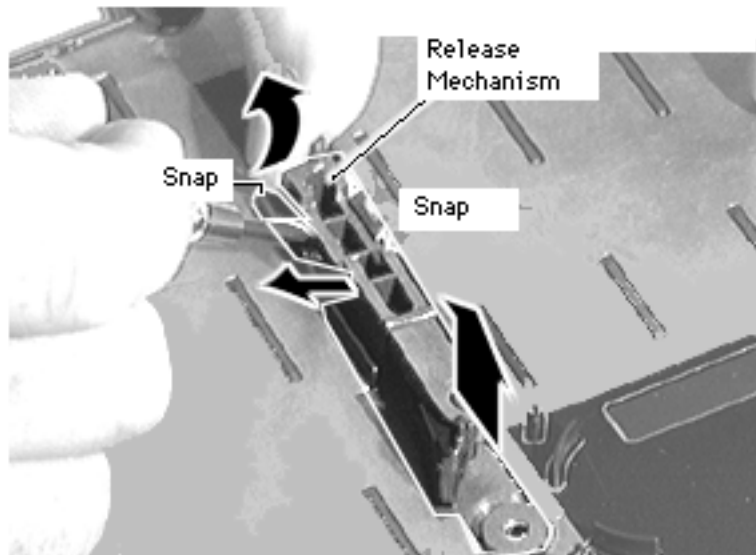

**Caution:** The following step, which frees the tightly installed release mechanism from the bottom case, is difficult to perform. Be careful not to break the plastic snaps.

- 3 Inserting a flat-blade screwdriver between one of the snaps and the release mechanism, carefully but firmly force the snap outwards.
- 4 Pull out the release mechanism.



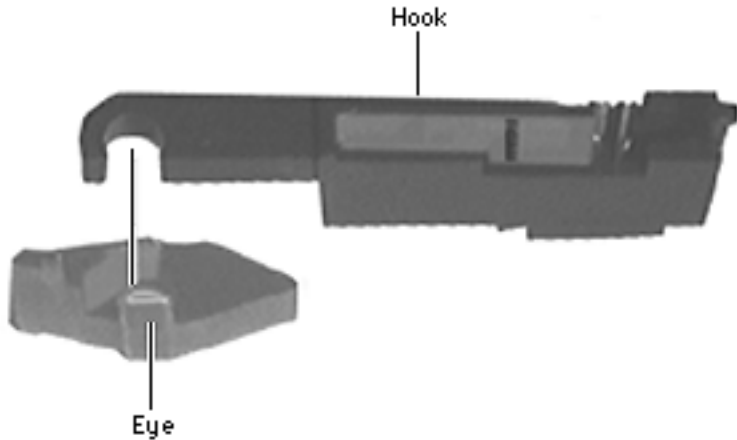

## Mechanism Replacement

### Notes:

- Install the plastic “eye” onto its round notch on the bottom case.
- Align the plastic “hook” with the “eye” and snap it into place on the bottom case.
- Install the spring onto its 2 pins on the release mechanism.

### Cable Replacement Note:

Gently bend the LED cable to the right so that its connector rests outside the bottom case. This will allow





the cable to clear the stiffener as the stiffener is installed.





## ADB Door

No preliminary steps are required.

ADB  
Door



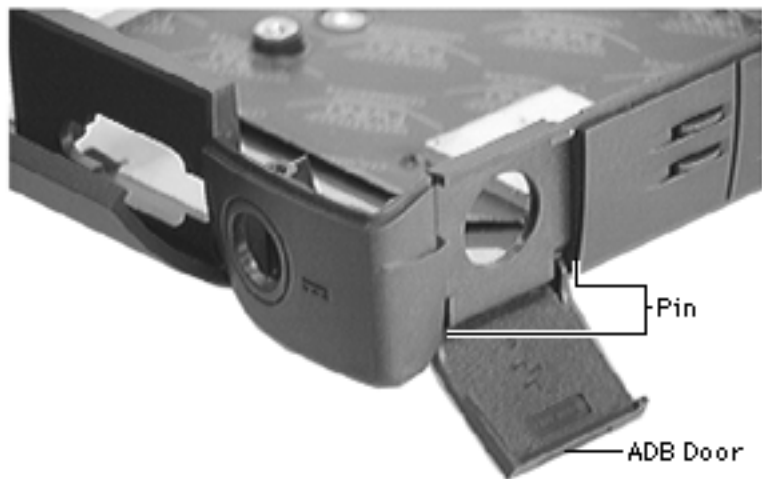

1 Open the ADB door.

**Note:** The ADB door is held in place by 2 pins on the bottom case.

2 Unhinge one side of the door, then the other.

3 Lift off the door.





## I/O Door

No preliminary steps are required.

.



I/O Door



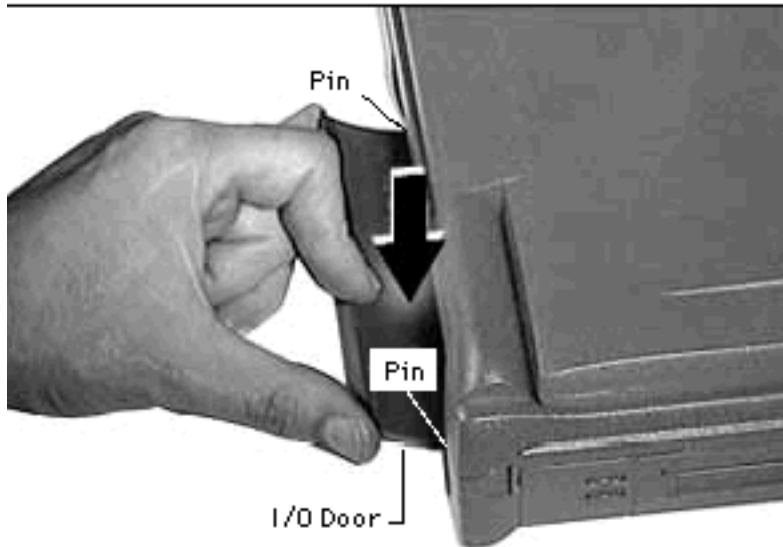

**Note:** The I/O door is held in place by 2 pins on the bottom case.

- 1 Placing a finger on each side of the open I/O door and one finger in the middle of the door, gently bend the door until the middle bows out.
- 2 Unhinge one side of the door.
- 3 Lift the door from the remaining hinge.







## Front Feet

No preliminary steps are required.

**Note:** Removing the front feet is not necessary for further take-apart.



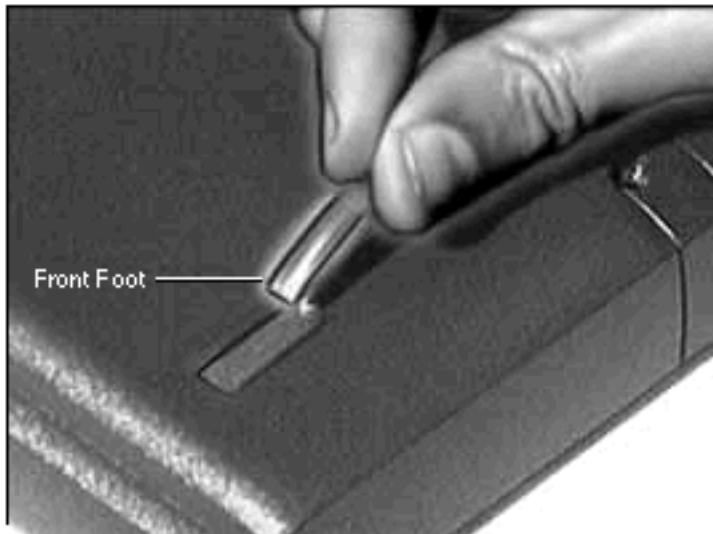

- 1 With a flat-blade screwdriver, pry up and remove the feet from the grooves in the bottom case.





## Bottom Case

Before you begin, remove the following:

- Battery
- Floppy or CD-ROM Drive Assembly
- Keyboard
- Brightness & Speaker Grill
- Left & Right Clutch Covers
- Palm Rest
- Hard Drive
- Power Supply Board
- Heatsink
- Ethernet or Ethernet/Modem Card

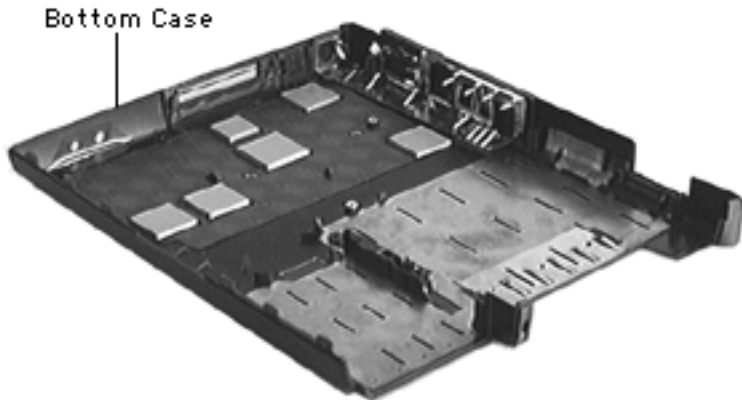

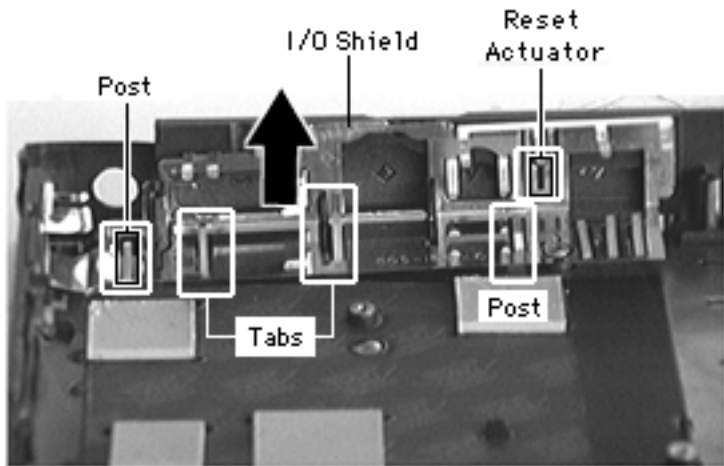

- Logic Board
- Display Assembly
- CPU Stiffener
- Infrared Window & Board
- Media Bay LED & Release Mechanism
- ADB Door
- I/O Door

**Note:** The I/O shield sits on 2 posts and 2 slotted tabs.

- 1 Lift off the I/O EMI shield.
- 2 Slide the reset actuator up and off the I/O shield.





## Floppy Drive

Before you begin, remove the following:

- Floppy Drive Assembly



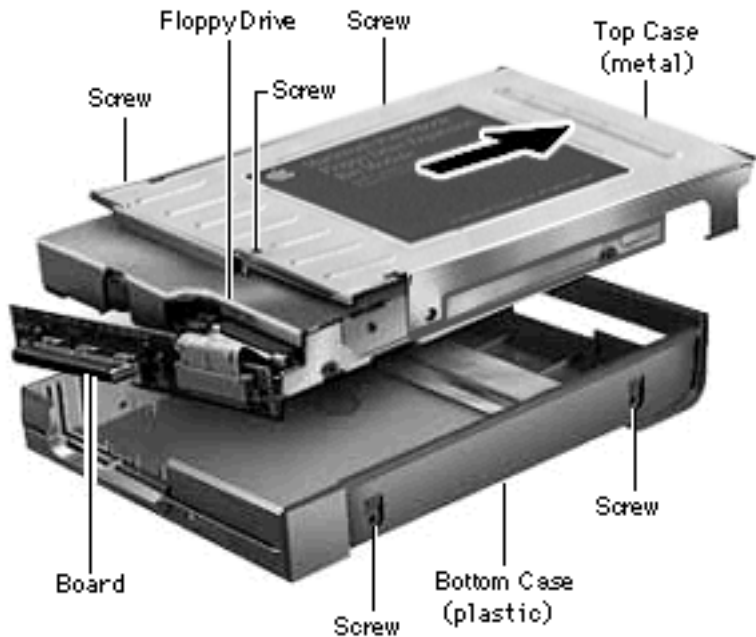

- 1 Using a #6 torx driver, remove the 5 screws from the floppy drive assembly.
- 2 Lift the floppy drive out of the bottom case.
- 3 Slide the metal top case off the floppy drive.





- Using a dental pick, disconnect the floppy drive cable from the floppy drive and the floppy drive board.

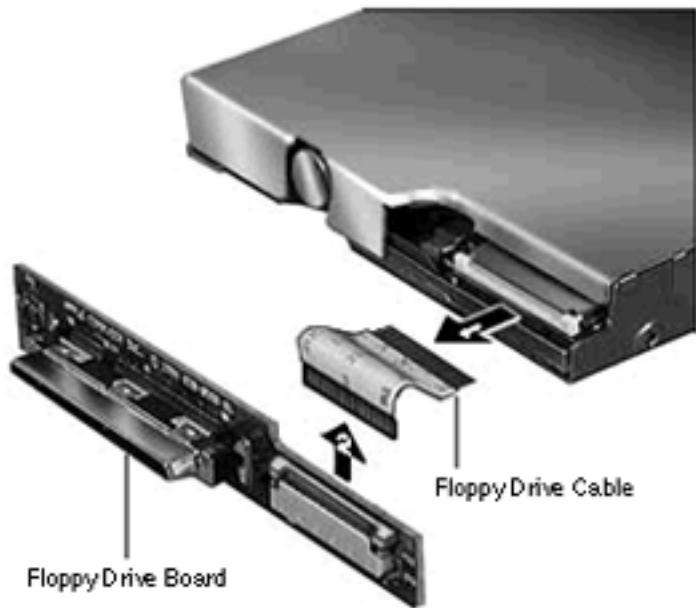

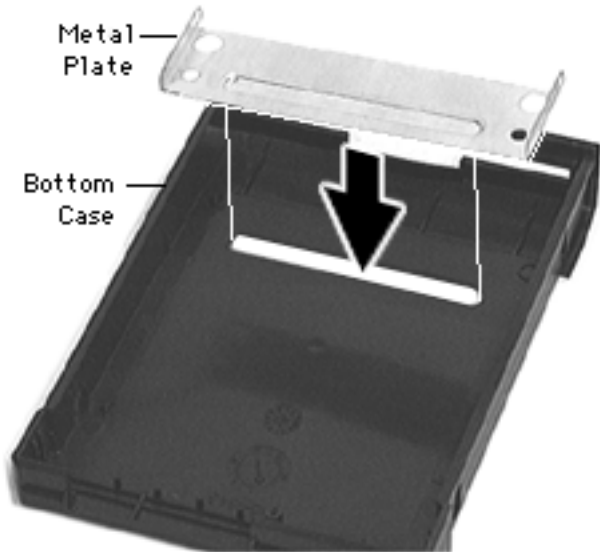

**Replacement Notes:**

- Make sure the metal plate is seated on the bottom case.





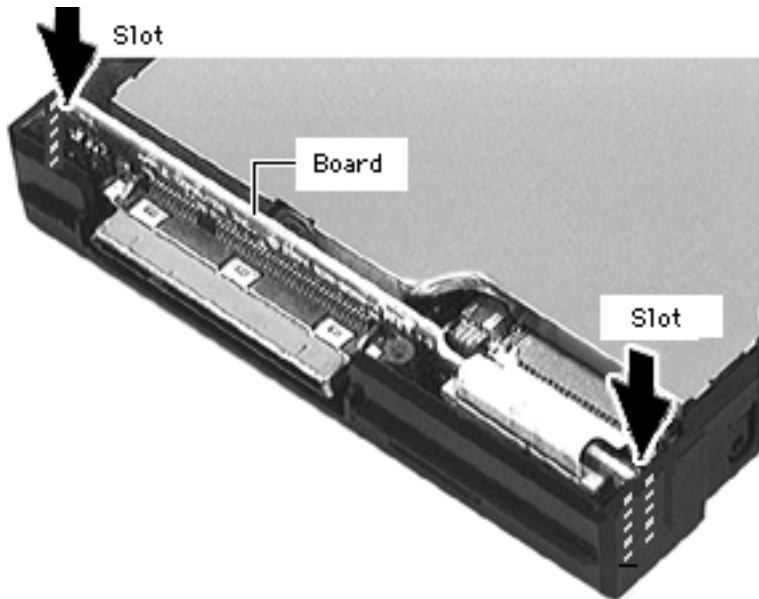

- Install the top case.
- Install both ends of the cable into its connectors.
- Holding the assembly components tightly together, slide the board into its slot and the drive into the bottom case.
- Install the 5 screws.





## Display Assembly

Procedures for removing parts from the display assembly are detailed on the following pages.





## Display Assembly

Before you begin, remove the following:

- Battery
- Floppy or CD-ROM Drive Assembly
- Keyboard
- Left & Right Clutch Covers
- Brightness & Speaker Grill





- 1 Gently disconnect the display cable from the logic board.

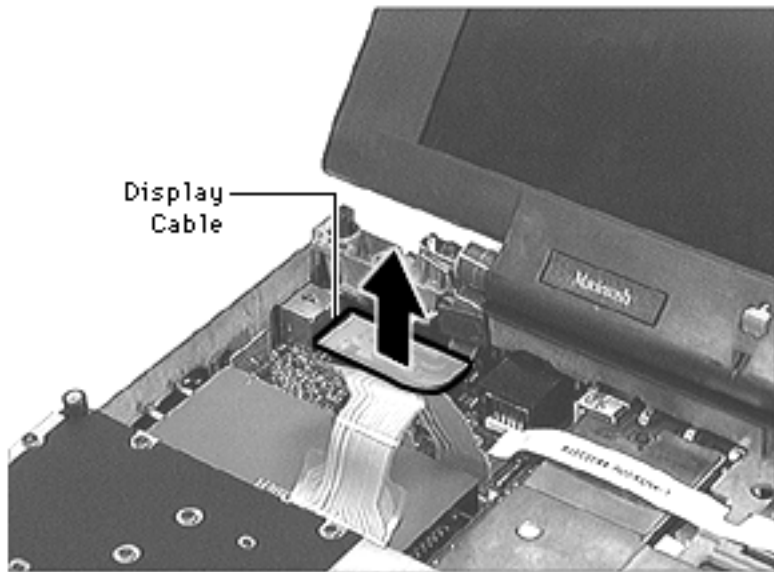

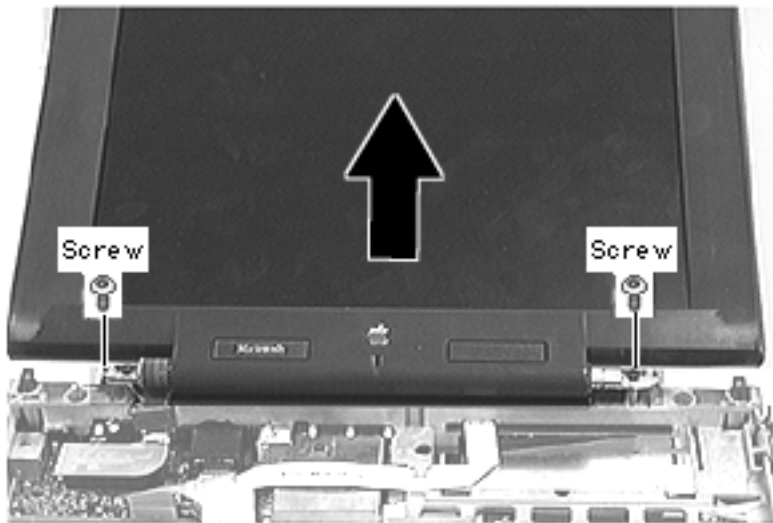

- 2 Remove the 2 interchangeable screws from the metal clutches.
- 3 Lift off the display assembly.

**Replacement Note:**

- To prevent tearing the display cable, make sure the screw hole on the cable aligns with the screw hole on the clutch.
- Perform this test to confirm you installed the display assembly correctly: Try to insert a 3.5" diskette between the closed assembly and the





top case. If you can, this indicates the clutch screws are undertightened. Remove the display assembly and loosen the screws.





## Display Housing

Before you begin, remove the following:

- Battery
- Floppy or CD-ROM Drive Assembly
- Keyboard
- Left & Right Clutch Covers
- Brightness & Speaker Grill
- Display Assembly

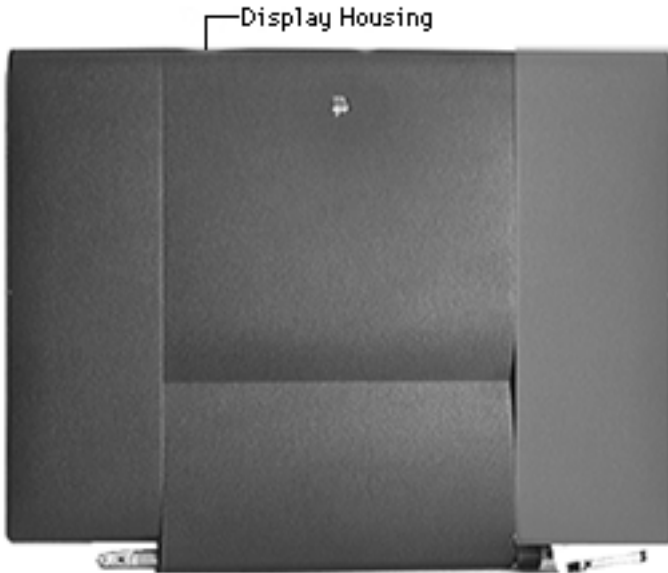



- 1 Using a plastic swizzle stick, remove the 2 product name plates from the bezel.

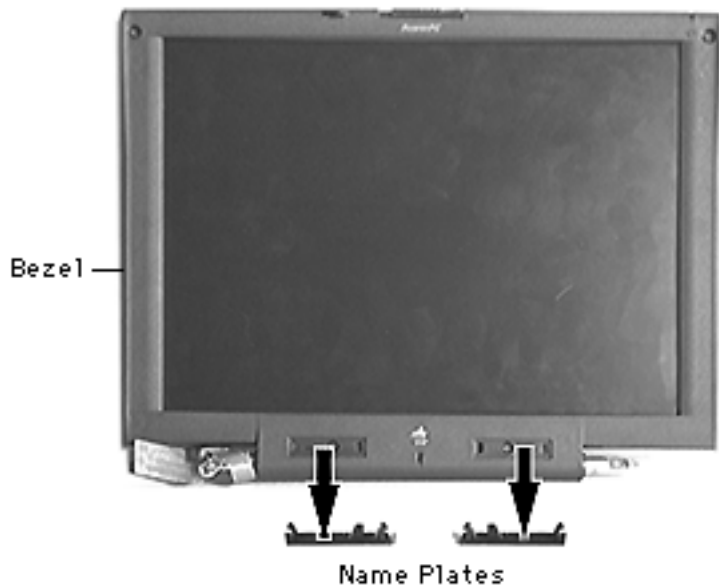





- 2 Remove the 2 bumpers and 4 interchangeable screws from the bezel.

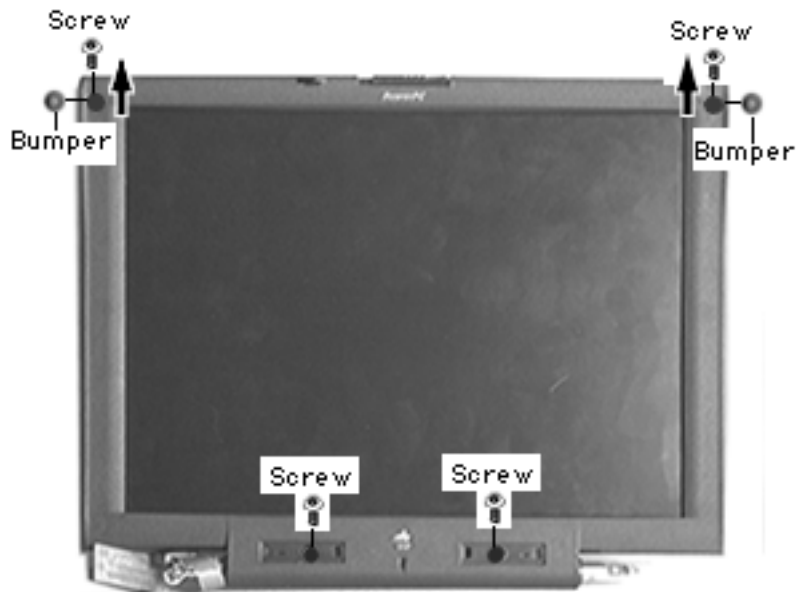

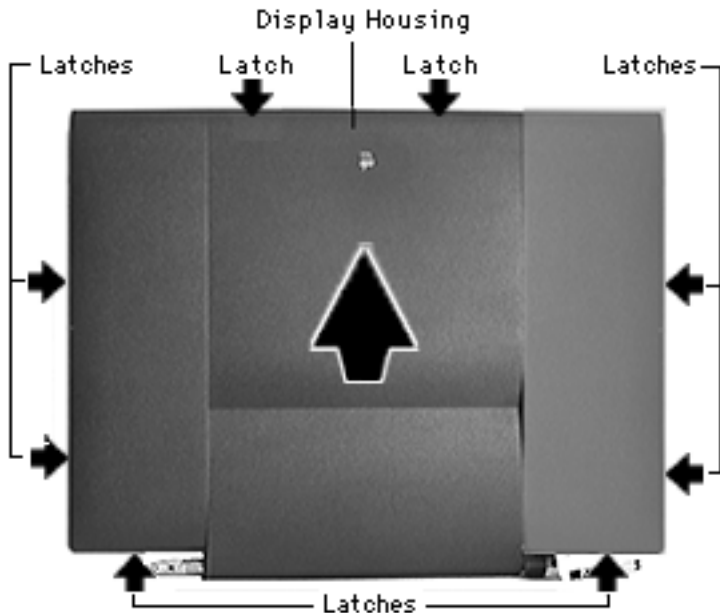

- 3 Starting at the clutch end of the display housing, use a flat-blade screwdriver to carefully pry the plastics apart at the eight inner latch locations.
- 4 Lift off the display housing.



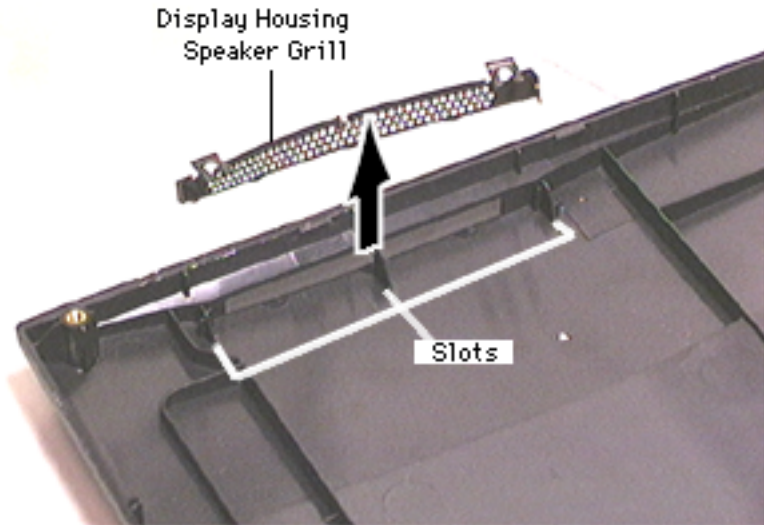

**Note:** Removal of the speaker grills, which are not interchangeable, is not necessary for further take-apart.

- 5 Lift the right and left speaker grills out of their slots on the housing.

**Replacement Note:** Angle the display housing onto the bezel. As you lower the housing into place, snap in the side latches, then the bottom latches.





## Latch

Before you begin, remove the following:

- Battery
- Floppy or CD-ROM Drive Assembly
- Keyboard
- Left & Right Clutch Covers
- Brightness & Speaker Grill
- Display Assembly
- Display Housing

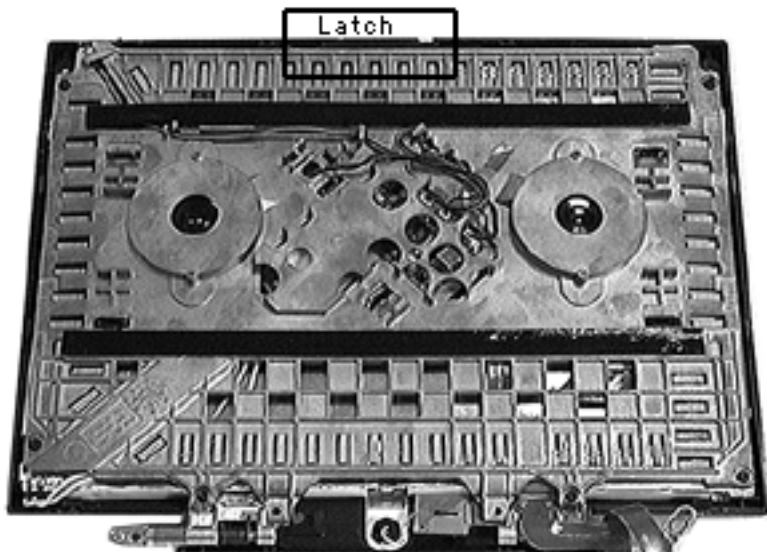

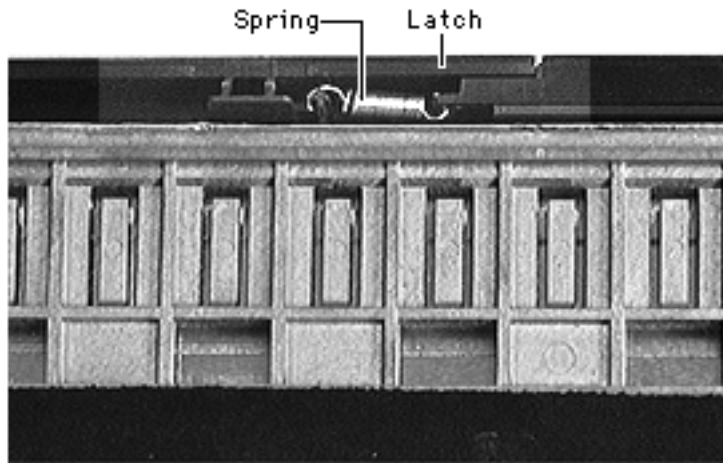

**Note:** It's a good idea to remove the latch any time you're working inside the display assembly. Removal allows the display to lay flat and evenly absorb any pressure exerted when screws are installed.

- 1 Slide the latch and its spring to the right and lift them up and off.





## Display Frame

Before you begin, remove the following:

- Battery
- Floppy or CD-ROM Drive Assembly
- Keyboard
- Left & Right Clutch Covers
- Brightness & Speaker Grill
- Display Assembly
- Display Housing

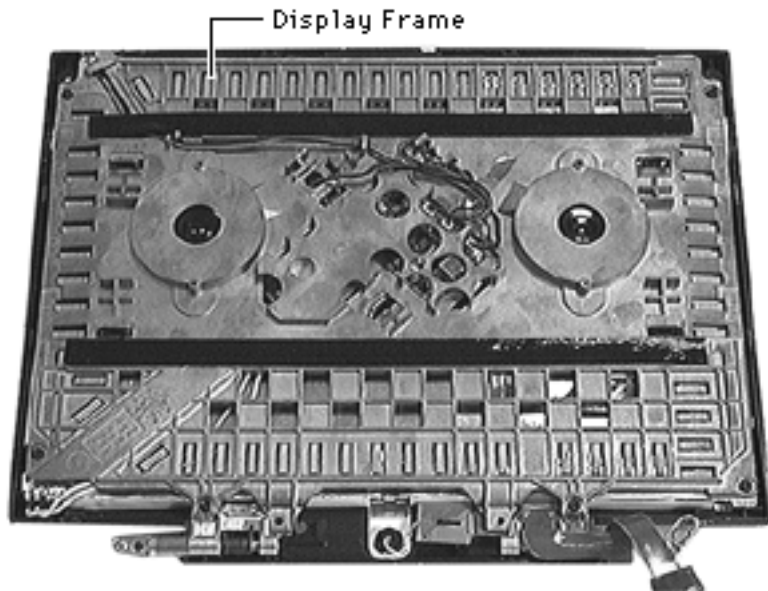



- 1 Remove the 6 interchangeable screws from the display frame.

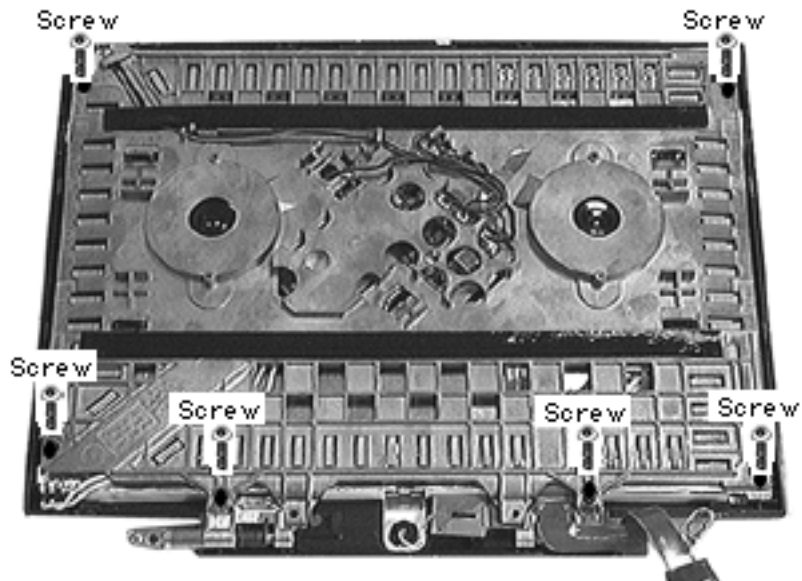

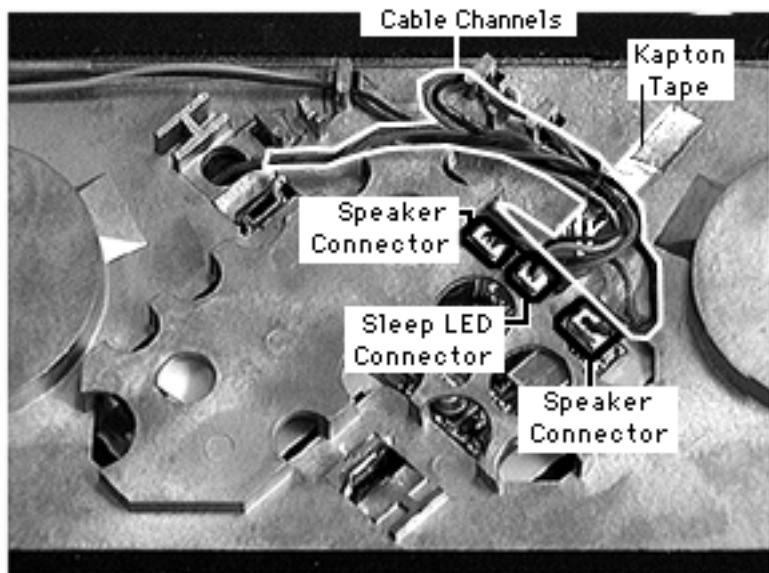

**Note:** The inverter board is located under the display frame; 3 of its connectors must be detached in order to remove the board.

- 2 Using your fingers, disconnect the sleep LED connector.
- 3 Using your fingers, disconnect the 2 speaker connectors.
- 4 Using a swizzle stick, undo and then peel back the kapton tape securing the 3 cables to the display frame.





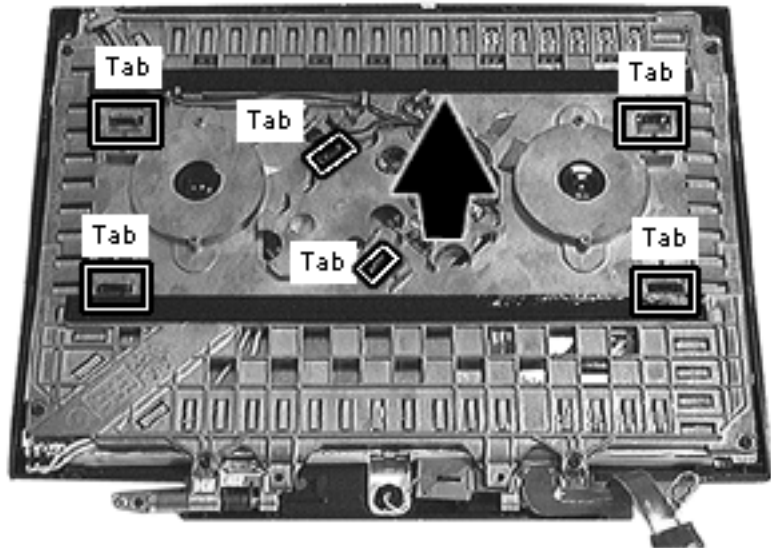

- 5 Using your fingers or a flat-blade screwdriver, release the 6 tabs.
- 6 Lift off the display frame.



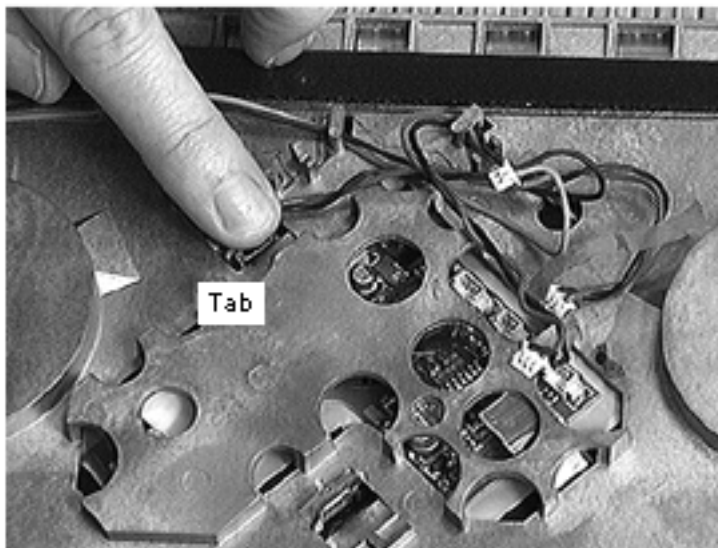

**Replacement Notes:**

- Making sure the connectors are on top of the display frame, set the frame on the display and align the 6 tabs.
- Without applying pressure to the display, gently engage the tabs. Make sure they're fully engaged.





Guide Posts

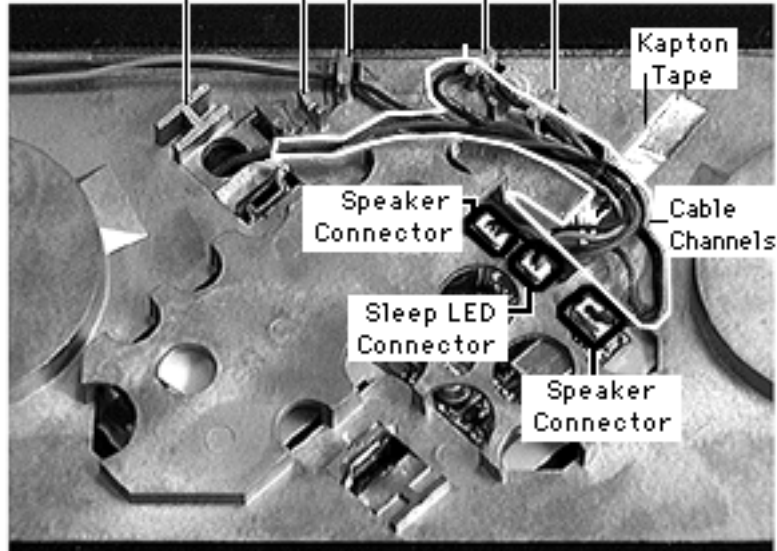

- Wrap the cables around their guide posts and guide them into their channels. Connect the speaker and sleep LED connectors.
- Reattach the kapton tape to secure the 3 sets of wires.
- After checking that the screw holes are still aligned, install the screws in this sequence: top (2), mid-bottom (2), and outer bottom (2).





## Inverter Board

Before you begin, remove the following:

- Battery
- Floppy or CD-ROM Drive Assembly
- Keyboard
- Left & Right Clutch Covers
- Brightness & Speaker Grill
- Display Assembly
- Display Housing
- Display Frame

Inverter Board

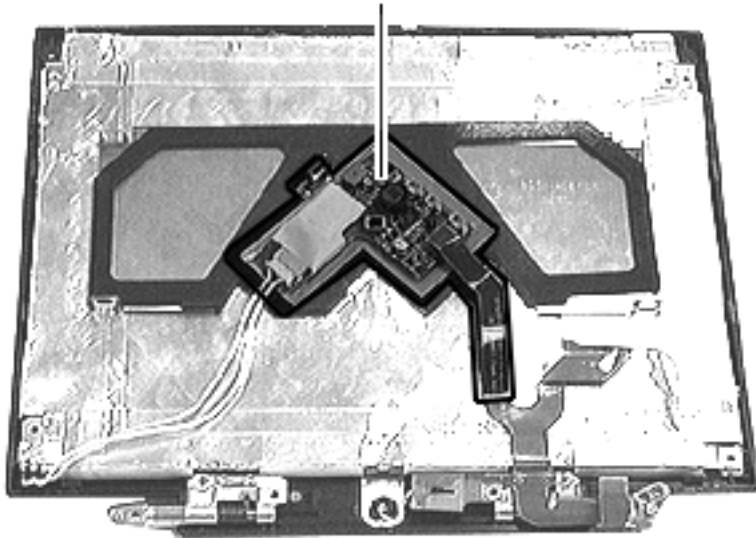



Inverter Frame  
Backlight Connector  
Display Connector

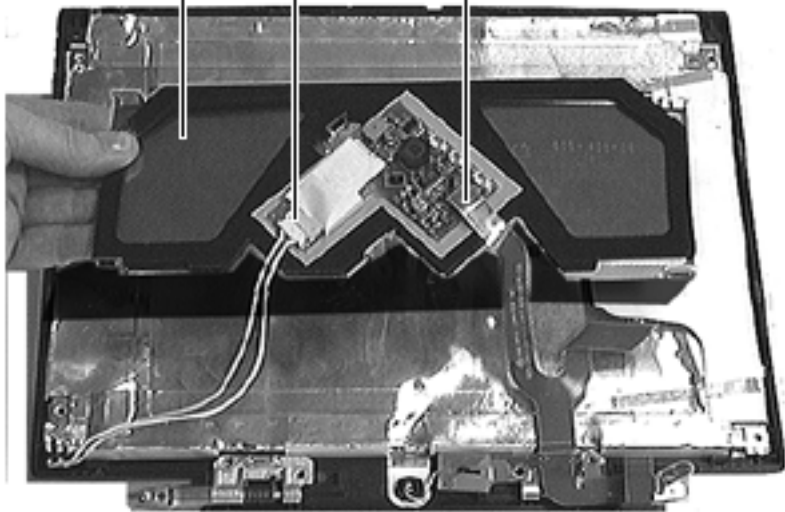

**Note:** Avoid applying pressure to the display, which could cause the screen to crack.

- 1 Raise the inverter frame slightly so that it's not touching the display.
- 2 Using your fingers, disconnect the backlight connector and the display connector.
- 3 Set the inverter frame aside.



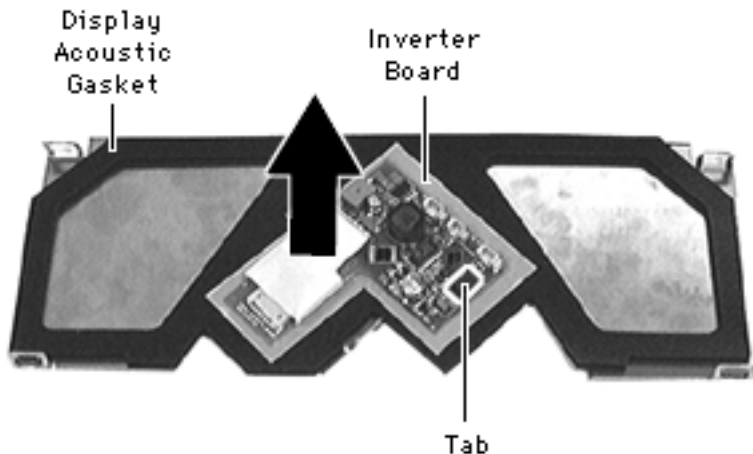

- 4 Using your finger or a flat-blade screwdriver, release the inverter board tab.
- 5 Lift off the inverter board.
- 6 Remove the display acoustic gasket.

**Replacement Notes:**

- Install the display acoustic gasket on the free-standing inverter frame.



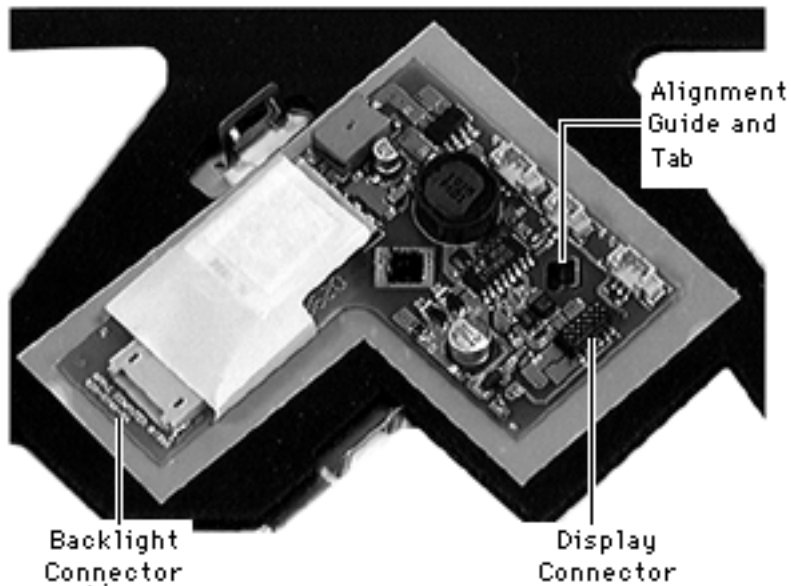

- Install the inverter board onto its alignment guide and engage the tab.
- Holding the inverter frame slightly above the display, connect the backlight and display connectors.
- Carefully set the inverter frame onto the display, making sure the flap on the display shield is closed.



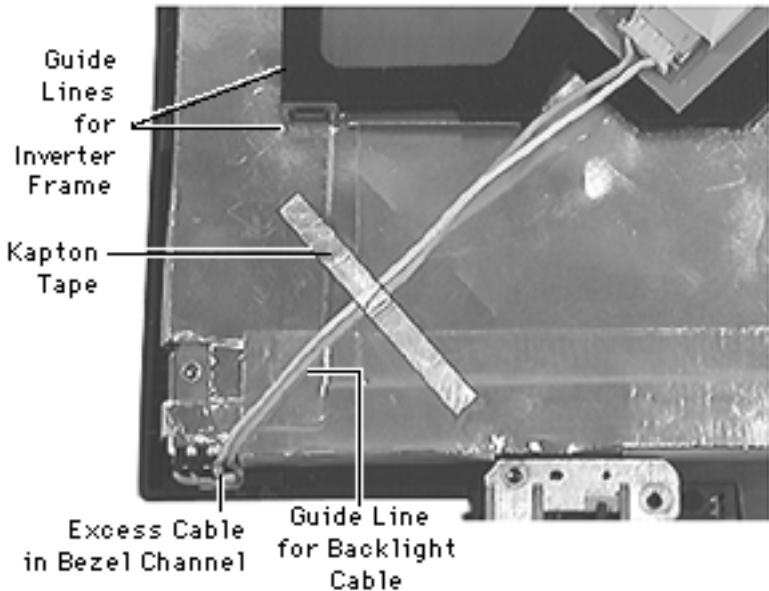

- Precisely align the inverter frame with the “M-shaped” guide line on the display shield.
- Lay the backlight cable within the guide line on the display shield, making sure it lies flat.
- Reattach the kapton tape to the backlight cable, pushing any excess cable into the bezel channel.







## Display Cable

Before you begin, remove the following:

- Battery
- Floppy or CD-ROM Drive Assembly
- Keyboard
- Left & Right Clutch Covers
- Brightness & Speaker Grill
- Display Assembly
- Display Housing
- Display Frame
- Inverter Board

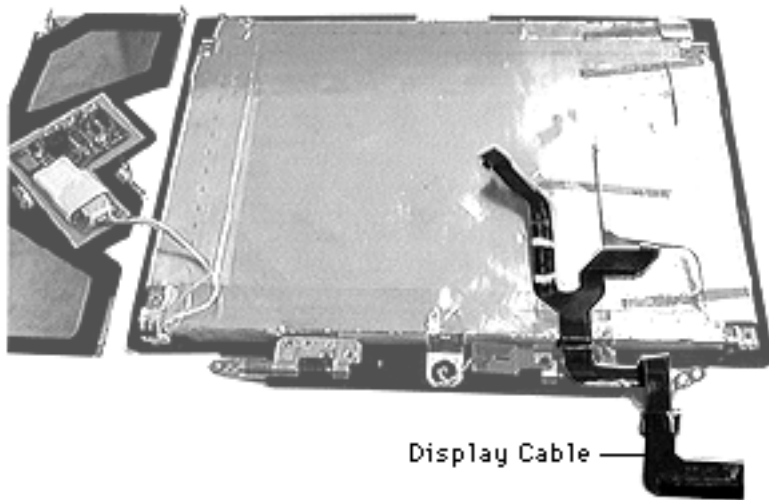

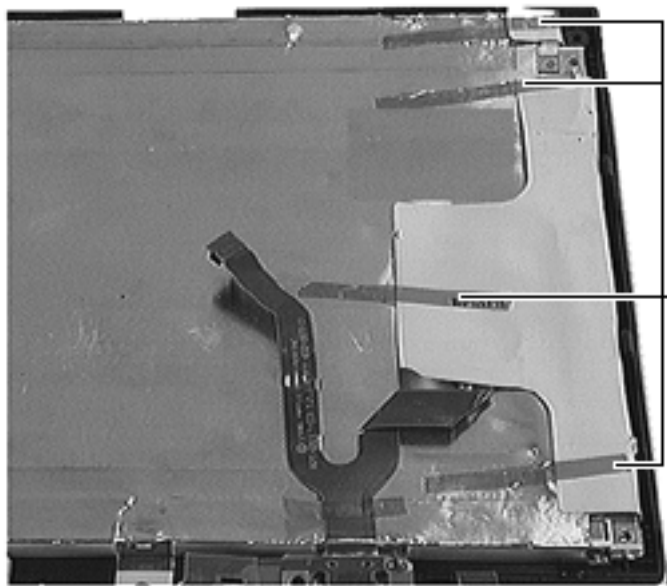

Kapton  
Tape  
(on its  
guide  
lines)

**Note:** For this procedure it is only necessary to disconnect the display cable from the inverter board, not remove the inverter board. (Review the precaution for this step in the Inverter Board chapter.)

**Note:** Because it is difficult to prevent kapton tape from sticking to itself or to aluminum, where specified, do not reuse the tape.

- 1 Using a swizzle stick, pry up the 4 pieces of kapton tape from the flaps of the display



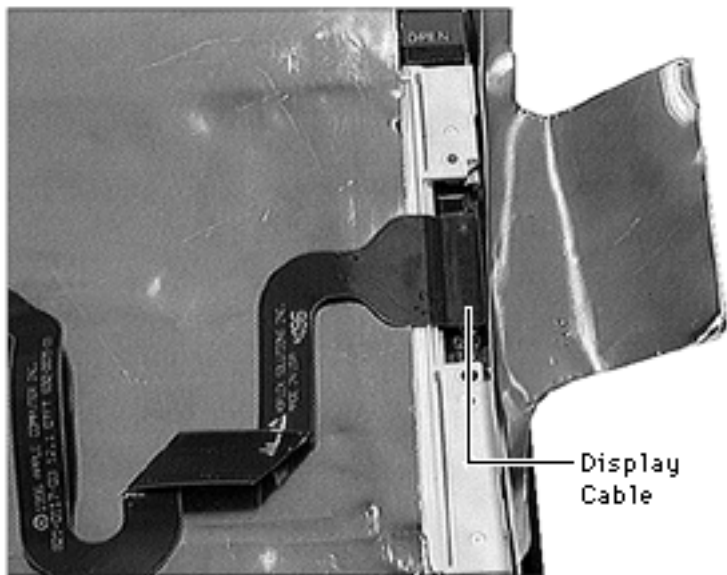

shield.

- 2 Dispose of the tape.
- 3 Disconnect the display cable from the display.

4 Gently pull the



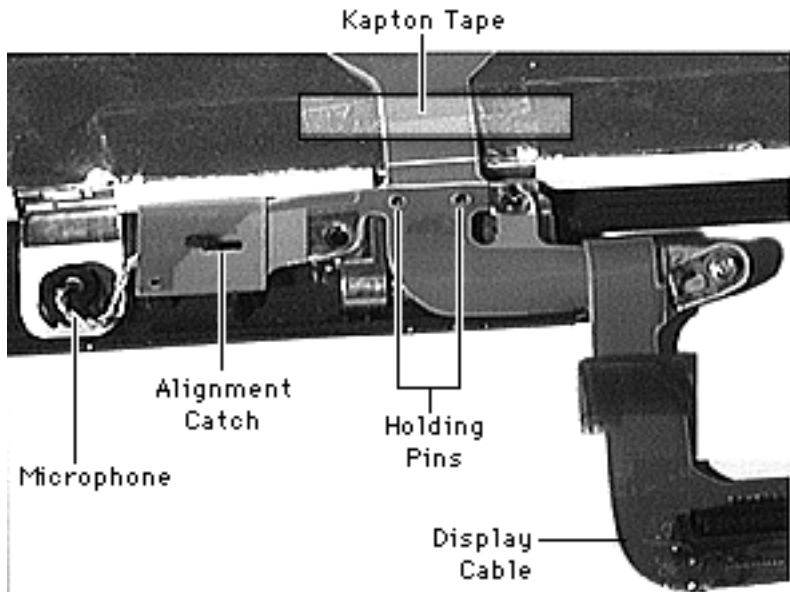

microphone off the bezel.

- 5 Peel back the kapton tape from the “Y” section of the display cable.
- 6 Unwrap the display cable from the right clutch.
- 7 Lift the cable off its two holding pins, slide it to the left, and guide it off the alignment catch.
- 8 Using your fingers,





disconnect the  
microphone from the  
display cable.

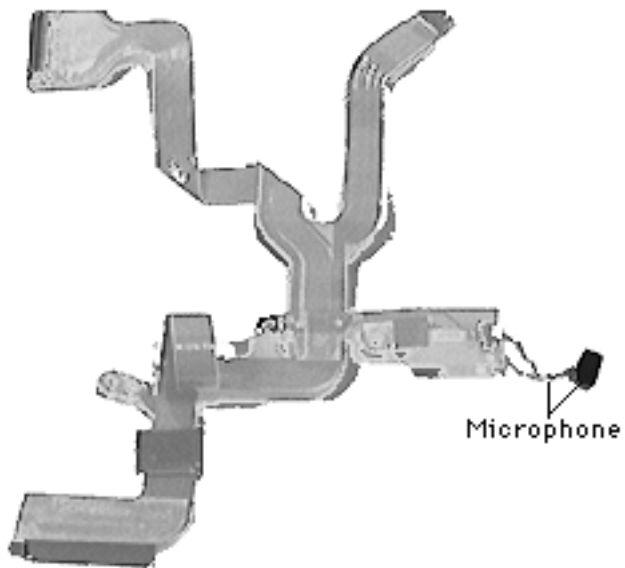



**Replacement Notes:** To ensure that the display is properly seated, reassemble it in the following sequence, noting the precautions.

- Check that the display shield's grounding tabs for the microphone and the clutches are properly seated.
- Install the microphone and attach its connector.
- Install the display cable onto its 2 pins and slide it onto the alignment guide.
- Wrap the display cable around the clutch and seat its grounding tab on the end of the clutch.
- Reattach the kapton tape to the "Y" section of the display cable.
- To prevent damage to the components on the display, lift the bezel up slightly to reduce the load on the display. Then connect the display cable to the display.
- Attach 4 pieces of new kapton tape where indicated by the guide lines on the display shield.





## Display

Before you begin, remove the following:

- Battery
- Floppy or CD-ROM Drive Assembly
- Keyboard
- Left & Right Clutch Covers
- Brightness & Speaker Grill
- Display Assembly
- Display Housing
- Display Frame
- Inverter Board
- Display Cable

Display

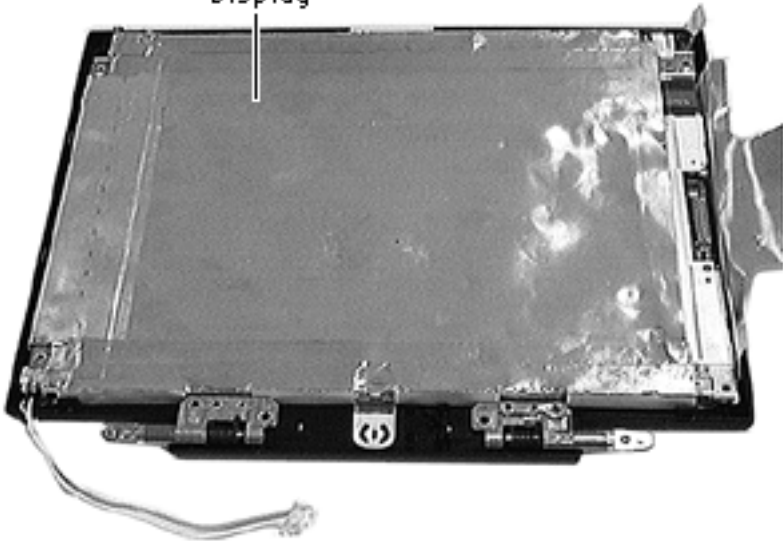

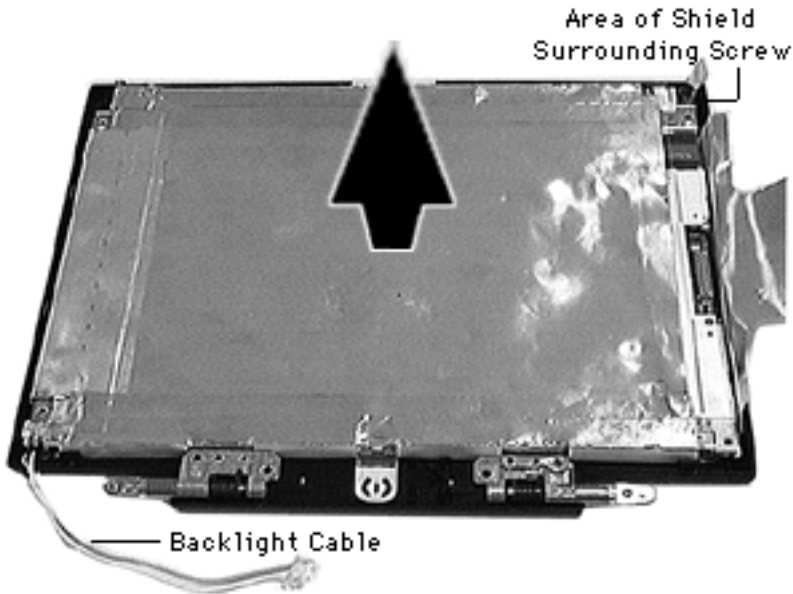

- 1 Remove the display from the bezel.

**Caution:** The upper right corner of the shield surrounding the screw has a thin strip that is easily ripped. Be careful not to tear it as you remove the shield.

- 2 Carefully slide the display out of its shield, guiding the backlight cable so it does not get caught.







**Replacement Notes:**

- Holding the display shield against your chest, slide the display in, guiding the backlight cable through.
- Set the display in the bezel. Turn the bezel over and check that the shield does not show.





## Clutch

Before you begin, remove the following:

- Battery
- Floppy or CD-ROM Drive Assembly
- Keyboard
- Left & Right Clutch Covers
- Brightness & Speaker Grill
- Display Assembly
- Display Housing
- Display Frame
- Inverter Board
- Display Cable

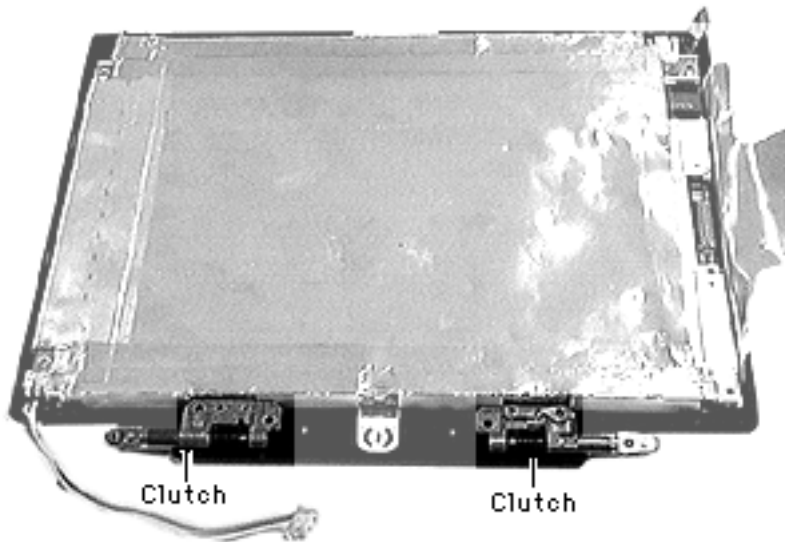

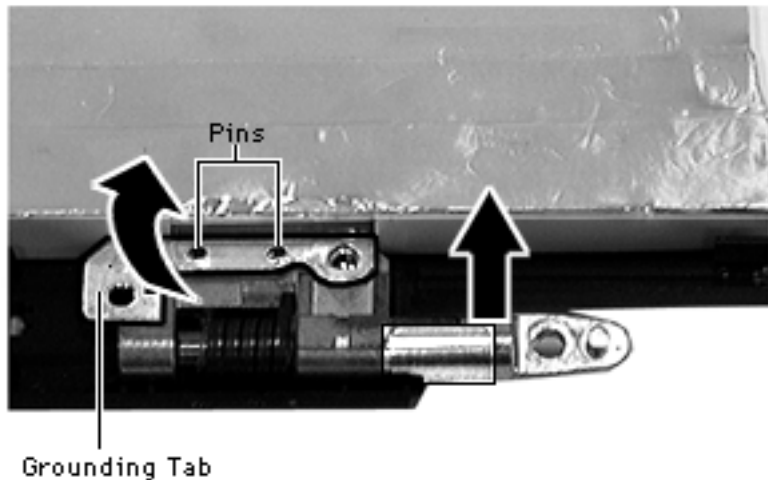

**Note:** For this procedure it is only necessary to disconnect the display cable from the inverter board, not remove the inverter board. (Review the precaution for this removal in the Inverter Board chapter.)

- 1 Carefully fold up the clutch grounding tabs on the display shield.
- 2 Lift each interchangeable clutch off its pins.





## Bezel

Before you begin, remove the following:

- Battery
- Floppy or CD-ROM Mechanism
- Keyboard
- Left & Right Clutch Covers
- Brightness & Speaker Grill
- Display Assembly
- Display Housing
- Display Frame
- Inverter Board
- Display Cable
- Display

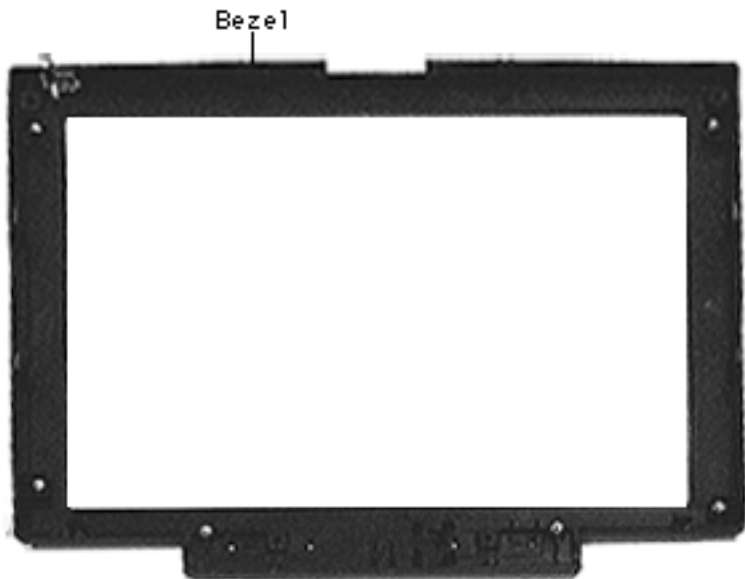

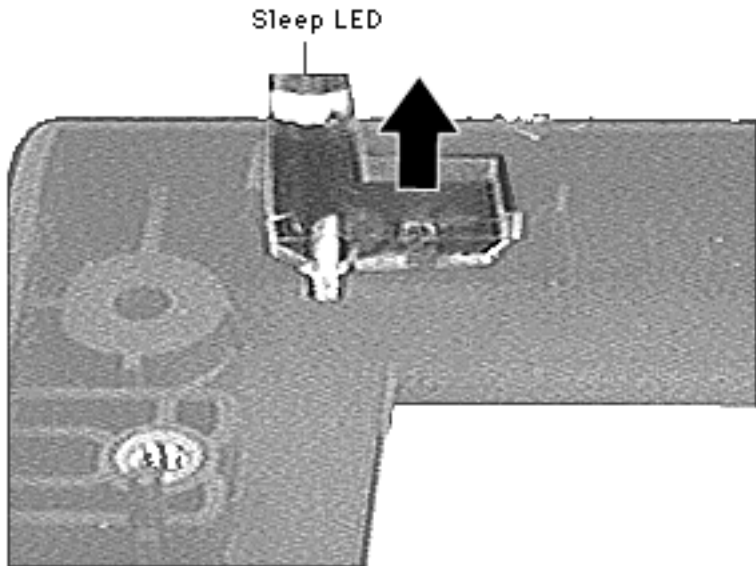

- Clutch

**Note:** Removal of the LED is only necessary if you are replacing it.

- 1 Remove the sleep LED.





## Additional Procedures

---

PowerBook 3400c/PowerBook G3





## Battery Verification

The Control Strip on the desktop indicates the battery charge and the rate at which the battery is being used.

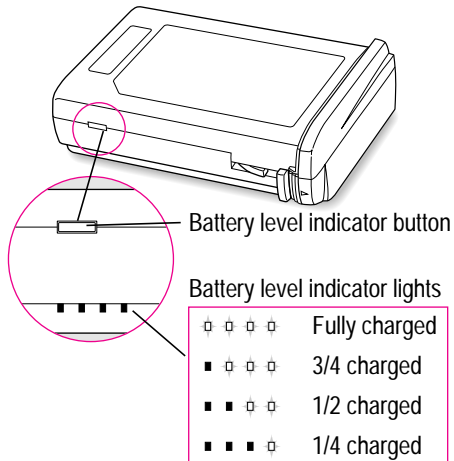

**Note:** The battery level indicator lights show whether the battery is fully-charged, three-fourths charged, one-half charged, or one-fourth charged.

- 1 To determine the actual battery charge, push in





the level indicator button to activate the indicator lights.

## Power Adapter Verification

No test is available for verifying the power adapter. Try using a new power adapter if the computer cannot run off the existing one.







## Backup Battery Verification

The backup battery saves the PRAM and power management information on the logic board when the computer is shut down. To check that the backup battery is working, follow the procedures below.

- 1 Set the date and time.
- 2 Perform a Shut Down from the Apple Menu or Special menu
- 3 Remove the main battery and disconnect the power adaptor for 10 minutes.
- 4 Connect the power adaptor, insert the battery, and power on the computer.
- 5 If the date and time were lost, the backup battery may be dead or discharged.





- 6 To recharge the backup battery, leave the PowerBook plugged in for 48 hours. It is ok to use it while it is charging.
- 7 If the backup battery appears dead or will not charge, replace the backup battery.





## PRAM and Power Manager Reset

**Caution:** Resetting parameter RAM (PRAM) erases the contents of the RAM disk, if there is one. Resetting PRAM also restores the default settings in most control panels. After you reset PRAM, be sure to check any custom settings for the desktop pattern, memory, network, AppleTalk, trackpad, power conservation, and so forth.

### Resetting PRAM

Reset/zap PRAM from the shutdown state. Note that resetting PRAM when the computer is shut down also resets the power manager.

Follow these steps to reset PRAM:

- 1 Unplug the AC adapter.





- 2 Power on the computer by pressing the Power key.
- 3 Immediately hold down the Option-Command-P-R keys.
- 4 Keep holding down these four keys until you have heard the startup chime at least one additional time after the initial startup chime.

(If the PowerBook emits multiple chimes when you are holding down the Option-Command-P-R keys, skip to Step 7.)

**Note:** Unlike other PowerBook models, these PowerBook computers often emit only a single startup chime. Then the screen goes dark/blank and the green sleep light stays on (it does not blink on and off as it does when the computer is in sleep mode).

- 5 Press the Reset button once and, after a brief pause, the PowerBook should start up.





**Note:** If the PowerBook powers off and the sleep display light stays a solid green with no blinking, press the Reset button again.

- 6 If the PowerBook does not power on from the Reset button, turn the PowerBook on by pressing the Power key.
- 7 After the computer has started up, select Shut Down from the Special menu.
- 8 Plug in the AC adapter. If the computer remains shut down, you will know that you have successfully reset the PRAM and power manager and your computer should now function normally. If, however, the computer powers on when you plug in the AC adapter, you need to reset the power manager.





## Resetting the Power Manager

Follow these steps to reset the power manager:

- 1 Remove the battery.
- 2 Disconnect the AC adapter from the PowerBook and unplug it from the wall outlet.
- 3 Press and hold the Reset button for one minute.
- 4 Plug the AC adapter into the wall outlet.
- 5 Connect the AC adapter to the PowerBook. It should now behave normally when you choose Shut Down from the Special menu.





## Battery Gasket Installation

The gasket kit comes with a set of foam gaskets and a wood applicator. Use the applicator to place a gasket on the inside of the battery bay.

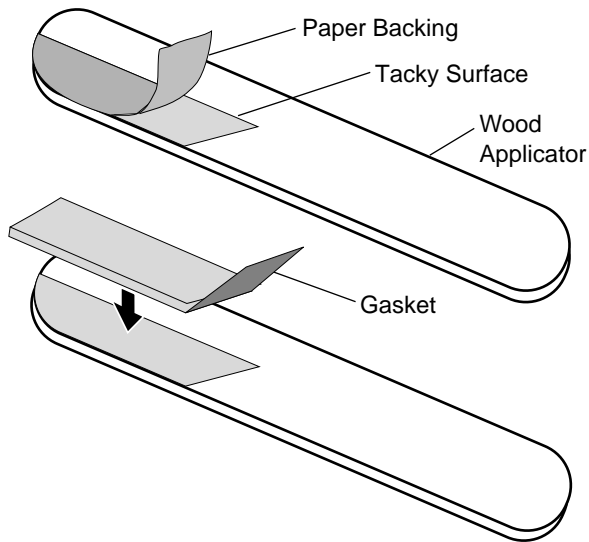

- 1 Remove the battery from the PowerBook 3400.
- 2 Remove the paper backing from the wood applicator and place the gasket adhesive-side up on the applicator's



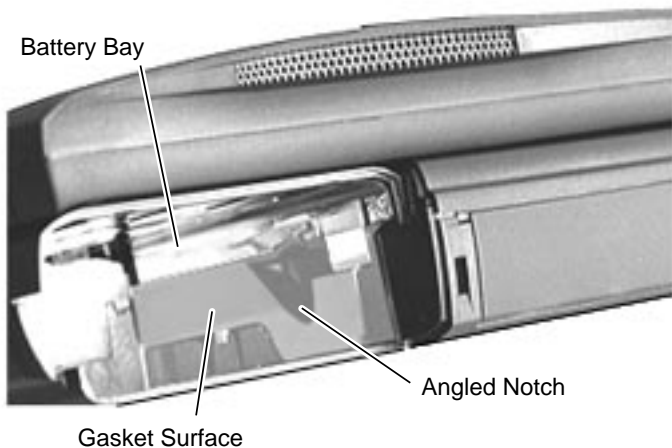
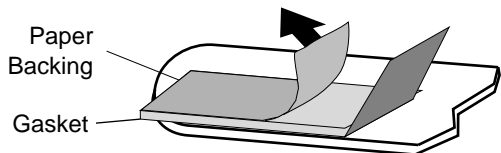

tacky surface.

- 3 Remove the backing from the adhesive side of the gasket.
- 4 Using the applicator, place the gasket on the notched side of the battery bay. Make sure the angled edge of the gasket aligns with the angled side of the notch and the gasket flap extends into the notched opening.

**Note:** Apply the gasket to the dull gray surface of the bay, not the shiny







metal surface above it.

- 5 Press the gasket onto the battery bay.

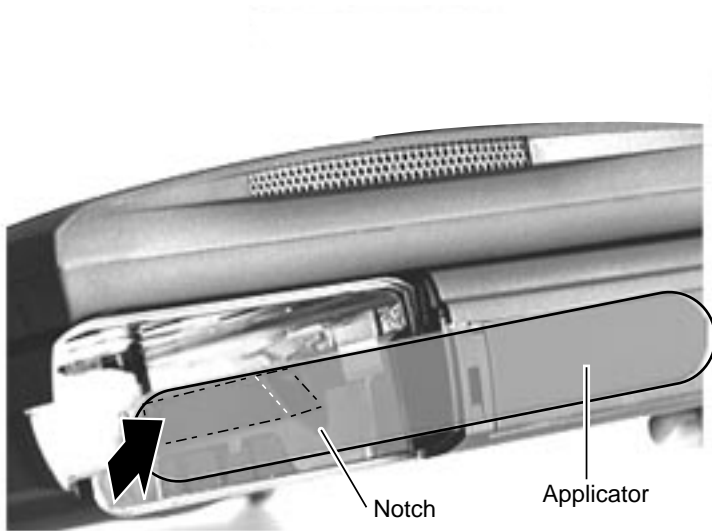

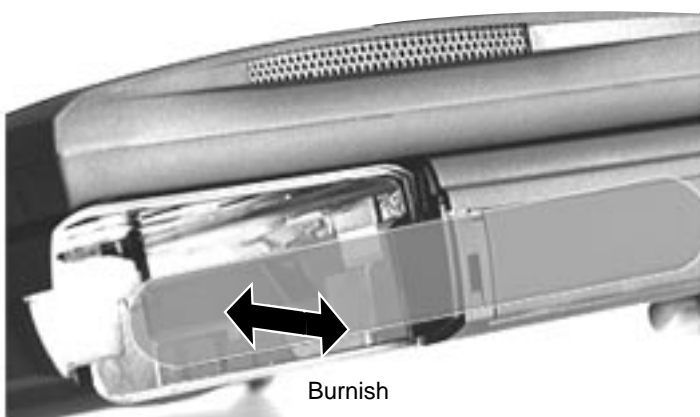

- 6 Remove the applicator from the bay and turn the applicator over so the non-sticky side faces the gasket.
- 7 Reinsert the applicator into the battery bay, and burnish the gasket to the bay.
- 8 Remove the applicator and replace the battery.





## Exploded View

---

PowerBook 3400c/PowerBook G3



