

eMac





Take Apart
eMac





Tools

The following tools are recommended for the take apart procedures.

- 2.5 mm hex (for rear housing)
- phillips #2 screwdriver
- jeweler's screwdriver set
- needlenose pliers
- ESD wriststrap and mat
- CRT discharge tool

Note: Do not use a power driver on the rear housing screws.



CRT Neck/Display/Analog Assembly Handling Information

Handling

Important: It is imperative that proper handling and packaging guidelines be followed when working with the display/analog assembly.

Do NOT lift, handle, bump, or manipulate the CRT neck/neck board (see red arrows below) on the Display/Analog assembly. Modules damaged by mishandling are NOT covered by Apple Warranty. Apple Authorized Service Providers can be liable for broken CRT necks due to improper handling.

Caution: The metal chassis has sharp edges, you may want to wear gloves when handling the assembly. Lift the assembly from the metal chassis; never lift the assembly from the neck. I



Packing a Defective Display/Analog Assembly

The packing procedure is included with the replacement display/analog assembly. Incorrect packaging can result in damaged eMac displays. Please read and follow the directions enclosed in the shipping box of the new display prior to packaging the defective assembly. AASPs can be liable for broken CRT necks due to improper packing and handling.



User Access Door

Tools

This procedure requires the following tools:

- Phillips #2 screwdriver

Part Location



Preliminary Steps

Before you begin, do the following:

- Place the computer face down on an ESD mat.

Procedure

1. Remove the screw on the user access door
2. Gently remove the access door.





Feet

Tools

This procedure requires the following tools:

- Phillips #2 screwdriver

Part Location



Preliminary Steps

Before you begin, do the following:

- Place the computer face down on an ESD mat.

Procedure

1. Remove the two screws. Set the plastic feet aside.





Rear Housing

Tools

- 2.5 mm hex.

Part Location



Preliminary Steps

Before you begin, do the following:

- Place the computer face down on an ESD mat.
- Remove the feet.

Procedure

1. Remove three screws located below the user access door (these three screws are longer than the rest of the rear housing screws).



2. Remove the six remaining rear housing screws.



-
3. Gently lift the rear housing up about 2 inches. **Warning:** If you lift the housing too fast, the power button (on the inside of the housing) can become permanently damaged or the machine may not power on.



4. Carefully disconnect the power cable from the power button located inside the rear housing. Lift the rear housing off the computer.





Power Button

Tools

- needlenose pliers
- **Note:** Follow this take-apart procedure only if you are replacing a defective power button.

Part Location



Preliminary Steps

Before you begin, do the following:

- Place the computer face down on an ESD mat.
- Remove the feet.
- Remove the rear housing.

Procedure

1. Disconnect the power cable from the power button located inside the rear housing. Lift the rear housing off the computer.



2. **Note:** Continue with this procedure only if you are replacing a defective power button. With a needlenose pliers, push the power button through the retaining ring. The power button will pop off rear housing and the retaining ring may get stuck on the pliers.

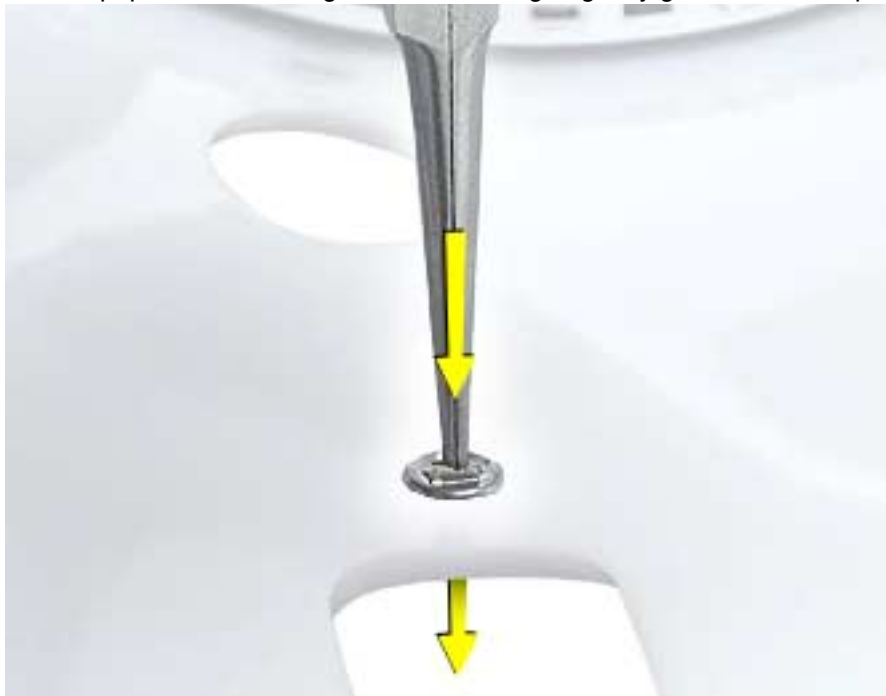

3. Save the retaining ring (shown below)



4. **Replacement Note:** Obtain a new power button and peel the sticky backing off the power button. Position the power button into the hole on the rear housing (as shown below). **Note:** The picture below is looking at the power button from the inside of the rear housing.

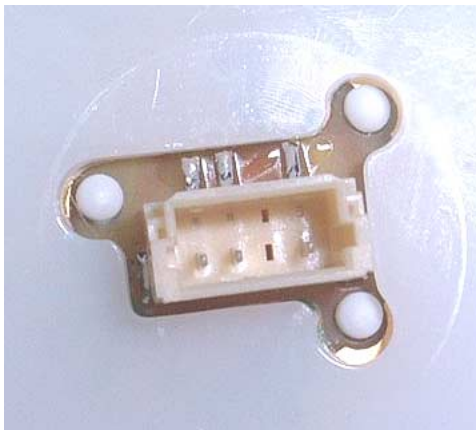

5. Place the retaining ring over the power button connector and press down firmly.



CRT Discharge

Warning: This product contains high voltage and a high-vacuum picture tube. To prevent injury, always review the Service Foundations: CRT Displays course for safety information. It can be found at: http://service.info.apple.com/service_training/training.html. Click on Desktop Certification Courses and select the Service Foundations: CRT Displays link.

Warning: Never use a grounding wriststrap until after discharging the CRT and setting up an ongoing ground connection.

Safety Guidelines:

Whenever the rear housing of the computer is removed and before replacing a module, you must

1. Discharge the CRT (shown below) and remove the anode cap.



2. Establish an ongoing ground by using a cable with alligator clips at both ends. Connect one end to the anode aperture, and connect the other end to the metal CRT frame (as shown below).
3. With the CRT discharged and the ongoing ground in place wear a grounding wriststrap to prevent equipment damage from static electricity.



Speakers

Tools

This procedure requires the following tools:

- Jeweler's #1 screwdriver (for removing metal plate on speaker assembly)

Part Location



Preliminary Steps

Before you begin, do the following:

- Place the computer face down on an ESD mat.
- Remove the user access door.
- Remove the feet.
- Remove the rear housing.
- Discharge the CRT.

Procedure

1. **Note:** The speaker assembly is not screwed down. Gently pull the speaker assembly in the direction of the arrow.

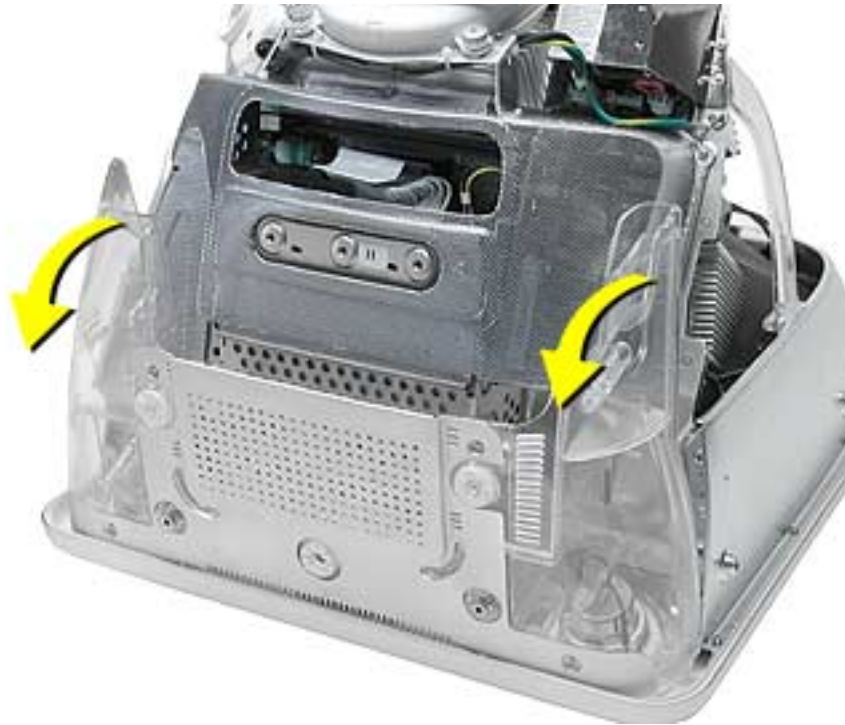

2. Disconnect the speaker cable on the left side. Lift the speaker assembly out of the computer.





Fan

Tools

This procedure requires the following tools:

- Phillips #2

Part Location



Preliminary Steps

Before you begin, do the following:

- Place the computer face down on an ESD mat.
- Remove the user access door.
- Remove the feet.
- Remove the rear housing.
- Discharge the CRT.

Procedure

1. With the fan facing you, disconnect the two circled screws and disconnect the fan cable.

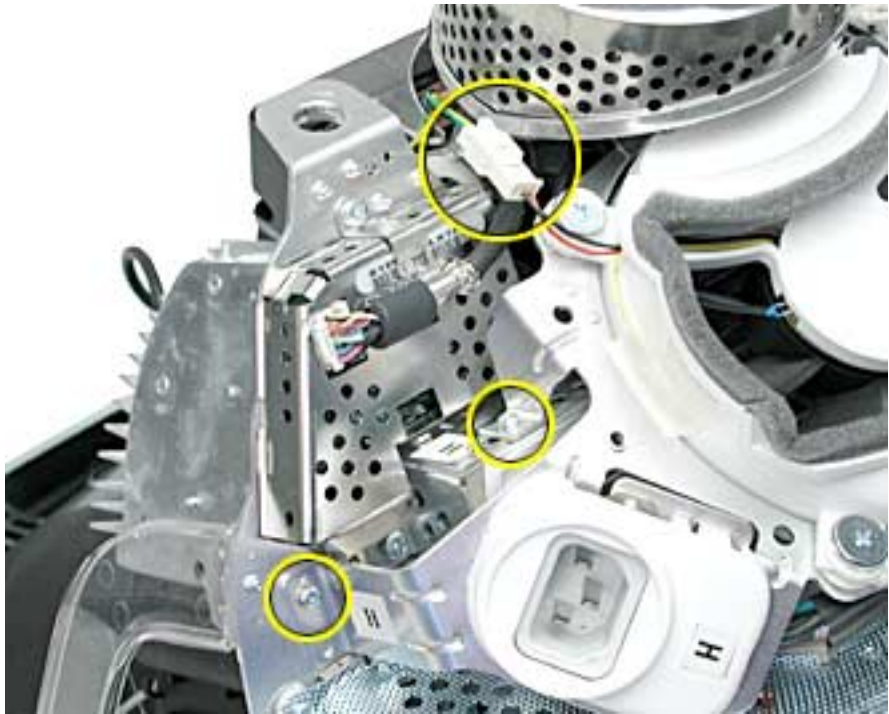

2. On the right side of the fan, remove two screws (one of which is the ground screw), and disconnect the fan power cable.

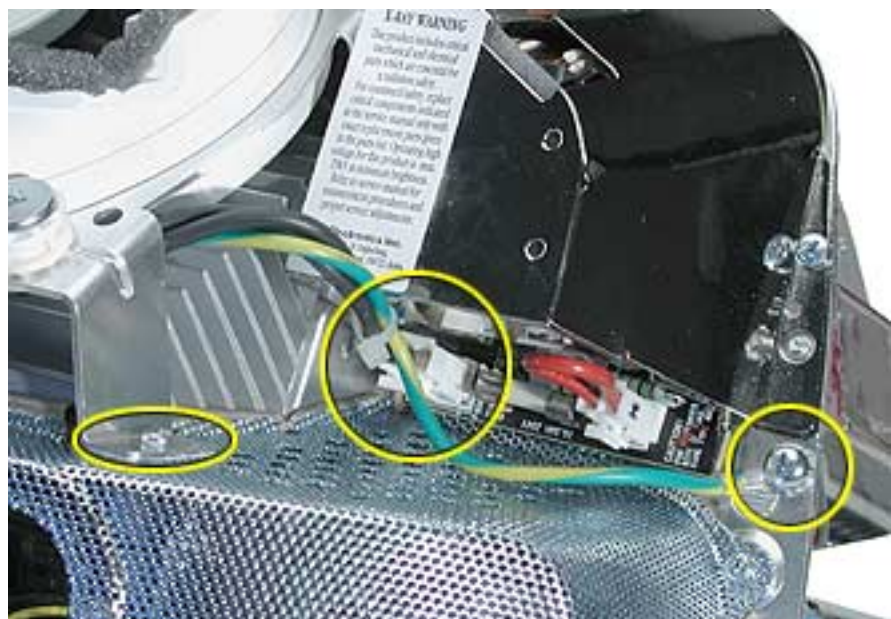

3. To locate the last fan screw, turn the computer so the anode socket is facing you. You'll see two screws. Remove the top screw.



4. To remove the fan, turn the computer so the fan is facing you. Grab onto the fan near the AC plug and the bottom right corner of the fan. Gently pull the fan toward you and away from the chassis. Be very careful of the CRT neck.



Faraday Cage

Tools

This procedure requires the following tools:

- Phillips #2

Part Location



Preliminary Steps

- Place the computer face down on an ESD mat.
- Remove the user access door.
- Remove the feet.
- Remove the rear housing.
- Discharge the CRT.
- Remove the fan.

Procedure

1. Remove the five screws. **Important:** Push the power button cable inside the Faraday cage so it doesn't get caught when you remove the Faraday cage.

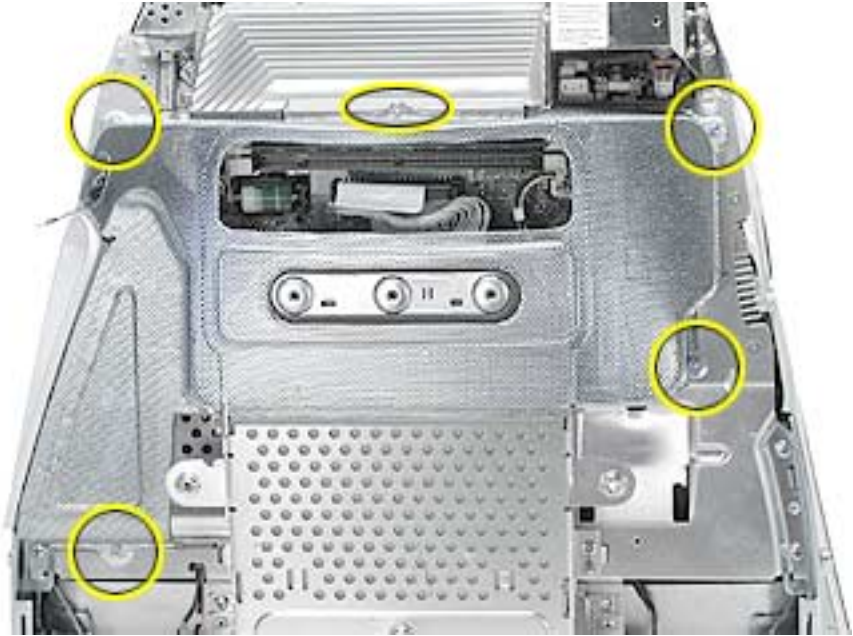

2. Gently pry the Faraday cage away from the chassis in the direction of the arrows.

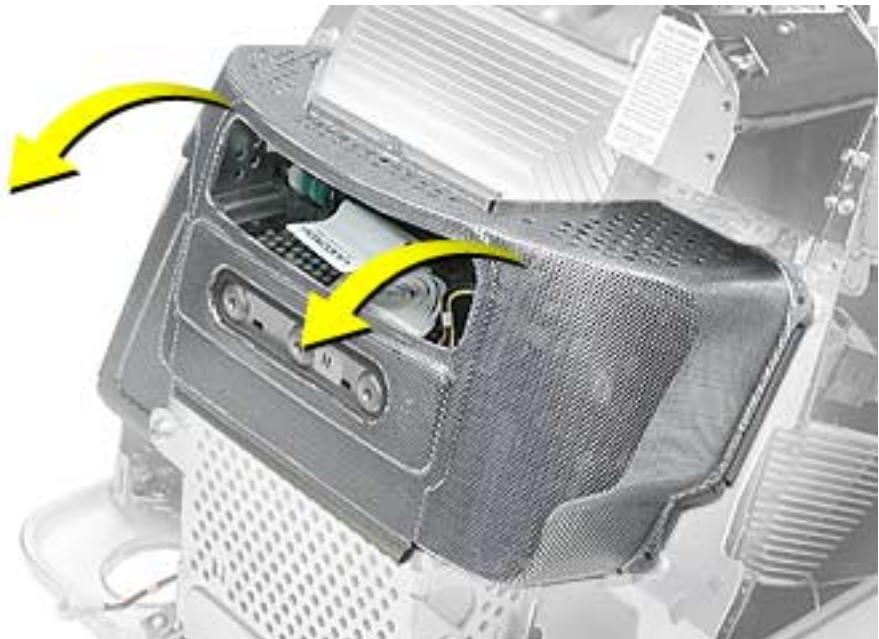



Digital Module Assembly

Tools

This procedure requires the following tools:

- Phillips #2

Part Location



Preliminary Steps

Before you begin, do the following:

- Place the computer face down on an ESD mat.
- Remove the user access door.
- Remove the feet.
- Remove the rear housing.
- Discharge the CRT.

-
- Remove the fan.
 - Remove the Faraday cage.
 - Remove the AirPort Card if installed.

Procedure

1. With the digital module facing you, remove the four screws on the left side of the digital module.



2. Next, remove the three screws on the right side.

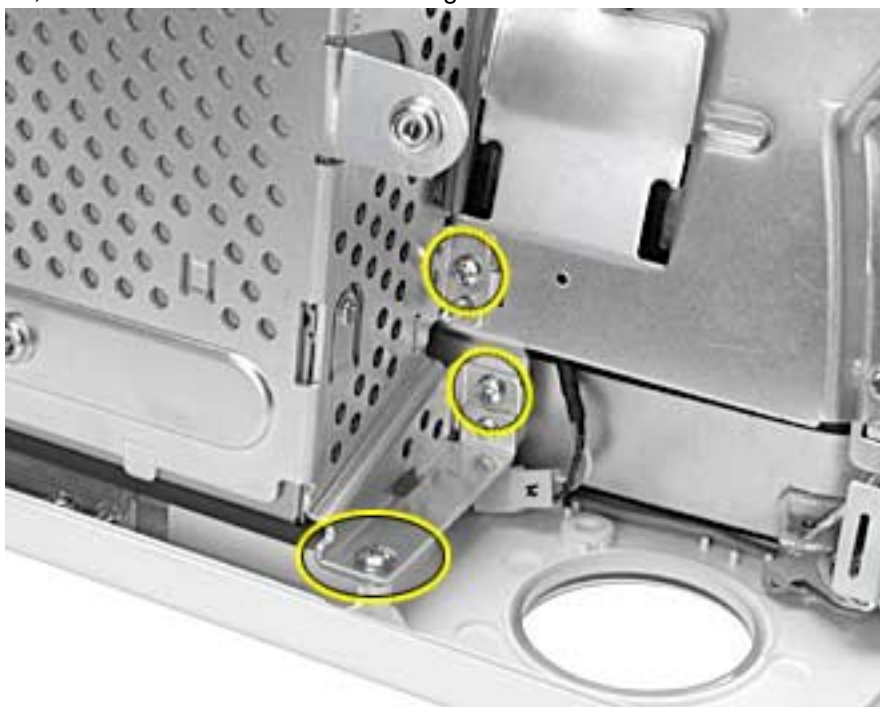

3. On the top right side of the digital module, remove one screw.



4. On the top left side of the digital module, remove one screw.

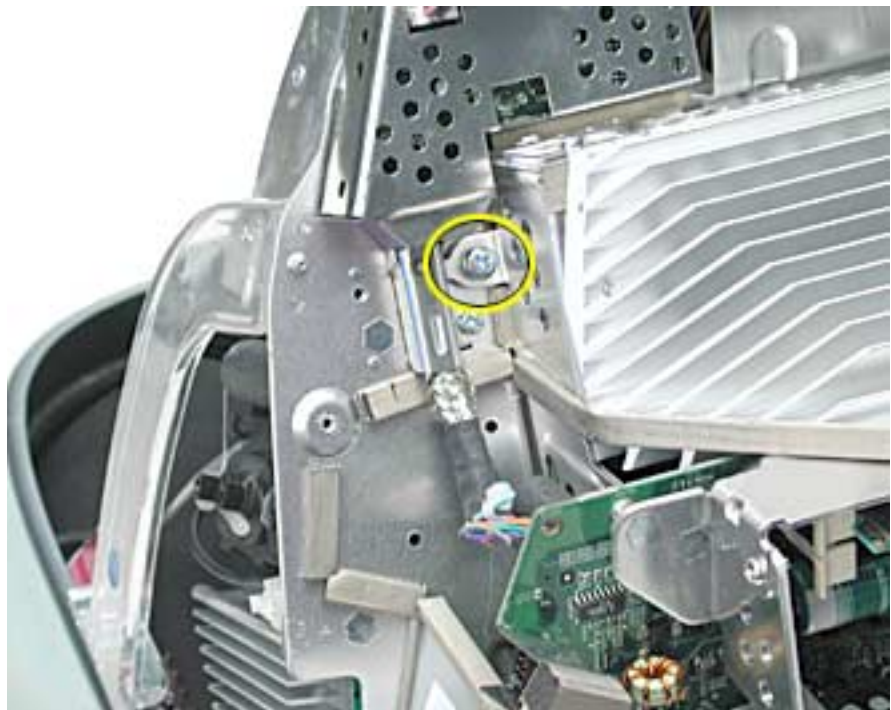

5. Remove one screw on the I/O panel and disconnect the video cable located above the screw. Squeeze the tabs to disconnect the video cable.



6. **Note:** Remove the AirPort card if it's installed. Grab onto the digital module at the tabs circled below. Pull in the direction of arrow. The digital module is connected to blind-mate connectors. It's a tight fit, so pull hard.

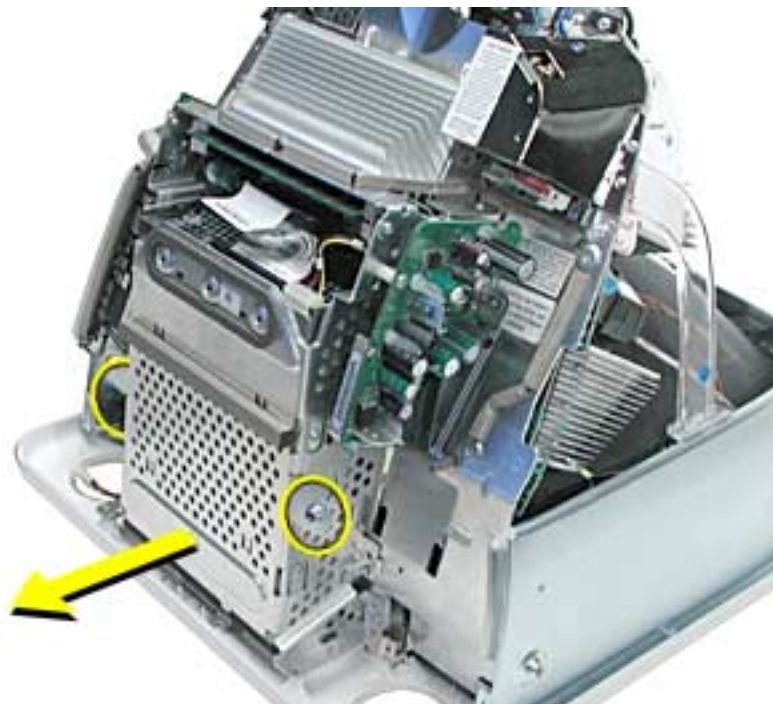



IVAD Cable

Important: Take Apart Note: Replace the IVAD cable if the eMac raster shifts upward from the bottom of the display or the raster is jumpy, otherwise leave the cable alone. Refer to Knowledge Base article 95168 for more information.

Tools

This procedure requires the following tools:

- 2.5 mm hex tool
- Phillips #2 screwdriver
- Hot-melt glue gun (recommended)
- Nylon probe tool (922-5065)

Procedure

1. Remove the rear housing from the eMac.
2. Discharge the CRT. **Warning:** This product contains high voltage and a high-vacuum picture tube. To prevent injury, review the Service Foundations course: “CRT Displays” for safety information.
3. Locate the IVAD assembly shown below.

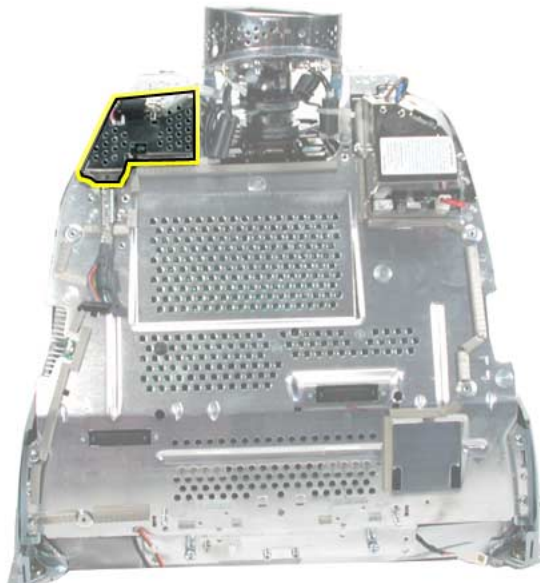

4. **Note:** The screws on IVAD assembly need to be removed to access one end of the IVAD cable. Remove the screw (circled below) and then remove the metal cable cover.

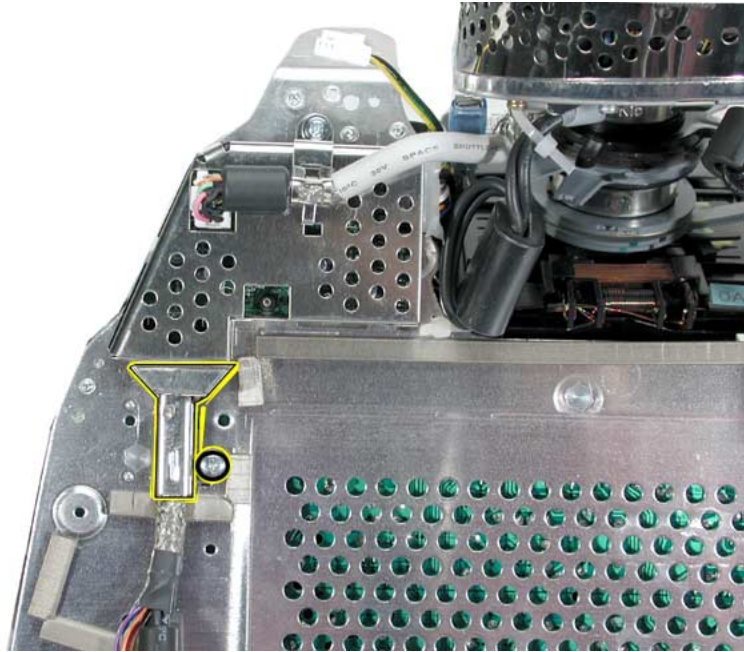

5. Remove the remaining two screws on the IVAD assembly.

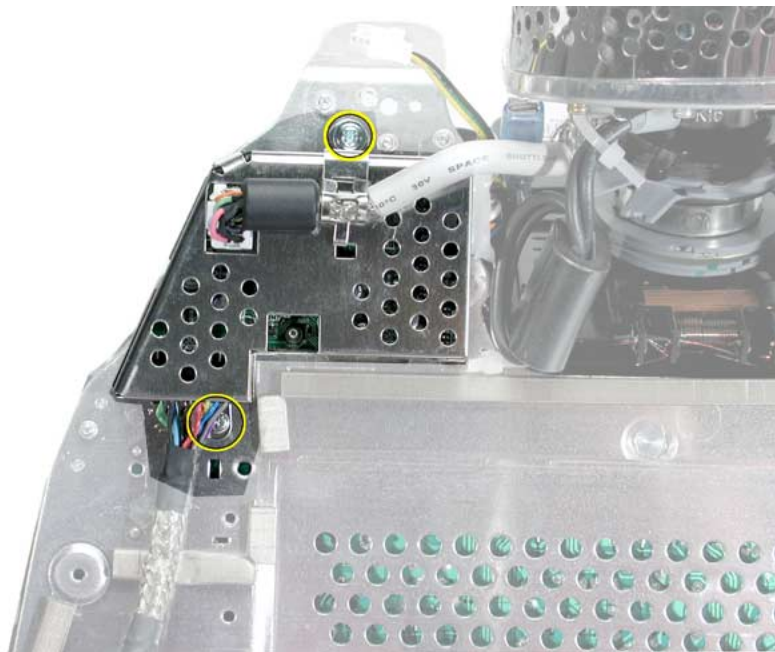

6. With the nylon probe tool or needlenose pliers, remove the glue from the connector. **Note:** If you find it difficult removing the glue use a heat gun to soften the glue a bit and then remove it. Disconnect the cable after removing the glue.

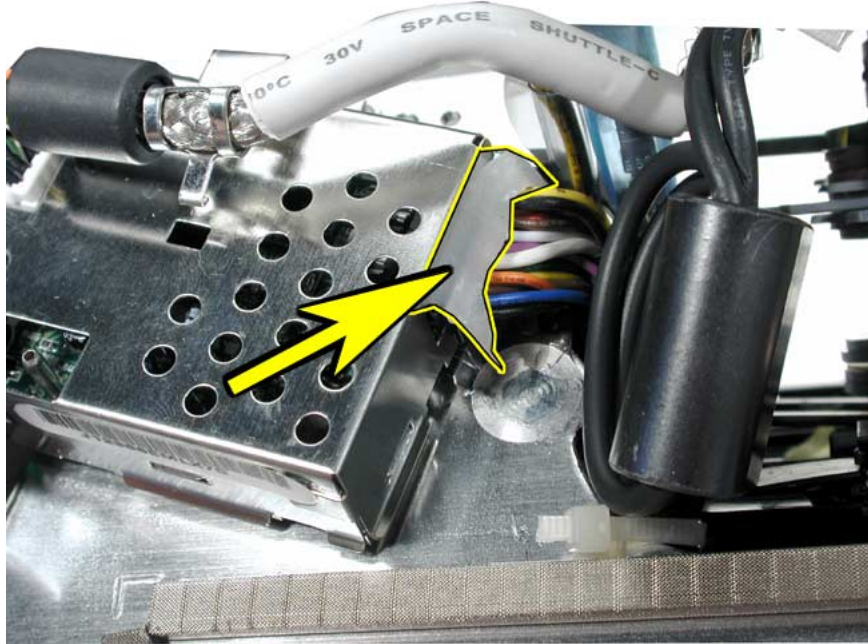

7. Locate the other end of the IVAD cable.

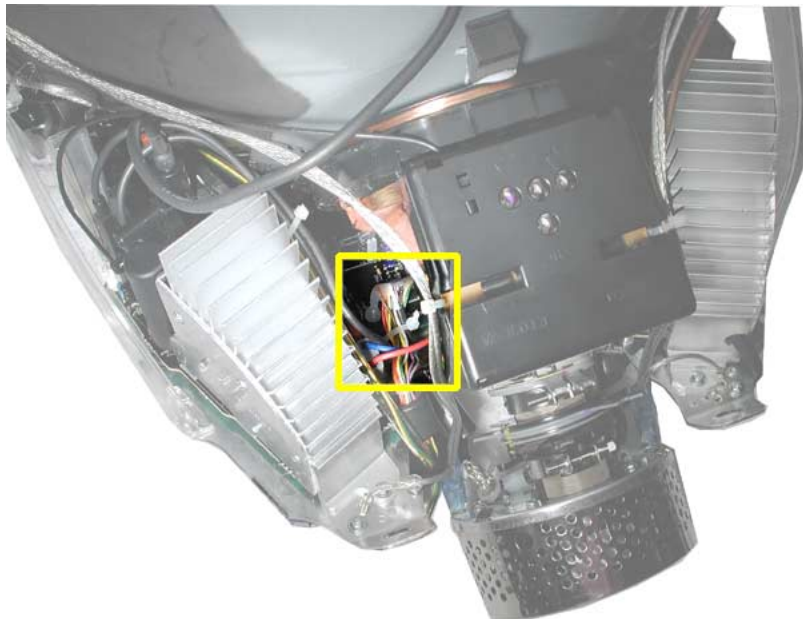

8. With the nylon probe tool or needlenose pliers, remove the glue from the cable connector. **Note:** If you find it difficult removing the glue use a heat gun to soften the glue a bit and then remove it.

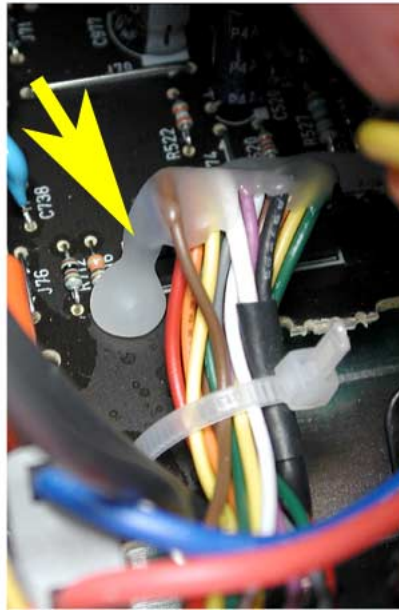

9. Clip the cable tie. Disconnect the IVAD cable from the board.

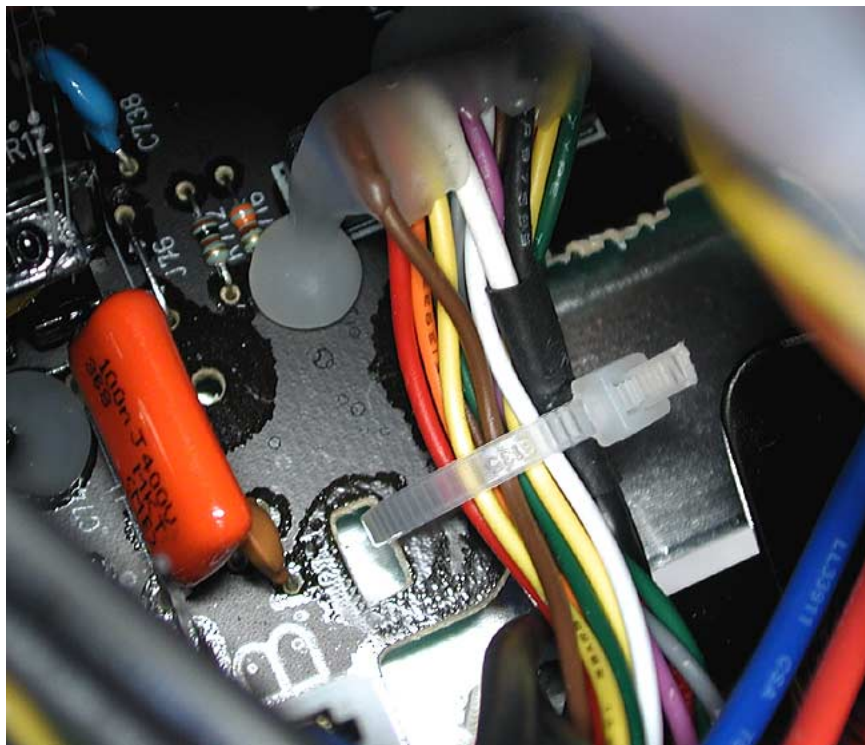

IVAD Cable Replacement Procedure

1. Install the replacement IVAD cable.
2. Replace the cable tie (shown on the previous page).
3. Place hot glue on each end of the IVAD connector.
4. Reassemble the computer and test the system.



AirPort Card Guide

Tools

This procedure requires the following tools:

- Phillips #2

Part Location



Preliminary Steps

Before you begin, do the following:

- Place the computer face down on an ESD mat.
- Remove the user access door.
- Remove the feet.
- Remove the rear housing.

- Discharge the CRT.
- Remove the fan.
- Remove the Faraday cage.
- Remove the digital module assembly.

Procedure

1. Remove the two screws connecting the guide to the chassis.

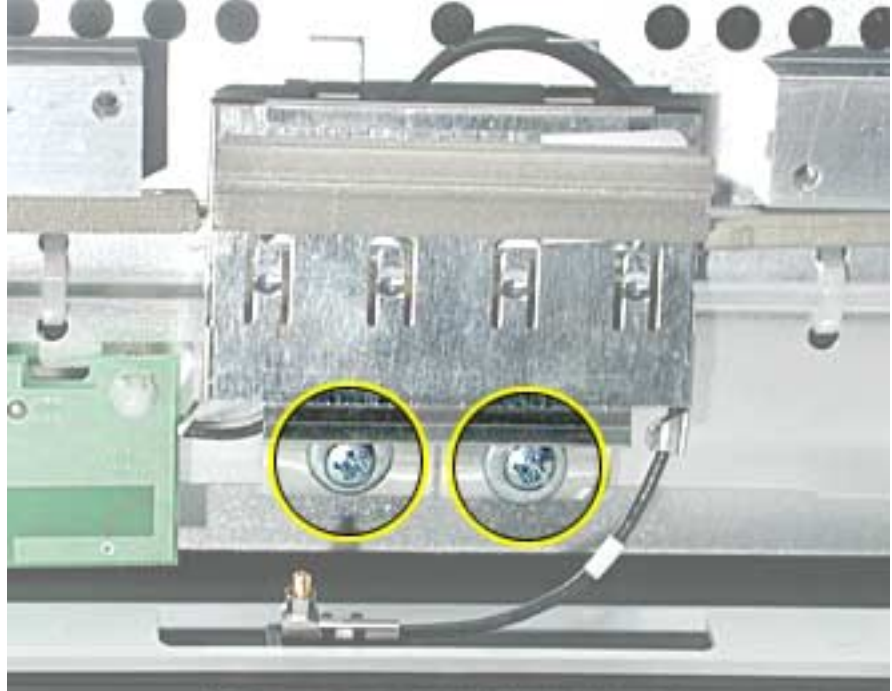

2. Lift the AirPort card guide in the direction of the arrow to unhook the metal tabs (circled) on the chassis. Disconnect the antenna from the AirPort card guide **Note:** Tape the antenna to the bottom of the unit while in for service.

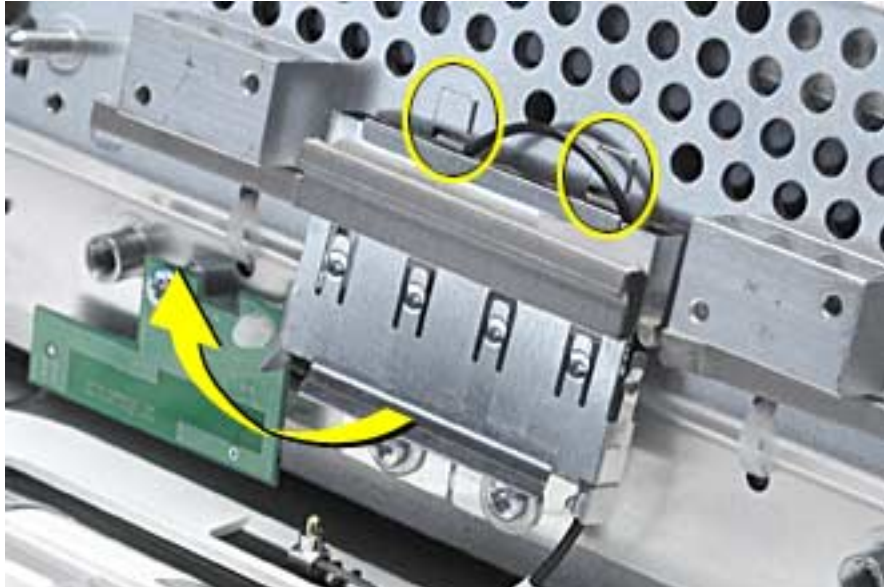



LED

Tools

This procedure requires the following tools:

- Phillips #2

Part Location



Preliminary Steps

Before you begin, do the following:

- Place the computer face down on an ESD mat.
- Remove the user access door.
- Remove the feet.
- Remove the rear housing.
- Discharge the CRT.

- Remove the fan.
- Remove the Faraday cage.
- Remove the digital module assembly.

Procedure

1. Remove one screw and disconnect the LED cable. **Important:** The connector is very fragile, remove it gently. Lift the LED board off the LED reflector.



2. **Note:** The LED consists of two parts; the LED board and the LED reflector (black plastic piece shown below). Remove the LED reflector from the bezel.





Front Bezel

Tools

This procedure requires the following tools:

- Phillips #2

Part Location



Preliminary Steps

Before you begin, do the following:

- Place the computer face down on an ESD mat.
- Remove the user access door.
- Remove the feet.
- Remove the rear housing.
- Discharge the CRT.
- Remove the fan.

-
- Remove the Faraday cage.
 - Remove the digital module assembly.

Procedure

1. Remove the eight bezel screws. There are three on each side and two at the top of the bezel.

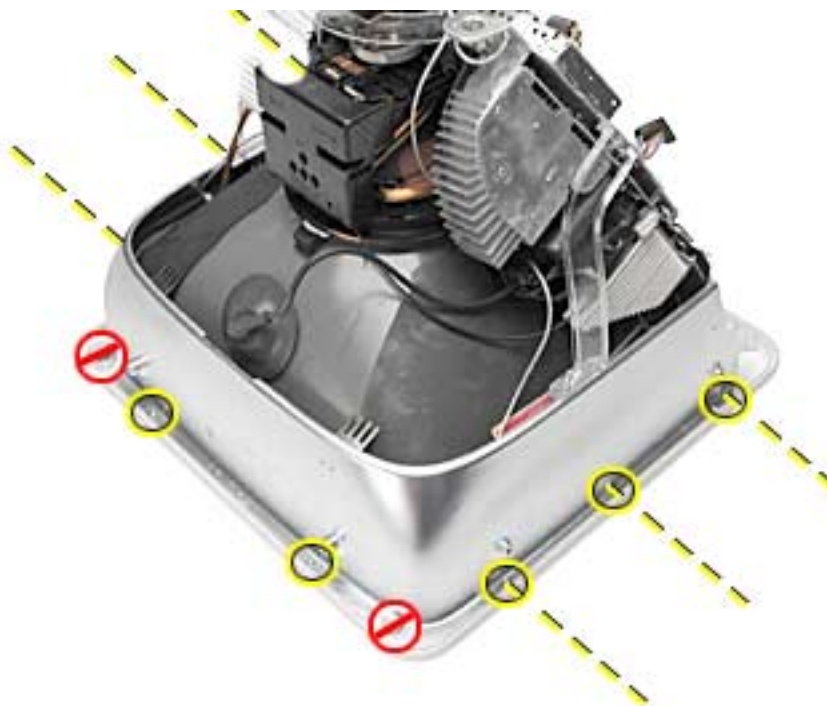

2. **Important:** DO NOT remove the two larger screws shown below, or the two screws shown in the next photo. **DO NOT** remove these larger screws. If they are removed, the CRT will be out of alignment and the entire display/analog assembly will need to be replaced.



3. Do Not remove these CRT screws either.



4. Disconnect the microphone cable.



5. **Carefully** lift the display/analog assembly off the bezel.



Antenna Board

Tools

This procedure requires the following tools:

- Phillips #2 screwdriver
- Needlenose pliers

Part Location



Preliminary Steps

Before you begin, do the following:

- Place the computer face down on an ESD mat.
- Remove the user access door.
- Remove the feet.
- Remove the rear housing.
- Discharge the CRT.
- Remove the fan.
- Remove the Faraday cage.

- Remove the front bezel.
- Remove the digital module assembly.

Procedure

1. Remove one screw and pinch the standoff with a needlenose pliers to release the antenna board from the divider panel.

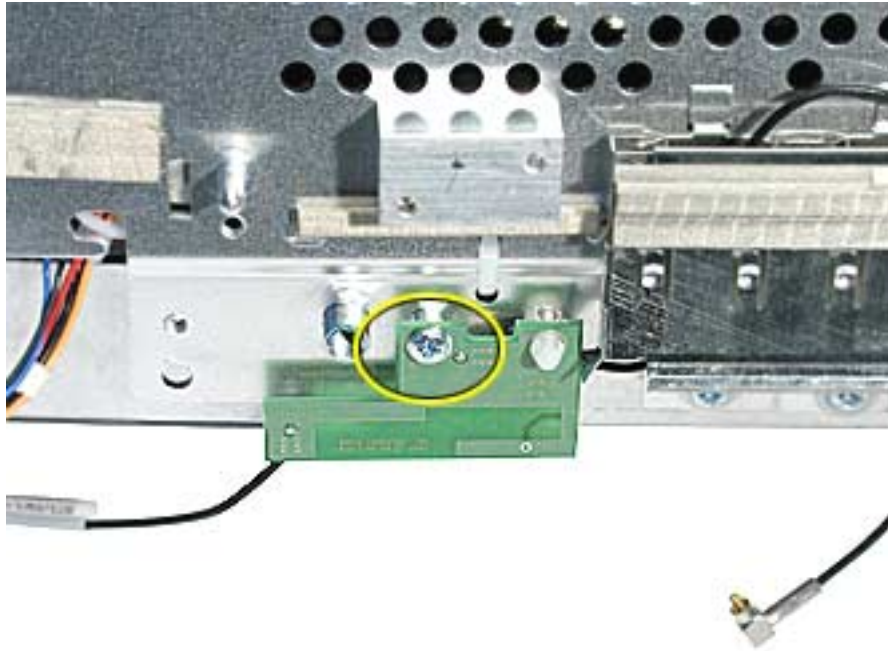

- Carefully position the computer on its base. Facing the CRT, locate the metal antenna bracket at the top of the CRT. Remove the screw attached to the bracket.



- Carefully pry the antenna cable from the two clips on the side of the CRT.





Microphone

Tools

This procedure requires the following tools:

- Phillips #2

Part Location



Preliminary Steps

Before you begin, do the following:

- Place the computer face down on an ESD mat.
- Remove the user access door.
- Remove the feet.
- Remove the rear housing.
- Discharge the CRT.
- Remove the fan.

-
- Remove the Faraday cage.
 - Remove the digital module assembly.
 - Remove the front bezel.

Procedure

1. Remove the microphone cable from the bezel. **Replacement Note:** When replacing the microphone into the bezel, the metal faces down, the dimple faces up.





Down Converter

Tools

This procedure requires the following tools:

- Phillips #2

Part Location



Preliminary Steps

Before you begin, do the following:

- Place the computer face down on an ESD mat.
- Remove the user access door.
- Remove the feet.
- Remove the rear housing.
- Discharge the CRT.
- Remove the fan.
- Remove the Faraday cage.

Procedure

1. With the down converter still attached to the digital module, remove the screw shown below.



2. Looking at the digital module from the back, remove the second screw.

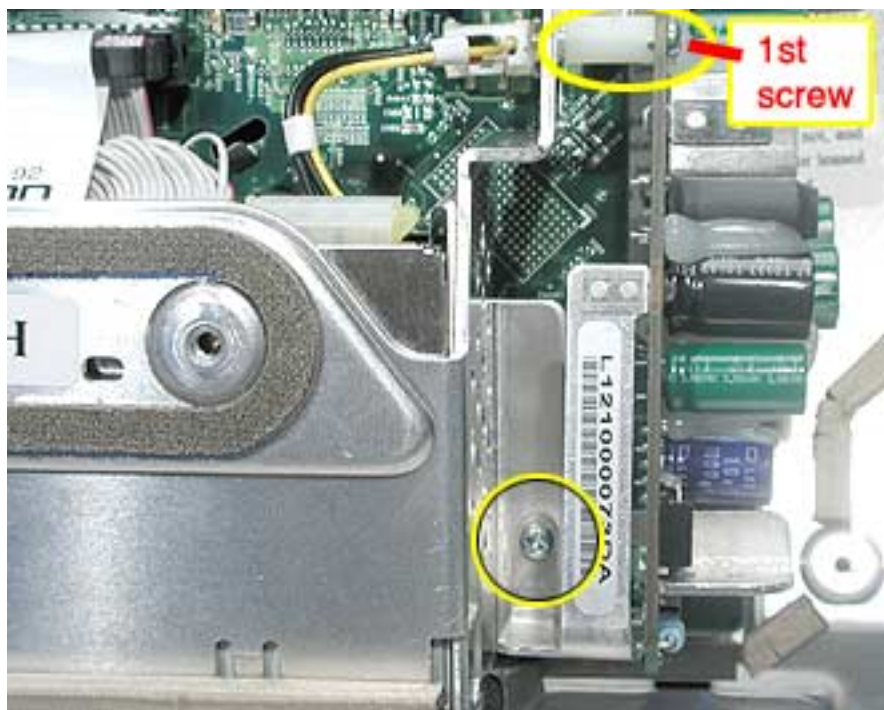

3. Disconnect the down converter from the logic board by holding the board at the top and the bottom and gently rock the board in the direction of the arrow.

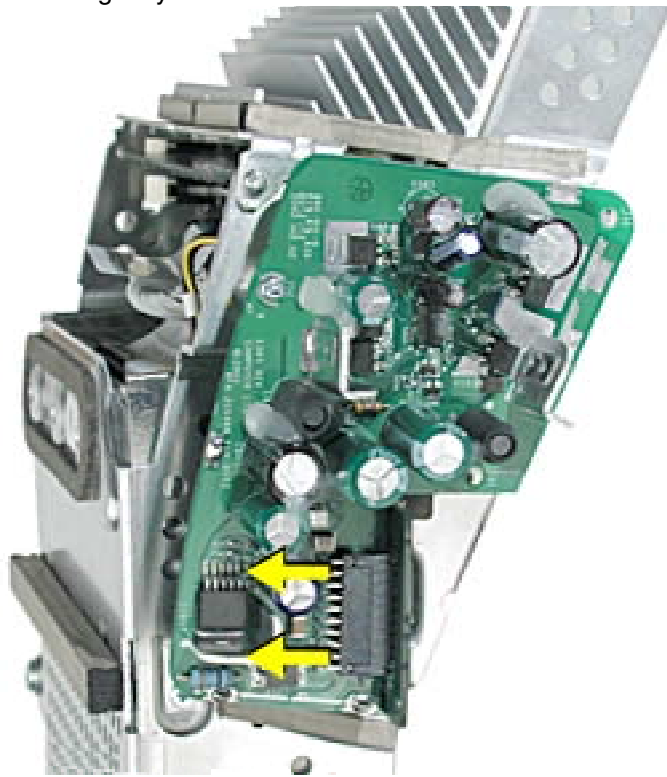



Door Assembly

Tools

This procedure requires the following tools:

- Phillips #2

Part Location



Preliminary Steps

Before you begin, do the following:

- Place the computer face down on an ESD mat.
- Remove the user access door.
- Remove the feet.
- Remove the rear housing.
- Discharge the CRT.
- Remove the fan.

- Remove the Faraday cage.
- Remove the digital module assembly.

Procedure

1. Remove the two screws connecting the door to the front bezel.



2. Remove the door from the front bezel. **Replacement Note:** Transfer the serial number label on the inside of the door to the replacement door.



Hard Drive

Tools

This procedure requires the following tools:

- Phillips #2
- Jeweler's #1 screwdriver

Part Location



Preliminary Steps

Before you begin, do the following:

- Place the computer face down on an ESD mat.
- Remove the user access door.
- Remove the feet.
- Remove the rear housing.
- Discharge the CRT.

- Remove the fan.
- Remove the Faraday cage.
- Remove the digital module assembly.

Procedure

1. Remove the three screws along the back of the hard drive.

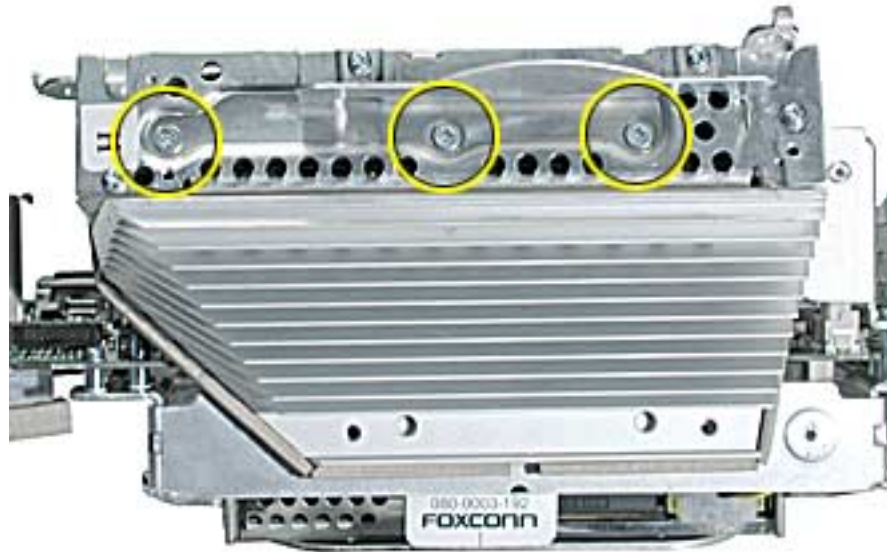

2. With a screwdriver or plastic tool, pry the hard drive out of the hard drive carrier to access the power and data cables.



3. Disconnect the hard drive power cable and the hard drive data cable. Remove the drive from the carrier. Notice the three thermal pads on the hard drive; two on the top and one along the side of the drive. Replace the thermal pads if they are damaged.



-
4. Turn the hard drive over. With a jeweler's screwdriver, remove the two screws on the black plastic cover and the two screws on the metal bracket. **Note:** These two pieces need to be removed when returning the hard drive to Apple service.





Hard Drive Carrier

Tools

This procedure requires the following tools:

- Phillips #2 screwdriver

Part Location



Preliminary Steps

Before you begin, do the following:

- Place the computer face down on an ESD mat.
- Remove the user access door.
- Remove the feet.
- Remove the rear housing.
- Discharge the CRT.
- Remove the fan.

- Remove the Faraday cage.
- Remove the digital module assembly.
- Remove the hard drive.

Procedure

1. Remove the seven carrier screws. Peel back the EMI tape on the on both sides of the carrier.

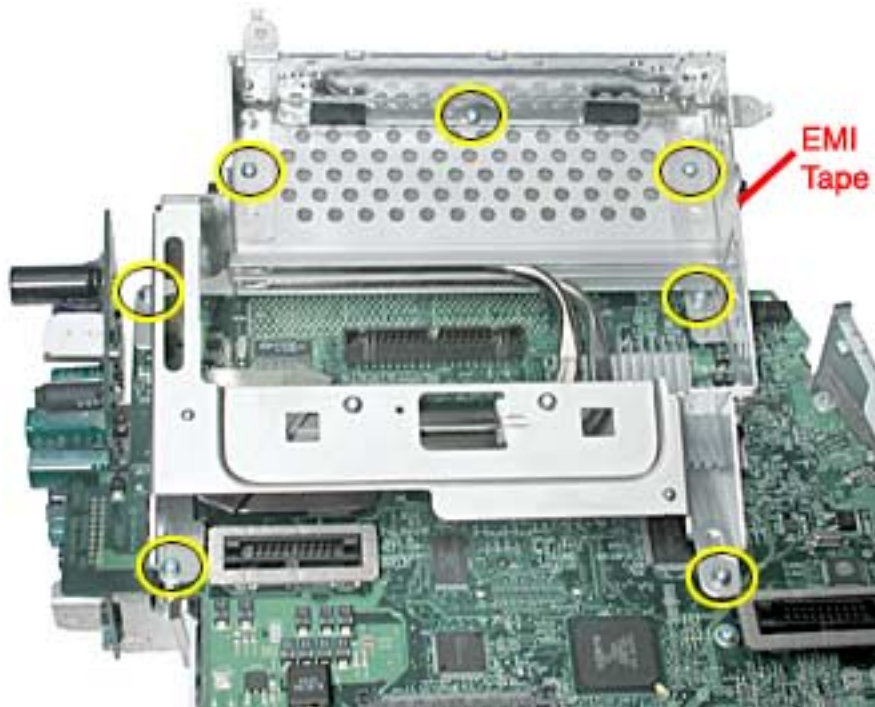

2. Lift the carrier off the logic board.



Logic Board Heatsink

Tools

This procedure requires the following tools:

- Screwdriver to pry the heatsink clip

Part Location



Preliminary Steps

Before you begin, do the following:

- Place the computer face down on an ESD mat.
- Remove the user access door.
- Remove the feet.
- Remove the rear housing.
- Discharge the CRT.
- Remove the fan.
- Remove the Faraday cage.
- Remove the digital module assembly.

- Remove the hard drive.
- Remove the hard drive carrier.

Procedure

1. With a screwdriver, pry the heatsink clip out of the hole on the logic board.

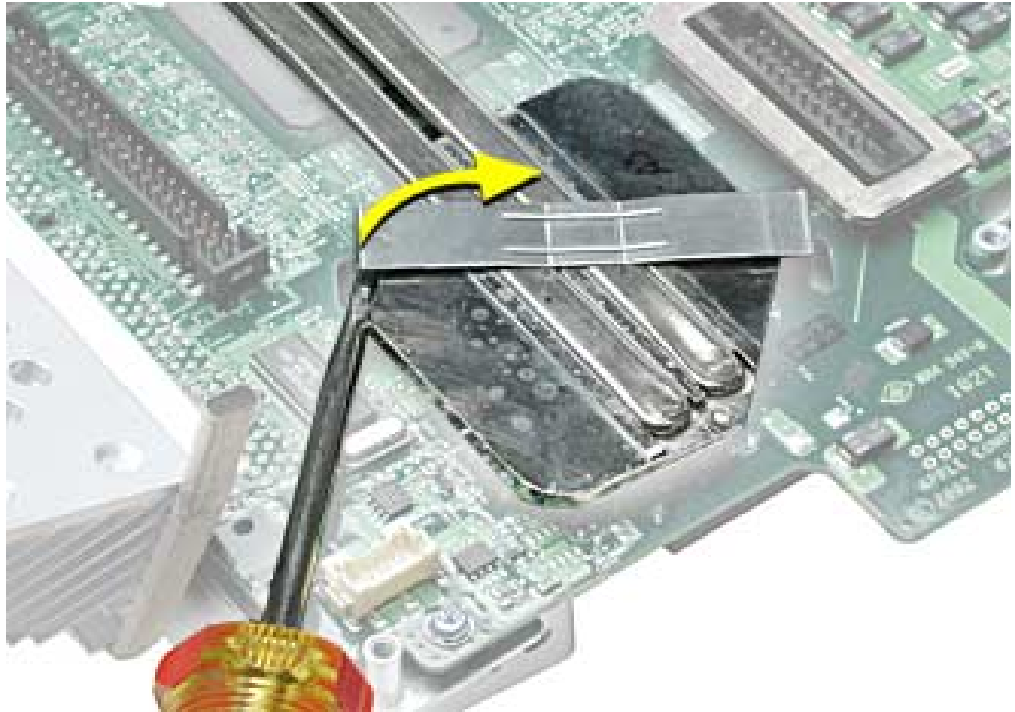

2. Lift the heatsink off the logic board. **Replacement Note:** Whenever the heatsink is removed, the bottom side of the heatsink and the top of the microprocessor must be cleaned and thermal paste must be applied to the microprocessor. If the mating surfaces are not cleaned and thermal paste is not applied, the CPU may overheat and become damaged. Refer to the next topic, “Thermal Paste Application”.

Thermal Paste Application

The microprocessor uses a heatsink/thermal pipe to transfer heat away. Whenever the heatsink is removed, the bottom side of the heatsink and the top of the microprocessor must be cleaned and thermal paste must be applied. If the mating surfaces are not cleaned and thermal paste is not applied, the CPU may overheat and become damaged.

Tools

This procedure requires the following tools:

- Plastic stylus or nylon probe tool (922-5065) to remove the old thermal paste
- Thermal paste (922-4757), each tube contains 4-5 applications

Procedure

1. Thoroughly clean the thermal film from the heatsink surface with a plastic stylus or the nylon probe tool. Do not use an abrasive material or liquid cleaner. **Important:** Be extremely careful not to bend the heatpipes on the heatsink.



- Carefully clean the surface of the microprocessor with a plastic stylus or nylon probe tool (922-5065) to remove the old thermal paste.



- Squeeze a drop of thermal paste onto the middle of the microprocessor as shown.



4. Spread the paste evenly over the processor. **Important:** On this product, it is critical to spread the paste over the processor, or the chip could overheat.



5. Reinstall the heatsink and heatsink clip.





Logic Board

Tools

This procedure requires the following tools:

- Phillips #2 screwdriver

Part Location



Preliminary Steps

Before you begin, do the following:

- Place the computer face down on an ESD mat.
- Remove the user access door.
- Remove the feet.
- Remove the rear housing.
- Discharge the CRT.
- Remove the fan.
- Remove the Faraday cage.

- Remove the digital module assembly.
- Remove the hard drive.
- Remove the down converter.
- Remove the hard drive carrier.
- Remove the logic board heatsink.

Procedure

1. Carefully position the assembly on the optical drive door. Disconnect the optical data cable and the optical power cable.

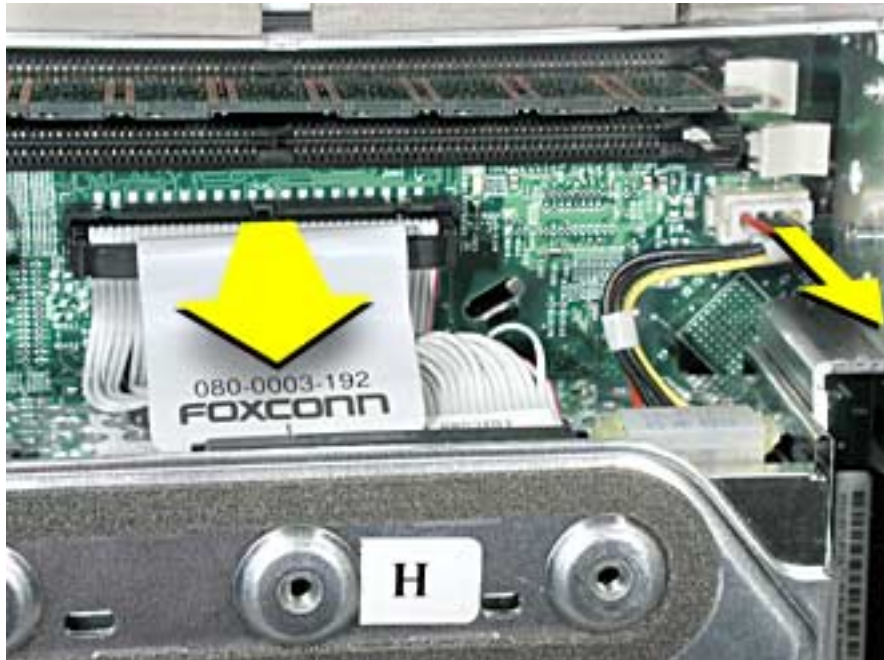

2. Turn the assembly so the logic board is facing up. Remove the four screws on the logic board. **Note:** The screw in the bottom left corner is different from the other three screws. It is self-tapping with no collar.

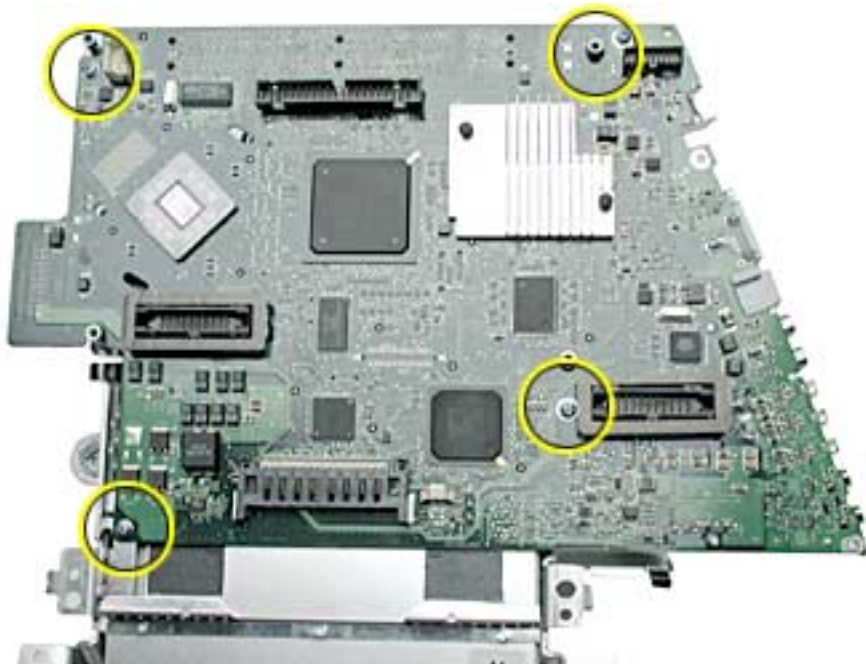

3. Lift the logic board off the optical assembly. Before returning the board to Apple, remove the following items:
 - I/O panel
 - RJ-11 connector (if present)
 - Modem board
 - SDRAM
 - **Warning:** The microprocessor uses a heatsink/thermal pipe to transfer heat away. Whenever the heatsink is removed, the bottom side of the heatsink and the top of the microprocessor must be cleaned and thermal paste must be applied to the microprocessor. If the mating surfaces are not cleaned and thermal paste is not applied, the CPU may overheat and become damaged. Refer to “Thermal Paste Application” in this chapter.



Memory

Tools

- No tools are required for this procedure

Part Location

Note: Memory can be accessed through the user access door on the back of the computer.



Preliminary Steps

Before you begin, do the following:

- Place the computer face down on an ESD mat.
- Unplug all cables except the power cord, from the computer.
- Remove the user access door.

Procedure

1. Touch a metal surface inside the computer. Then unplug the computer. **Important:** Always do this before you touch any parts, or remove/install any components inside the computer. To avoid generating static electricity, do not walk around until you have finished removing or installing the memory and closed the computer.



2. Locate the memory module.



3. Push the ejectors on the memory slot outward and down (#1) so they are in the open position. Remove the memory module (#2). **Replacement Note:** The memory is designed to fit into the slot only one way. Be sure to align the notches on the module with the small notches inside the slot.

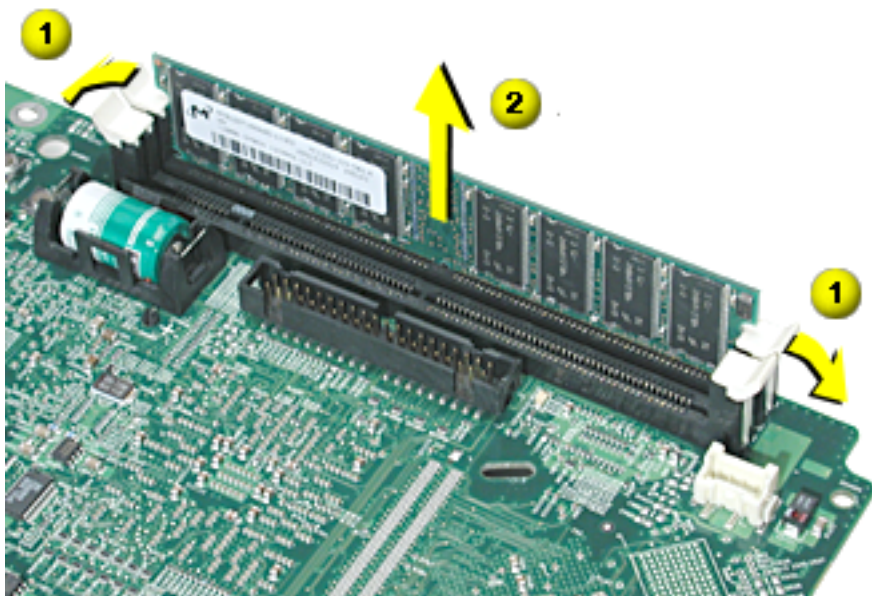



Battery

Tools

- No tools are required for this procedure

Part Location

Note: The battery can be accessed through the user access door on the back of the computer.



Preliminary Steps

Before you begin, do the following:

- Place the computer face down on an ESD mat.
- Unplug all cables except the power cord, from the computer.
- Remove the user access door.

Procedure

1. Touch a metal surface inside the computer. Then unplug the computer. **Important:** Always do this before you touch any parts, or remove/install any components inside the computer. To avoid generating static electricity, do not walk around until you have finished removing or installing the battery and closed the computer.



2. With a screwdriver or anti-static tool, carefully pry the battery out of the battery holder.

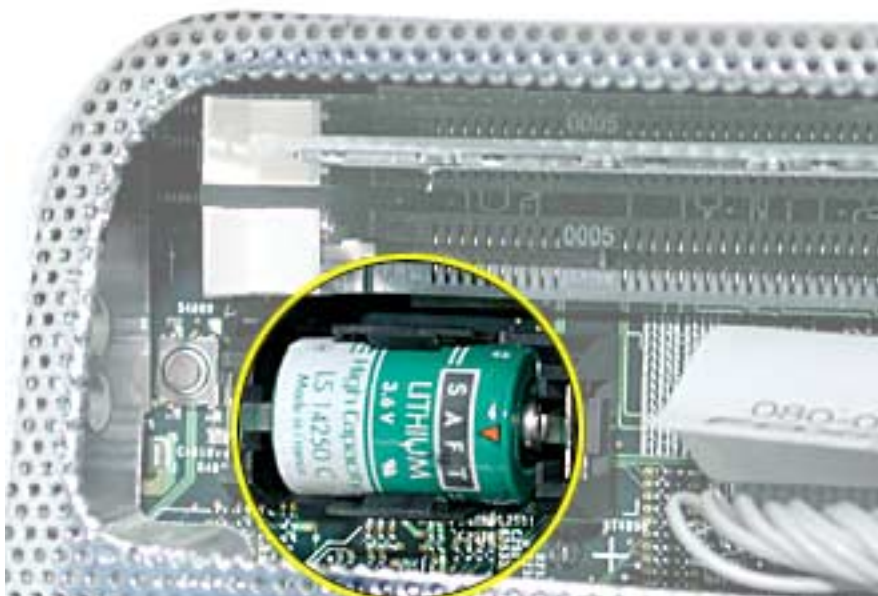



I/O Panel

Tools

This procedure requires the following tools:

- Phillips #2 screwdriver

Part Location



Preliminary Steps

Before you begin, do the following:

- Place the computer face down on an ESD mat.
- Remove the user access door.
- Remove the feet.
- Remove the rear housing.
- Discharge the CRT.
- Remove the fan.
- Remove the Faraday cage.
- Remove the digital module assembly.

Procedure

1. Remove the two I/O panel screws.



2. Remove the I/O panel off the logic board.





Modem

Tools

This procedure requires the following tools:

- Phillips #1 or jeweler's screwdriver

Part Location



Preliminary Steps

Before you begin, do the following:

- Place the computer face down on an ESD mat.
- Remove the user access door.
- Remove the feet.
- Remove the rear housing.
- Discharge the CRT.
- Remove the fan.
- Remove the Faraday cage.
- Remove the digital module assembly.

Procedure

1. Remove the two modem screws.

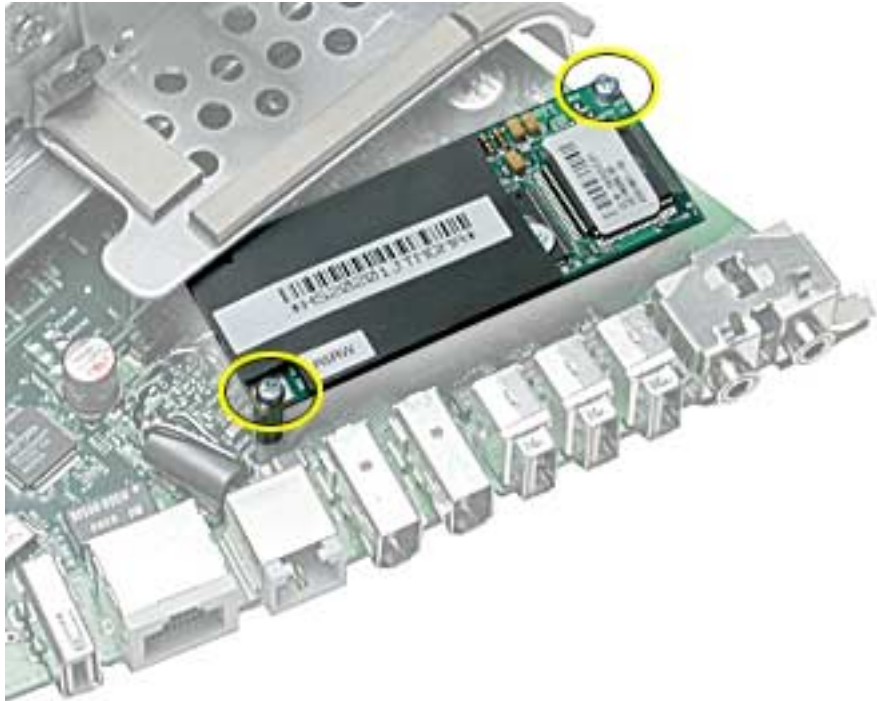

2. Disconnect the RJ-11 cable from the modem. Remove the modem.

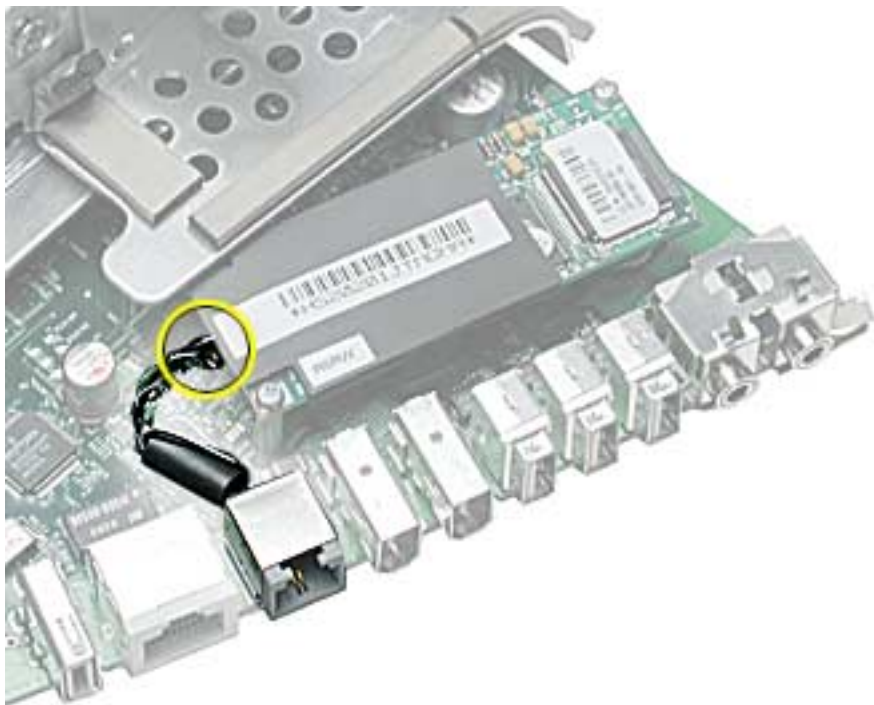



RJ-11 cable

Tools

No tools are required for this procedure

Part Location



Preliminary Steps

Before you begin, do the following:

- Place the computer face down on an ESD mat.
- Remove the user access door.
- Remove the feet.
- Remove the rear housing.
- Discharge the CRT.
- Remove the fan.
- Remove the Faraday cage.

- Remove the digital module assembly.
- Remove the I/O panel

Procedure

1. Disconnect the RJ-11 cable from the modem.

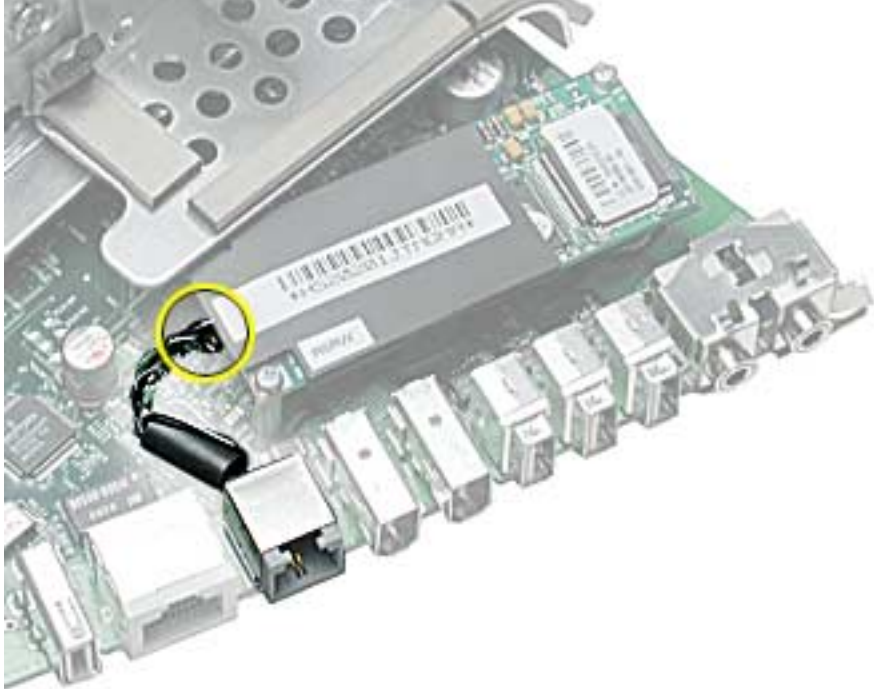

2. With an anti-static tool, push and then pull the RJ-11 port off the logic board.

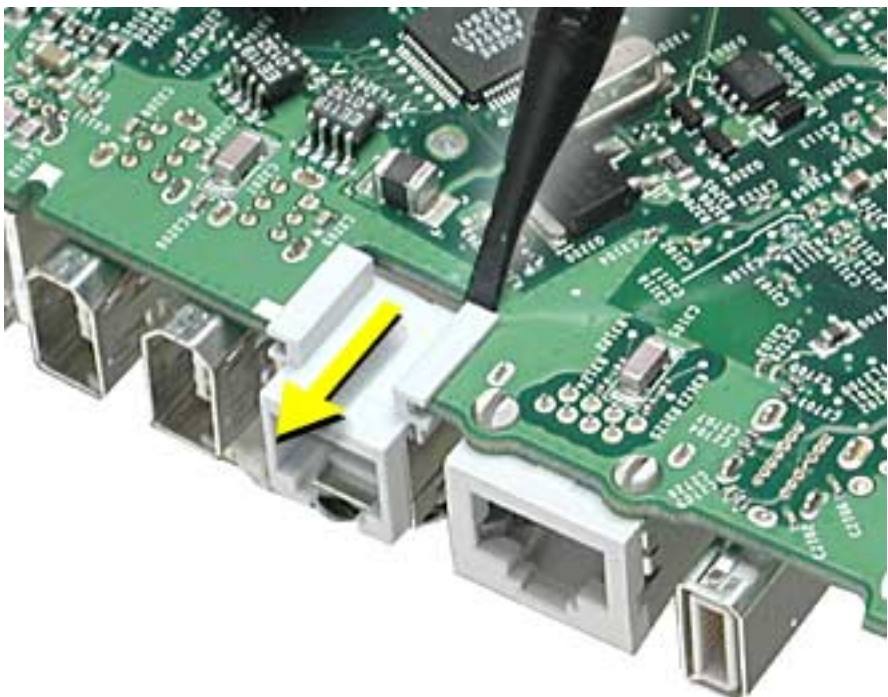



Optical Drive

Tools

This procedure requires the following tools:

- Phillips #2 screwdriver

Part Location

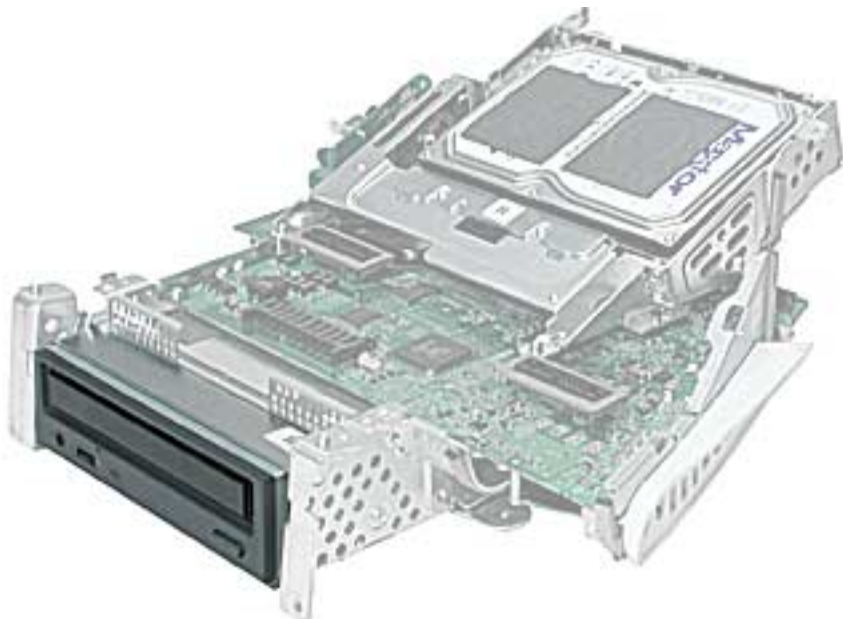

Preliminary Steps

Before you begin, do the following:

- Place the computer face down on an ESD mat.
- Remove the user access door.
- Remove the feet.
- Remove the rear housing.
- Discharge the CRT.
- Remove the fan.
- Remove the Faraday cage.
- Remove the digital module assembly.
- Remove the hard drive.
- Remove the heatsink.
- Remove the logic board.

Procedure

1. Remove two screws on the right side of the optical carrier.

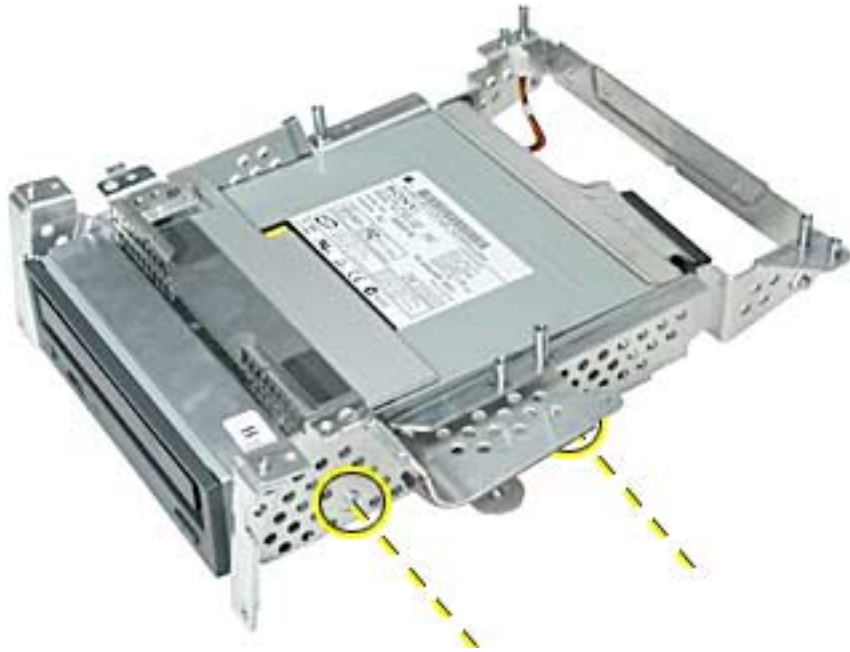

2. Remove two screws on the left side of the optical carrier.



3. Flip the optical carrier over and disconnect the optical power cable and the optical data cable.



4. Remove the cotter pin (#1) from the carrier. Next, lift the heatshield by the metal fence (#2), and lastly remove the heatshield in the direction of the arrow (#3) to detach it from the carrier.



-
- Slide the optical drive out of the carrier by pushing it from the back end where the EMI cap is located. **Note:** The EMI cap is not attached to the carrier or the optical drive.

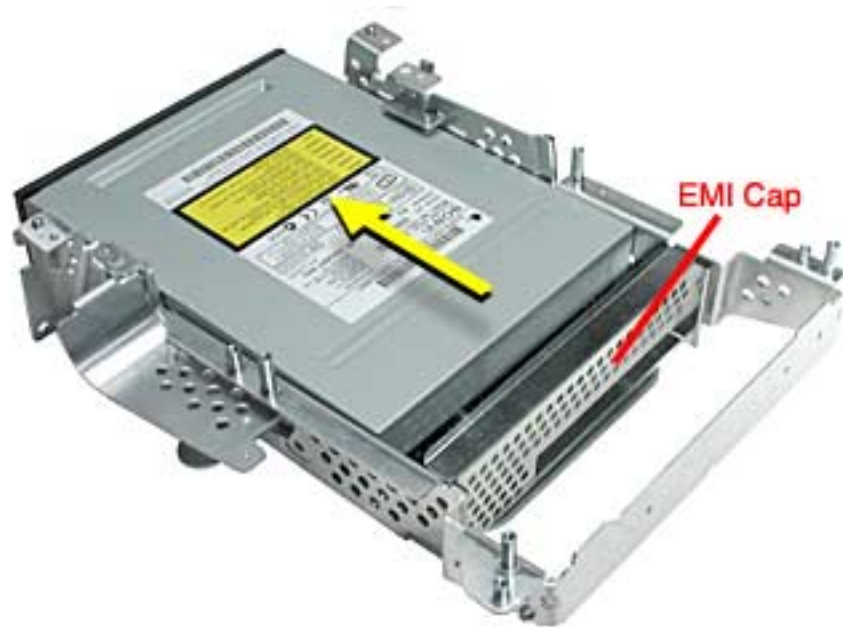



Display/Analog Assembly

Tools

This procedure requires the following tools:

- No tools are required

Warning: This product contains high voltage and a high-vacuum picture tube. To prevent injury, always review CRT Safety on Service Source online. This link can be found under the list of topics under the iMac icon. Remember, never use a grounding wriststrap until after discharging the CRT and setting up an ongoing ground connection.

Note: The eMac display/analog assembly requires no voltage calibration or geometry adjustment. Should the display require adjustment (focus, color, or brightness) use the “Displays” pane under System Preferences if using Mac OS X. If using Mac OS 9, use the Monitor Control Panel to make adjustments. If you can not make satisfactory corrections with these tools, replace the display/analog assembly.

Part Location



Preliminary Steps

Before you begin, do the following:

- Place the computer face down on an ESD mat.
- Remove the user access door.
- Remove the feet.
- Remove the rear housing.
- Discharge the CRT.
- Remove the fan.
- Remove the Faraday cage.
- Remove the digital module assembly.
- Remove the AirPort card guide.
- Remove the front bezel
- Remove the antenna.

If you remove everything listed in the preliminary steps above, you are left with the display/analog module. There is nothing more to remove from this module.

Note: The display/analog assembly contains a non-switching power supply which is preset at a 220V configuration. The voltage selection needs to be manually set by the way of a voltage jumper. This means if you are operating the computer in a 110V environment, you will have to install the voltage jumper. Refer to the Troubleshooting chapter, “Digital/Analog”

Replacement Note: If you are returning a defective display/analog module, it is imperative that proper packaging guidelines be followed. The packing procedure is included with the replacement assembly. Incorrect packaging can result in damaged eMac displays. Please read and follow the directions enclosed in the shipping box of the new display prior to packaging the defective module.

Failure to package the defective module according to the instructions may result in liability for the cost of the damaged display.



LHR Coil

Tools

This procedure requires the following tools:

- Phillips #2 screwdriver

Part Location

Note: This part is used in Europe for line conditioning. If your computer does not have the LHR, skip this procedure.



Preliminary Steps

Before you begin, do the following:

- Place the computer face down on an ESD mat.
- Remove the user access door.
- Remove the feet.
- Remove the rear housing.
- Discharge the CRT.

Procedure

1. Remove the screw located at the bottom of the LHR module.

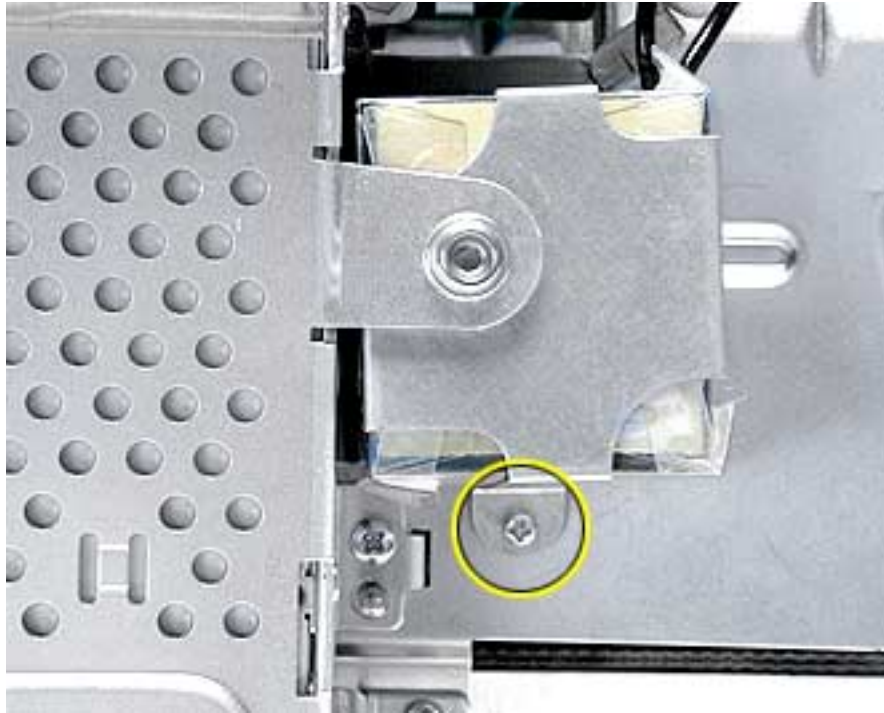

2. Disconnect the LHR connector located next to the fuse and to the right of the fan.



3. Disengage the tabs on the LHR. **Note:** The tabs (circled below) clip into the divider panel. Remove the LHR from the divider panel.

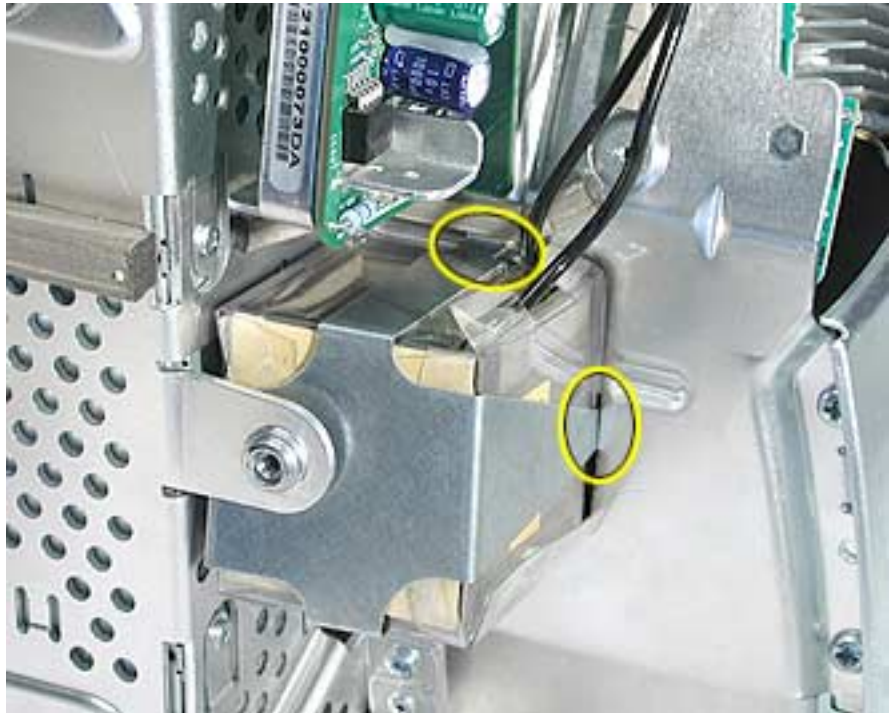



Troubleshooting

eMac



General Information

What's New

1. **Important:** The display/analog assembly contains a non-switching power supply preset at a 220V configuration. The voltage selection needs to be manually set by the way of a voltage jumper. If you are operating the computer in a 110V environment, you will have to install the voltage jumper. Refer to “Display/Analog Voltage Setting and LHR Module Instructions” discussed later in this chapter.
Note: The LHR coil (line conditioning module) is used in some international countries. Refer to the Take Apart chapter, LHR topic, for take-apart information.
2. **Important:** If you are returning a defective display/analog assembly, it is imperative that proper packaging guidelines be followed. The packing procedure is included with the replacement assembly. Incorrect packaging can result in damaged eMac displays. Please read and follow the directions enclosed in the shipping box of the new display prior to packaging the defective module. Failure to package the defective module according to the instructions may result in liability for the cost of the damaged display.
3. **Important:** Do NOT lift, handle, bump, or manipulate the CRT neck/neck board on the Display/Analog assembly. Modules damaged by mishandling are NOT covered by Apple Warranty. Apple Authorized Service Providers can be liable for broken CRT necks due to improper handling. Refer to “CRT Neck/ Display/Analog Assembly Handling Information” topic in this chapter for more information.
4. The eMac display/analog assembly requires no voltage calibration or geometry adjustment. Should the display appear to require adjustment (focus, color, or brightness) use the “Displays” pane under System Preferences if using Mac OS X. If using Mac OS 9, use the Monitor Control Panel. If you can not make satisfactory corrections with these tools, replace the display/analog assembly.
5. **Important:** The microprocessor uses a heatsink/thermal pipe to transfer heat away. Whenever the heatsink is removed, the bottom side of the heatsink and the top of the microprocessor must be cleaned and thermal paste must be applied to the microprocessor. If the mating surfaces are not cleaned and thermal paste is not applied, the CPU may overheat and become damaged. Refer to “Thermal Paste Application” in this chapter.
6. The hard drive has 3 thermal pads. If the thermal pads become damaged, replace them.
7. The eMac has an optional stand. Refer to the Upgrades chapter or the CIP procedures for instructions on how to install the stand.
8. The computer has a Power PC G4 microprocessor, running at a clock speed of 700 MHz.
9. The computer comes with 128 MB of SDRAM installed. Two DIMM slots support up to 1 GB using 128 MB, 256 MB, or 512 MB DIMMs. The SDRAM modules are PC-100, 168-pin DIMMs.
10. The computer comes with either tray-loading CD-ROM or DVD-ROM/CD-RW (combo drive).

-
11. The 56K fax modem is only available on the DVD-ROM/CD-RW (combo drive) model.
 12. The eMac uses a different A/C power cord; power cords from older iMac models may not fit into the A/C socket.

Logic Board, Top

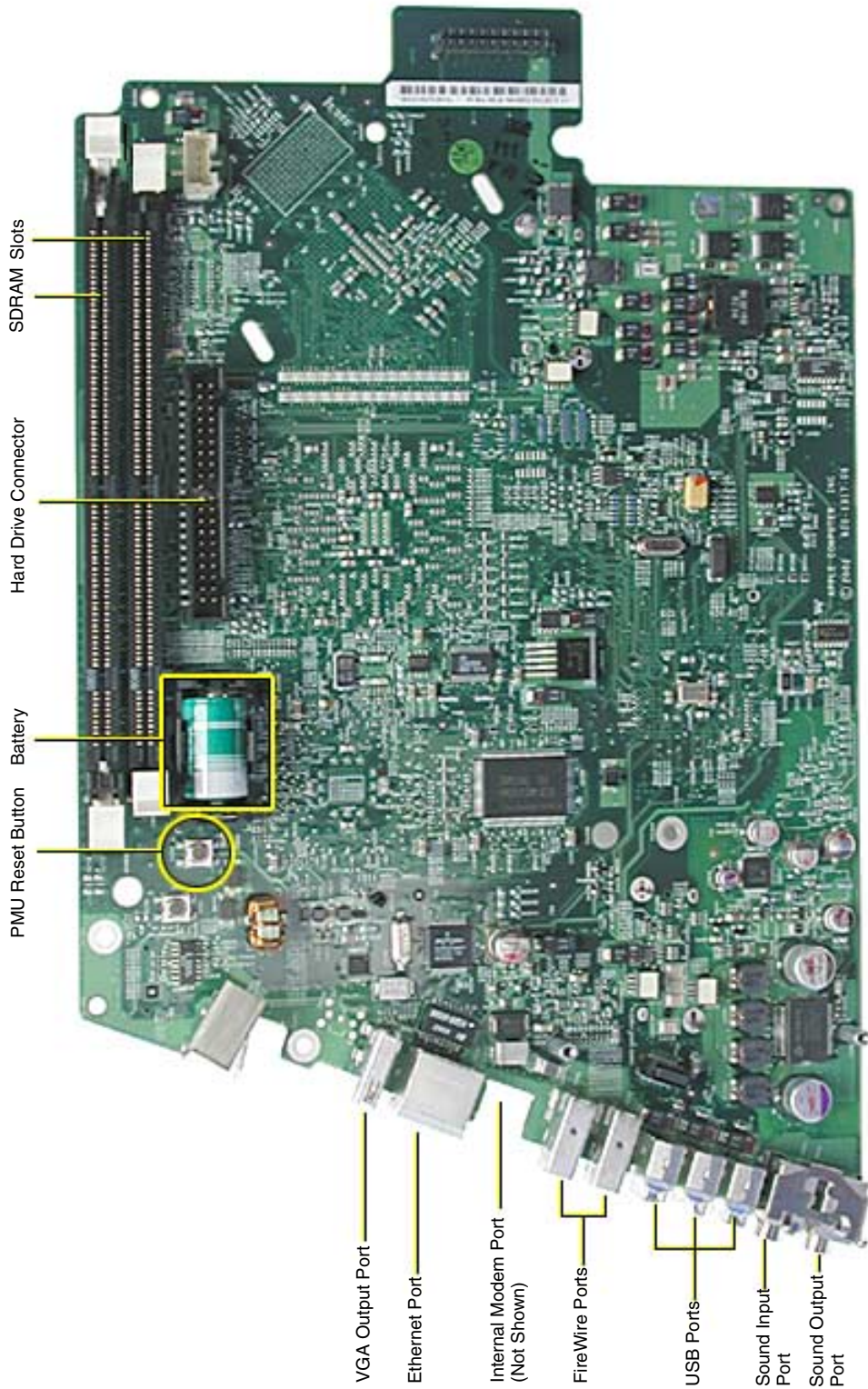

Logic Board, Bottom

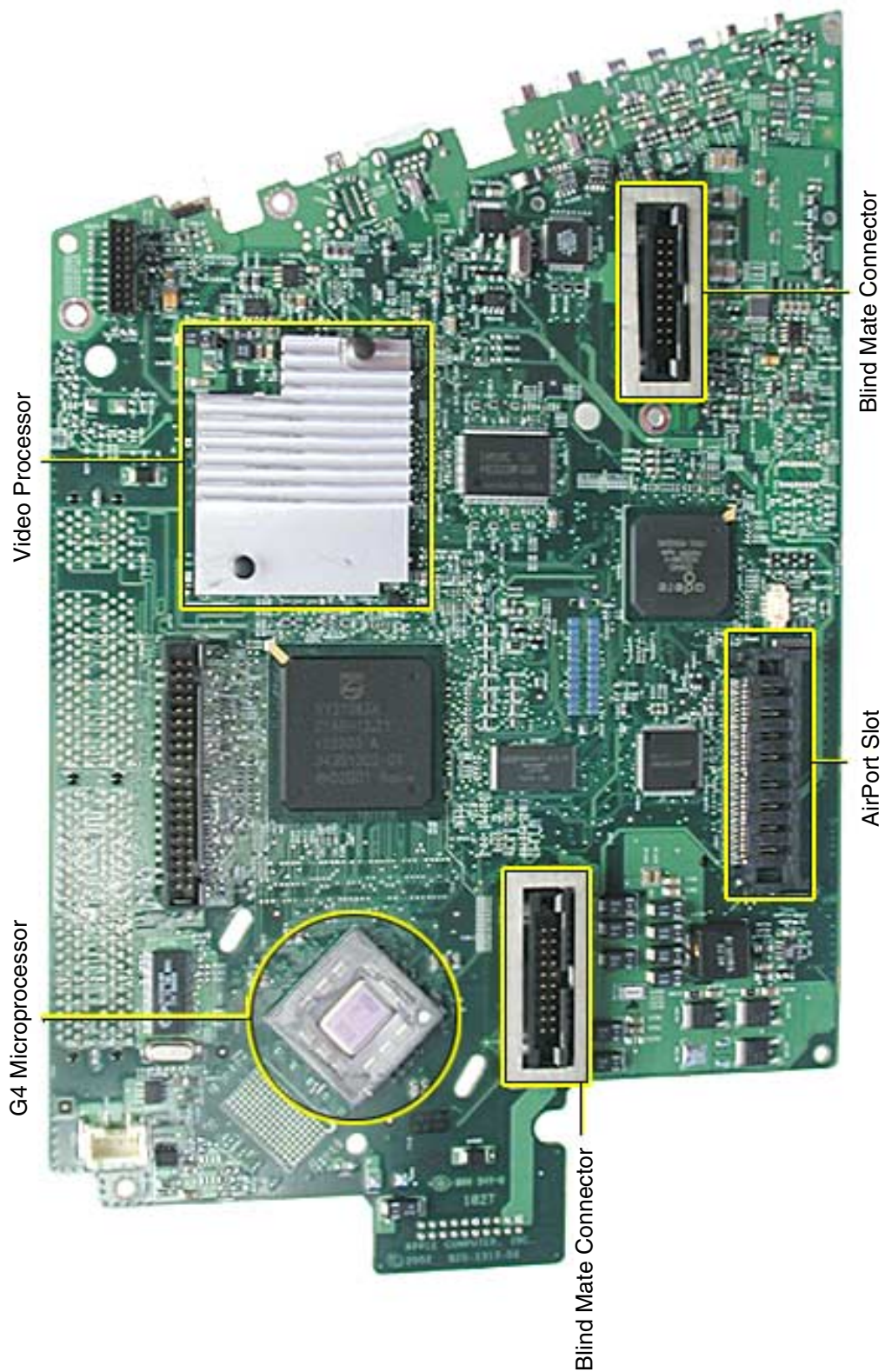

I/O Ports

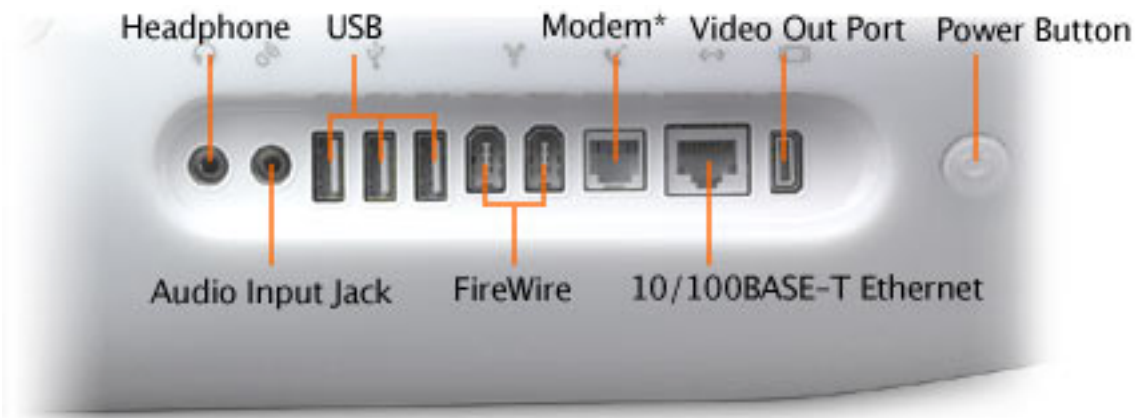

The PMU Chip

The PMU (Power Management Unit) is a micro controller chip that controls all power functions for the computer. The PMU is a computer within a computer. It has memory, software, firmware, I/O, two crystals, and a CPU. Its function is to:

- Tell the computer to turn on, turn off, sleep, wake, idle, etc.
- Manage system resets from various commands.
- Maintain parameter RAM (PRAM).
- Manage the real-time clock.

Important: The PMU is **very** sensitive and touching the circuitry on the logic board can cause the PMU to crash. If the PMU crashes, the battery life goes from about five years to about two days if the PMU is not reset. Refer to the next topic, “Resetting the PMU on the Logic Board” for the procedure.

Many system problems can be resolved by resetting the PMU chip. The PMU reset button is located behind the user access door, refer to the graphic below.

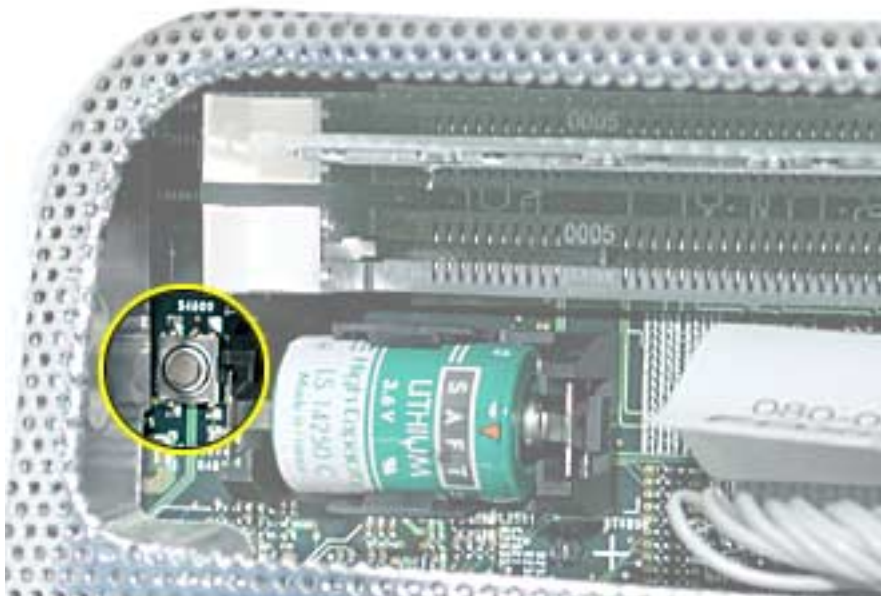

Location of the PMU Reset Button

Resetting the PMU on the Logic Board

Resetting the PMU (Power Management Unit) on the logic board can resolve many system problems. Whenever you have a unit that fails to power up, you should follow this procedure before replacing any modules.

1. Save open documents and quit all open applications.
2. Turn the computer off by choosing Shut Down from the Special menu (if using Mac OS 9), or choose Shut Down from the Apple menu if using OS X.
3. Remove the user access door.



- 4 Unplug all cables, except the power cord, from the computer.



- 5 Touch a metal surface inside the computer. Then unplug the power cord. This helps protect the computer from damage caused by electrostatic discharge. **Important:** To avoid electrostatic discharge, always ground yourself by touching metal before you touch any parts or install components inside the computer. To avoid generating static electricity, do not walk around the room until you have finished the procedure and closed the computer.



- 6 Press the PMU reset button (shown below) once and then proceed to step 7. Do **NOT** press the PMU reset button a second time because it could crash the PMU chip.

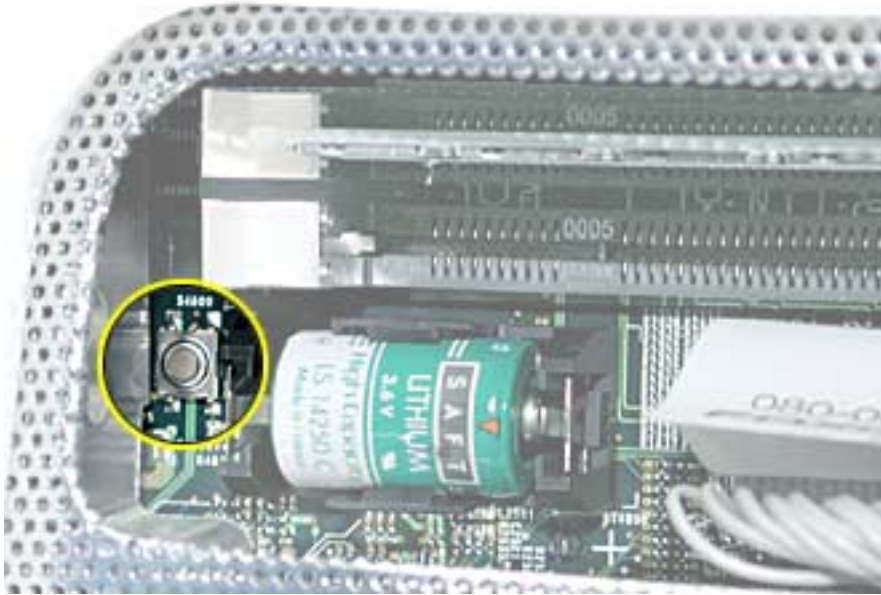

- 7 WAIT ten seconds before connecting the power cord and powering the computer on. If the computer powers on, go to the next step. If the computer does not power on, there is something else wrong with the computer, refer to the symptom/cure, “No Power” in this chapter.
- 8 Run MacTest Pro and return the computer to the customer.

Note: This entire procedure resets the computer’s PRAM. Be sure to reset the computer’s time, date and other system parameter settings before returning the computer to the customer.

Power-On Self Test

There is a power-on self test that resides in the ROM of the eMac. This test automatically runs whenever the eMac is powered on after being fully shut down (the power-on self test does not run if the machine is only restarted).

If a problem is detected during the test, you will not hear a normal startup chime. Instead, the system will beep as explained below. Refer to “Error Beeps” later in this chapter for instructions on how to troubleshoot and repair an eMac that sounds error beeps at startup time.

Following is a definition of what the error beeps at startup time signify.

One Beep: No RAM is installed or detected.

Two Beeps: Incompatible memory is installed. (The slots accept standard PC-100 or PC-133, 168-pin DIMMs).

Three Beeps: No RAM banks passed memory testing.

Four or Five Beeps: Bad checksum for the remainder of the boot ROM. The ROM is bad.

Logic Board Battery

Important: Apple highly recommends removing the battery when handling the logic board. Make sure to use proper ESD protection when handling modules.

The battery on the logic board controls the stored system settings, such as date and time. It is only necessary to test the battery when you can't power on the computer, or the date and time are reset every time the AC power is removed.

The battery is also used to power the PMU chip (because the PMU chip keeps time and must always be running) when the computer is unplugged from the wall (AC power). The PMU is **very** sensitive and touching any circuitry that is connected to the PMU can cause it to crash. If the PMU crashes, the battery life goes from about five years to about two days if the PMU is not reset. Once the battery goes dead, the PMU will reset the time and date every time the AC power is removed. To fix this situation, replace the battery and reset the PMU (refer to "Resetting the PMU on the Logic Board" mentioned earlier in this chapter).

Testing the Battery

If the computer has a "No Power" situation, check the battery before replacing modules. A drained battery may be indicative of a crashed Power Management Unit.

With the battery in the battery holder (under load), measure the voltage across the battery's positive and ground terminals.



Does the battery measure at least +3.5v? If not, replace the battery and reset the PMU. If the battery does measure over +3.5v, reinstall the battery and reset the PMU as above

Connect the power cord and power up the system again.

Display/Analog Voltage Setting and LHR Module Instructions

The display/analog assembly contains a non-switching power supply which is preset at a 220V configuration. The voltage selection needs to be manually set by the way of a voltage jumper. This means if you are operating the computer in a 110V environment, you will have to install the voltage jumper.

The following instructions explain how to configure the voltage and LHR jumpers on the digital/analog assembly. **Note:** The LHR (a line conditioning module) is required in some international countries.

Refer to Table 1 for jumper settings and refer to Figures 1, 2, and 3 for jumper and LHR locations.

Tools

This procedure requires the following tools:

- needlenose pliers to remove/attach the voltage jumper
- phillips #2 screwdriver if attaching the LHR module

Table 1: Jumper Settings

Voltage Environment	Voltage Jumper Setting	LHR Jumper Setting
110 V	Jumper is on	Jumper is on
220 V no LHR module	Jumper is off	Jumper is on
220 V with LHR module	Jumper is off	Jumper is off

Procedure

1. Locate the voltage jumper circled below in Figure 1. **Note:** this jumper won't be installed on a 220V computer. Next, refer to Table 1 (on the previous page) for the voltage jumper setting and set the jumper accordingly. **Warning:** Be careful around the CRT. Discharge the CRT before removing or replacing the jumper.

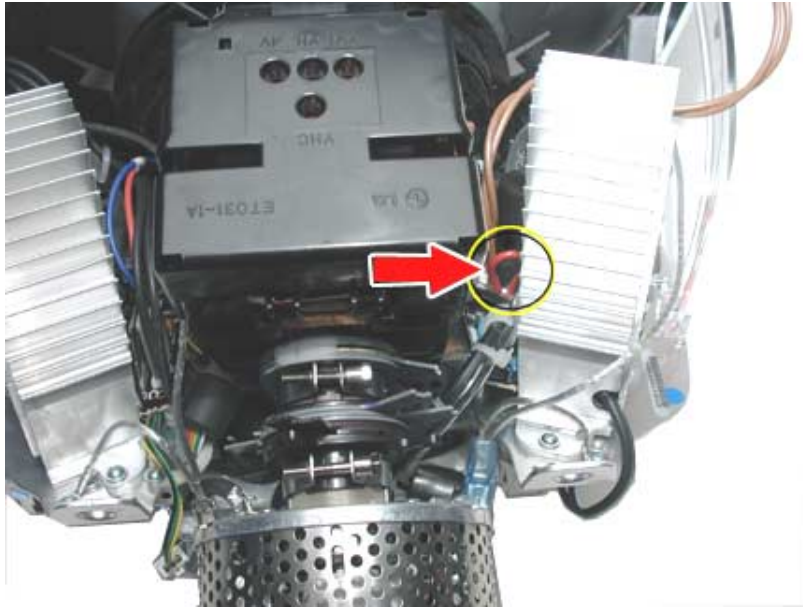

Figure 1: Voltage Jumper Locator

2. Locate the LHR coil jumper circled in Figure 2. Then refer to Table 1 for the LHR jumper setting and set the jumper accordingly.



Figure 2: LHR Jumper Locator

-
3. Identify if you have the LHR coil (Figure 3) on the eMac. **Note:** The LHR coil (a line conditioning module) is required in some international countries.



Figure 3: LHR Module Locator

4. If you don't have an LHR module, install the replacement display/analog assembly and ensure the jumpers are set correctly. If you have an LHR, go on to step 5.
5. Remove the LHR from the faulty display/analog assembly, place the LHR on the replacement digital/analog assembly, and set the jumpers according to Table 1.

Thermal Paste Application

The microprocessor uses a heatsink/thermal pipe to transfer heat away. Whenever the heatsink is removed, the bottom side of the heatsink and the top of the microprocessor must be cleaned and thermal paste must be applied. If the mating surfaces are not cleaned and thermal paste is not applied, the CPU may overheat and become damaged.

Tools

This procedure requires the following tools:

- Plastic stylus or nylon probe tool (922-5065) to remove the old thermal paste
- Thermal paste (922-4757), each tube contains 4-5 applications

Procedure

1. Thoroughly clean the thermal film from the heatsink surface with a plastic stylus or the nylon probe tool. Do not use an abrasive material or liquid cleaner. **Important:** Be extremely careful not to bend the heatpipes on the heatsink.



- Carefully clean the surface of the microprocessor with a plastic stylus or nylon probe tool (922-5065) to remove the old thermal paste.



- Squeeze a drop of thermal paste onto the middle of the microprocessor as shown.



4. Spread the paste evenly over the processor.



5. Reinstall the heatsink.



CRT Neck/Display/Analog Assembly Handling Information

Handling

Important: It is imperative that proper handling and packaging guidelines be followed when working with the display/analog assembly.

Do NOT lift, handle, bump, or manipulate the CRT neck/neck board (see red arrows below) on the Display/Analog assembly. Modules damaged by mishandling are NOT covered by Apple Warranty. Apple Authorized Service Providers can be liable for broken CRT necks due to improper handling.

Caution: The metal chassis has sharp edges, you may want to wear gloves when handling the assembly. Lift the assembly from the metal chassis; never lift the assembly from the neck. I



Packing a Defective Display/Analog Assembly

The packing procedure is included with the replacement display/analog assembly. Incorrect packaging can result in damaged eMac displays. Please read and follow the directions enclosed in the shipping box of the new display prior to packaging the defective assembly. AASPs can be liable for broken CRT necks due to improper packing and handling.



Symptom Charts

How to Use the Symptom Charts

The Symptom Charts included in this chapter will help you diagnose specific symptoms related to the product. Because cures are listed on the charts in the order of most likely solution, try the cures in the order presented. Verify whether or not the product continues to exhibit the symptom. If the symptom persists, try the next cure.

Note: If you have replaced a module, reinstall the original module before you proceed to the next cure.

Apple Hardware Test

Apple Hardware Test is a diagnostic tool for detecting problems with Apple internal hardware components such as logic board, memory, modem, video RAM, and Apple AirPort Card. The test does not check externally connected hardware components such as USB or FireWire devices; it also does not check non-Apple devices such as third-party PCI cards.

Note: The most recent Apple Hardware Test software can be downloaded from the CD Images page on AppleCare Service Source; go to the Service Source home page and select 'Disc Images' from the quick-click table.

Error Codes

If Apple Hardware Test detects a problem with a computer, it displays an error code, which is defined in the product's Error Code List. Consult the list for appropriate repair procedures associated with the code.

All Error Code Lists are included in the Service Diagnostics Matrix, Knowledge Base article 112125. You can also access this matrix by clicking the Service Diagnostics rollover link under any of the product areas on the Service Source home page.

No Power

The computer will not power on.

1. Verify the power outlet is good. Plug a different device into the socket to ensure there is power, or plug computer into another outlet.
2. Check the power cord. Use a known good power cord.
3. Check connection of the power cord on both ends. Verify that the plug is securely plugged into both the A/C outlet and back of the computer.
4. Remove keyboard, mouse, and other peripherals such as speakers.
5. Position the computer so it rests on the CRT face.
6. Remove the user access door.
7. Touch a metal surface inside the computer.



8. Unplug the unit.
9. Verify the battery is good before replacing modules. A drained battery may be indicative of a crashed Power Management Unit. Does the battery measure at least +3.5v? If not, replace the battery and reset the PMU.
10. Reset PMU. Refer to “Resetting the PMU on the Logic Board” mentioned earlier in this chapter.

11. Remove the rear housing.

Warning: This product contains high voltage and a high-vacuum picture tube. To prevent serious injury:

- Review the CRT safety information on Service Source online.
- Discharge the CRT
- Never use a grounding wriststrap until after discharging the CRT and setting up an ongoing ground connection.

12. Check the power button. Attach a known good power button to the unit. Do you have power now? If yes, replace the power button. If no, go to the next step.

13. Unplug the unit. **Warning:** Make sure the ground screw (see below) is attached to the frame when testing power.

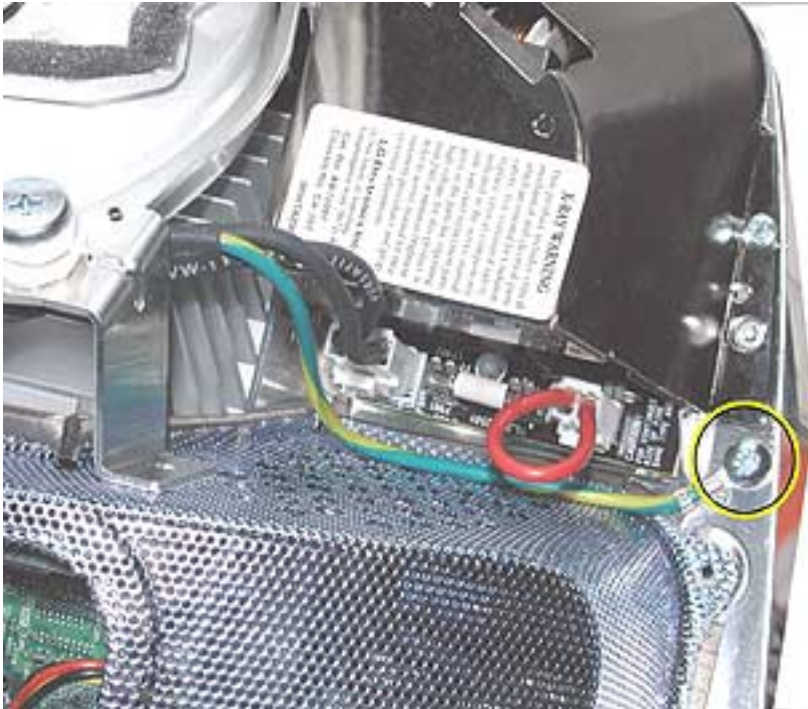

14. Check the AC connector. Make sure it's connected. Do you have power now? If yes, test the unit and return it to the customer. If no, go to the next step.



15. **Warning:** Make sure the computer is unplugged. Check the fuse (see graphic below). You will need an ohm meter to do a continuity test on the fuse. Using an ohm meter, touch the red and black probes to the two metal points at location F901 and check for continuity (reading of “0”). If the ohm meter registers “0”, the fuse is good. If the meter registers “infinite”, the display/analog assembly should be replaced.

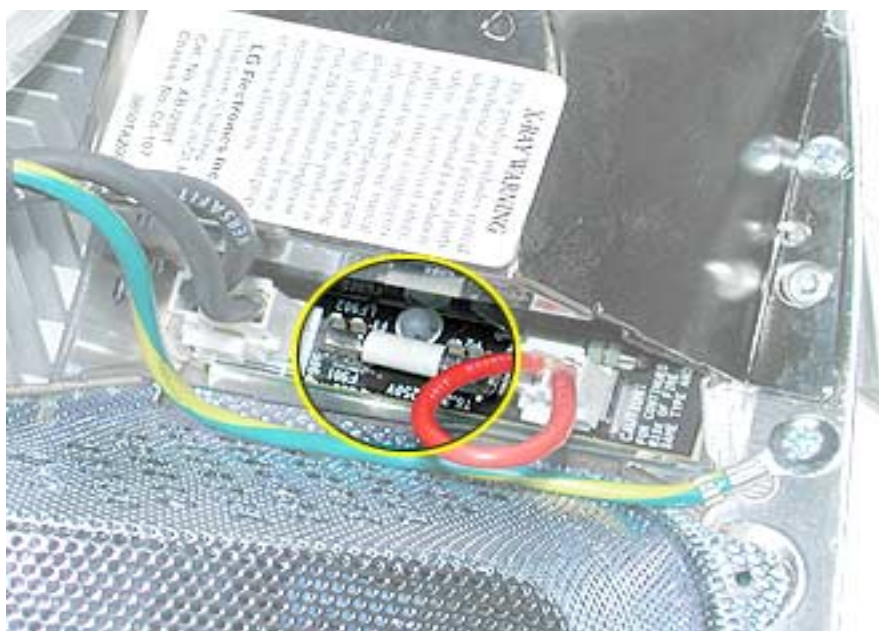

16. Plug the unit in. Check for AC voltage (see below). **Warning:** Do not force the probes into the connector. Doing so could break the connector. Do you measure 120V (line voltage)? If yes, go on to the next step. If no, replace the display/analog assembly.



17. Make sure the computer is plugged in. Check for 5V trickle on capacitor C3202 (located near the modem board) on the logic board (see graphic below). Do you get 5V? If yes, go to the next step. If no, replace the display/analog assembly.

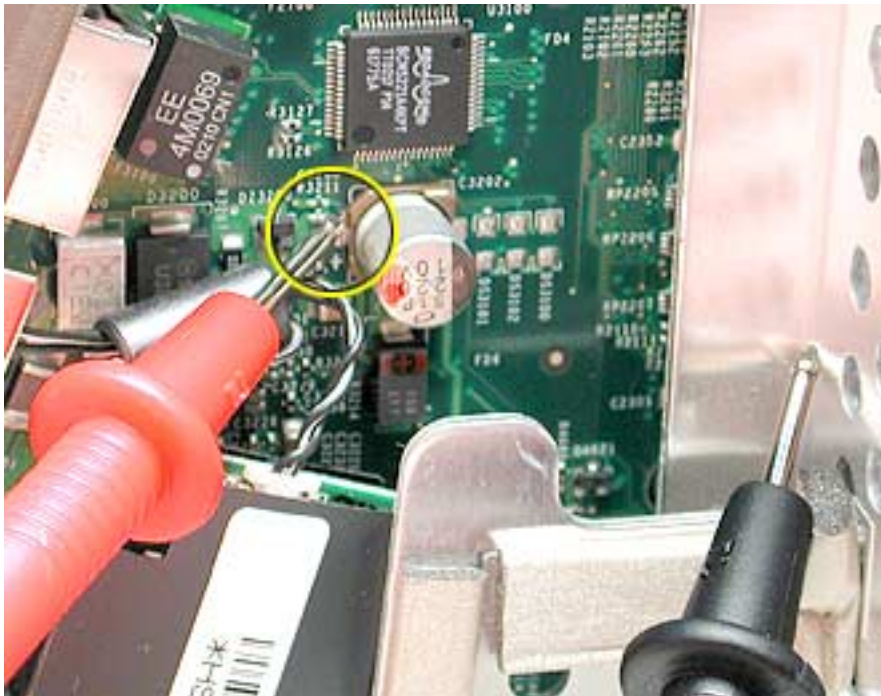

18. Check the down converter connector. Verify that it is properly connected.



19. Plug the unit in, but don't press the power button. Check the down converter. **Be extremely careful when checking voltages. It is easy to short between the pins.** Ground to the frame with the black probe and check pin 1 on P801 with the red probe. A reading of 10.5V up to 17.5V is acceptable. If you get a reading in that range, replace the display/analog assembly. If not, replace the logic board.

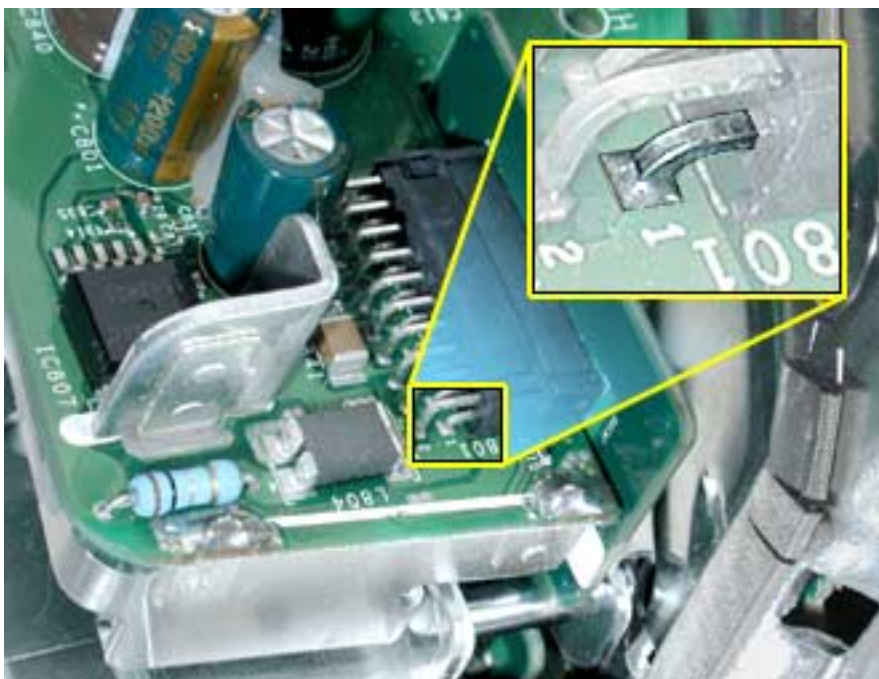

Random Shut Down

While using the computer it just shuts down for no reason.

1. Check the jumper settings, make sure they are set correctly. Refer to the “Digital/Analog Voltage Setting and LHR Module Instructions” mentioned earlier in this chapter. **Note:** There is one jumper for the voltage and one jumper for the LHR coil. Both jumpers should be installed when the computer is operating in the 110V environment. If the jumpers are set correctly, refer to “No Power”.



Voltage Jumper Location



LHR Coil Jumper Location

No Video

No video to the internal display, the fan is spinning, there is drive activity

1. Reset parameter RAM. Press Command-Option-P-R during startup.
2. The system software could be damaged. Start up from the system CD that came with the computer.
3. Remove the user access door.
4. Touch a metal surface inside the computer.



5. Disconnect the A/C power cord. Press the PMU reset button on the logic board. Refer to “Resetting the PMU on the Logic Board” mentioned earlier in this chapter.
6. Check for external video. Connect an external monitor to the video out port. Did you get external video? If yes, replace the display/analog assembly. If no, go on to the next step.
7. Replace the main logic board.

Vertical Raster Shift

The raster moves up to the point where the menu bar is no longer visible. Replace the IVAD cable (922-5806). Follow the procedure below.

Tools

This procedure requires the following tools:

- 2.5 mm hex tool
- Phillips #2 screwdriver
- Hot-melt glue gun (recommended)
- Nylon probe tool (922-5065)

Procedure

1. Remove the rear housing from the eMac.
2. Discharge the CRT. **Warning:** This product contains high voltage and a high-vacuum picture tube. To prevent injury, review the Service Foundations course: "CRT Displays" for safety information.
3. Locate the IVAD assembly shown below.

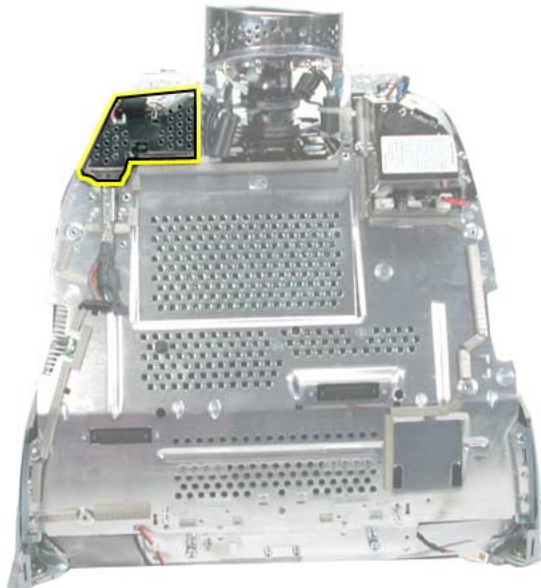

- Note:** The screws on IVAD assembly need to be removed to access one end of the IVAD cable. Remove the screw (circled below) and then remove the metal cable cover.

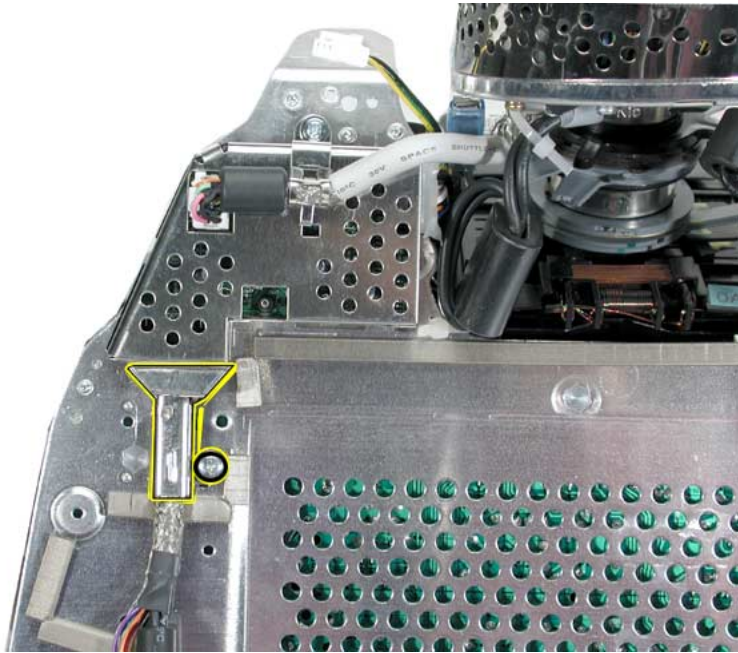

- Remove the remaining two screws on the IVAD assembly.

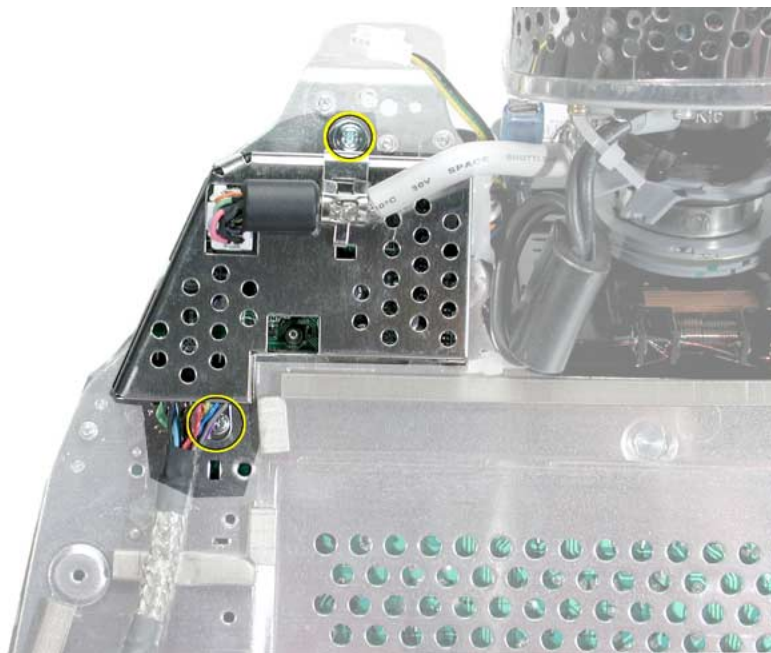

6. With the nylon probe tool or needlenose pliers, remove the glue from the connector. **Note:** If you find it difficult removing the glue use a heat gun to soften the glue a bit and then remove it. Disconnect the cable after removing the glue.

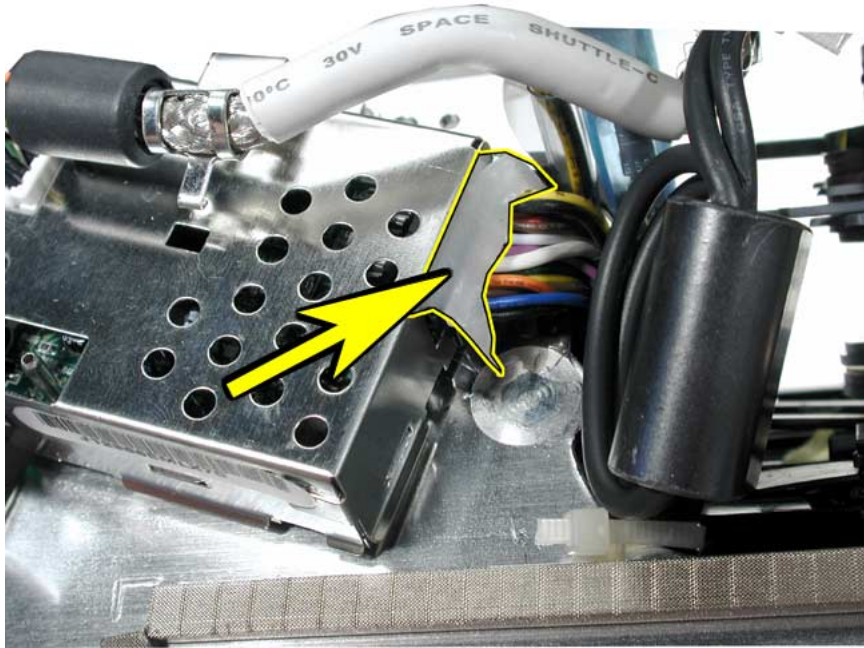

7. Locate the other end of the IVAD cable.

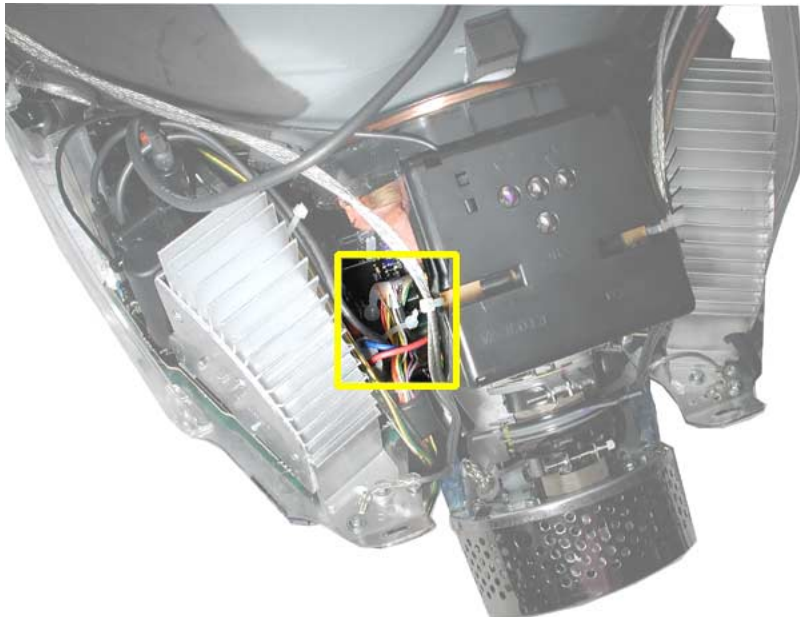

8. With the nylon probe tool or needlenose pliers, remove the glue from the cable connector.
Note: If you find it difficult removing the glue use a heat gun to soften the glue a bit and then remove it.

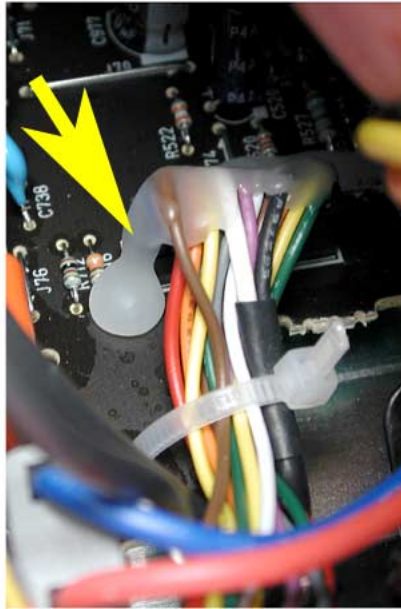

9. Clip the cable tie. Disconnect the IVAD cable from the board.

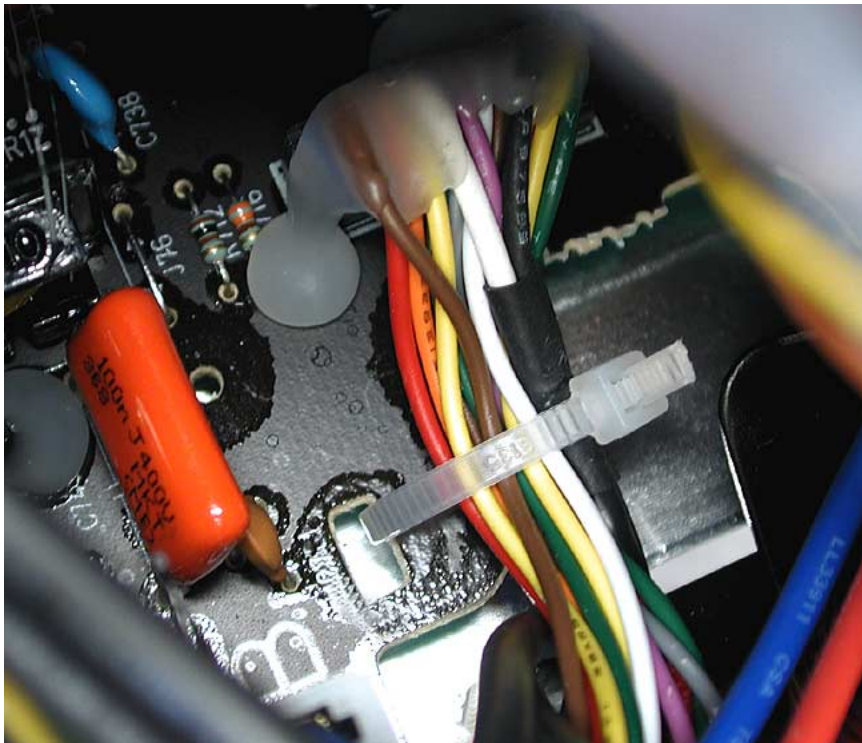

IVAD Cable Replacement Procedure

1. Install the replacement IVAD cable.
2. Replace the cable tie (shown on the previous page).
3. Place hot glue on each end of the IVAD connector.
4. Reassemble the computer and test the system.

Mass Storage

Flashing question mark appears on the screen

1. Boot from the system CD that came with the computer and see if the hard drive mounts on the desktop.
2. Launch Drive Setup and update the hard drive driver.
3. If no hard drive is found in Drive Setup, verify the hard drive cable connections.
4. Replace the hard drive cable.
5. Reinstall the software drivers for the hard drive.
6. Reinstall system software. **Note:** Backup the data first.
7. Reinitialize the hard drive.
8. Replace the hard drive.
9. Replace the logic board.

Alternating flashing question mark and a flashing Mac OS face on a folder.

1. This symptom could indicate damaged system software or non-compatible system software. Boot from the system CD that came with the computer and see if the hard drive mounts on the desktop.
2. Launch Drive Setup and update the hard drive driver.
3. If no hard drive is found in Drive Setup, verify the hard drive cable connections.
4. Replace the hard drive cable.
5. Reinstall the software drivers for the hard drive.
6. Reinstall system software. **Note:** Backup the data first.
7. Reinitialize the hard drive.
8. Replace the hard drive.
9. Replace the logic board.

Hard drive spins, but won't mount to the desktop

1. Disconnect any connected peripherals.
2. Boot from the system CD that came with the computer and see if the hard drive mounts on the desktop.
3. Launch Drive Setup and update the hard drive driver.
4. If no hard drive is found in Drive Setup, verify the hard drive cable connections.
5. Replace the hard drive cable.
6. Replace the hard drive.
7. Replace the logic board.

Hard drive does not spin.

1. Disconnect any connected peripherals.
2. Boot from the system CD that came with the computer and see if the hard drive mounts on the desktop.
3. Launch Drive Setup and update the hard drive driver.
4. If no hard drive is found in Drive Setup, verify the hard drive cable connections.
5. Replace the hard drive cable.
6. Replace the hard drive.
7. Replace the logic board.

System hangs during normal startup process

1. Boot from the system CD that came with the computer and see if the hard drive mounts on the desktop.
2. Using Drive Setup, reinstall the system software drivers for the hard drive.
3. Using Drive Setup, reinitialize the hard drive.
4. Check all cable connections to and from the hard drive.
5. Replace the hard drive cable.
6. Replace the hard drive.
7. Replace the logic board.

CD or DVD tray won't open

1. Check for obstructions on the optical drive door.
2. Replace the optical drive cable.
3. Replace the optical drive.
4. Replace the logic board.
5. Replace the down converter.

Optical drive won't accept a CD or DVD

1. Check for obstructions on the optical drive door.
2. Replace the optical drive cable.
3. Replace the optical drive.
4. Replace the logic board.
5. Replace the down converter.

CD or DVD disc constantly ejects at startup

1. Try cleaning the disc. If it is dirty or scratched, it may not mount.

-
2. Try a known good disc.
 3. Disconnect all peripheral devices, especially the mouse in cases where the disc is constantly ejecting. This symptom may be an indication of a failed mouse giving a signal that the mouse is stuck in the down position. Try a known good mouse.
 4. Boot from Apple Hardware Test (hold down the “C” key at startup) or boot from the system install CD (use Startup Manager, hold down the Option key at startup).
 5. Perform a clean install with the CD that came with the computer.
 6. Replace the optical drive cable.
 7. Replace the optical drive.
 8. Replace the logic board.

Optical drive doesn’t spin

1. Replace the optical drive cable.
2. Replace the optical drive.
3. Replace the logic board.
4. Replace the down converter.

CD or DVD won't mount to the desktop

1. Try cleaning the disc. If it is dirty or scratched, it may not mount.
2. Try a known good disc.
3. Refer to the "Flashing Question Mark" symptoms mentioned in this section.
4. Boot from Apple Hardware Test (hold down the "C" key at startup) or boot from the system install CD (use Startup Manager, hold down the Option key at startup).
5. Perform a clean install with the CD that came with the computer.
6. Replace the optical drive cable.
7. Replace the optical drive.
8. Replace the logic board.

Sound Out

No sound from either internal or external speakers

1. Verify volume setting is correct in system preferences.
2. Verify the computer is not set to “mute”. Press the mute key on the Apple keyboard.
3. Reset parameter RAM. Press Command-Option-P-R during startup.
4. Test the computer with known-good headphones. Do you get sound? If yes, go on to step 4. If no, replace the main logic board.
5. Verify that the speaker cable is connected.
6. Replace the speaker assembly.
7. Replace the logic board.

No sound from the headphones

1. Verify the problem with known-good headphones.
2. Verify the computer is not set to “mute”. Press the mute key on the Apple keyboard.
3. Verify volume setting is correct in Mac OS X system preferences. If the preferences are set correctly, replace the logic board.
4. In Mac OS 9, check the Sound Control panel, Speakers tab. When headphones are connected, a headphone icon will be present. If the headphone jack is malfunctioning it may indicate that headphones are connected when none are connected. In this case, replace the logic board.

Sound In

No sound is recorded

1. Check setup of the system preferences for the microphone.
2. Check that the microphone is picking up sound by testing the audio in iMovie. Click on the Audio button. Record something. The audio bar on the screen should indicate if the microphone is working.
3. Check the microphone cable connection.
4. Replace the internal microphone.
5. Replace the main logic board.

Error Beep(s)

Computer beeps at startup.

1. RAM expansion DIMMs for the eMac must be PC133 compliant and use SDRAM devices. If the user installs a DIMM that uses EDO or SGRAM devices, the computer will beep several times when the user attempts to restart the computer.
2. Refer to “Power-On Self Test” mentioned earlier in this chapter.

Modem

No modem dial tone

1. Verify known-good analog (not digital) telephone line.
2. Verify known-good RJ-11 telephone cable.
3. Verify RJ-11 cable is not plugged into Ethernet port.
4. Inspect RJ-11 connector and modem port for pin damage.
5. Verify RJ-11 cable is firmly installed in the modem port.
6. Verify correct modem driver is installed and the correct CCL is selected. If the problem persists, reinstall system software.
7. Open the bottom housing. Verify the internal RJ-11 modem cable is connected to the modem.
8. Replace the RJ-11 cable/ jack.
9. Replace the modem.
10. Replace the logic board.

USB Printing Problems

eMac cannot print to attached known-good printer.

1. Verify that the printer is Macintosh compatible.
2. Verify that you have setup the printer correctly in OS X.
3. Refer to Knowledge Base article 106714, Mac OS X: How to Print
4. Reinstall the printer driver.
5. Switch the printer to another USB port.
6. Replace the printer interface cable.
7. System software is corrupted. Reinstall the system software.
8. Replace the logic board.



Upgrades
eMac



Memory

Tools

- Phillips #2 screwdriver.

Part Location

Note: The memory is located behind the user access panel shown below.



Procedure

1. Save open documents and quit all open applications.
2. Turn the computer off by choosing Shut down from the Special menu (Mac OS 9) or by choosing Shut down from the Apple menu (OS X).
3. Unplug all cables, except the power cord, from the computer. **Warning:** If the internal modem is connected to a telephone line, disconnect the telephone line from the internal modem port before you open the user access door. This prevent electric shock.



4. Place a soft towel or ESD mat on the desk or surface.

5. Position the computer so the screen is facing down on the cloth or ESD mat.
6. Remove the screw on the user access panel.



7. Touch a metal surface inside the computer. Then unplug the power cord. This helps



protect the computer from damage caused by electrostatic discharge. **Important:** Always do this before you touch any parts, or install any components, inside the computer. to avoid generating static electricity, do not walk around the room until you have finished installing the memory and closed the computer.

8. Insert a memory module into one of the two memory slots, whichever is open.



9. Push the ejectors on the memory slot outward and down so they are in the open position. The module is designed to fit into the slot only one way. Be sure to align the notches on the module with the small notches inside the slot.



10. Push down on the memory until it snaps into place. The ejectors will automatically close.

-
11. Replace the user access panel.
 12. Gently turn the computer right side up.
 13. Reconnect the cables you disconnected from the computer.
 14. Press the Power button on the side of the computer to turn it on. **Note:** to verify that your computer detects the additional memory, choose the Apple system Profiler from the Apple menu.
 15. Reconnect all cables and restart the computer.

Warning: Never turn on the computer unless all of its internal and external parts are in place and it is closed. Operating the computer when it is open or missing parts can damage your computer or cause injury.



AirPort Card

Tools

- Phillips #2 screwdriver

Part Location



1. Save open documents and quit open applications.
2. If you have the keyboard, press the Media Eject key on the keyboard to open the access door. **Note:** If you don't have access to the customer's keyboard, carefully pry the door open with a flatblade screwdriver. Be careful not to scratch the door or bezel.



3. The drive tray will open (if you are using the keyboard).



4. Turn the computer off by choosing Shut down from the Special menu (Mac OS 9) or by choosing Shut down from the Apple menu (OS X).
5. Loosen the captive screws on the AirPort access panel using a Phillips screwdriver.



6. Remove the panel and unhook the antenna from the panel.



7. Insert the AirPort Card partially into the slot, with the logo facing down, then connect the antenna firmly to the card.

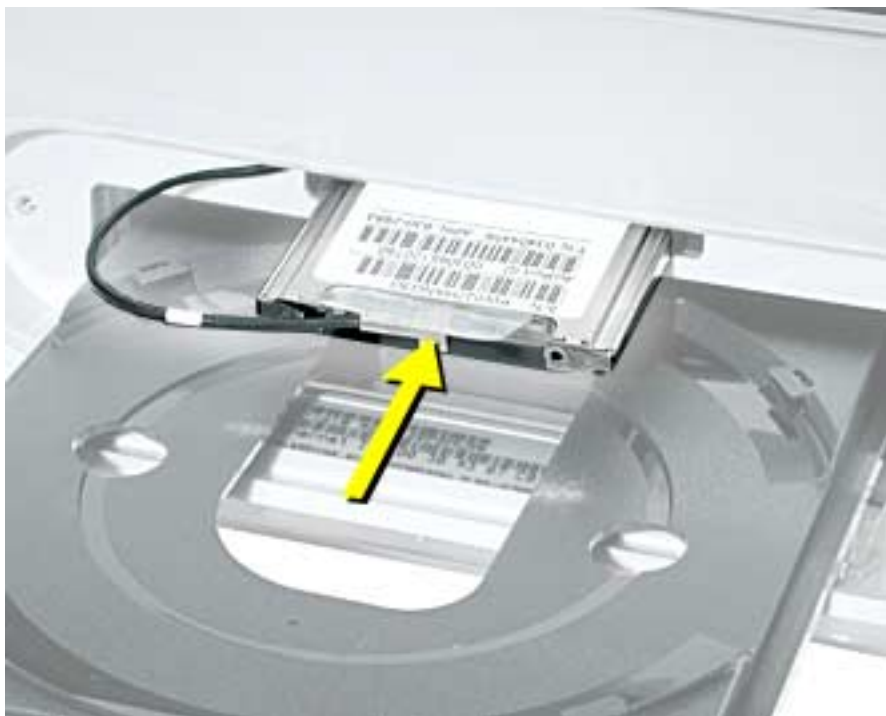

8. Push the AirPort Card firmly all the way into the slot and tuck the antenna into the

computer.



9. Tuck the tab on the AirPort Card down into the computer.



10. Replace the AirPort access panel and tighten the screws.



11. Press the Power button on the computer to turn it on. **Warning:** Never turn on the computer unless all of its internal and extra parts are in place. Operating the computer when it is open or missing parts can be dangerous and could damage your computer.



Computer Stand

Tools

- 4 mm hex wrench: the hex wrench is supplied with the stand or available from Apple (part 077-1005).

Part Location



-
1. Save open documents and quit all open applications.
 2. Turn the computer off by choosing Shut down from the Special menu (Mac OS 9) or by choosing Shut down from the Apple menu (OS X).
 3. Unplug all cables.
 4. Place a soft towel or cloth on the desk or surface.
 5. Turn the computer over onto the cloth.



6. The stand attaches to the locations circled below.



7. Remove the screw located between the computer's feet.



8. Position the stand on top of the screw holes.



9. **Note:** The stand slides back and forth. To attach the first screw, slide the stand toward the back of the computer.



10. Tighten the first screw.

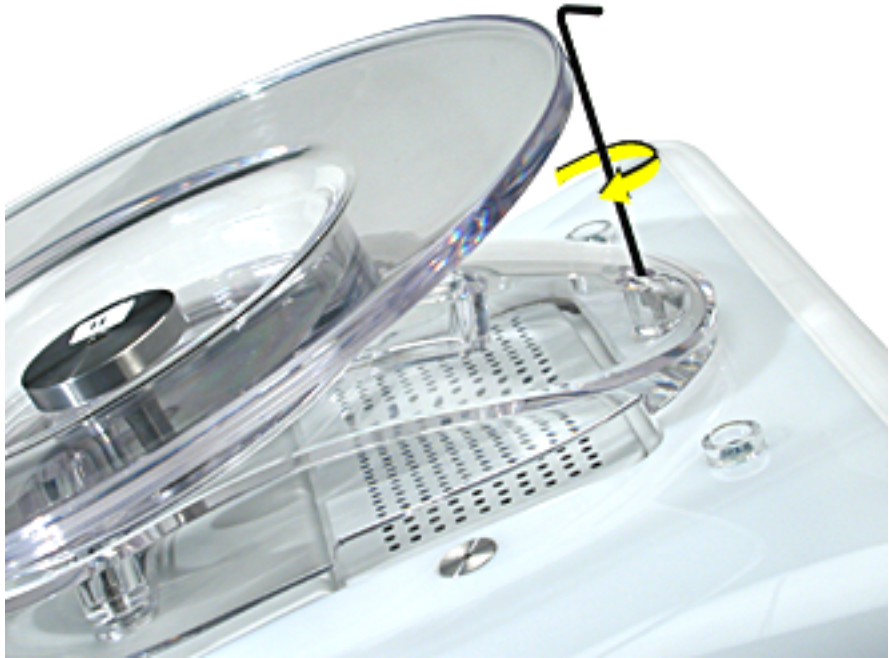

11. Slide the stand forward to access the two rear screws.



12. Tighten the screw on the left.



13. Tighten the screw on the right.



14. Carefully turn the computer over. The computer now swivels horizontally and vertically.



eMac: Digital Module (Logic, Drives, Carriers)

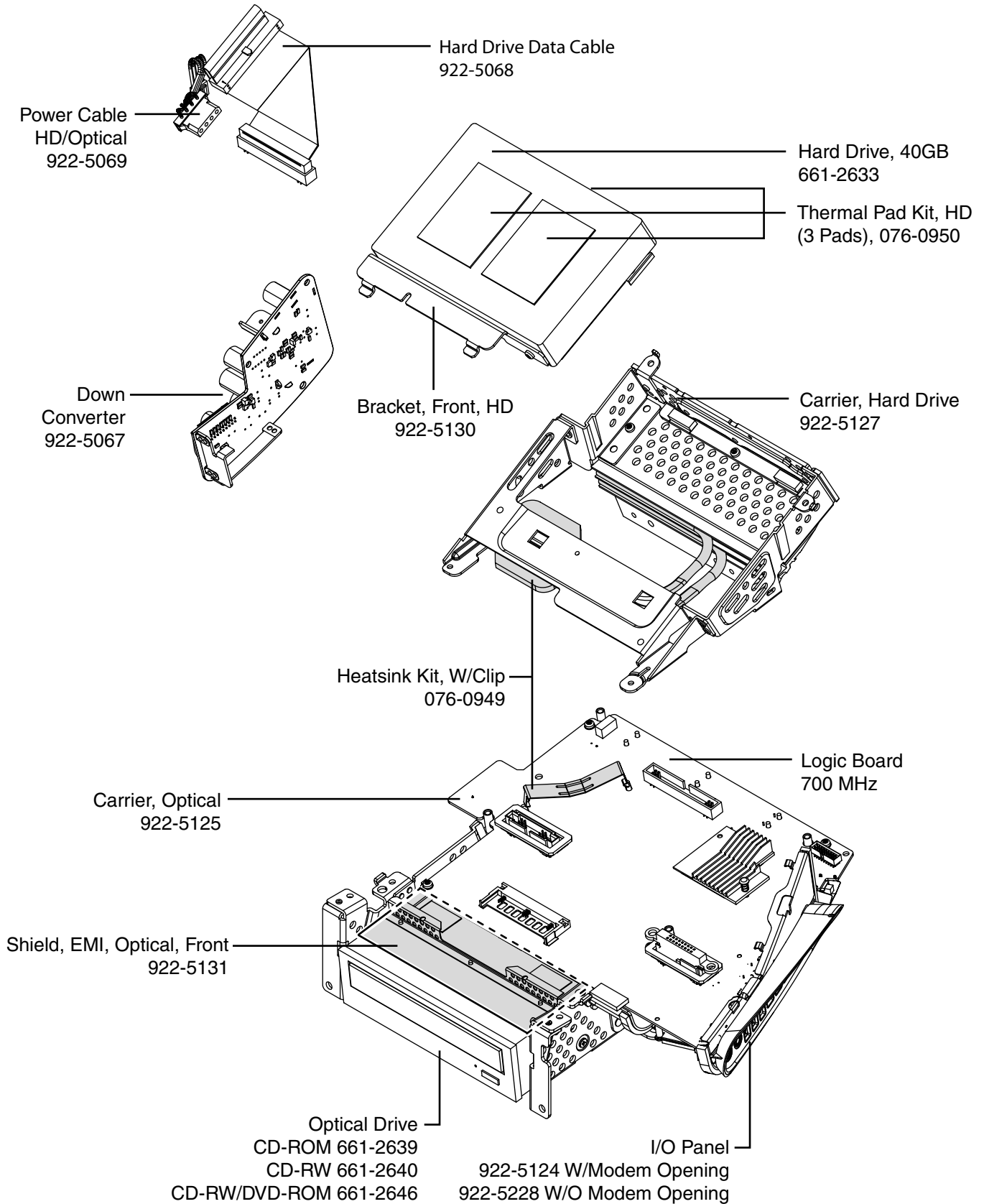

eMac: Display, Digital Module, Faraday

Display / Analog Assembly
 661-2634 Northern Hem.
 661-2635 Southern Hem.

Hard Drive Carrier
 922-5127

Fan Assembly
 922-5083

Faraday Cage
 922-5084

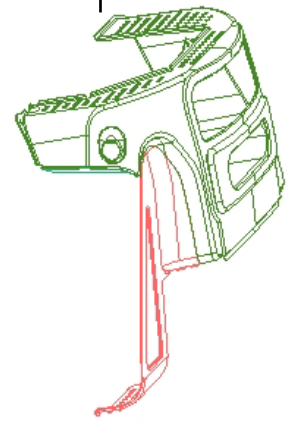
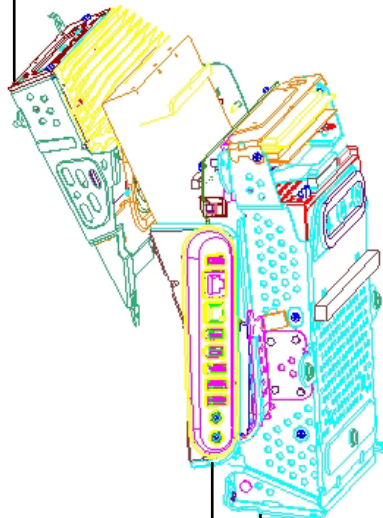
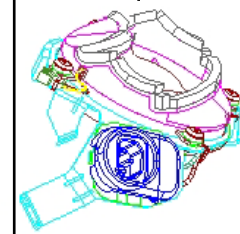
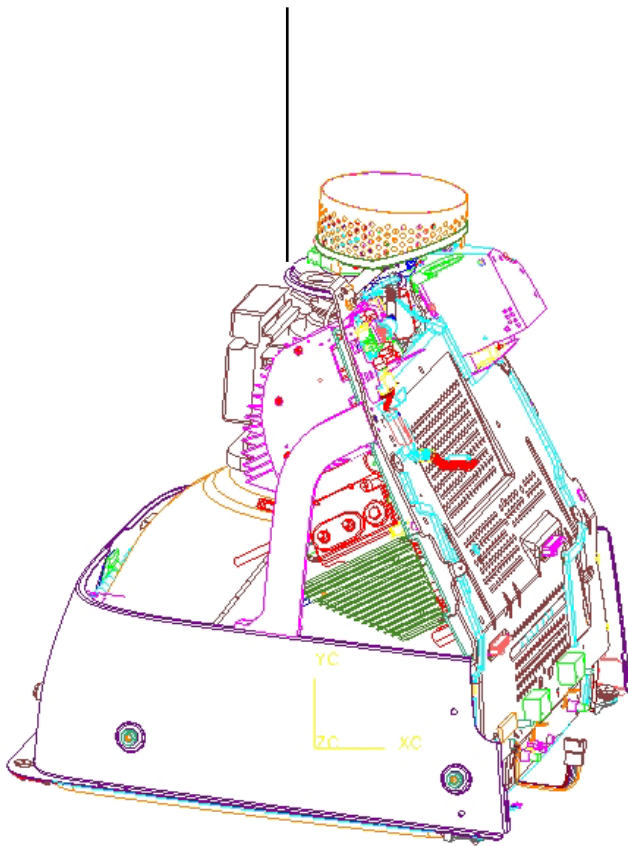

Antenna
 922-5082

AirPort Card Guide
 922-5126

I/O Panel
 922-5124

Optical Carrier
 922-5125

W/Modem Opening
 922-5228
 W/Out Modem Opening

eMac: Digital Module (Logic, Optical, Carriers)

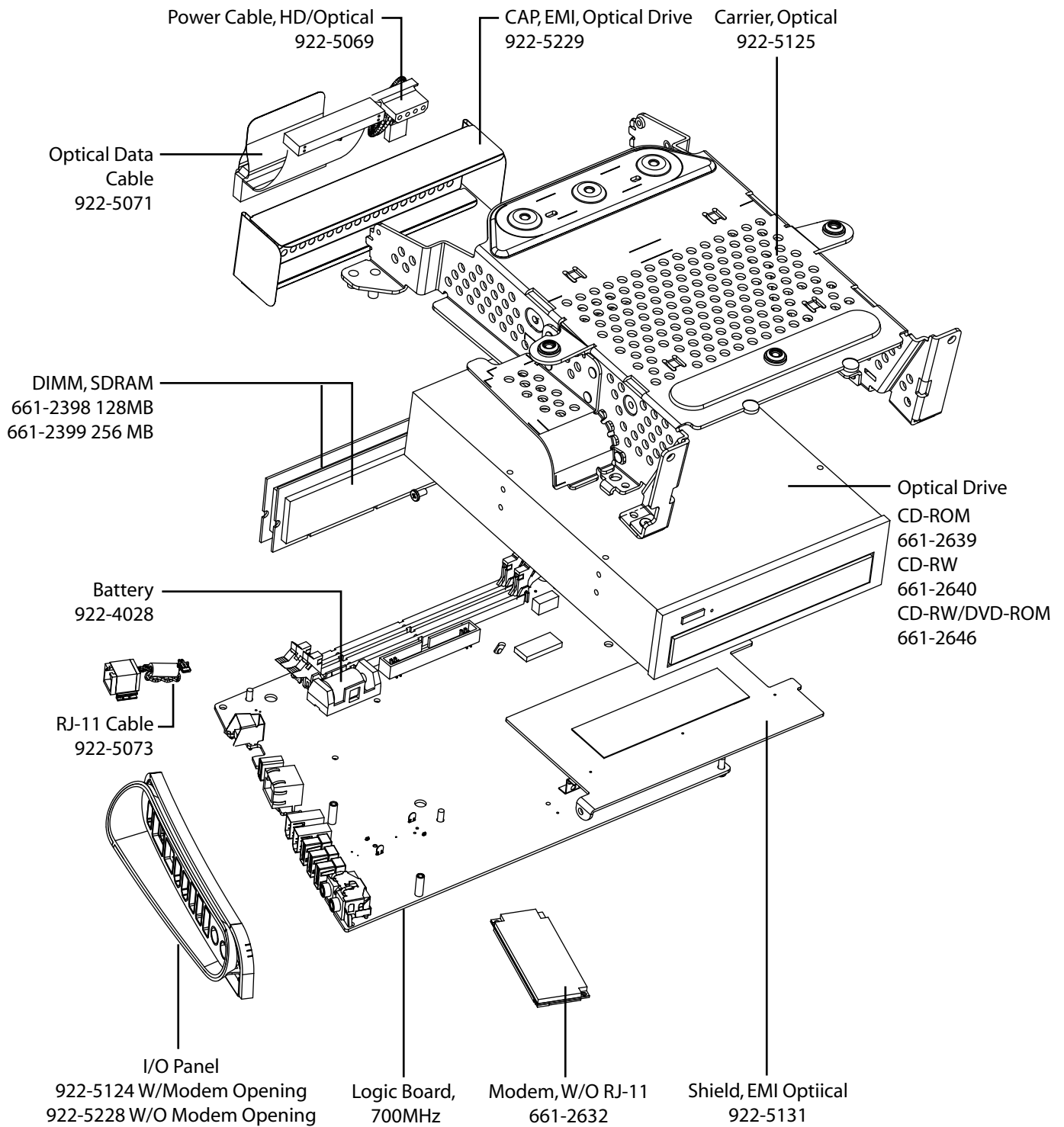

eMac: Display/Analog, Bezel, Rear Housing

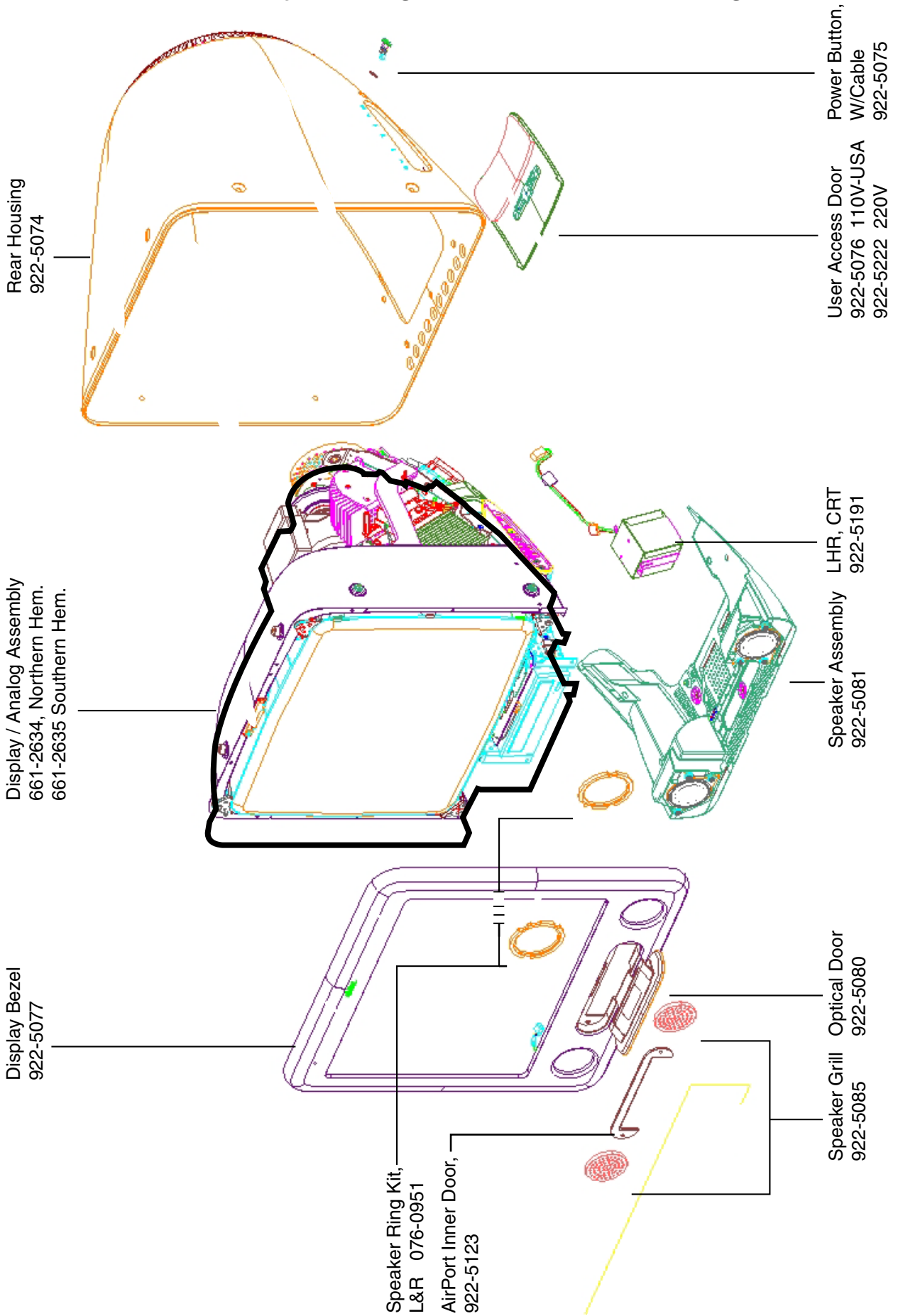

eMac Screw Matrix

Note: H/S = Heatsink
DP = Divider Panel

922-5258 Phillips #2



AirPort Card Guide to DP (2)
Antenna PCB to DP (1)

922-5219 Phillips #2



Antenna Bracket to Top of CRT
(1)

922-5134 Phillips #2



User Access Door (1)
Feet to Rear Housing (2)

922-5263 Phillips # (2)



Bezel to CRT Frame (8)

922-5259 Hex 2.5mm



Rear Housing (6)

922-5260 Hex 2.5mm



Rear Housing to CD Carrier (3)

922-5264 Phillips #2



CD Carrier to Bezel (2)

922-5136 Phillips #2



HD Carrier to DP (2)
CD Carrier to DP (4)

922-5133 Phillips #2



Down Connector (1)

922-5135 Phillips #2



LHR Coil to DP (1)
Fan Bracket (4)
CD Carrier to Bracket

Faraday Cage to DP (5)
Down Converter to CD Carrier (1)
H/S to HD Carrier (3)
HD Carrier to H/S Extension Rear (2)
I/O to DP (1)
I/O to Logic Board (2)
AC Socket to Fan Bracket (2)
Rear Support (2)

922-5251 Phillips #2



HD to Bracket Front HD
Carrier (2)
HD to Thermal Barrier
Bracket (2)

922-5252 Phillips #2



Hard Drive to H/S Extension
Rear (3)

922-5139 Phillips #2



CD Carrier to HD Carrier (4)

922-5253 Phillips #2

H/S, CPU to HD Carrier (2)
H/S, CPU & H/S Ext. Rear (1)

922-5254 Jeweler's #1



Modem to Logic (2)

922-5137 Phillips #2



CD Carrier to CD (4)

922-5256 Phillips #2

Bracket, Fan (4)

922-5261 Phillips #2

Bezel to Pwr. Ind. Board (1)
Bezel to CD Door Hinge (2)

922-5261 Phillips #2

Bezel to Pwr. Ind. Board (1)
Bezel to CD Door Hinge (2)

922-5257 Phillips #2

AC Socket to Ground (1)

922-5262 Phillips #2

Inner AirPort Door,
Fixed Screw (2)

922-5255 Phillips #2

MLB to CD Carrier (4)