

eMac (ATI Graphics)

Updated 15 July 2003





Take Apart
eMac (ATI Graphics)





Tools

The following tools are recommended for the take apart procedures.

- 2.5 mm hex (for rear housing)
- Nylon probe tools (922-5065)
- Phillips #1 screwdriver
- Phillips #2 screwdriver
- Jeweler's screwdriver set
- Needlenose pliers
- ESD wriststrap and mat
- CRT discharge tool

Note: Do not use a power driver on the rear housing screws.



CRT Neck/Display/Analog Assembly Handling Information

Handling

Important: It is imperative that proper handling and packaging guidelines be followed when working with the display/analog assembly.

Do NOT lift, handle, bump, or manipulate the CRT neck/neck board (see arrows below) on the Display/Analog assembly. Modules damaged by mishandling are NOT covered by Apple Warranty. Apple Authorized Service Providers can be liable for broken CRT necks due to improper handling.

Caution: The metal chassis has sharp edges, you may want to wear gloves when handling the assembly. Lift the assembly from the metal chassis; never lift the assembly from the neck. I

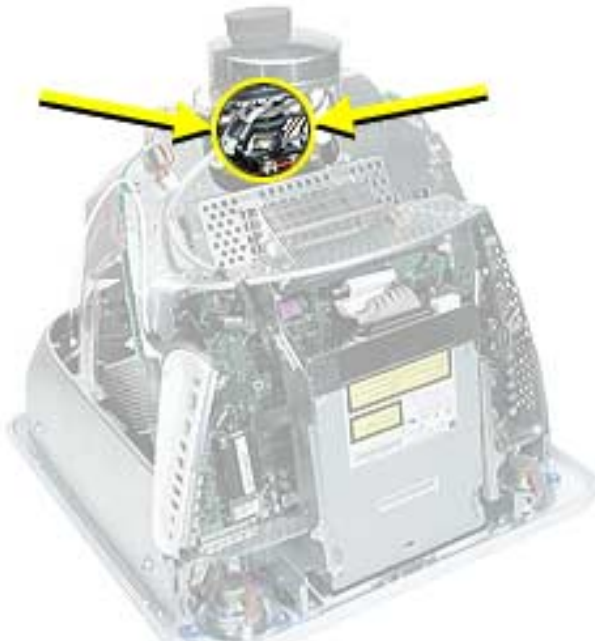

Packing a Defective Display/Analog Assembly

The packing procedure is included with the replacement display/analog assembly. Incorrect packaging can result in damaged eMac (ATI Graphics) displays. Please read and follow the directions enclosed in the shipping box of the new display prior to packaging the defective assembly. AASPs can be liable for broken CRT necks due to improper packing and handling.



Rear Housing

Tools

- 2.5 mm hex (for the rear housing)
- Phillips #2 screwdriver

Part Location



Preliminary Steps

Before you begin, do the following:

- Place the computer face down on an ESD mat.

Procedure

1. Remove ten screws. Seven screws on the rear housing, one screw on the user access door (requires Phillips screwdriver), and two screws for the feet (requires Phillips screwdriver).



2. Gently lift the rear housing up about four inches.



3. Disconnect the power button cable located on the inside the rear housing.



4. Lift the rear housing off the computer.



User Access Door

Tools

This procedure requires the following tools:

- Phillips #2 screwdriver

Part Location



Preliminary Steps

Before you begin, do the following:

- Place the computer face down on an ESD mat.

Procedure

1. Remove the screw on the user access door (shown below).
2. Gently remove the access door.





Feet

Tools

This procedure requires the following tools:

- Phillips #2 screwdriver

Part Location



Preliminary Steps

Before you begin, do the following:

- Place the computer face down on an ESD mat.

Procedure

1. Remove the two foot screws. Set the plastic feet aside.





Power Button

Tools

- Needlenose pliers

Note: Follow the Replacement Note procedure (step 2) only if you are replacing a defective power button.

Part Location



Preliminary Steps

Before you begin, do the following:

- Place the computer face down on an ESD mat.
- Remove the user access panel.
- Remove the feet.
- Remove the rear housing.

Procedure

1. Disconnect the power button cable from the power button located inside the rear housing.



2. Lift the rear housing off the bezel. **Replacement Note:** Refer to the topic on the next page, “Power Button Cable Check” before replacing the rear housing.



Power Button Cable Check

1. Check that the power button cable is drawn tight before you attach the other end of the cable to the power button (located inside the rear housing).

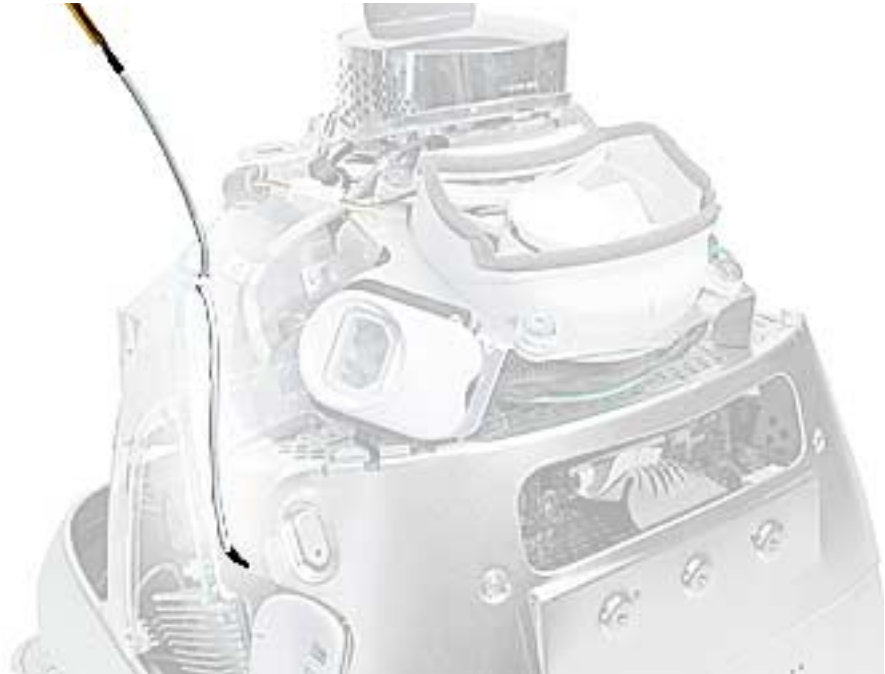

2. Also, check that the cable is tucked under the chassis tab (as shown) and that the black mark on the cable lines up with the chassis (circled below).



Power Button Replacement

1. Continue with this procedure only if you are replacing a defective power button. With a needlenose pliers, push the power button through the retaining ring. The power button will pop off rear housing and the retaining ring may get stuck on the pliers.

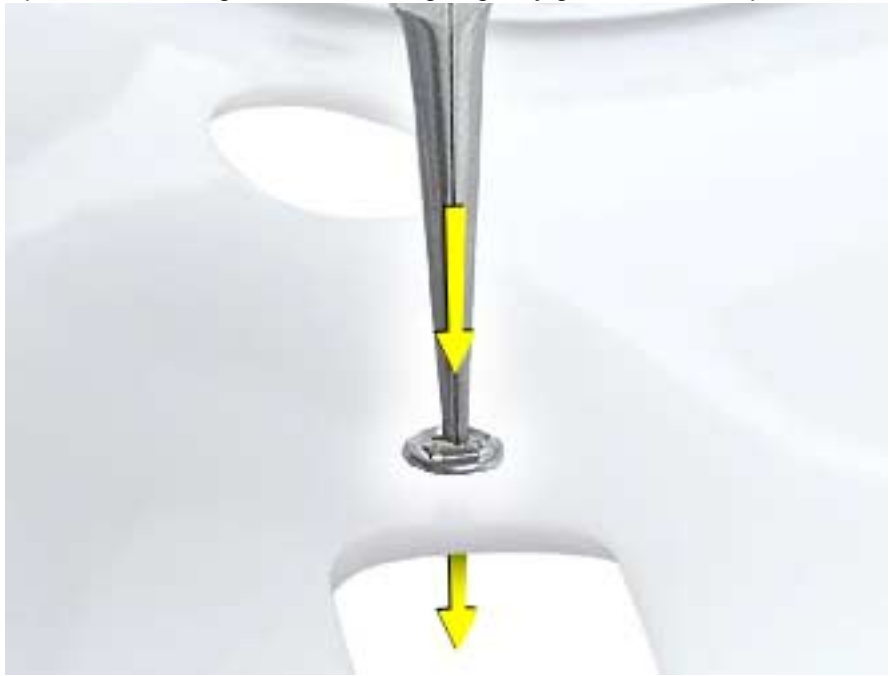

2. Obtain the new power button and peel the sticky backing off the power button. Position the power button into the hole on the rear housing (as shown below). **Note:** The picture below is looking at the power button from the inside of the rear housing.

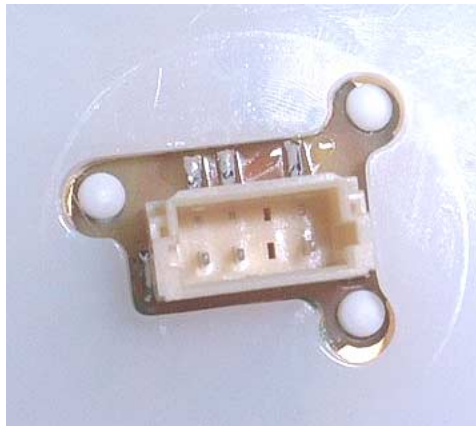

3. Place the retaining ring over the power button connector and press down firmly.



CRT Discharge

Warning: This product contains high voltage and a high-vacuum picture tube. To prevent injury, always review the Service Foundations: CRT Displays course for safety information. It can be found at: http://service.info.apple.com/service_training/training.html. Click on Desktop Certification Courses and select the Service Foundations: CRT Displays link.

Warning: Never use a grounding wriststrap until after discharging the CRT and setting up an ongoing ground connection.

Safety Guidelines:

Whenever the rear housing of the computer is removed and before replacing a module, you must

1. Discharge the CRT (shown below) and remove the anode cap.



2. Establish an ongoing ground by using a cable with alligator clips at both ends. Connect one end to the anode aperture, and connect the other end to the metal CRT frame (as shown below).
3. With the CRT discharged and the ongoing ground in place wear a grounding wriststrap to prevent equipment damage from static electricity.



Speakers

Tools

This procedure requires the following tools:

- Phillips #2 screwdriver

Part Location



Preliminary Steps

Before you begin, do the following:

- Place the computer face down on an ESD mat.
- Remove the user access door.
- Remove the feet.
- Remove the rear housing.
- Discharge the CRT.

Procedure

1. Remove the left and right speaker screws (circled in the top photos). There are three screws per speaker.
2. Disconnect the two spade connectors (see rectangles in the top photos) on each speaker.

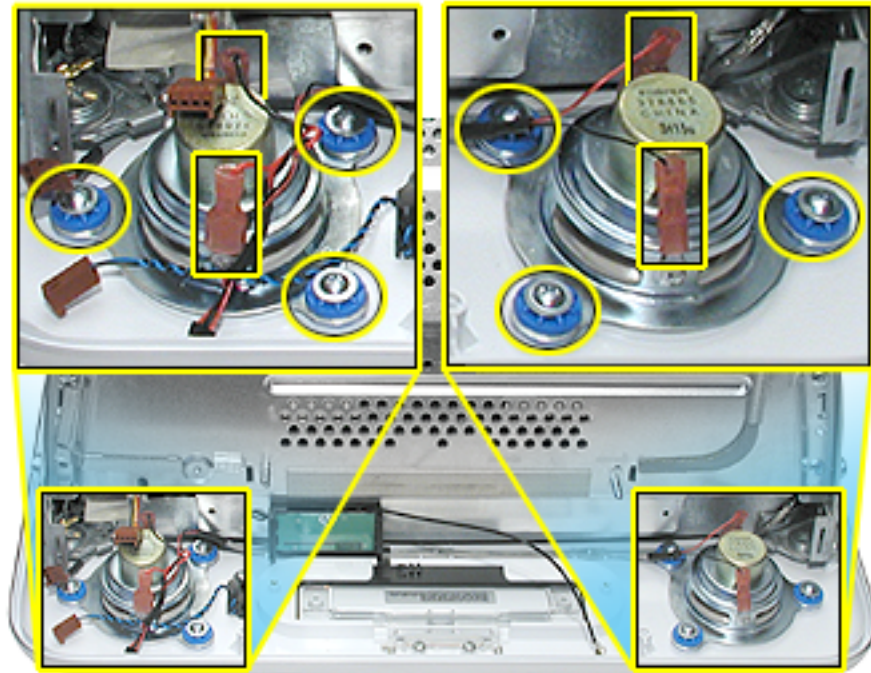

3. Lift the speakers out of the front bezel.



Fan

Tools

This procedure requires the following tools:

- Phillips #2

Part Location



Preliminary Steps

Before you begin, do the following:

- Place the computer face down on an ESD mat.
- Remove the user access door.
- Remove the feet.
- Remove the rear housing.
- Discharge the CRT.

Procedure

1. On the left side of the fan, disconnect the fan cable and remove the two screws (circled).

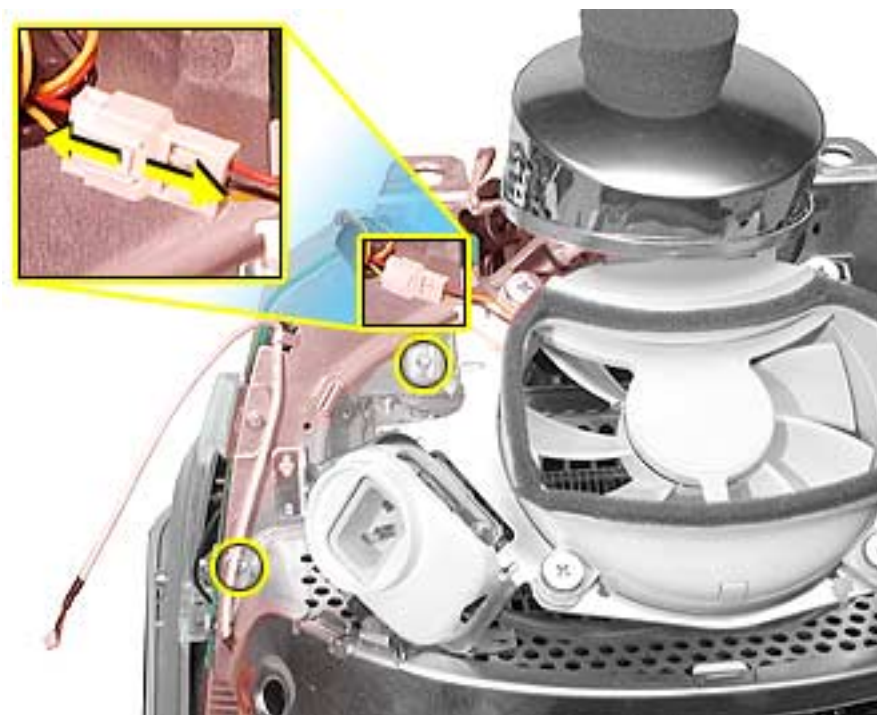

2. On the right side of the fan, remove three screws (the green cable goes to the ground screw). **Replacement Note:** The screw circled on the top left is a self-tapping screw, and the screw on the bottom left is a fine thread screw.

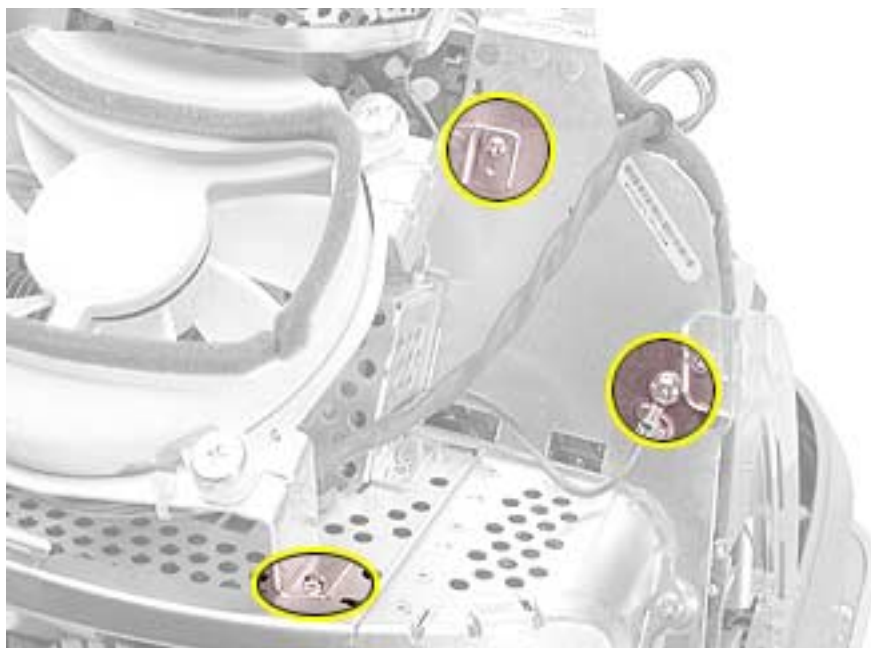

3. Wiggle the fan cable up and out of the groove in the chassis and then disconnect the fan connector from the board.



4. To remove the fan, turn the computer so the fan is facing you. Grab onto the fan near the AC plug and the bottom right corner of the fan. Gently pull the fan toward you and away from the chassis. Be very careful of the CRT neck.



Faraday Plate

Tools

This procedure requires the following tools:

- Phillips #2

Part Location



Preliminary Steps

- Place the computer face down on an ESD mat.
- Remove the user access door.
- Remove the feet.
- Remove the rear housing.
- Discharge the CRT.

Procedure

1. Remove the four screws on the Faraday plate. **Replacement Note:** Note the position of the gray cable (see red arrow) on the top left side of the Faraday plate. Be careful the cable doesn't get pinched when the Faraday plate is replaced.

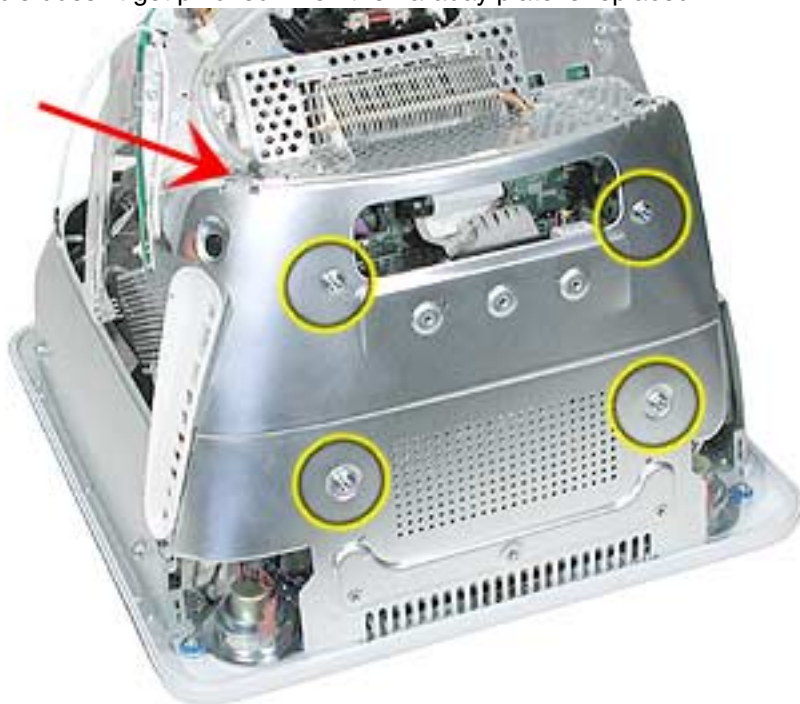

2. Gently pry the top half of the Faraday plate away from the chassis in the direction of the arrows. **Note:** The gray cable (on left) rests in a groove under the Faraday plate.

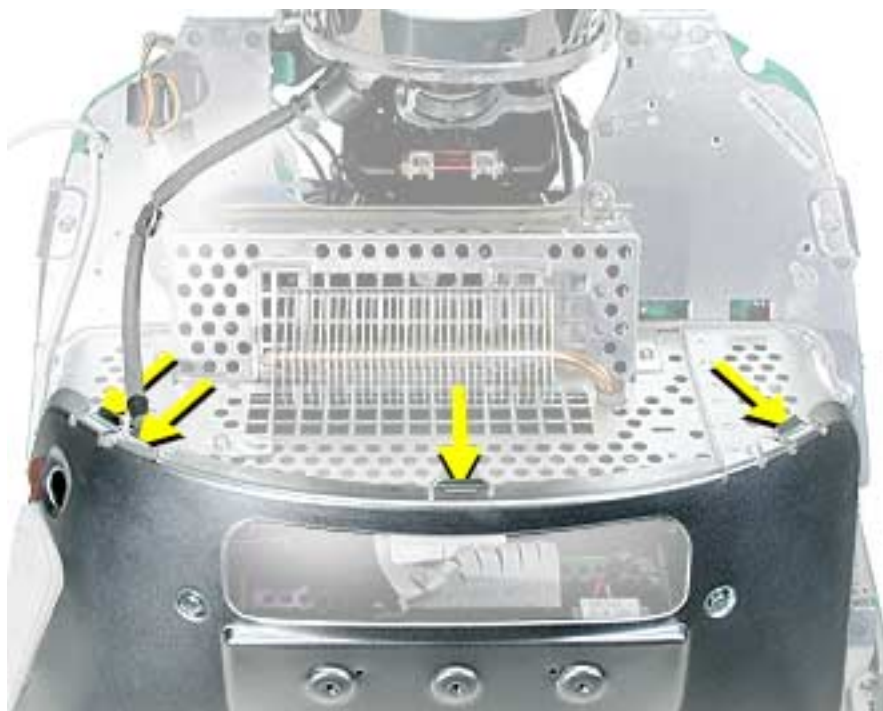

3. Pull the Faraday plate back (#1) and then push it down (#2) to unhook the metal tabs on the Faraday plate from the cutouts (see graphic on the next page) in the chassis.

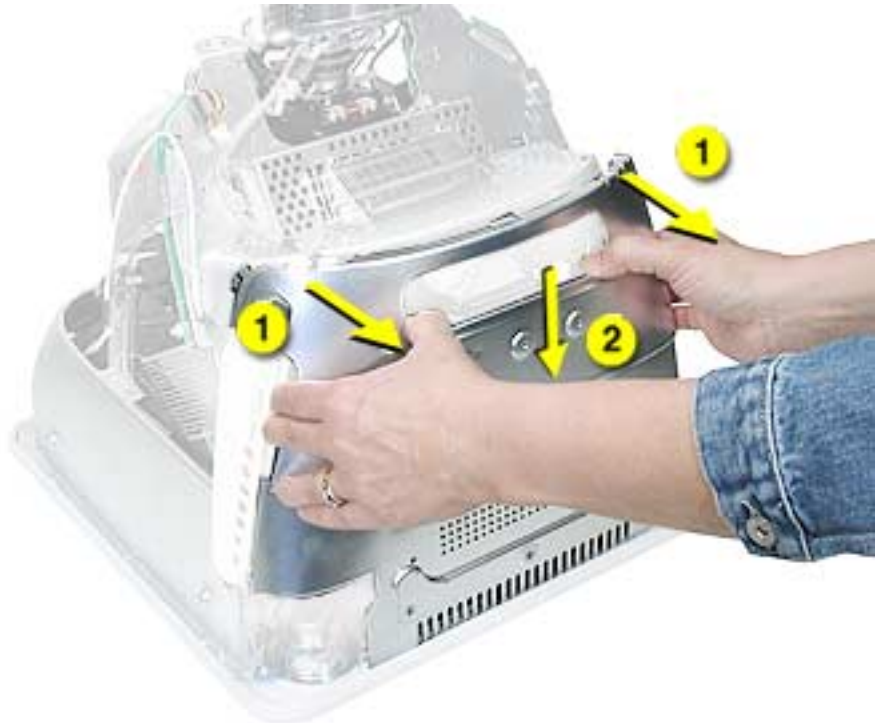

4. Continue to pull the Faraday plate back (#1) to unhook the tabs from the chassis. Pull the Faraday plate up (#2) to remove it from the chassis.

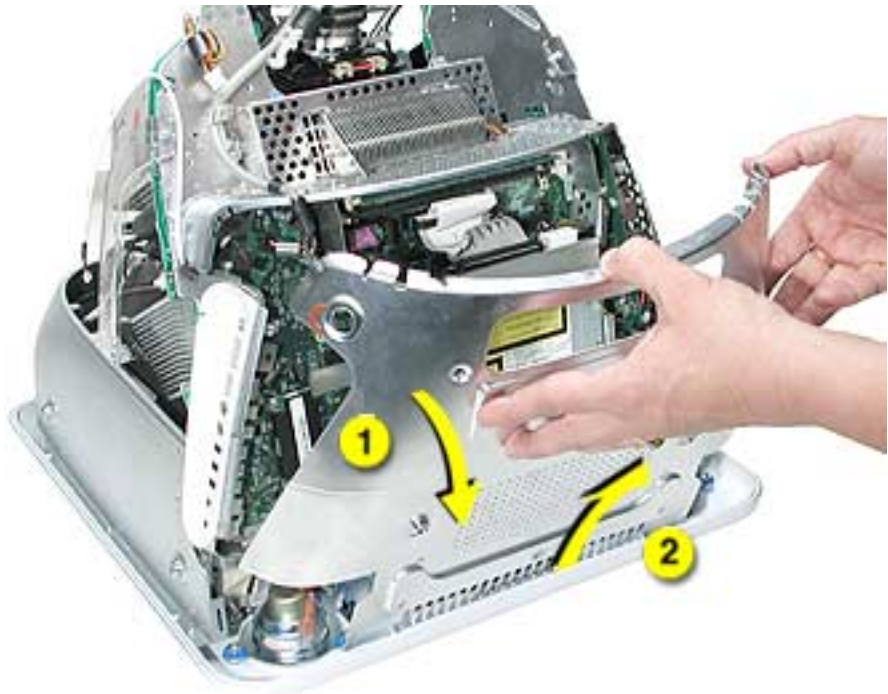

Faraday Replacement

1. Looking from the top down, line up the metal tabs with the cutouts in the chassis (circled on the right and left) and the slots on the Faraday plate with the white plastic guides on the bezel (circled on the right and left sides of the optical drive).
2. Raise the Faraday plate up and attach it to the frame on the digital assembly. Be careful that the gray cable (shown in step 2 on the previous page) does not get pinched in the Faraday plate.

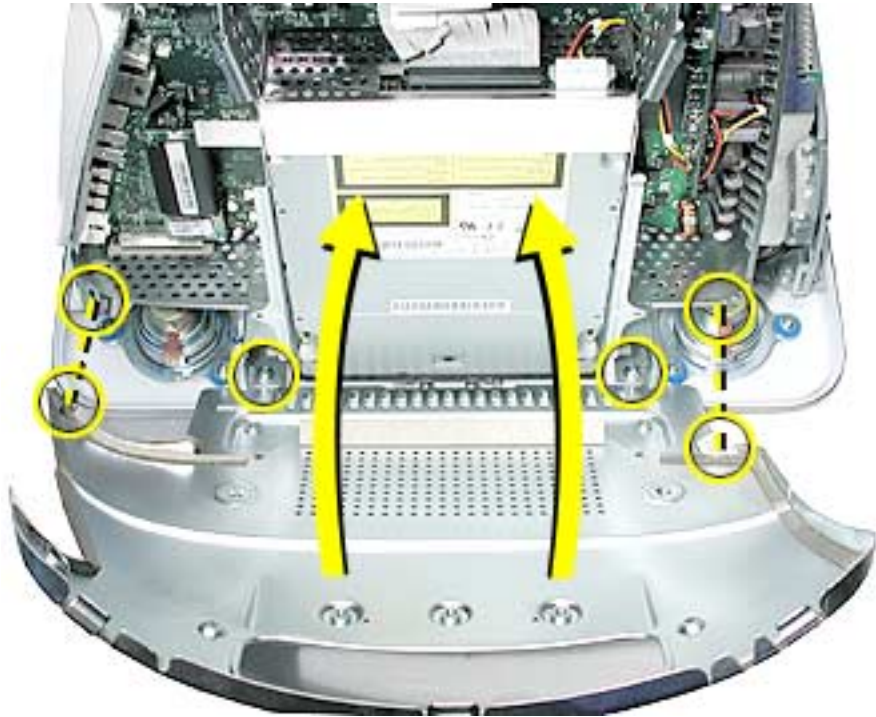



Optical Drive

Tools

This procedure requires the following tools:

- Phillips #2 screwdriver

Part Location



Preliminary Steps

Before you begin, do the following:

- Place the computer face down on an ESD mat.
- Remove the user access door.
- Remove the feet.
- Remove the rear housing.
- Discharge the CRT.
- Remove the Faraday plate.

Procedure

1. Disconnect the data cable and the power cable at the top of the optical drive.

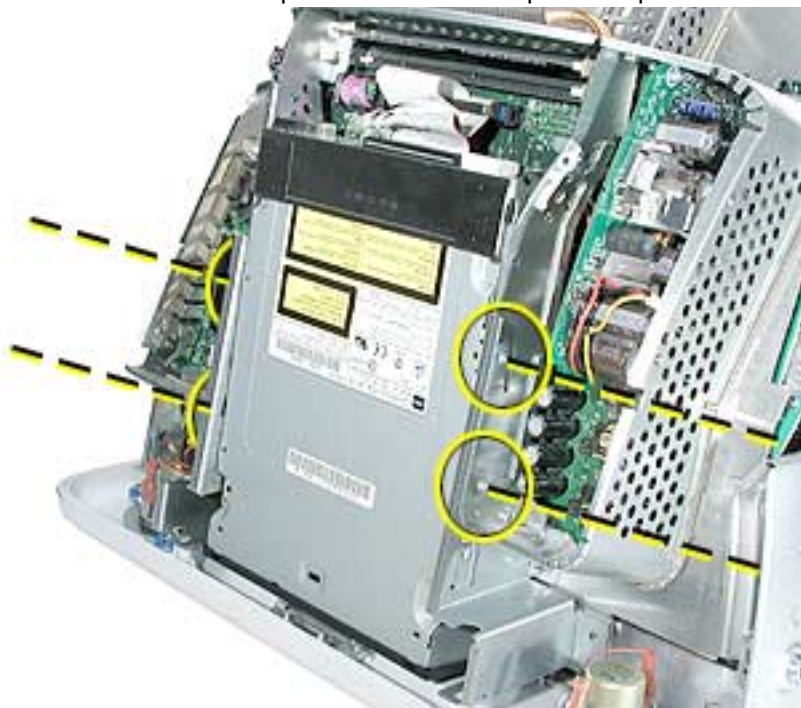

2. Remove the four screws connecting the optical drive to the chassis.

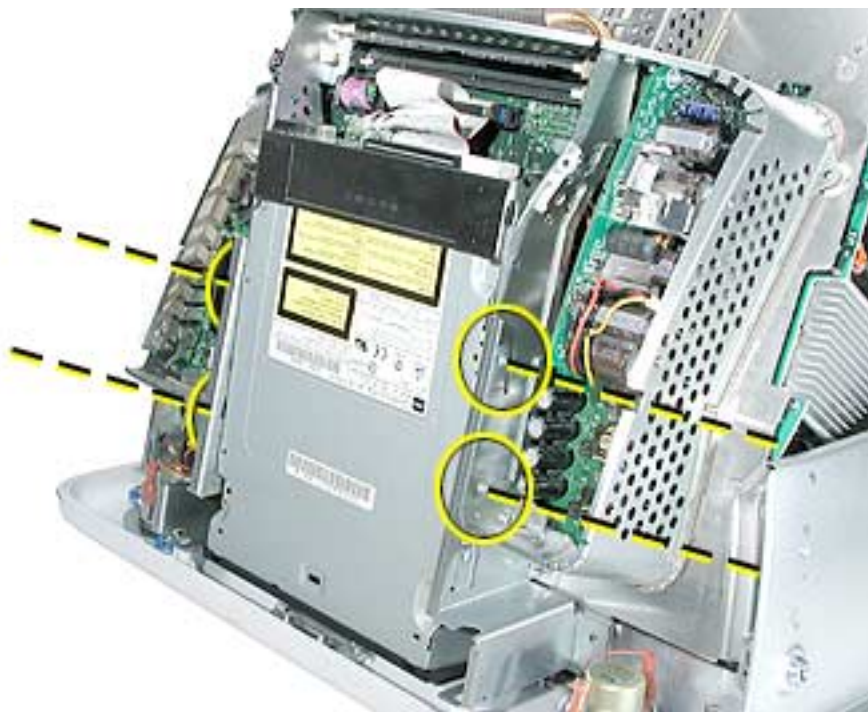

3. Holding the optical drive by the top or bottom end, tilt the optical drive out of the chassis. **Replacement Note:** Remove the EMI shield on the end of the optical drive. Place the EMI shield on the replacement drive.



Digital Assembly

Tools

This procedure requires the following tools:

- Phillips #2

Part Location



Preliminary Steps

Before you begin, do the following:

- Place the computer face down on an ESD mat
- Remove the user access door
- Remove the feet
- Remove the rear housing
- Discharge the CRT

-
- Remove the fan
 - Remove the Faraday plate
 - Remove the AirPort Extreme Card (if present)

Procedure

1. With the back of the computer facing you, remove the three screws near the top of the digital assembly.

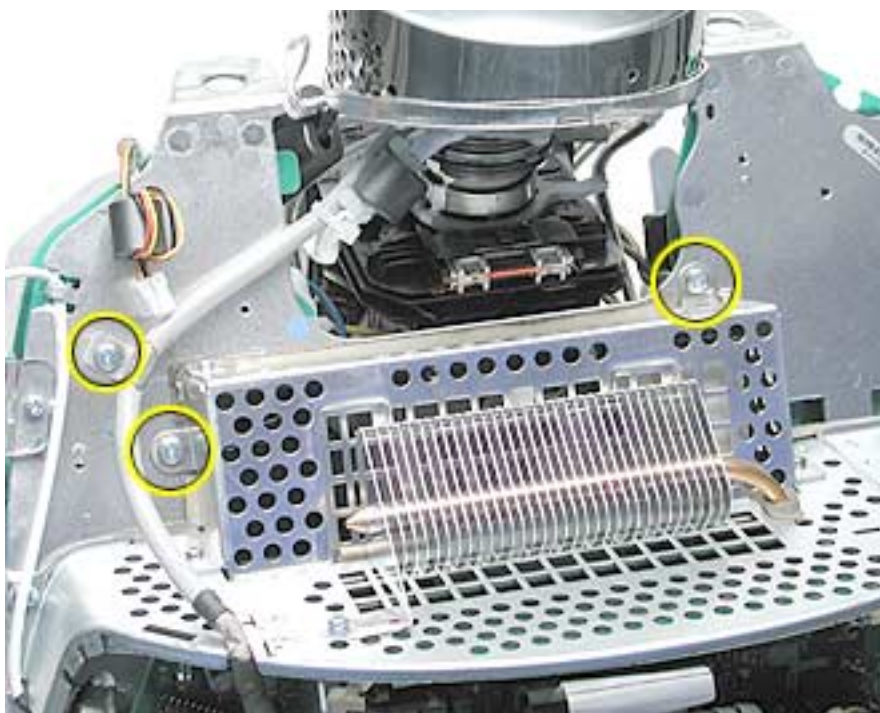

2. Disconnect the power button cable and the video cable on the top left side of the digital assembly.



3. Remove two screws; one on each side of the digital assembly.

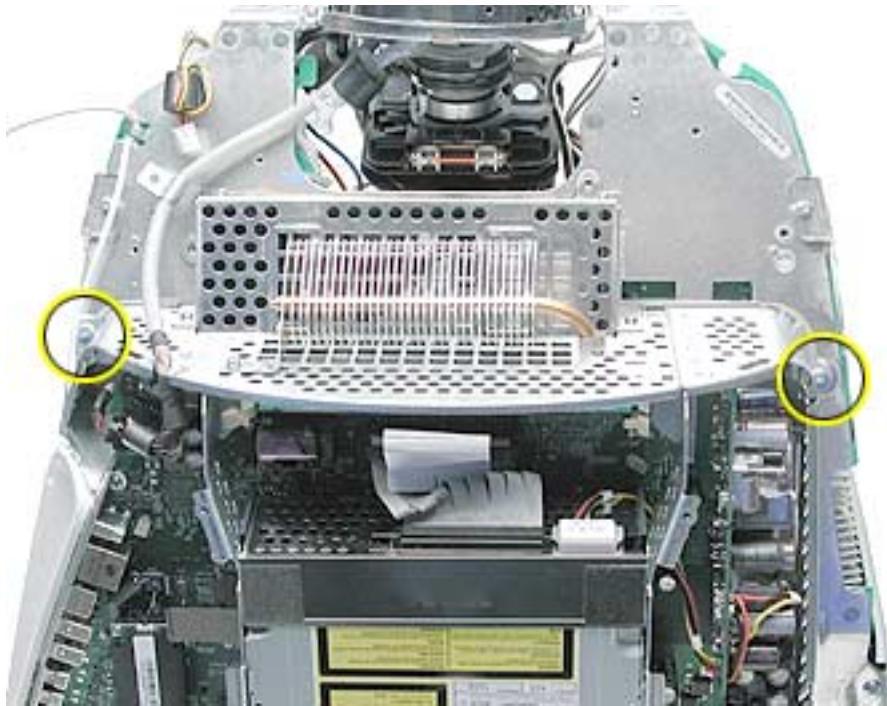

4. On the bottom left side of the digital assembly, remove three screws. **Note:** The two screws (at the top of this photo) are the same type screw; the third screw is a larger, self-tapping screw that attaches to the front bezel.



5. Disconnect the four cable connectors on the bottom left side of the assembly. From left to right the connectors are: microphone, fan, LED, and speakers.

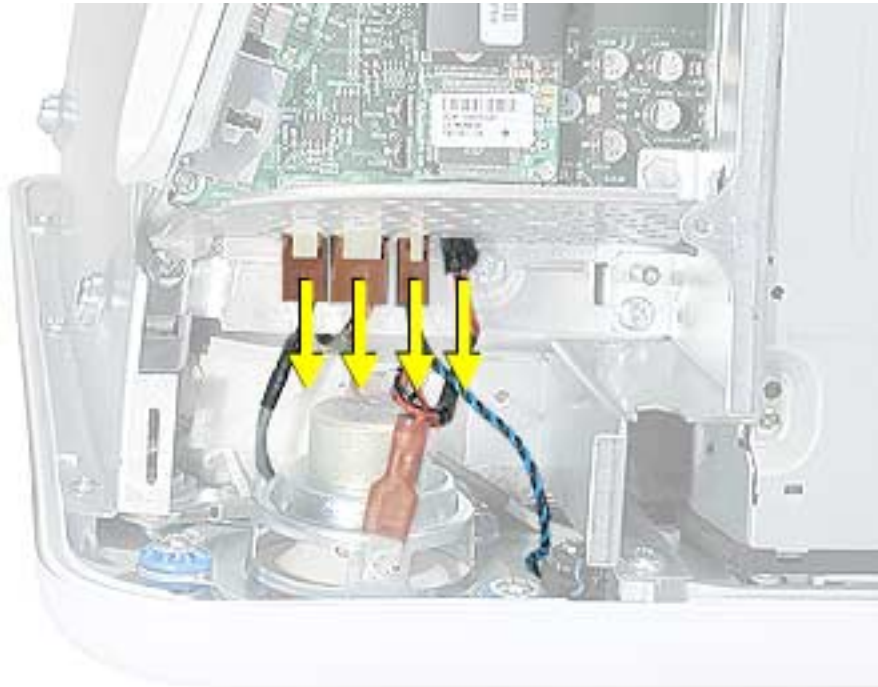

6. Remove the two screws on the bottom right side of the assembly. **Note:** The screw that attaches to the plastic bezel is a larger, self-tapping screw.

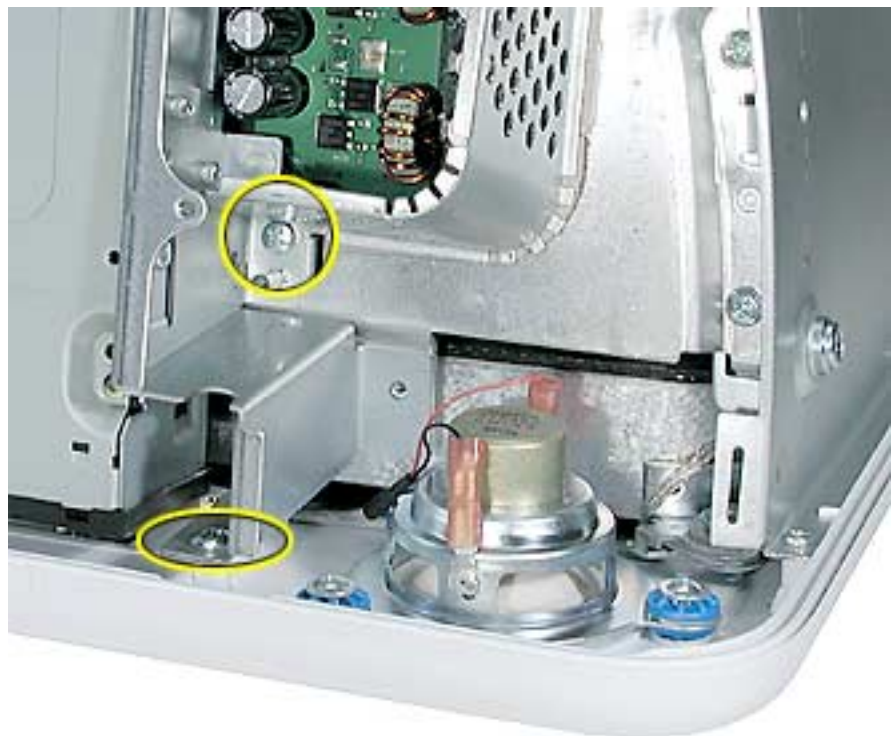

7. Hold the digital assembly by the sides and pull the assembly straight back. The digital assembly disconnects from the blind mate connector (circled) on the chassis. Set the digital assembly aside.

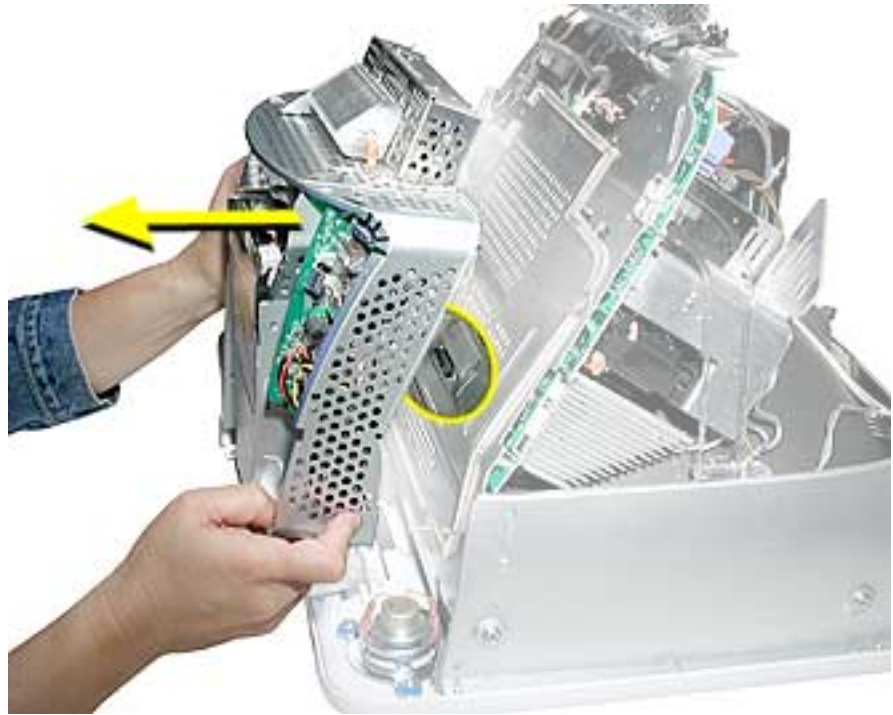



Hard Drive

Tools

This procedure requires the following tools:

- Phillips #2
- Phillips #1

Part Location



Preliminary Steps

Before you begin, do the following:

- Place the computer face down on an ESD mat.
- Remove the user access door.
- Remove the feet.
- Remove the rear housing.
- Discharge the CRT.

-
- Remove the fan.
 - Remove the Faraday plate.
 - Remove the digital assembly.

Procedure

1. Remove the four screws along the back of the metal chassis. **Note:** The two outer screws are fine thread screws.

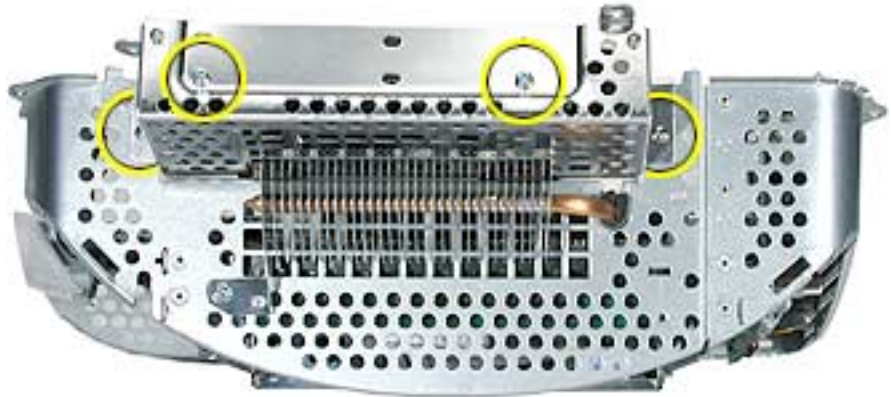

2. Gently unhook (see circle) and lift the hard drive carrier up and off the chassis. Flip the drive carrier over to access the data and power cables.

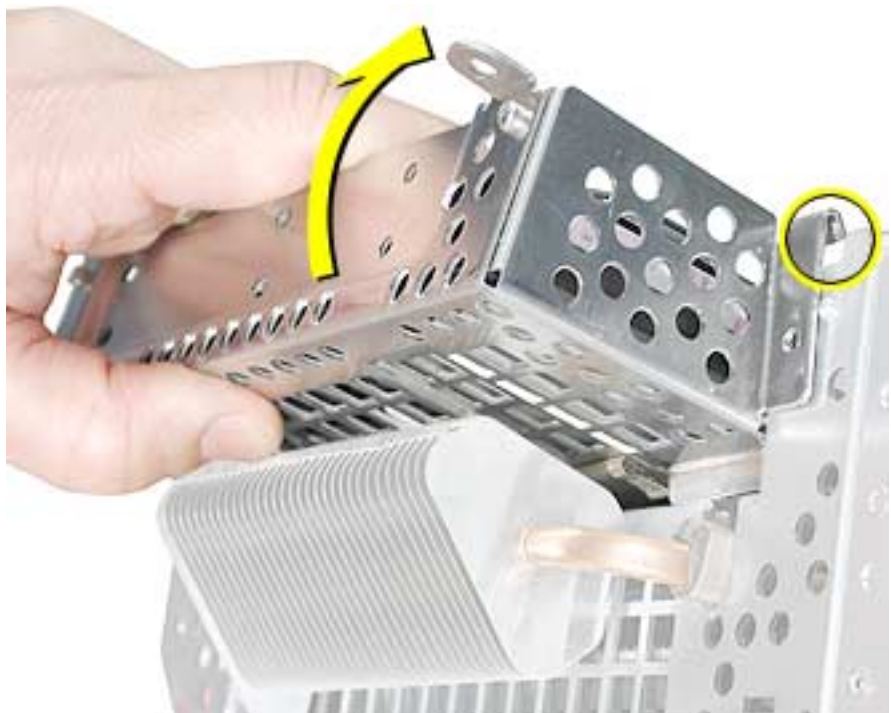

3. With the drive carrier flipped over (#1), disconnect the data cable (#2) and the power cable (#3) from the hard drive.

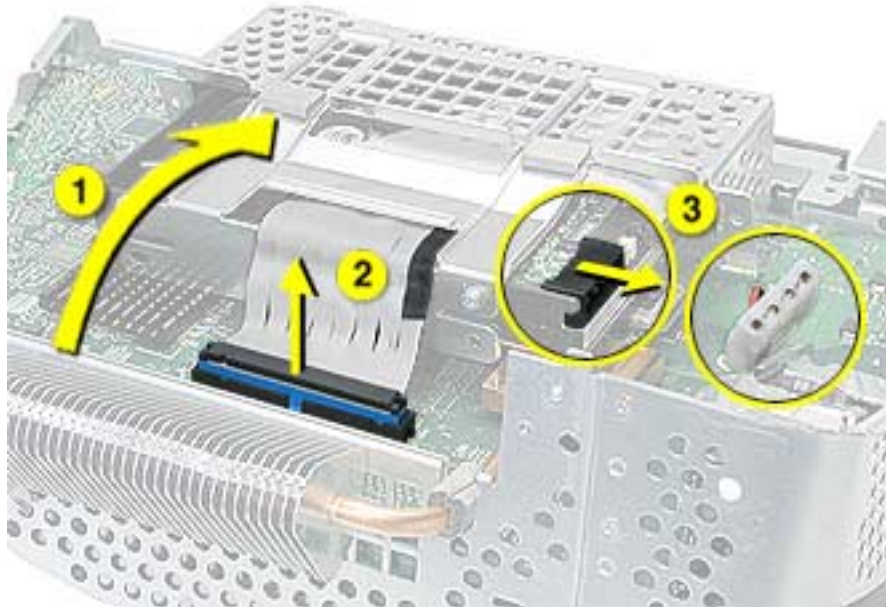

4. To remove the hard drive from the carrier, remove two screws on the side of the carrier.



-
5. Tilt the drive to access the cable. Disconnect the cable from the hard drive. **Note:** If you are replacing the drive carrier, review the procedure “Thermal Pad and EMI Replacement” below.

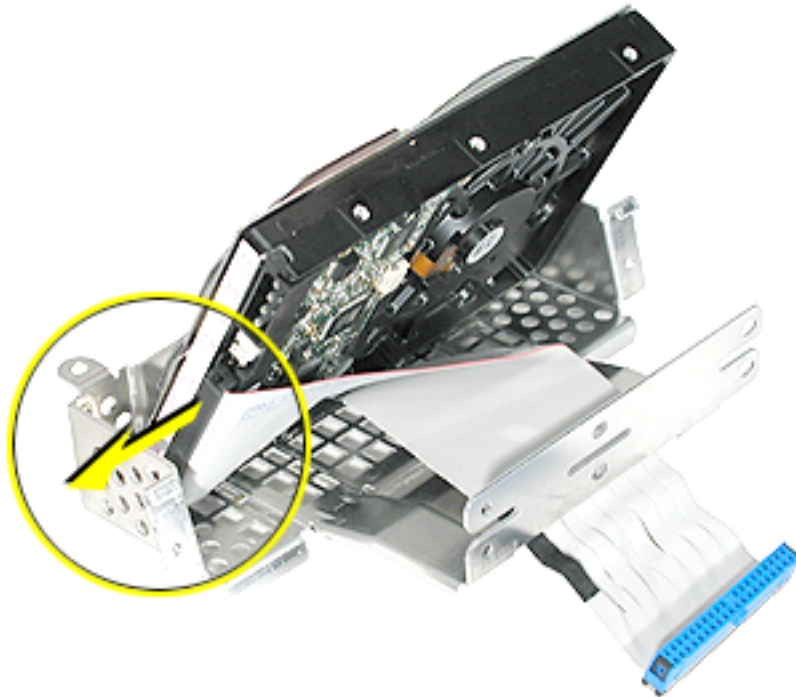

Thermal Pad and EMI Replacement

1. If you are replacing the hard drive carrier, attach the thermal pad, and two rubber bumpers to the top side of the carrier. **Note:** These pieces come with the replacement carrier. Then, go on to the next step.



-
2. Attach two the EMI pads to the bottom side of the carrier.

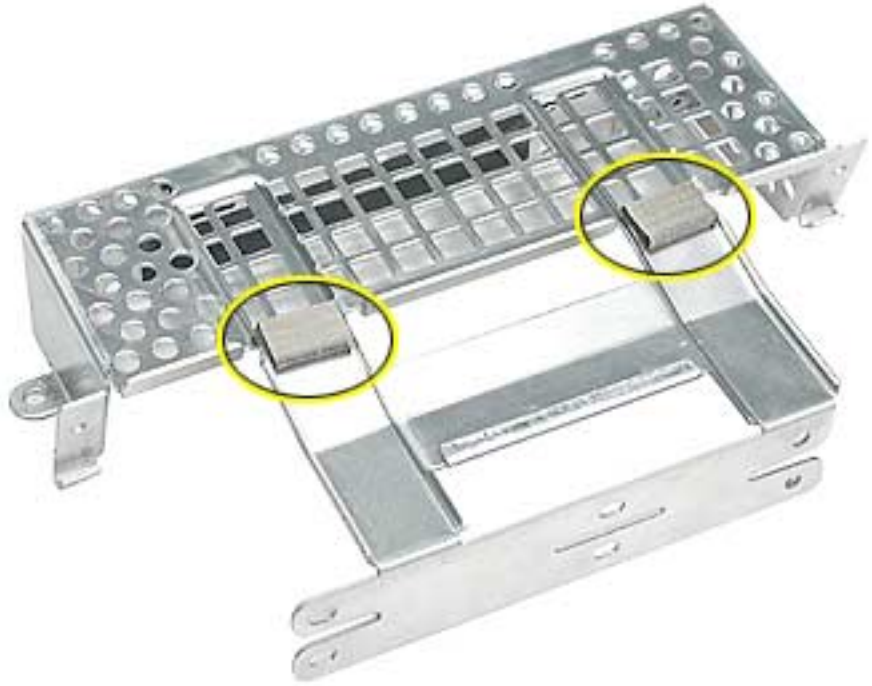



Logic Board Heatsink

Tools

This procedure requires the following tools:

- Screwdriver to pry the heatsink clip

Part Location

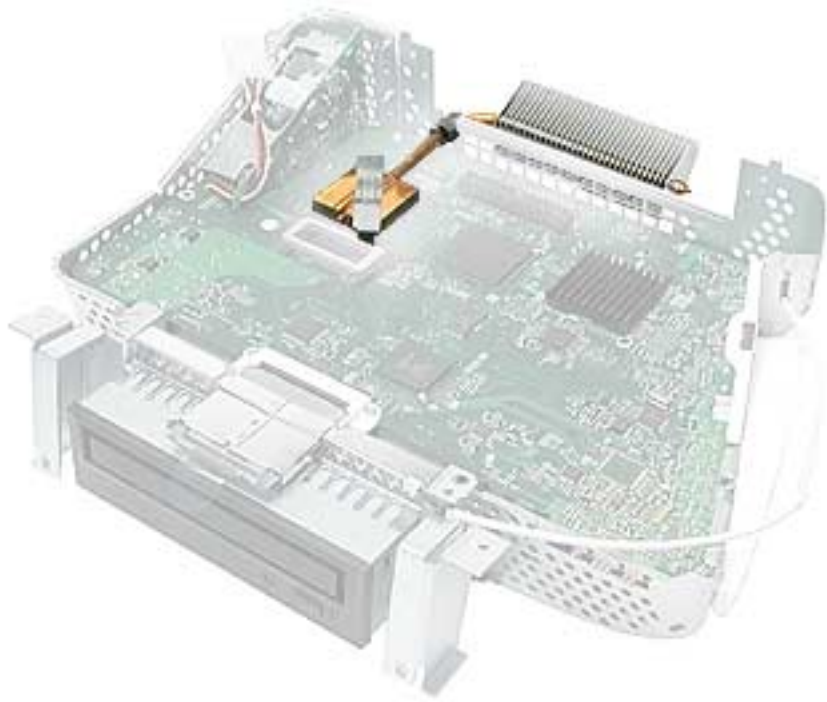

Preliminary Steps

Before you begin, do the following:

- Place the computer face down on an ESD mat.
- Remove the user access door.
- Remove the feet.
- Remove the rear housing.
- Discharge the CRT.
- Remove the fan.
- Remove the Faraday plate.
- Remove the digital assembly.
- Remove the hard drive carrier.

Procedure

1. Remove the one screw attaching to the chassis (on the top left side). Next, with a nylon probe tool (922-5065), push the heatsink clip through the hole in the logic board. The clip will come loose on the top side of the logic board.

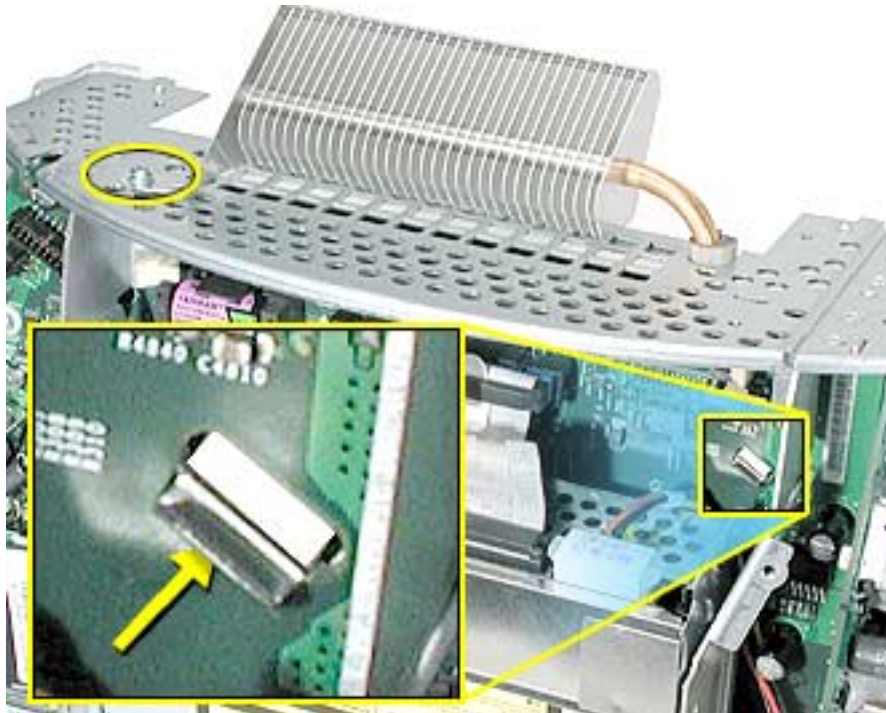

2. Unclip the other end of the heatsink clip on the top side of the logic board.



3. Lift the heatsink from the logic board. **Warning:** The the CPU heatsink should have minimum handling of the fins. Be very careful when handling this part.

Replacement Note: Whenever the heatsink is removed, the bottom side of the heatsink and the top of the microprocessor must be cleaned and new thermal paste must be applied to the microprocessor. If the mating surfaces are not cleaned and thermal paste is not applied, the CPU may overheat and become damaged. Refer to the next topic, “Thermal Paste Application”.

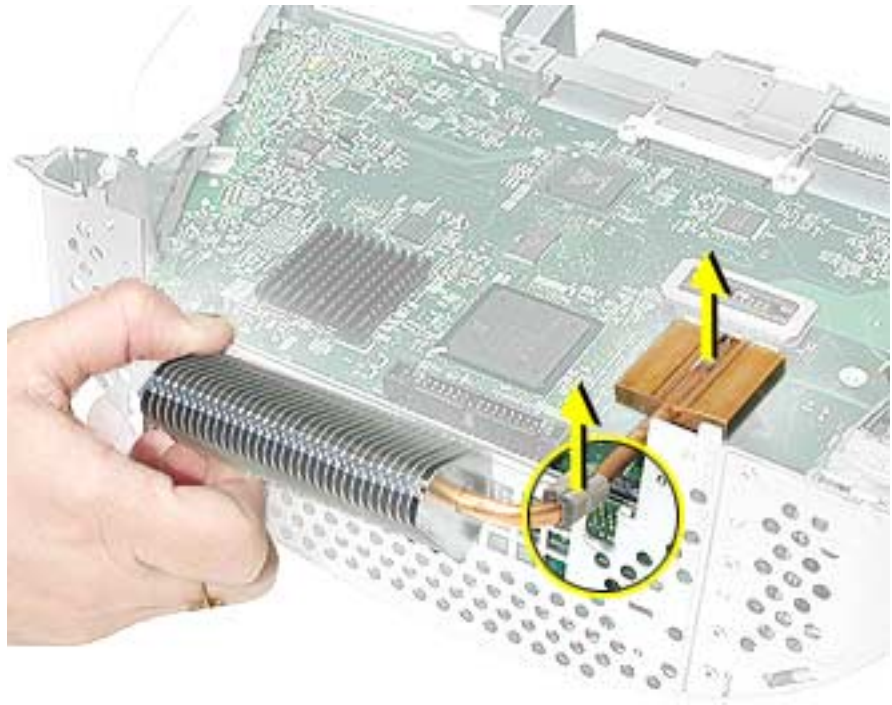



Thermal Paste Application

The microprocessor uses a heatsink/thermal pipe to transfer heat away. Whenever the heatsink is removed, the bottom side of the heatsink and the top of the microprocessor must be cleaned and thermal paste must be applied. If the mating surfaces are not cleaned and thermal paste is not applied, the CPU may overheat and become damaged.

Tools

This procedure requires the following tools:

- Plastic stylus or nylon probe tool (922-5065) to remove the old thermal paste
- Thermal paste (922-4757), each tube contains 4-5 applications

Procedure

1. Thoroughly clean the thermal film from the heatsink surface with a plastic stylus or the nylon probe tool. Do not use an abrasive material or liquid cleaner. **Important:** Be extremely careful not to bend the fins on the heatsink.

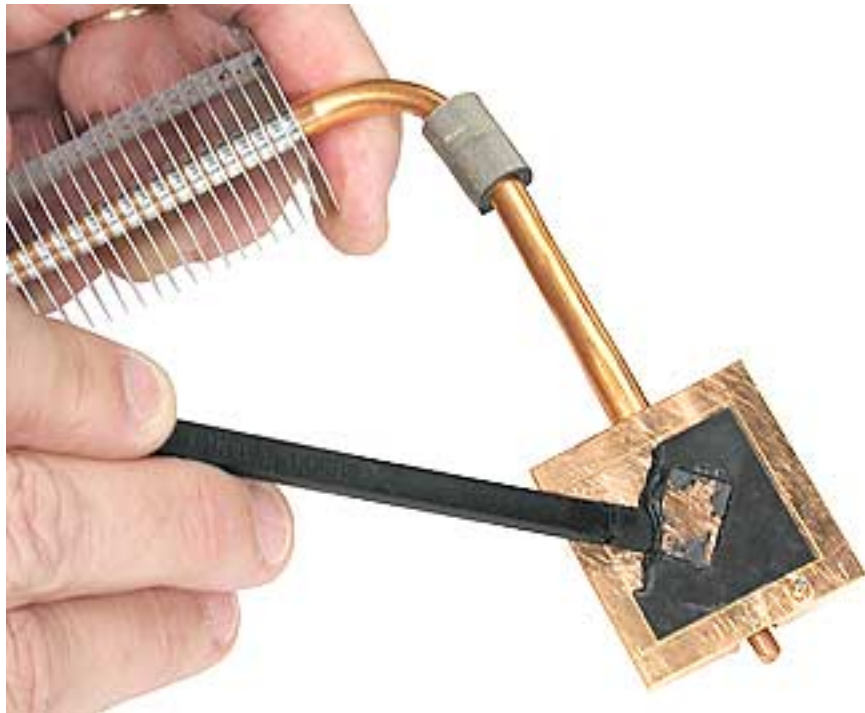

2. Carefully remove the old thermal paste from the surface of the microprocessor. Gently remove the paste with a plastic stylus or nylon probe tool.



3. Squeeze a drop of thermal paste onto the middle of the microprocessor as shown.



4. Spread the paste evenly over the processor. **Important:** On this product, it is critical to spread the paste over the processor, or the chip could overheat.



5. Reinstall the heatsink and the heatsink clip.





Logic Board

Tools

This procedure requires the following tools:

- Phillips #2 screwdriver

Part Location

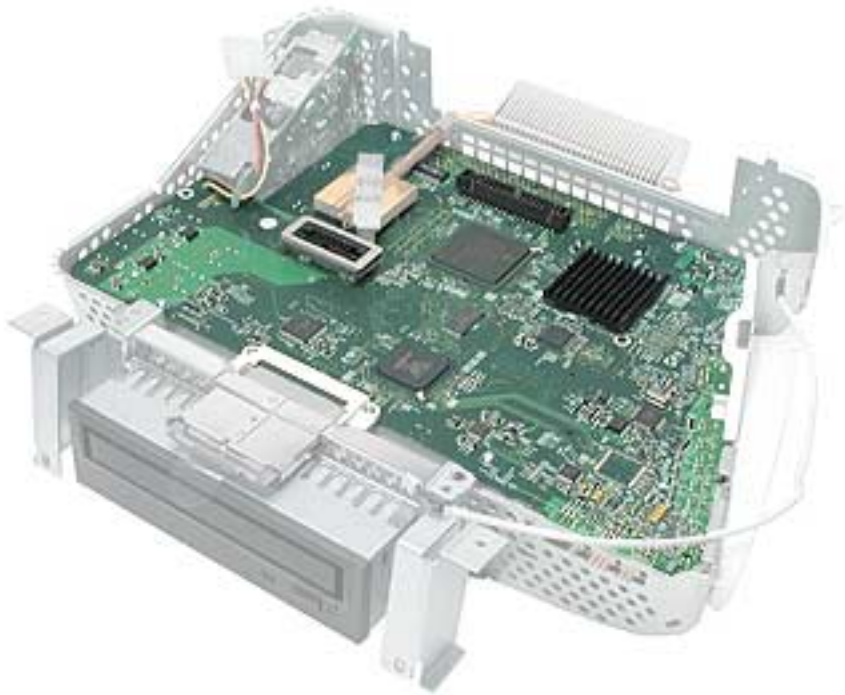

Preliminary Steps

Before you begin, do the following:

- Place the computer face down on an ESD mat.
- Remove the user access door.
- Remove the feet.
- Remove the rear housing.
- Discharge the CRT.
- Remove the fan.
- Remove the Faraday plate.

-
- Remove the digital assembly.
 - Remove the hard drive carrier
 - Remove the AirPort Extreme Card (if present)

Procedure

1. Disconnect the optical data cable, the optical power cable and release the heatsink clip.

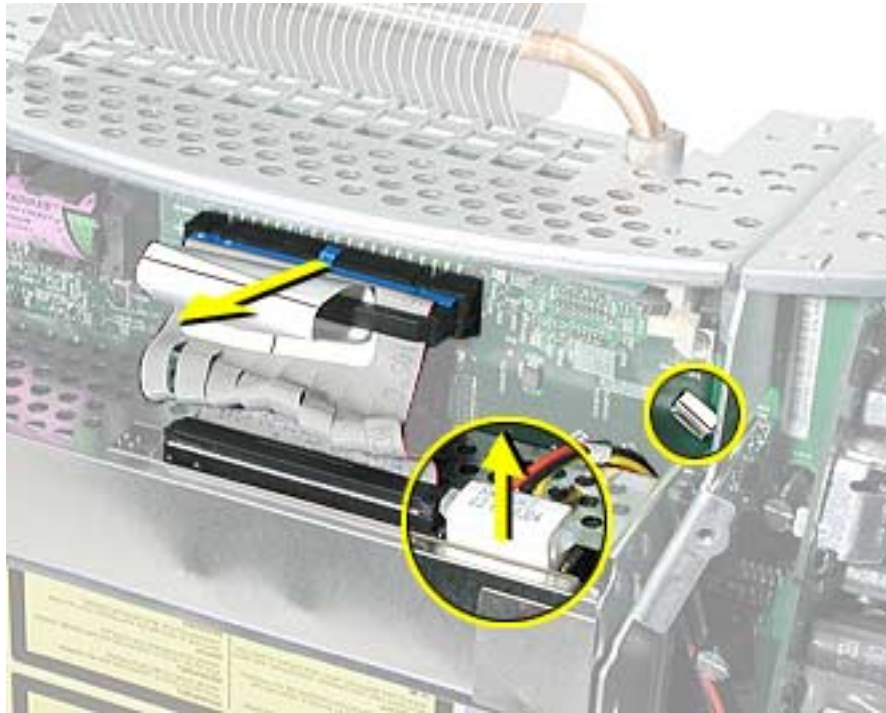

2. Remove the down converter screw that attaches to the chassis frame.



3. On the left side, disconnect the power button cable and the modem cable.

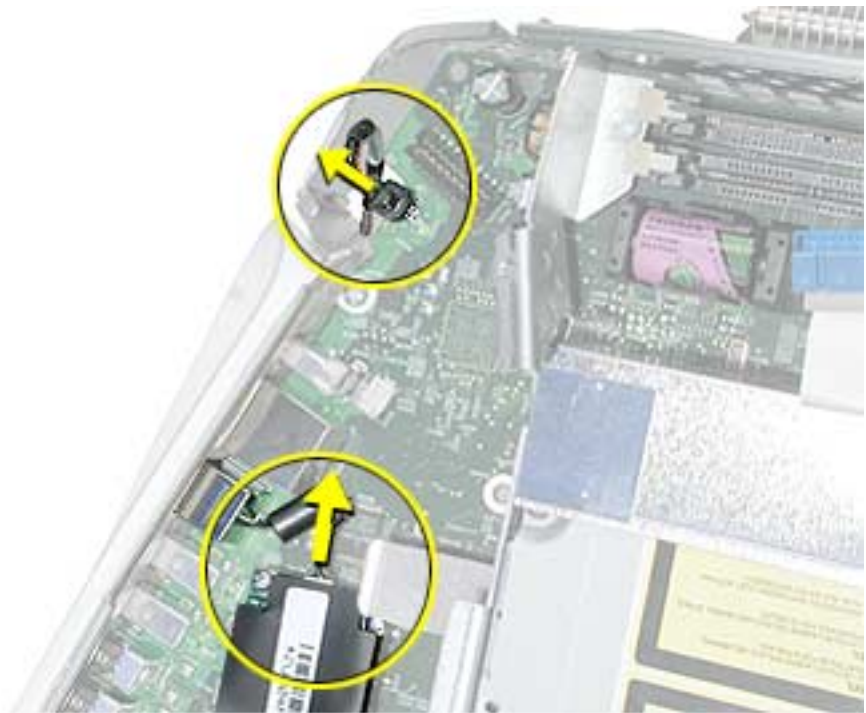

4. Turn the assembly so the logic board is facing up. Remove the heatsink.

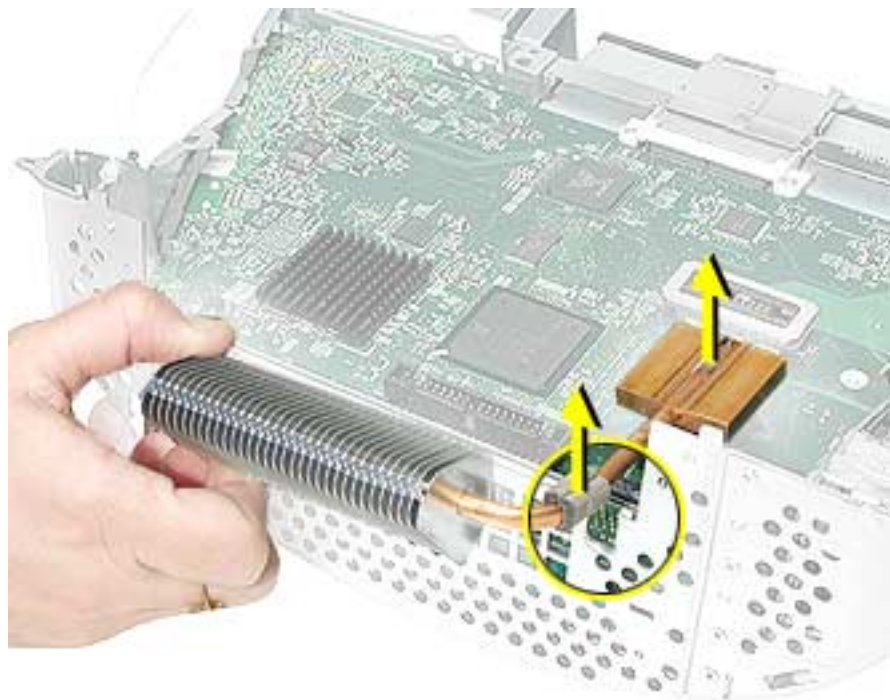

5. Remove the four screws on the logic board.

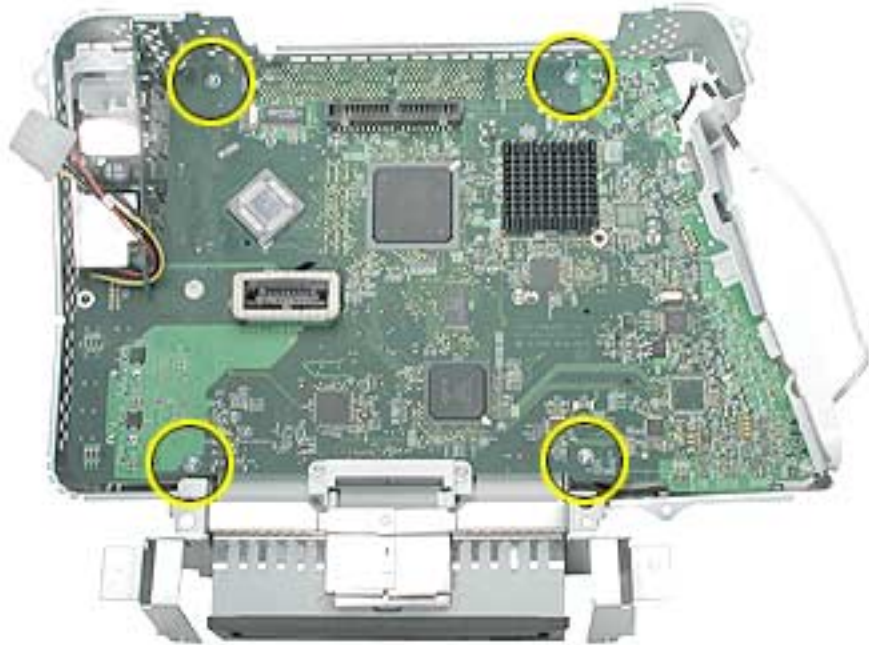

6. To remove the logic board from the chassis frame, unhook the chassis clips under the I/O panel and on the top right side of the chassis frame.

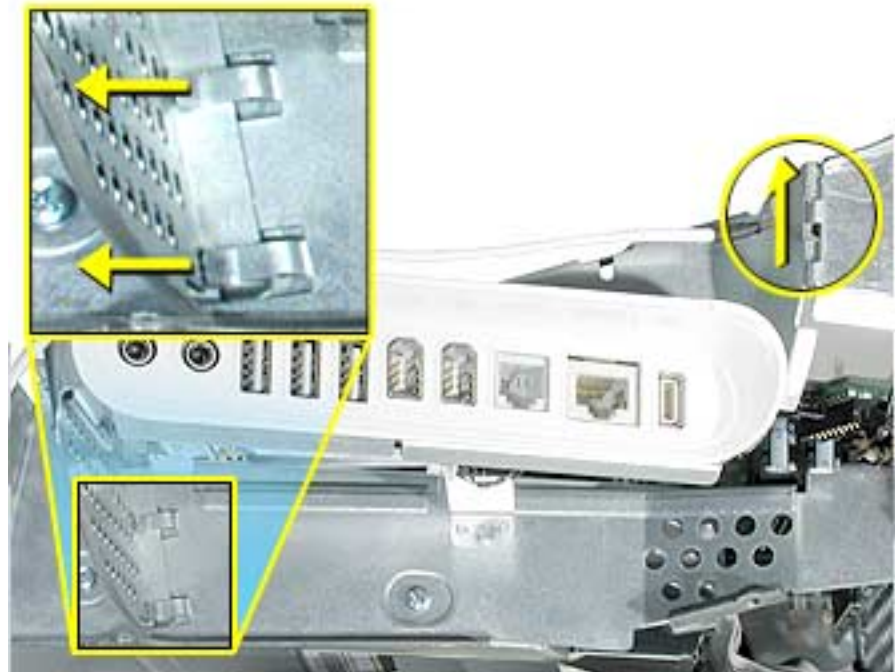

7. Hold the board by the down converter (#1) and gently pull the chassis frame (#2) on the bottom right corner away from the board. Remove the logic board (#3) out of the chassis frame. Carefully maneuver the board out of the frame.

Important: The microprocessor uses a heatsink/thermal pipe to transfer heat away. Whenever the heatsink is removed, the bottom side of the heatsink and the top of the microprocessor must be cleaned and thermal paste must be applied to the microprocessor. If the mating surfaces are not cleaned and thermal paste is not applied, the CPU may overheat and become damaged. Refer to “Thermal Paste Application” in this chapter.

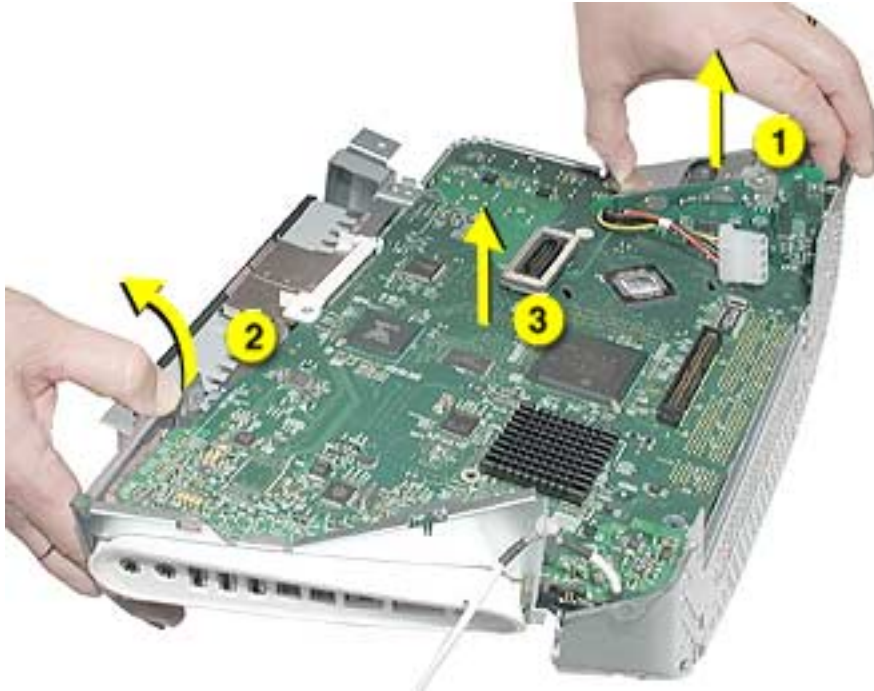

Replacement Note: Before returning the logic board to Apple, remove the following items:

- I/O panel frame
- RJ-11 connector (if present)
- Modem board
- Memory
- Heatsink
- Down converter
- AirPort Extreme Card (if present)



Down Converter

Tools

This procedure requires the following tools:

- Phillips #2

Part Location

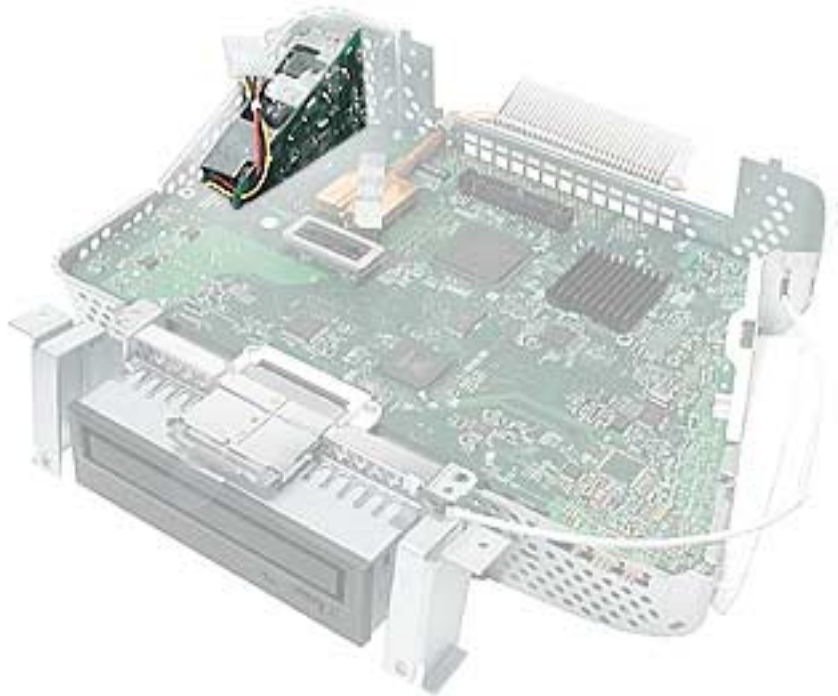

Preliminary Steps

Before you begin, do the following:

- Place the computer face down on an ESD mat.
- Remove the user access door.
- Remove the feet.
- Remove the rear housing.
- Discharge the CRT.
- Remove the fan.
- Remove the Faraday plate.
- Remove the digital assembly.

Procedure

1. Remove the screw attaching the down converter to the chassis frame.

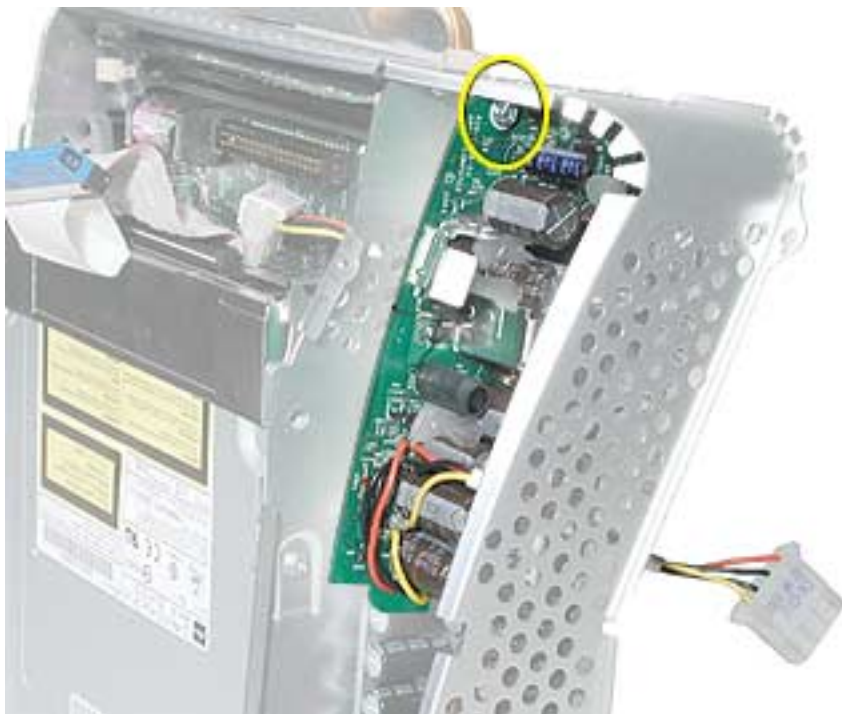

2. Turn the logic board right side up. Hold the board by the down converter (#1) and gently pull the chassis frame (#2) on the bottom right corner away from the board. Remove the logic board (#3) out of the chassis frame. Carefully maneuver the board out of the frame.

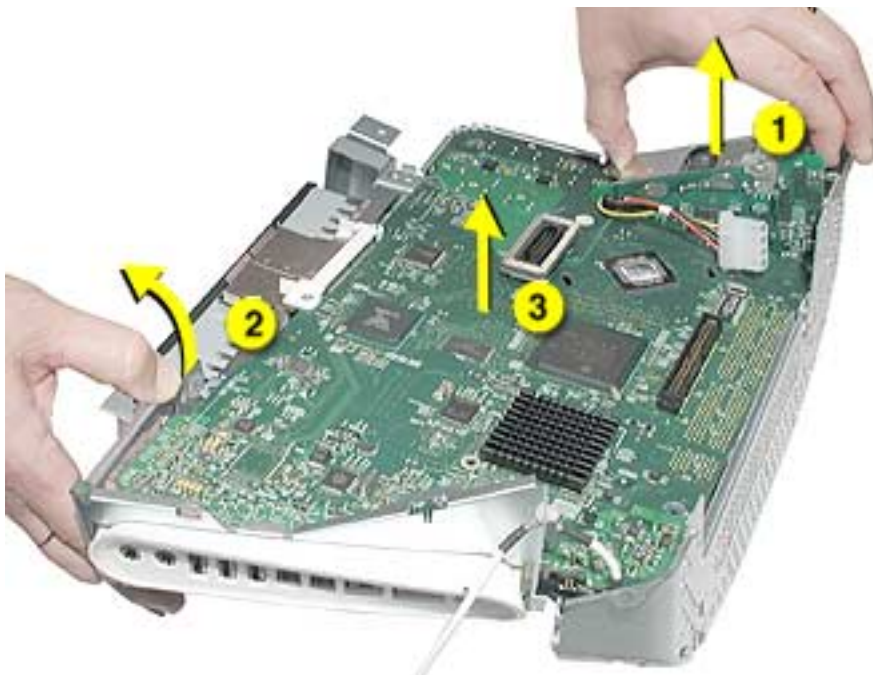

3. Now you can access the down converter board

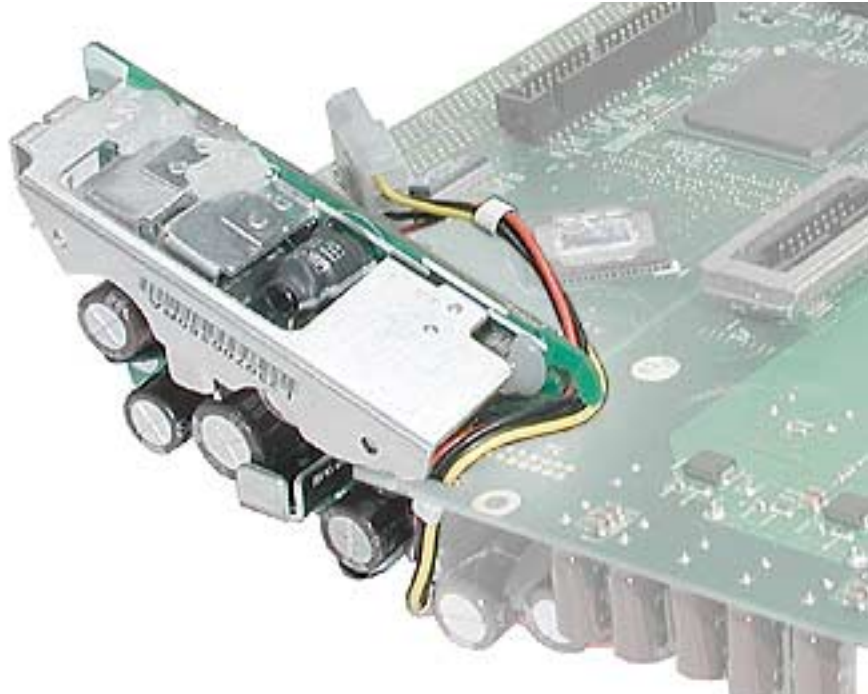

4. Turn the logic board over so you can see the logic board-to-down converter connector. Pull the down converter in the direction of the arrow to disconnect it from the logic board.

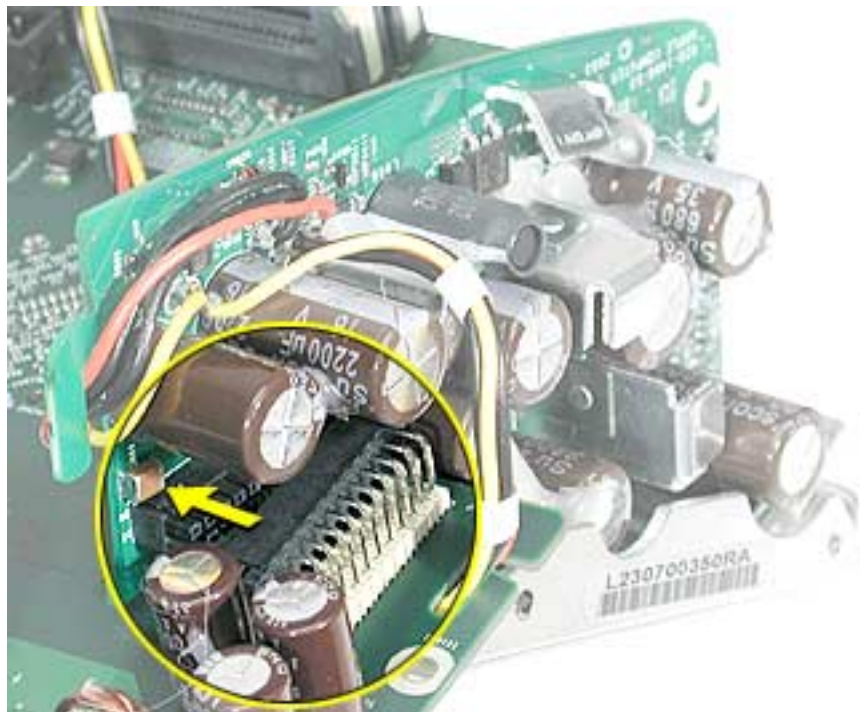

- Slide the down converter off the logic board in the direction of the arrow.
Replacement Note: Note how the cables are routed for reassembly.

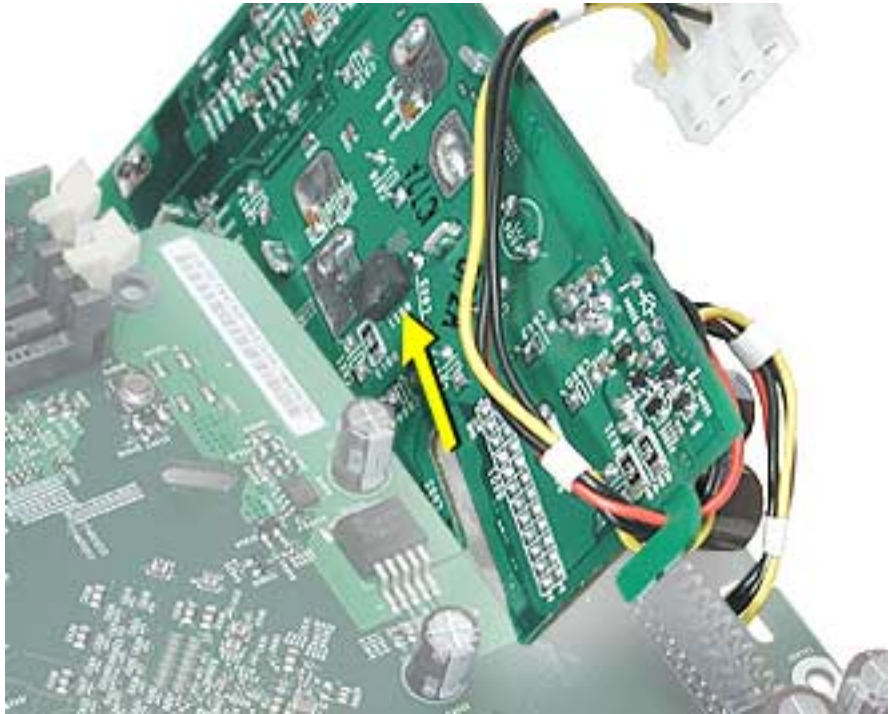



I/O Panel

Tools

This procedure requires the following tools:

- Phillips #2 screwdriver

Part Location



Preliminary Steps

Before you begin, do the following:

- Place the computer face down on an ESD mat.
- Remove the user access door.
- Remove the feet.
- Remove the rear housing.
- Discharge the CRT.
- Remove the fan.
- Remove the Faraday plate.

-
- Remove the digital assembly.
 - Remove the logic board.

Procedure

1. Remove the logic board from the chassis frame to access the I/O panel.



2. Remove the two I/O panel screws.



3. First, pull the I/O panel away from the ports (#1) on the logic board. Next, carefully pull the I/O fence away from the connectors on the end of the board (#2).





RJ-11 Cable

Tools

- Nylon probe tool (922-5065)

Part Location

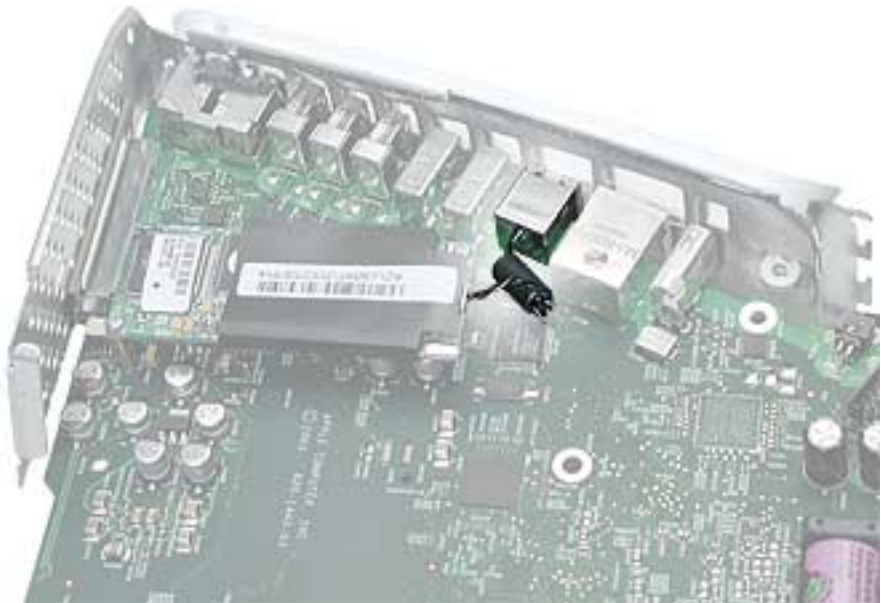

Preliminary Steps

Before you begin, do the following:

- Place the computer face down on an ESD mat.
- Remove the user access door.
- Remove the feet.
- Remove the rear housing.
- Discharge the CRT.
- Remove the fan.
- Remove the Faraday plate.
- Remove the digital assembly.
- Remove the logic board
- Remove the I/O panel

Procedure

1. Disconnect the RJ-11 cable from the modem.

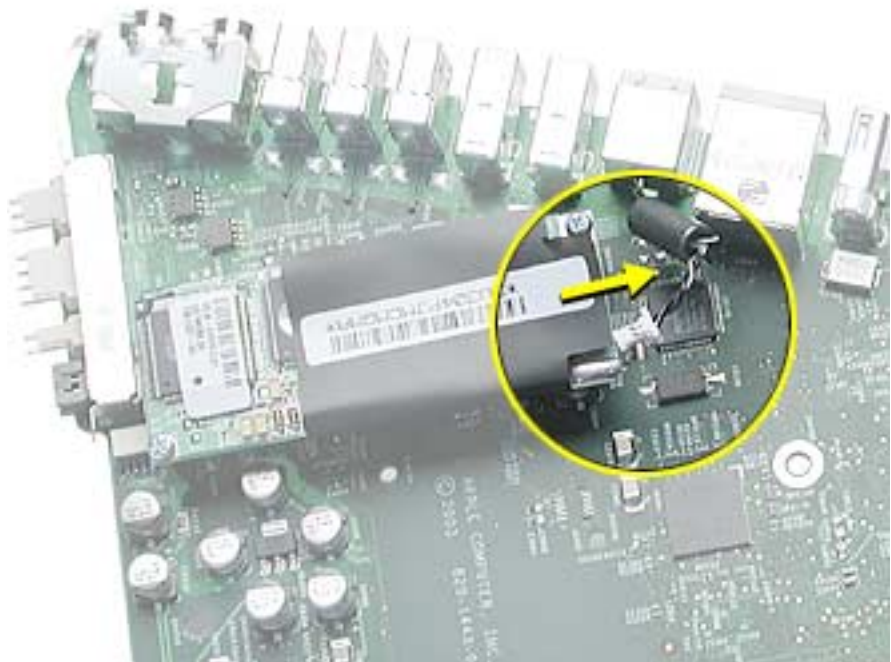

2. Turn over the logic board. There is a small pry slot on the board for a screwdriver blade to get behind the connector. See the next step.

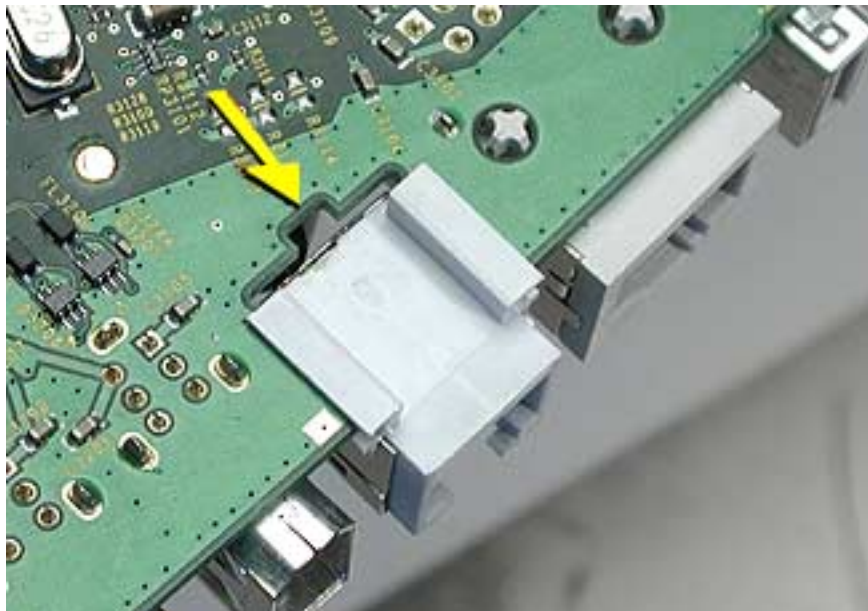

- Carefully push the RJ-11 port connector off the logic board with a nylon probe tool or screwdriver.





AirPort Extreme Card

Tools

This procedure requires the following tools:

- Phillips #2

Part Location



Preliminary Steps

Before you begin, do the following:

- Place the computer so that the front of the computer faces you.

Procedure

1. Press the optical door in on one side and pull the door open on the other side to access the AirPort access panel.

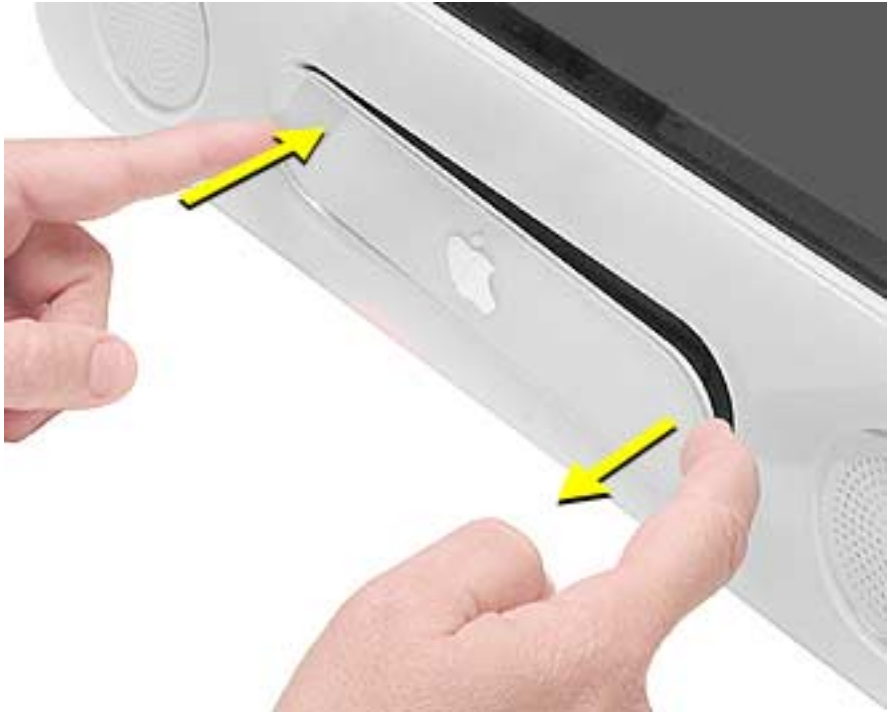

2. Loosen the two captive screws on the access panel. Remove the access panel.



3. Remove the access panel.



4. Untuck the clear tab attached to the AirPort Extreme Card.



5. Pull the AirPort Extreme Card out of the slot a little bit to access the antenna connected to the card.



6. Disconnect the antenna cable from the AirPort Extreme card.



7. Pull the tab to remove the AirPort Extreme card from the slot.



LED

Tools

This procedure requires the following tools:

- Phillips #2

Part Location



Preliminary Steps

Before you begin, do the following:

- Place the computer face down on an ESD mat.
- Remove the user access door.
- Remove the feet.
- Remove the rear housing.
- Discharge the CRT.

-
- Remove the fan.
 - Remove the Faraday plate.

Procedure

1. Remove one screw and disconnect the LED cable. **Important:** The connector is very fragile, remove it gently. Lift the LED board off the front bezel.





Front Bezel

Tools

This procedure requires the following tools:

- Phillips #2

Part Location



Preliminary Steps

Before you begin, do the following:

- Place the computer face down on an ESD mat.
- Remove the user access door.
- Remove the feet.
- Remove the rear housing.
- Discharge the CRT.
- Remove the fan.

-
- Remove the Faraday plate.
 - Remove the digital assembly
 - Remove the display/analog assembly

Procedure

1. Remove the eight bezel screws. There are three on each side and two at the top of the bezel.

Important: DO NOT remove the two larger screws circled below, or the two screws shown in the next photo. If they are removed, the CRT will be out of alignment and the entire display/analog assembly will need to be replaced.

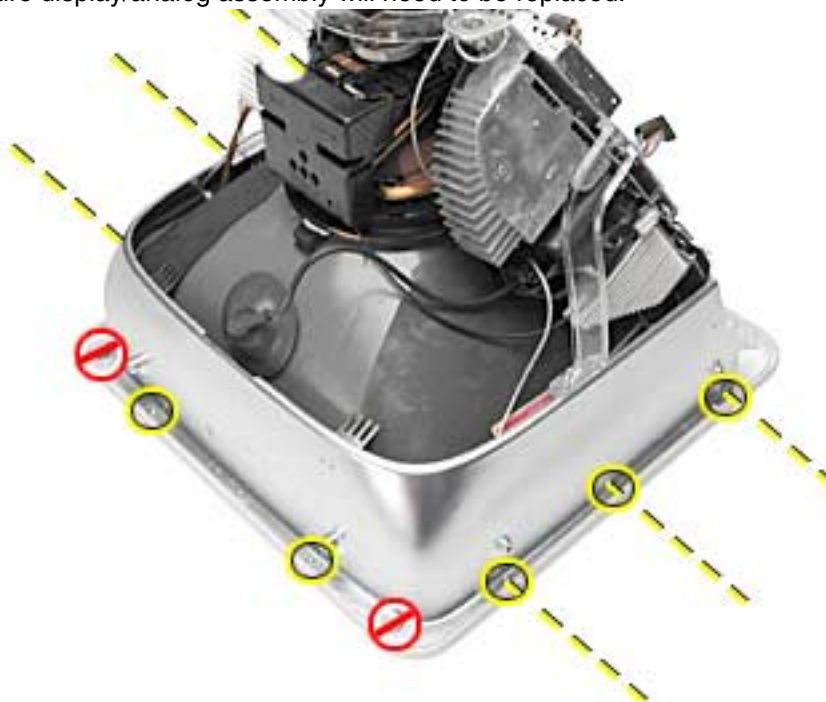

2. **Note:** DO NOT remove the CRT screws (circled) near the speakers either.



3. **Carefully** lift the display/analog assembly off the bezel.

-
4. Remove the microphone, speakers, and LED from the bezel.



5. **Note:** Remove the antenna board from the display/analog assembly before returning the display/analog assembly to Apple. Refer to the next procedure, “Antenna Board” for details.



Antenna Board

Tools

This procedure requires the following tools:

- Phillips #2 screwdriver
- Needlenose pliers or flat blade screwdriver

Part Location



Preliminary Steps

Before you begin, do the following:

- Remove the AirPort Extreme card
- Place the computer face down on an ESD mat.
- Remove the user access door.
- Remove the feet.
- Remove the rear housing.
- Discharge the CRT.
- Remove the fan.

-
- Remove the Faraday plate.
 - Remove the digital assembly.
 - Remove the digital/analog assembly.

Procedure

1. Remove one screw on the antenna board.

Next, peel back the masking tape and pull the unused end of the antenna through the hole in the digital/analog chassis.

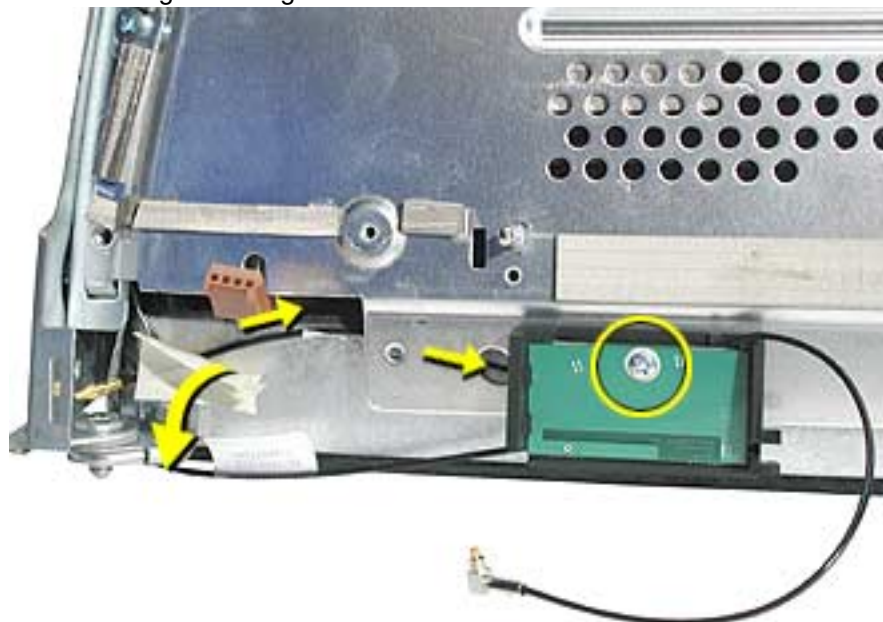

2. Carefully position the computer so that the CRT faces you.

Locate the metal antenna bracket at the top of the CRT. Remove the screw on the bracket, then pry the antenna cable from the two clips on the side of the CRT.





Microphone

Tools

This procedure requires the following tools:

- Phillips #2

Part Location



Preliminary Steps

Before you begin, do the following:

- Place the computer face down on an ESD mat.
- Remove the user access door.
- Remove the feet.
- Remove the rear housing.
- Discharge the CRT.
- Remove the fan.

-
- Remove the Faraday plate.
 - Remove the digital assembly.
 - Remove the display/analog assembly.

Procedure

1. Carefully lift the display/analog assembly from the bezel to access the microphone.
2. Remove the microphone cable from the bezel.





Door Assembly

Tools

This procedure requires the following tools:

- Phillips #2

Part Location



Preliminary Steps

Before you begin, do the following:

- Place the computer face down on an ESD mat.
- Remove the user access door.
- Remove the feet.
- Remove the rear housing.
- Discharge the CRT.
- Remove the fan.

- Remove the Faraday plate.
- Remove the digital assembly.

Procedure

1. Remove the two screws connecting the door to the front bezel. Remove the door from the front bezel.



2. **Replacement Note:** Transfer the serial number label on the inside of the door to the replacement door.





Memory

Tools

- No tools are required for this procedure

Part Location



Preliminary Steps

Before you begin, do the following:

- Place the computer face down on an ESD mat.
- Unplug all cables except the power cord, from the computer.
- Remove the user access door.

Procedure

1. Touch a metal surface inside the computer. Then unplug the computer.

Important: Always ground yourself before you touch any parts, or remove/install any components inside the computer. To avoid generating static electricity, do not walk around until you have finished removing or installing the memory and closed the computer.



2. Push the ejectors on the memory slot outward and down so they are in the open position. Remove the memory module. **Replacement Note:** The memory is designed to fit into the slot only one way. Be sure to align the notches on the module with the small notches inside the slot.





Battery

Tools

- No tools are required for this procedure

Part Location

Note: The battery can be accessed through the user access door on the back of the computer.



Preliminary Steps

Before you begin, do the following:

- Place the computer face down on an ESD mat.
- Unplug all cables except the power cord, from the computer.
- Remove the user access door.

Procedure

1. Touch a metal surface inside the computer. Then unplug the computer. **Important:** Always do this before you touch any parts, or remove/install any components inside the computer. To avoid generating static electricity, do not walk around until you have finished removing or installing the battery and closed the computer.



2. With the nylon probe tool, carefully pry the battery out of the battery holder.





Modem

Tools

This procedure requires the following tools:

- Phillips #1 or jeweler's screwdriver

Part Location



Preliminary Steps

Before you begin, do the following:

- Place the computer face down on an ESD mat.
- Remove the user access door.
- Remove the feet.
- Remove the rear housing.
- Discharge the CRT.
- Remove the fan.
- Remove the Faraday plate.

Procedure

1. Remove the two modem screws and disconnect the RJ-11 cable from the modem.



2. Lift the modem from the connector on the logic board.



Display/Analog Assembly

Tools

This procedure requires the following tools:

- No tools are required

Warning: This product contains high voltage and a high-vacuum picture tube. To prevent injury, always review CRT Safety on Service Source online. This link can be found under the list of topics under the iMac icon. Remember, never use a grounding wriststrap until after discharging the CRT and setting up an ongoing ground connection.

Note: The eMac (ATI Graphics) display/analog assembly requires no voltage calibration or geometry adjustment. Should the display require adjustment (focus, color, or brightness) use the “Displays” pane under System Preferences if using Mac OS X. If using Mac OS 9, use the Monitor Control Panel to make adjustments. If you can not make satisfactory corrections with these tools, replace the display/analog assembly.

Part Location



Preliminary Steps

Before you begin, do the following:

- Place the computer face down on an ESD mat
- Remove the user access door
- Remove the feet
- Remove the rear housing
- Discharge the CRT.
- Remove the fan
- Remove the Faraday plate
- Remove the digital assembly
- Remove the AirPort Extreme Card
- Remove the front bezel
- Remove the antenna.

If you remove everything listed in the steps above, you are left with the display/analog module. There is nothing more to remove from this module.

Note: The display/analog assembly contains a non-switching power supply which is preset at a 220V configuration. The voltage selection needs to be manually set by the way of a voltage jumper. This means if you are operating the computer in a 110V environment, you will have to install the voltage jumper. Refer to the Troubleshooting chapter, “Digital/Analog”

Replacement Note: If you are returning a defective display/analog module, it is imperative that proper packaging guidelines be followed. The packing procedure is included with the replacement assembly. Incorrect packaging can result in damaged eMac (ATI Graphics) displays. Please read and follow the directions enclosed in the shipping box of the new display prior to packaging the defective module.

Failure to package the defective module according to the instructions may result in liability for the cost of the damaged display.



LHR Coil

Tools

This procedure requires the following tools:

- Phillips #2 AirPort Extreme Card screwdriver

Part Location

Note: This part is used in Europe for line conditioning. If your computer does not have the LHR coil, skip this procedure.



Preliminary Steps

Before you begin, do the following:

- Place the computer face down on an ESD mat.
- Remove the user access door.
- Remove the feet.
- Remove the rear housing.
- Discharge the CRT.

Procedure

1. Remove the screw located at the top of the LHR coil.



2. Disconnect the LHR connector located next to the fuse.

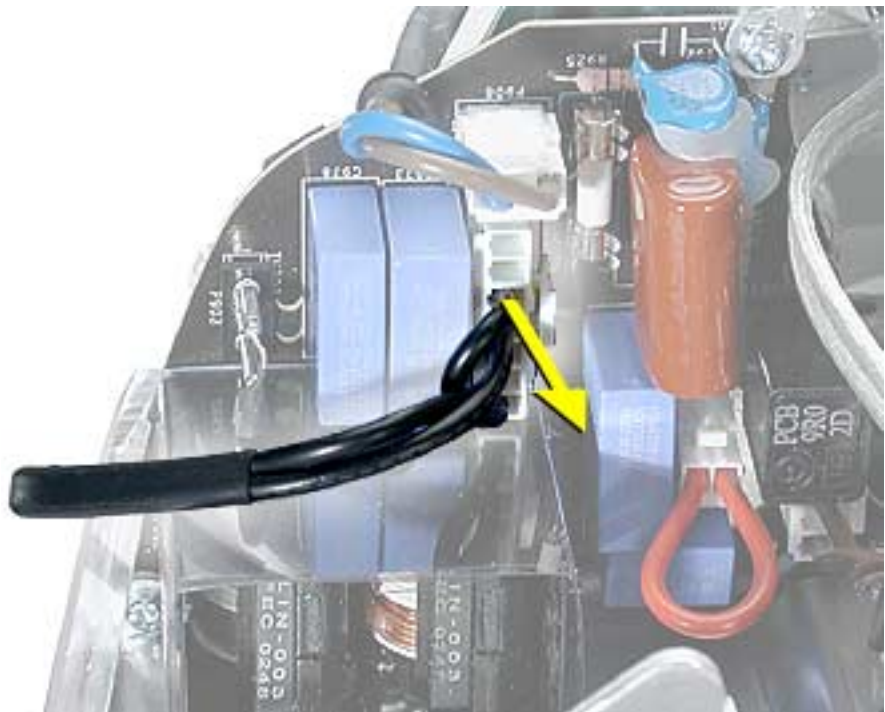

3. Lift the LHR coil from the display/analog frame.



Troubleshooting
eMac (ATI Graphics)



General Information

What's New

1. To quickly identify the eMac (ATI Graphics) computer from the original eMac, look at the user access door on the back of the computer. The user access door on the eMac (ATI Graphics) computer is white. The original eMac has a silver user access door.
2. There are two new logic boards with faster processors: 661-2854 (1GHZ) and 661-2853 (800 MHz).
3. The eMac (ATI Graphics) uses the AirPort Extreme Card for wireless networking. The original AirPort card can not be used in this computer. Previous models of eMac used the original AirPort card. For compatibility information, see AppleCare Knowledge Base article 107440: AirPort Extreme Card: Compatible Macintosh Computers.
4. Note: The AirPort Extreme Card can not be used under Mac OS 9.
5. The PMU reset button is in a new location. Refer to the topic, "The PMU Chip" or "Resetting the PMU on the Logic Board" in this chapter.
6. The digital module assembly has been redesigned allowing easier removal and access to the optical drive without removing the digital module.
7. The heatsink has been redesigned.
8. The voltage jumper and LHR jumper are in new locations on the digital/analog assembly. Refer to "Display/Analog Voltage Setting and LHR Module Instructions" in this chapter for more information.
9. The hard drive carrier has one thermal pad and two rubber bumpers on the top side of the carrier. On the underside of the carrier there are two EMI pads. If you replace the carrier, these pieces come with the replacement carrier and need to be attached before inserting the hard drive.
10. The power button of the eMac (ATI Graphics) replaces the power reset button and programmer's switch (NMI button, also known as a NMI or nonmaskable interrupt button). You can use the power button for the following functions:

Sleep

Press the power button for 1 second to put the computer to sleep. To wake the computer from sleep, press the power button for less than one second or press any key on the keyboard.

Shut down

To shut down the computer, select Shut Down from the Apple menu (Mac OS X) or from the Special menu (Mac OS 9). You will be prompted to save any unsaved documents.

If the computer is unresponsive, you can force the computer to shut down by pressing the power button and holding it for at least 5 seconds. Important: Information in any unsaved documents may be lost.

Firmware updates

From time to time, Apple has provided firmware updates to address certain issues that cannot be addressed in updates to software. On earlier computers, the programmer's switch was used to install a firmware update.

Follow these steps in the event that a firmware update is needed for these computers:

1. Shut down the computer.
2. Wait until the computer is shut down and the power button light is off.
3. Press and hold the power button for several seconds.
4. The computer will signal that a firmware update is ready to be installed by a making a steady tone and the power button light will quickly flash several times for several seconds.

What's Important

1. **Important:** The display/analog (service module) contains a non-switching power supply which is preset at a 220V configuration. The voltage selection is manually set by way of a voltage jumper. This means if you are replacing the display/analog assembly and you will be operating the computer in a 110V environment, you will have to install the voltage jumper on the replacement module. Refer to the inbox instruction included with the display/analog service module, or refer to "Display/Analog Voltage Setting and LHR Module Instructions" discussed later in this chapter.
Note: The LHR coil (line conditioning module) is used in some international countries. Refer to the Take Apart chapter, LHR topic, for take-apart information.
2. **Important:** If you are returning a defective display/analog assembly, it is imperative that proper packaging guidelines be followed. The packing procedure is included with the replacement assembly. Incorrect packaging can result in damaged eMac displays. Please read and follow the directions enclosed in the shipping box of the new display prior to packaging the defective module. Failure to package the defective module according to the instructions may result in liability for the cost of the damaged display.
3. **Important:** Do NOT lift, handle, bump, or manipulate the CRT neck/neck board on the Display/Analog assembly. Modules damaged by mishandling are NOT covered by Apple Warranty. Apple Authorized Service Providers can be liable for broken CRT necks due to improper handling. Refer to "CRT Neck/ Display/Analog Assembly Handling Information" topic in this chapter for more information.
4. The eMac (ATI Graphics) display/analog assembly requires no voltage calibration or geometry adjustment. Should the display appear to require adjustment (focus, color, or brightness) use the "Displays" pane under System Preferences if using Mac OS X. If using Mac OS 9, use the Monitor Control Panel. If you can not make satisfactory corrections with these tools, replace the display/analog assembly.
5. **Important:** The microprocessor uses a heatsink/thermal pipe to transfer heat away. Whenever the heatsink is removed, the bottom side of the heatsink and the top of the microprocessor must be cleaned and thermal paste must be applied to the microprocessor. If the mating surfaces are not cleaned and thermal paste is not applied, the CPU may overheat and become damaged. Refer to "Thermal Paste Application" in this chapter.

Logic Board, Top Side

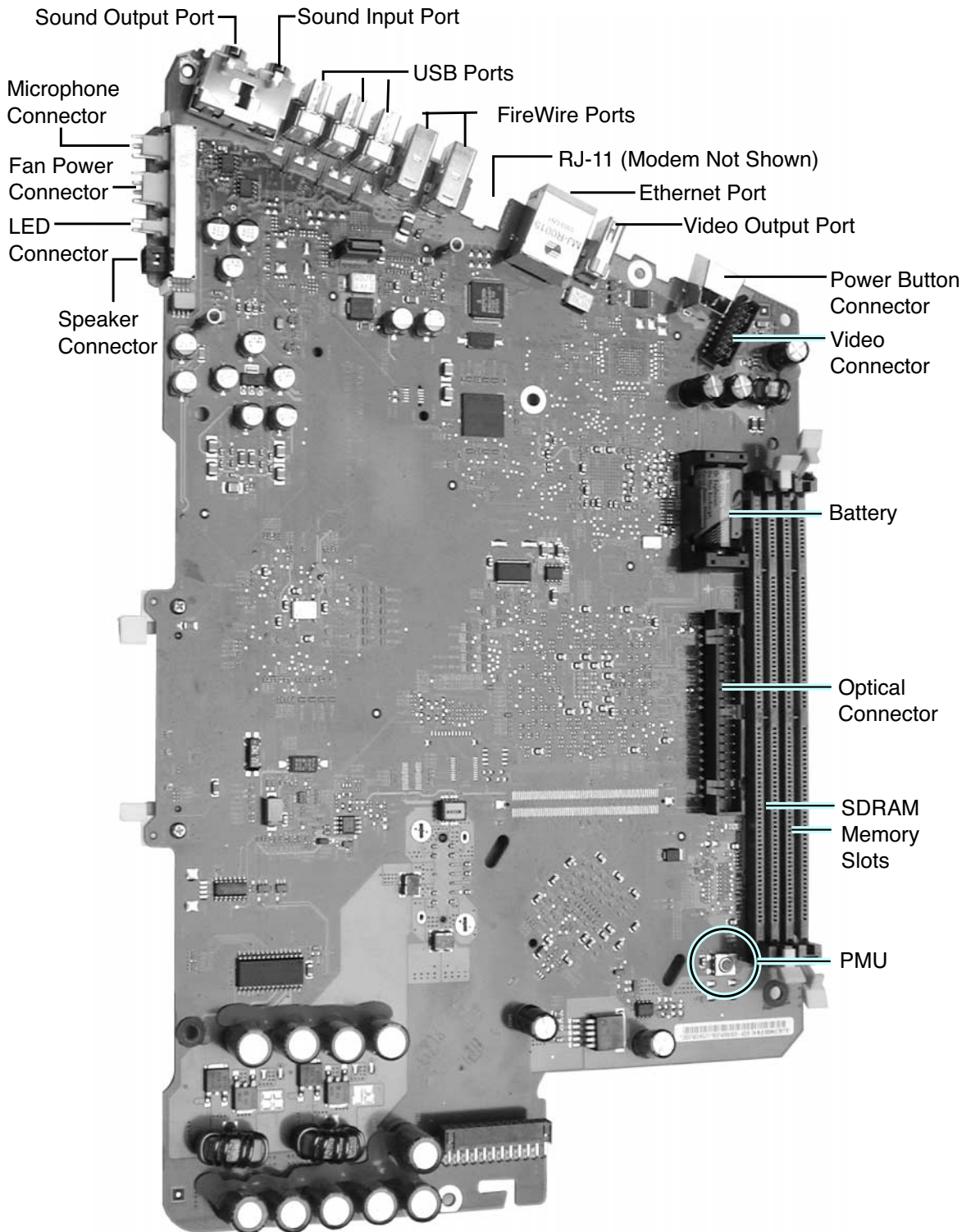

Logic Board, Bottom Side

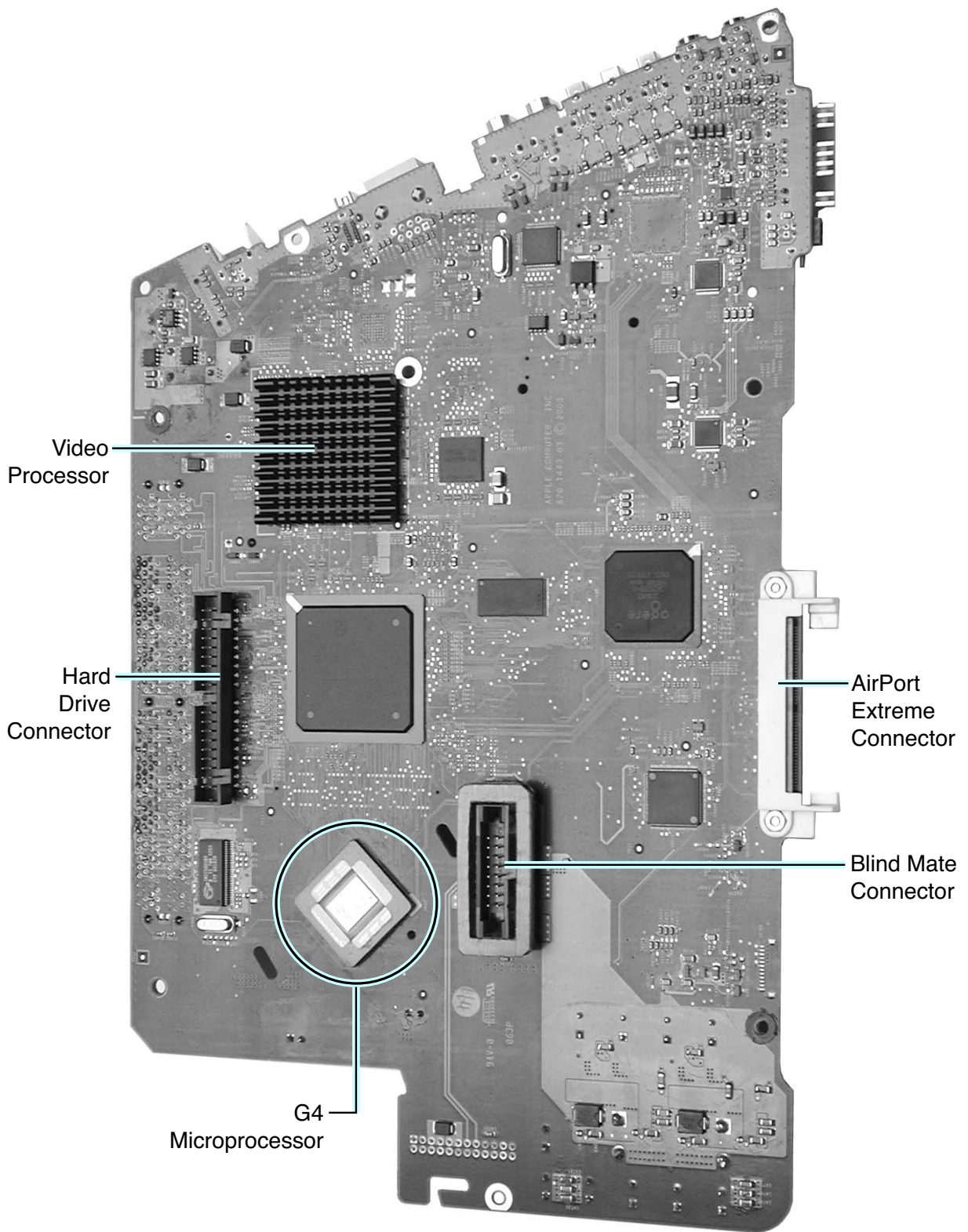

I/O Ports



The ports listed from left to right are:

- Headphone
- Sound out port
- USB ports (3)
- FireWire ports (2)
- Modem
- Ethernet
- Video out port

The PMU Chip

The PMU (Power Management Unit) is a micro controller chip that controls all power functions for the computer. The PMU is a computer within a computer. It has memory, software, firmware, I/O, two crystals, and a CPU. Its function is to:

- Tell the computer to turn on, turn off, sleep, wake, idle, etc.
- Manage system resets from various commands.
- Maintain parameter RAM (PRAM).
- Manage the real-time clock.

Important: The PMU is **very** sensitive and touching the circuitry on the logic board can cause the PMU to crash. If the PMU crashes, the battery life goes from about five years to about two days if the PMU is not reset. Refer to the next topic, “Resetting the PMU on the Logic Board” for the procedure.

Many system problems can be resolved by resetting the PMU chip. The PMU reset button is located behind the user access door, refer to the graphic below.

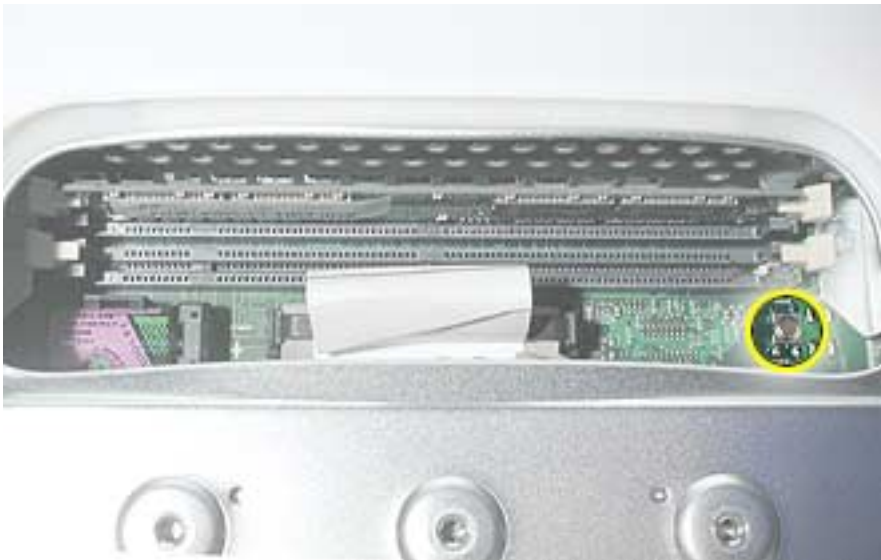

Location of the PMU Reset Button

Resetting the PMU on the Logic Board

Resetting the PMU (Power Management Unit) on the logic board can resolve many system problems. Whenever you have a unit that fails to power up, you should follow this procedure before replacing any modules.

1. Save open documents and quit all open applications.
2. Turn the computer off by choosing Shut Down from the Special menu (if using Mac OS 9), or choose Shut Down from the Apple menu if using OS X.
3. Unplug all cables, except the power cord, from the computer.



4. Place the computer face down on an ESD matt or soft cloth. Remove the user access door screw.



5. Touch the metal surface inside the computer. Then unplug the power cord. This helps protect the computer from damage caused by electrostatic discharge. **Important:** To avoid electrostatic discharge, always ground yourself by touching metal before you touch any parts or install components inside the computer. To avoid generating static electricity, do not walk around the room until you have finished the procedure and closed the computer.



- 6 Press the PMU reset button (shown below) once and then proceed to step 7. Do **NOT** press the PMU reset button a second time because it could crash the PMU chip.

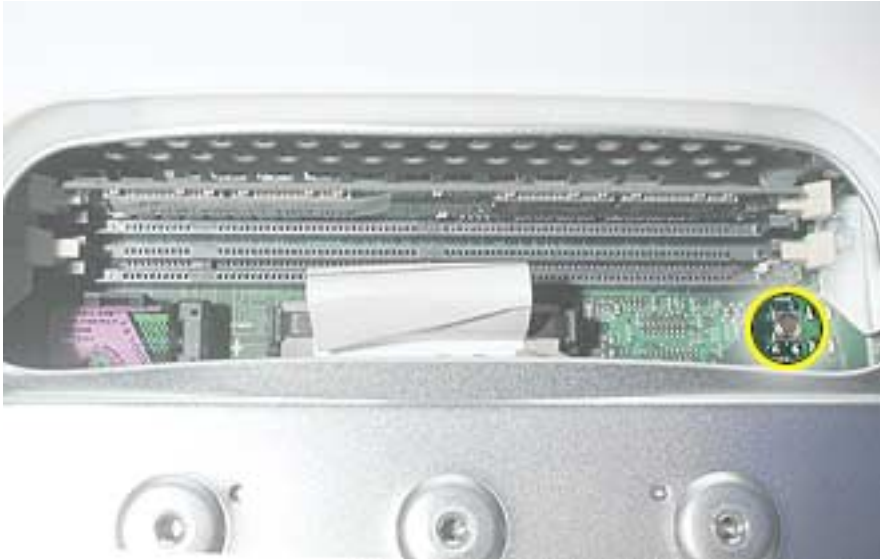

- 7 WAIT ten seconds before connecting the power cord and powering the computer on. If the computer powers on, go to the next step. If the computer does not power on, there is something else wrong with the computer, refer to the symptom/cure, “No Power” in this chapter.
- 8 Run diagnostics, either MacTest Pro (for Mac OS 9 booting systems) or Apple Service Diagnostics (for Mac OS X booting systems) and then return the computer to the customer.

Note: This entire procedure resets the computer’s PRAM. Be sure to reset the computer’s time, date and other system parameter settings before returning the computer to the customer.

Power-On Self Test

There is a power-on self test that resides in the ROM of the eMac. This test automatically runs whenever the eMac is powered on after being fully shut down (the power-on self test does not run if the machine is only restarted).

If a problem is detected during the test, you will not hear a normal startup chime. Instead, the system will beep as explained below. Refer to “Error Beeps” later in this chapter for instructions on how to troubleshoot and repair an eMac that sounds error beeps at startup time.

Following is a definition of what the error beeps at startup time signify.

One Beep: No RAM is installed or detected.

Two Beeps: Incompatible memory is installed. (The slots accept standard PC-100 or PC-133, 168-pin DIMMs).

Three Beeps: No RAM banks passed memory testing.

Four or Five Beeps: Bad checksum for the remainder of the boot ROM. The ROM is bad.

Logic Board Battery

Important: Apple highly recommends removing the battery when handling the logic board. Make sure to use proper ESD protection when handling modules.

The battery on the logic board controls the stored system settings, such as date and time. It is only necessary to test the battery when you can't power on the computer, or the date and time are reset every time the AC power is removed.

The battery is also used to power the PMU chip (because the PMU chip keeps time and must always be running) when the computer is unplugged from the wall (AC power). The PMU is **very** sensitive and touching any circuitry that is connected to the PMU can cause it to crash. If the PMU crashes, the battery life goes from about five years to about two days if the PMU is not reset. Once the battery goes dead, the PMU will reset the time and date every time the AC power is removed. To fix this situation, replace the battery and reset the PMU (refer to "Resetting the PMU on the Logic Board" mentioned earlier in this chapter).

Testing the Battery

If the computer has a “No Power” situation, check the battery before replacing modules. A drained battery may be indicative of a crashed Power Management Unit.

With the battery in the battery holder (under load), measure the voltage across the battery’s positive and ground terminals.

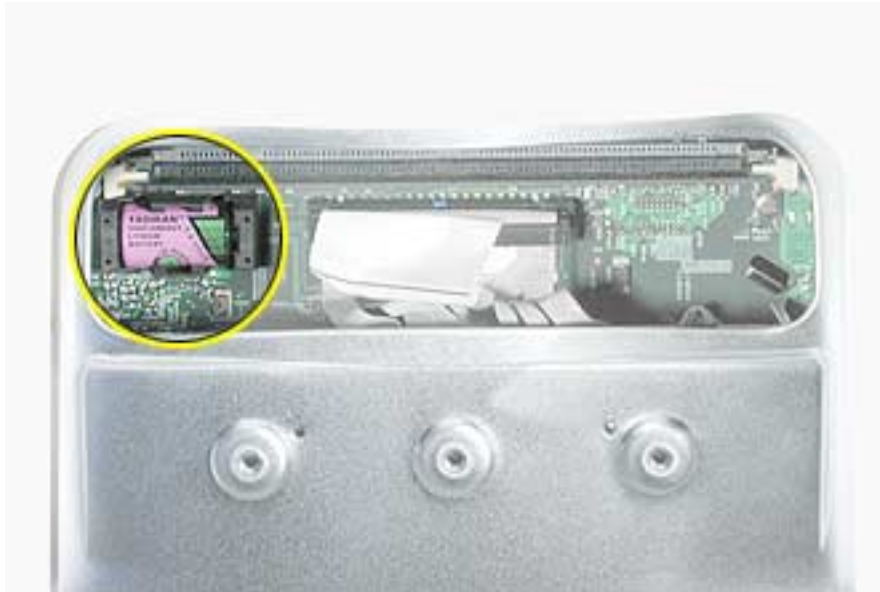

Does the battery measure at least +3.5v? If not, replace the battery and reset the PMU. If the battery does measure over +3.5v, reinstall the battery and reset the PMU as above

Connect the power cord and power up the system again.

Display/Analog Voltage Setting and LHR Module Instructions

The display/analog (service module) contains a non-switching power supply which is preset at a 220V configuration. The voltage selection is manually set by way of a voltage jumper. This means if you are replacing the display/analog assembly and you will be operating the computer in a 110V environment, you will have to install the voltage jumper on the module.

The following instructions explain how to configure the voltage and LHR jumpers on the digital/analog assembly. **Note:** The LHR coil (a line conditioning module) is required in some international countries.

Refer to Table 1 for jumper settings and the following photos for jumper and LHR locations.

Tools

This procedure requires the following tools:

- needlenose pliers to remove/attach the voltage jumper
- phillips #2 screwdriver if attaching the LHR module

Table 1: Jumper Settings

Voltage Environment	Voltage Jumper Setting	LHR Jumper Setting
110 V	Jumper is on	Jumper is on
220 V no LHR module	Jumper is off	Jumper is on
220 V with LHR module	Jumper is off	Jumper is off, LHR module installed

Procedure

1. Locate the voltage jumper circled below. **Note:** This jumper won't be installed on a 220V computer.



2. Next, refer to Table 1 (on the previous page) for the voltage jumper setting and set the jumper accordingly. **Warning: Be careful around the CRT. Discharge the CRT before removing or replacing the jumper.**
3. Locate the LHR coil jumper circled below. Then refer to Table 1 for the LHR jumper setting and set the jumper accordingly.



-
4. Identify if you have the LHR coil (shown below) on the computer. **Note:** The LHR coil (a line conditioning module) is required in some international countries.



5. If you don't have an LHR module, install the replacement display/analog assembly and ensure the jumpers are set correctly. If you have an LHR, go on to step 6.
6. If you have an LHR coil, remove the LHR from the faulty display/analog assembly, place the LHR on the replacement digital/analog assembly, and set the jumpers according to Table 1.

Thermal Paste Application

The microprocessor uses a heatsink/thermal pipe to transfer heat away. Whenever the heatsink is removed, the bottom side of the heatsink and the top of the microprocessor must be cleaned and thermal paste must be applied. If the mating surfaces are not cleaned and thermal paste is not applied, the CPU may overheat and become damaged.

Tools

This procedure requires the following tools:

- Plastic stylus or nylon probe tool (922-5065) to remove the old thermal paste
- Thermal paste (922-4757), each tube contains 4-5 applications

Procedure

1. Thoroughly clean the thermal film from the heatsink surface with a plastic stylus or the nylon probe tool. Do not use an abrasive material or liquid cleaner. **Important:** Be extremely careful not to bend the fins on the heatsink.

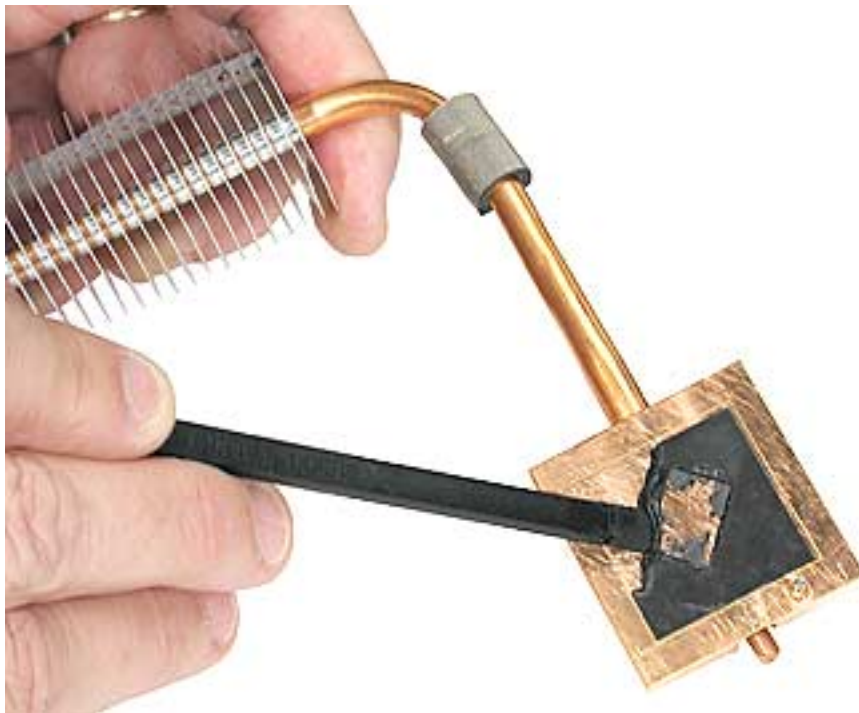

2. Carefully clean the surface of the microprocessor with a plastic stylus or nylon probe tool (922-5065) to remove the old thermal paste.



3. Squeeze a drop of thermal paste onto the middle of the microprocessor as shown.



4. Spread the paste evenly over the processor.



5. Reinstall the heatsink and heatsink clip.



CRT Neck/Display/Analog Assembly Handling Information

Handling

Important: It is imperative that proper handling and packaging guidelines be followed when working with the display/analog assembly.

Do NOT lift, handle, bump, or manipulate the CRT neck/neck board (see arrows below) on the Display/Analog assembly. Modules damaged by mishandling are NOT covered by Apple Warranty. Apple Authorized Service Providers can be liable for broken CRT necks due to improper handling.

Caution: The metal chassis has sharp edges, you may want to wear gloves when handling the assembly. Lift the assembly from the metal chassis; never lift the assembly from the neck. I



Packing a Defective Display/Analog Assembly

The packing procedure is included with the replacement display/analog assembly. Incorrect packaging can result in damaged eMac (ATI Graphics) displays. Please read and follow the directions enclosed in the shipping box of the new display prior to packaging the defective assembly. AASPs can be liable for broken CRT necks due to improper packing and handling.



Symptom Charts

How to Use the Symptom Charts

The Symptom Charts included in this chapter will help you diagnose specific symptoms related to the product. Because cures are listed on the charts in the order of most likely solution, try the cures in the order presented. Verify whether or not the product continues to exhibit the symptom. If the symptom persists, try the next cure.

Note: If you have replaced a module, reinstall the original module before you proceed to the next cure.

Apple Hardware Test

Apple Hardware Test is a diagnostic tool for detecting problems with Apple internal hardware components such as logic board, memory, modem, video RAM, and Apple AirPort Card. The test does not check externally connected hardware components such as USB or FireWire devices; it also does not check non-Apple devices such as third-party PCI cards.

Note: The most recent Apple Hardware Test software can be downloaded from the CD Images page on AppleCare Service Source; go to the Service Source home page and select 'Disc Images' from the quick-click table.

Error Codes

If Apple Hardware Test detects a problem with a computer, it displays an error code, which is defined in the product's Error Code List. Consult the list for appropriate repair procedures associated with the code.

All Error Code Lists are included in the Service Diagnostics Matrix, Knowledge Base article 112125. You can also access this matrix by clicking the Service Diagnostics rollover link under any of the product areas on the Service Source home page.

No Power

The computer will not power on.

1. Verify the power outlet is good. Plug a different device into the socket to ensure there is power, or plug computer into another outlet.
2. Check the power cord. Use a known good power cord.
3. Check connection of the power cord on both ends. Verify that the plug is securely plugged into both the A/C outlet and back of the computer.
4. Remove keyboard, mouse, and other peripherals such as speakers.
5. Position the computer so it rests on the CRT face.
6. Remove the user access door.
7. Touch a metal surface inside the computer.



8. Unplug the unit.
9. Verify the battery is good before replacing modules. A drained battery may be indicative of a crashed Power Management Unit. Does the battery measure at least +3.5v? If not, replace the battery and reset the PMU (see next step).

10. Reset PMU (see below). Refer to “Resetting the PMU on the Logic Board” mentioned earlier in this chapter.



11. Remove the rear housing.

Warning: This product contains high voltage and a high-vacuum picture tube. To prevent serious injury:

- Review the CRT safety information on Service Source online.
- Discharge the CRT
- Never use a grounding wriststrap until after discharging the CRT and setting up an ongoing ground connection.

12. Check the power button cable. Is it routed as shown below? This is correct.



13. Make certain the power button cable is tucked under the metal tab and the black mark on the cable is lined up with the chassis as shown below.



14. Check the power button. Attach a known good power button to the unit. Do you have power now? If yes, replace the power button. If no, go to the next step.
15. Unplug the unit. **Warning:** Make sure the ground screw (see below) is attached to the frame when testing power. Go on to the next step.

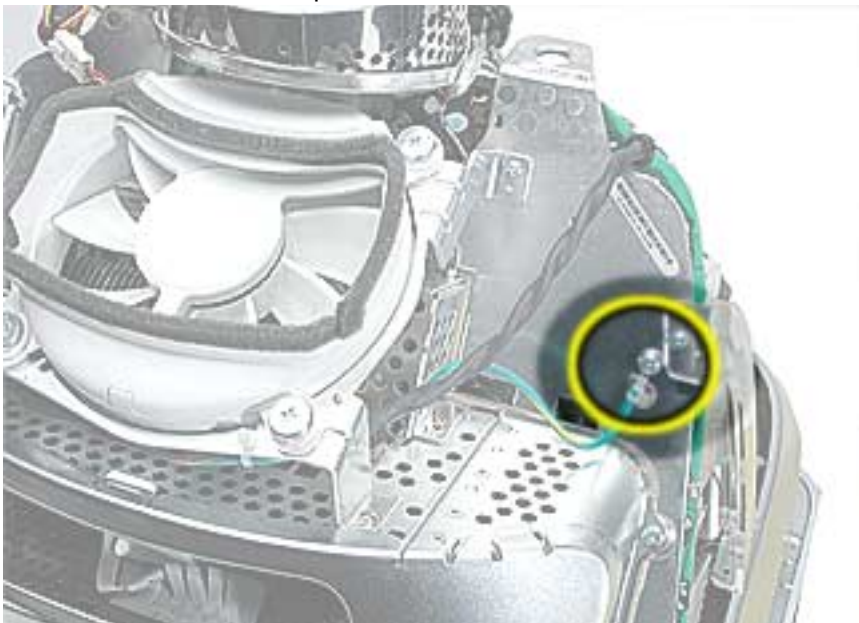

16. Check the AC connector. Make sure it's connected. Do you have power now? If yes, test the unit and return it to the customer. If no, go to the next step.



17. Unplug the computer. Check the fuse (see graphic below). You will need an Ohm meter to do a continuity test on the fuse. Using an ohm meter, touch the red and black probes to the two metal points at location F901 and check for continuity (reading of "0"). If the ohm meter registers "0", the fuse is good. If the meter registers "infinite", the display/analog assembly should be replaced.



18. Unplug the computer and disconnect the AC connector.

19. Plug the computer back in. Make sure that the AC connector is disconnected, and that the ground screw is attached before proceeding to the next step.

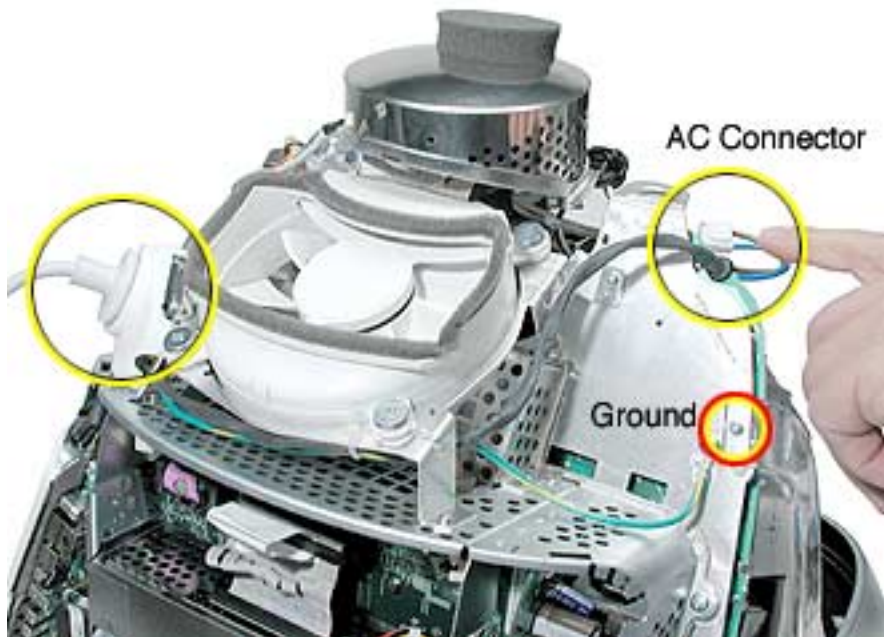

20. Check for AC voltage. Touch the red probe to the contact for the blue wire, and the black probe to ground or the contact to the brown wire of the AC connector. Do you measure 120V (line voltage)? If yes, go on to the next step. If no, replace the fan assembly.

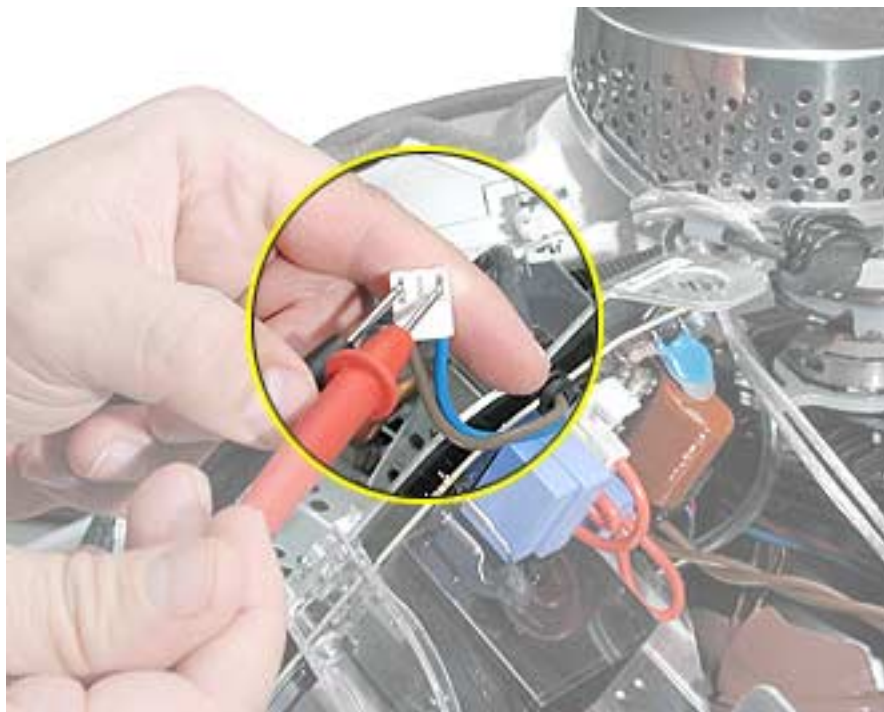

21. With the computer unplugged, reconnect the AC connector.
22. Plug the computer back in. Locate the pins on the down converter shown below.

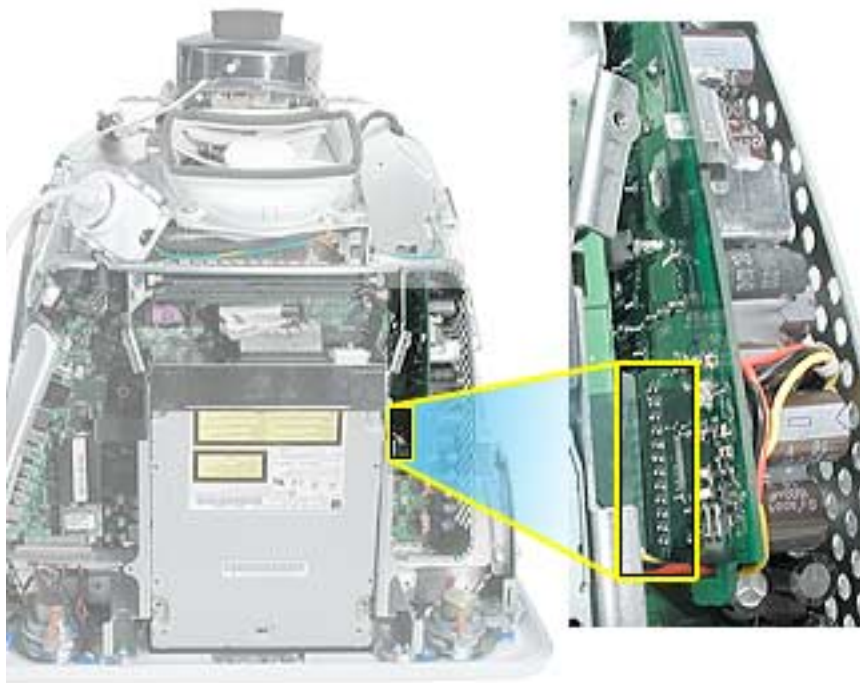

23. Check for down converter “On” voltage. With the black probe grounded, touch the red probe of your meter to pin 3 and then to pin 4 shown below. Did you measure 4.33v on each pin? If yes, go to the next step. If no:
 - Replace the display/analog assembly if you measured 0v.
 - If you measured greater than 0v, but less than 4.33v, go to step 23.

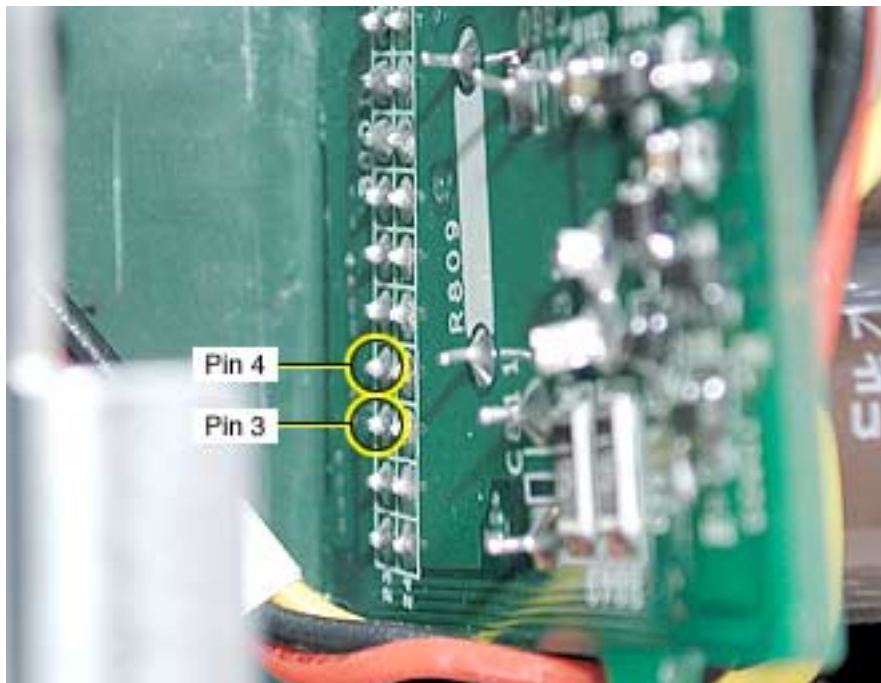

24. Turn the computer on. The voltage at pins 3 and 4 of the down converter should jump to +20.3v. Measure the voltage at pins 3 and 4. Did you measure +20.3v? If yes, replace the logic board. If no, go to the next step.
25. With the computer unplugged, remove the digital assembly (see Take Apart chapter).
26. Reinstall the fan assembly. Remember to connect the AC cable connector and the ground wire. Plug the computer back in and go on to the next step.

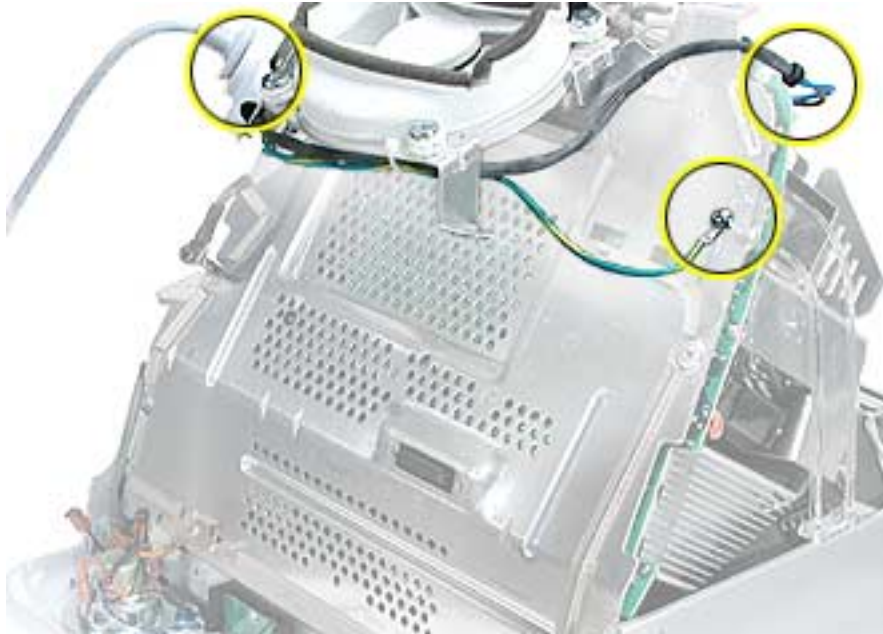

27. Locate the blind mate connector. **Note:** You may need a slim or pointed probe to measure voltages. With your black probe grounded, touch the red probe to pins 7 and 8, on the blind mate connector (bottom row of pins). Pins 7 and 8 should read 12.25v.



-
28. Did you measure the correct voltages at the blind mate connector? If yes, replace the logic board. If no, replace the display/analog assembly.
 29. If the issue persists after the logic board replacement, replace the Down Converter board.

Random Shut Down

While using the computer it just shuts down for no reason.

1. Check the jumper settings, make sure they are set correctly. Refer to the “Digital/Analog Voltage Setting and LHR Module Instructions” mentioned earlier in this chapter. **Note:** There is one jumper for the voltage and one jumper for the LHR coil. Both jumpers should be installed when the computer is operating in the 110V environment. If the jumpers are set correctly, go on to the next step.



Voltage Jumper Location

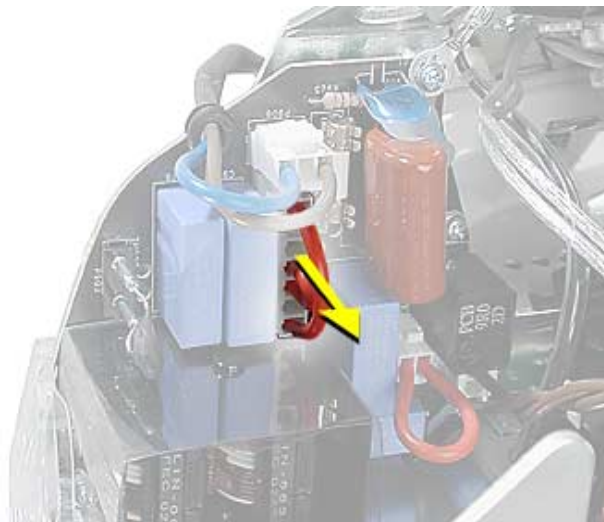

LHR Coil Jumper Location

2. Check the power button. Attach a known good power button to the unit and test. If you can't reproduce the random shut down symptom, replace the power button.

No Video

No video to the internal display, the fan is spinning, there is drive activity

1. Reset parameter RAM. Press Command-Option-P-R during startup.
2. The system software could be damaged. Start up from the system CD that came with the computer.
3. Remove the user access door.
4. Touch a metal surface inside the computer.



5. Disconnect the A/C power cord. Press the PMU reset (circled below) on the logic board. Refer to “Resetting the PMU on the Logic Board” mentioned earlier in this chapter.



6. Check for external video. Connect an external monitor to the video out port. Did you get external video? If yes, replace the display/analog assembly. If no, go on to the next step.
7. Replace the logic board.

Mass Storage

Flashing question mark appears on the screen

1. Boot from the system CD that came with the computer and see if the hard drive mounts on the desktop.
2. Boot from Apple Hardware Test (hold down the “C” key at startup). Run both quick and extended tests. Proceed based on any error codes given. See AppleCare Knowledge Base article 112125 - Service Diagnostics Matrix for Error Code information.
3. If no hard drive is found in Drive Setup, verify the hard drive cable connections.
4. Replace the hard drive cable.
5. Reinstall the software drivers for the hard drive.
6. Reinstall system software. **Note:** Backup the data first.
7. Reinitialize the hard drive.
8. Replace the hard drive.
9. Replace the logic board.

Alternating flashing question mark and a flashing Mac OS face on a folder.

1. This symptom could indicate damaged system software or non-compatible system software. Boot from the system CD that came with the computer and see if the hard drive mounts on the desktop.
2. Boot from Apple Hardware Test (hold down the “C” key at startup). Run both quick and extended tests. Proceed based on any error codes given. See AppleCare Knowledge Base article 112125 - Service Diagnostics Matrix for Error Code information.
3. If no hard drive is found in Drive Setup, verify the hard drive cable connections.
4. Replace the hard drive cable.
5. Reinstall the software drivers for the hard drive.
6. Reinstall system software. **Note:** Backup the data first.
7. Reinitialize the hard drive.
8. Replace the hard drive.
9. Replace the logic board.

Hard drive spins, but won't mount to the desktop

1. Disconnect any connected peripherals.
2. Boot from Apple Hardware Test (hold down the “C” key at startup). Run both quick and extended tests. Proceed based on any error codes given. See AppleCare Knowledge Base article 112125 - Service Diagnostics Matrix for Error Code information.
3. If no hard drive is found in Drive Setup, verify the hard drive cable connections.
4. Replace the hard drive cable.

-
5. Replace the hard drive.
 6. Replace the logic board.

Hard drive does not spin.

1. Disconnect any connected peripherals.
2. Boot from Apple Hardware Test (hold down the “C” key at startup). Run both quick and extended tests. Proceed based on any error codes given. See AppleCare Knowledge Base article 112125 - Service Diagnostics Matrix for Error Code information.
3. Launch Drive Setup and update the hard drive driver.
4. If no hard drive is found in Drive Setup, verify the hard drive cable connections.
5. Replace the hard drive cable.
6. Replace the hard drive.
7. Replace the down converter.
8. Replace the logic board.

System hangs during normal startup process

1. Boot from the system CD that came with the computer and see if the hard drive mounts on the desktop. Boot from Apple Hardware Test (hold down the “C” key at startup). Run both quick and extended tests. Proceed based on any error codes given. See AppleCare Knowledge Base article 112125 - Service Diagnostics Matrix for Error Code information.
2. Using Drive Setup, reinitialize the hard drive.
3. Check all cable connections to and from the hard drive.
4. Replace the hard drive cable.
5. Replace the hard drive.
6. Replace the logic board.

CD or DVD tray won't open

1. Check for obstructions on the optical drive door.
2. Replace the optical drive cable.
3. Replace the optical drive.
4. Replace the down converter.
5. Replace the logic board.

Optical drive tray won't accept a CD or DVD

1. Check for obstructions on the optical drive door.
2. Replace the optical drive cable.
3. Replace the optical drive.
4. Replace the down converter.
5. Replace the logic board.

CD or DVD disc constantly ejects at startup

1. Try cleaning the disc. If it is dirty or scratched, it may not mount.
2. Try a known good disc.
3. Disconnect all peripheral devices, especially the mouse in cases where the disc is constantly ejecting. This symptom may be an indication of a failed mouse giving a signal that the mouse is stuck in the down position. Try a known good mouse.
4. Boot from Apple Hardware Test (hold down the "C" key at startup) or boot from the system install CD (use Startup Manager, hold down the Option key at startup).
5. Perform a clean install with the CD that came with the computer.
6. Replace the optical drive cable.
7. Replace the optical drive.
8. Replace the down converter.
9. Replace the logic board.

Optical drive doesn't spin

1. Replace the optical drive cable.
2. Replace the optical drive.
3. Replace the down converter.
4. Replace the logic board.

CD or DVD won't mount to the desktop

1. Try cleaning the disc. If it is dirty or scratched, it may not mount.
2. Boot from Apple Hardware Test (hold down the "C" key at startup). Run both quick and extended tests. Proceed based on any error codes given. See AppleCare Knowledge Base article 112125 - Service Diagnostics Matrix for Error Code information.
3. Try a known good disc.
4. Refer to the "Flashing Question Mark" symptoms mentioned in this section.
5. Perform a clean install with the CD that came with the computer.
6. Replace the optical drive cable.
7. Replace the optical drive.
8. Replace the logic board.

Sound Out

No sound from either internal or external speakers

1. Verify volume setting is correct in system preferences.
2. Verify the computer is not set to “mute”. Press the mute key on the Apple keyboard.
3. Reset parameter RAM. Press Command-Option-P-R during startup.
4. Boot from Apple Hardware Test (hold down the “C” key at startup). Run both quick and extended tests. Proceed based on any error codes given. See AppleCare Knowledge Base article 112125 - Service Diagnostics Matrix for Error Code information.
5. Test the computer with known-good headphones. Do you get sound? If yes, go on to step 6. If no, replace the main logic board.
6. Verify that the speaker cable is connected.
7. Replace the speaker assembly.
8. Replace the logic board.

No sound from the headphones

1. Verify the problem with known-good headphones.
2. Verify the computer is not set to “mute”. Press the mute key on the Apple keyboard.
3. Verify volume setting is correct in Mac OS X system preferences. If the preferences are set correctly, replace the logic board.
4. In Mac OS 9, check the Sound Control panel, Speakers tab. When headphones are connected, a headphone icon will be present. If the headphone jack is malfunctioning it may indicate that headphones are connected when none are connected. In this case, replace the logic board.

Sound In

No sound is recorded

1. Check setup of the system preferences for the microphone.
2. Check that the microphone is picking up sound by testing the audio in iMovie. Click on the Audio button. Record something. The audio bar on the screen should indicate if the microphone is working.
3. Boot from Apple Hardware Test (hold down the “C” key at startup). Run both quick and extended tests. Proceed based on any error codes given. See AppleCare Knowledge Base article 112125 - Service Diagnostics Matrix for Error Code information.
4. Check the microphone cable connection.
5. Replace the internal microphone.
6. Replace the main logic board.

Error Beep(s)

Computer beeps at startup.

1. RAM expansion DIMMs for the eMac must be PC133 compliant and use SDRAM devices. If the user installs a DIMM that uses EDO or SGRAM devices, the computer will beep several times when the user attempts to restart the computer.
2. Refer to “Power-On Self Test” mentioned earlier in this chapter.

Long tone at startup

A long tone at startup can indicate that the power button is being held in, or is malfunctioning. This tone is normal when purposely holding the button in during startup.

1. Attach a known good power button to the unit and test. If the tone no longer sounds at startup, replace the power button.

Modem

No modem dial tone

1. Verify known-good analog (not digital) telephone line.
2. Verify known-good RJ-11 telephone cable.
3. Verify RJ-11 cable is not plugged into Ethernet port.
4. Inspect RJ-11 connector and modem port for pin damage.
5. Verify RJ-11 cable is firmly installed in the modem port.
6. Boot from Apple Hardware Test (hold down the “C” key at startup). Under “Test Result”, check to see if the Modem reports 'Device found'. If it reports “No Device Found”, proceed as the Error Code list recommends for Apple Hardware Test. See AppleCare Knowledge Base article 112125 - Service Diagnostics Matrix for Error Code information.
7. Open the bottom housing. Verify the internal RJ-11 modem cable is connected to the modem.
8. Replace the RJ-11 cable/ jack.
9. Replace the modem.
10. Replace the logic board.

USB Printing Problems

eMac cannot print to attached known-good printer.

1. Verify that the printer is Macintosh compatible.
2. Verify that you have setup the printer correctly in OS X.
3. Refer to Knowledge Base article 106714, Mac OS X: How to Print
4. Reinstall the printer driver.
5. Switch the printer to another USB port.
6. Check the USB port with a known good USB device like the keyboard or mouse.
7. Replace the printer interface cable.
8. System software is corrupted. Reinstall the system software.
9. Replace the logic board.



Upgrades
eMac (ATI Graphics)



Memory

Tools Required

- #2 Phillips screwdriver

Opening the User Access Door

1. Save all open documents and quit all open applications.
2. Turn the computer off by choosing Shut Down from the Special menu (if using Mac OS 9), or choose Shut Down from the Apple menu (if using OS X).
3. Unplug all cables, except the power cord, from the computer. (Figure 1)
Warning: If the internal modem is connected to a telephone line, disconnect the telephone line from the internal modem port before you open the user access door. This prevents electric shock.

Figure 1



4. Place a soft towel or cloth on the desk or surface. Position the computer so the screen is facing down on the cloth.
5. Use a Phillips screwdriver to remove the screw on the user access door. Set the user access door aside. (Figure 2)

Figure 2



-
6. **Important:** To avoid electrostatic discharge, always ground yourself by touching metal before you touch any parts or install components inside the computer. To avoid generating static electricity, do not walk around the room until you have finished installing the memory and closed the computer.

Touch the metal surface on the back of the computer. (Figure 3) This helps protect the computer from damage caused by electrostatic discharge.

Figure 3



7. Unplug the power cord.

Removing the Installed Memory

1. Push down the ejectors on the slot of the memory module you want to replace. (Figure 4)

Figure 4

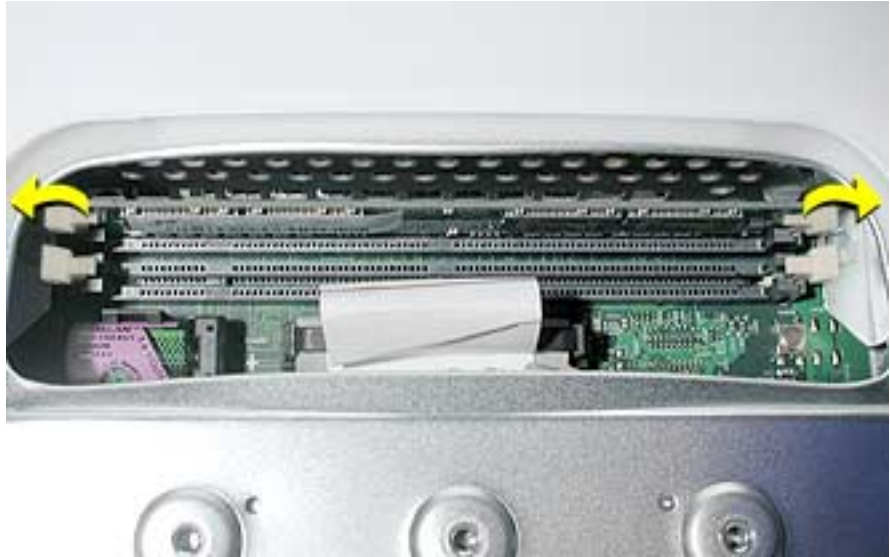

2. Holding the memory by both top corners, pull it straight out of the computer.

Installing Memory

1. Remove the replacement memory from its static-proof bag, taking care not to touch the connectors or chips.
2. Push down the ejectors on the slot of the memory module you want to install or replace memory. (Figure 5)

Figure 5



3. Align the replacement memory module in the memory slot, apply pressure evenly to both top corners, and push the memory into the slot until the ejectors lock it into place. (Figure 6)

Warning: The memory is designed to fit into the slot only one way. Be sure to align the notches in the memory module with the small ribs inside the slot.

Figure 6

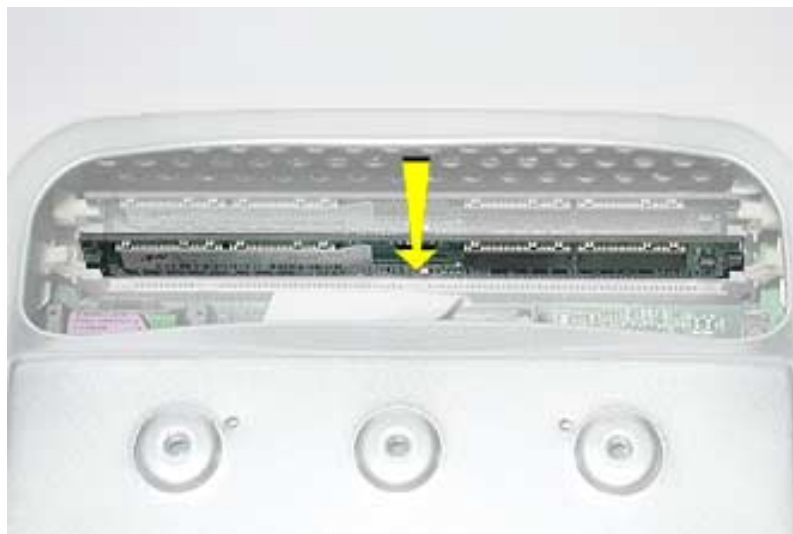

Closing the User Access Door

1. Replace the screw on the user access panel. (Figure 7)

Figure 7



2. Carefully turn the computer right side up.
3. Reconnect the power cable. **Important:** When connecting the power cord, first plug the cord into your eMac, then plug the other end into an electrical outlet or power strip.
4. Press the power button to restart your computer.

Warning: Never turn on the computer unless all of its internal and external parts are in place and it is closed. Operating the computer when it is open or missing parts can damage your computer or cause injury.



Optional Stand Installation

Tools

- The tool is included with the stand.

To install the eMac (ATI Graphics) stand:

1. Save open documents and quit all open applications.
2. Turn the computer off by choosing Shut Down from the Special menu (if using Mac OS 9), or choose Shut Down from the Apple menu if using OS X.
3. Unplug all cables.
4. Place a soft towel or cloth on the desk or surface.
5. Turn the computer over to access the screw holes on the bottom.



6. The stand attaches to the locations circled below.



7. Remove the screw circled below.



8. Position the stand in place over the screw holes.

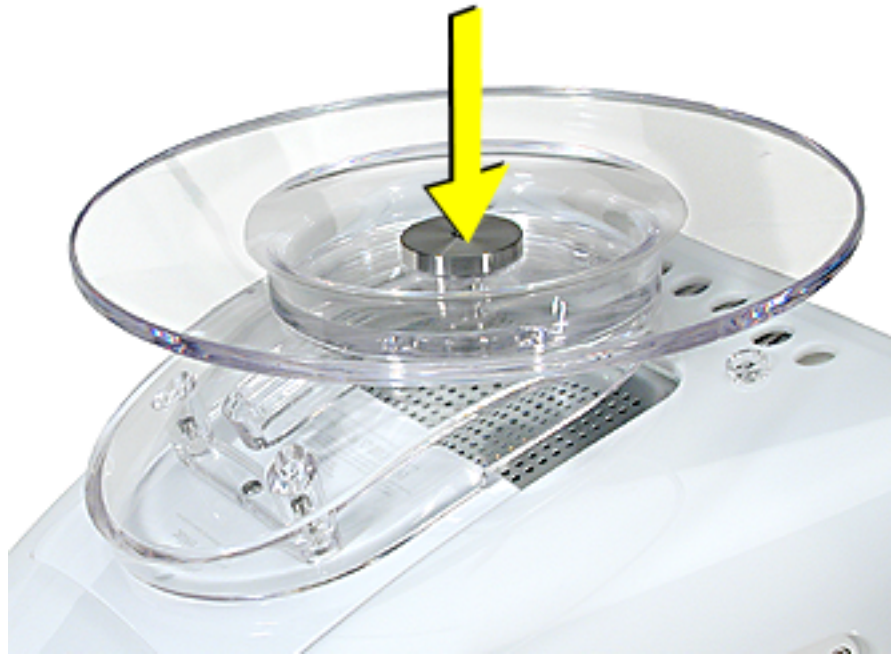

9. **Note:** The stand slides back and forth. To attach the first screw, slide the stand toward the back of the computer.



10. Push the stand forward. Tighten the second screw.



11. Tighten the third screw.



12. Carefully turn the computer over.





AirPort Extreme Card

Tools Required

- #2 Phillips screwdriver.

Opening the AirPort Access Door

1. Save all open documents, quit all open applications, and shut down the computer.
2. Press the optical drive door in on one side and pull the door open on the other side to access the AirPort access panel. (Figure 1)

Figure 1



3. Loosen the captive screws on the AirPort access panel using a Phillips screwdriver. (Figure 2)

Figure 2



4. Remove the access panel.



Removing the Installed Card

1. Untuck the clear plastic tab on the AirPort Extreme card. (Figure 3)

Figure 3



2. Pull the AirPort Extreme card out of the slot a little bit to access the antenna cable. (Figure 4)

Figure 4



3. Disconnect the AirPort Extreme cable from the port on the card, then completely remove the card from the slot. (Figure 5)

Figure 5

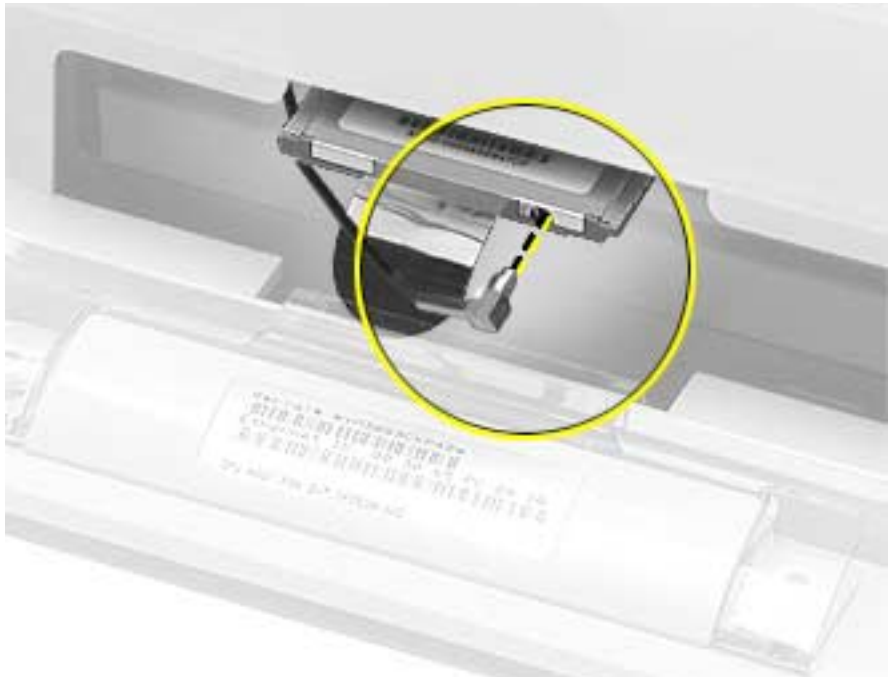

Installing the Replacement Card

1. The original AirPort Card can not be used in this computer. You must use the AirPort Extreme card. (Figure 6)

Note: Previous models of eMac used the original AirPort card. For compatibility information, see AppleCare Knowledge Base article 107440: AirPort Extreme Card: Compatible Macintosh Computers.

Figure 6



2. Insert the AirPort Extreme Card, barcode facing up into the AirPort Extreme card slot. (Figure 7)

Figure 7



3. Attach the antenna cable firmly to the port on the end of the card. (Figure 8)

Figure 8



4. Push the AirPort Extreme card firmly into the slot until you feel the card “snap” into the logic board connector. **Note:** One quick check to identify if the card is properly installed is to check the plastic tab on the card. The edge of the tab should be almost flush (Figure 9) with the face of the bezel. If the card isn't fully snapped in, more of the tab will be easily visible.

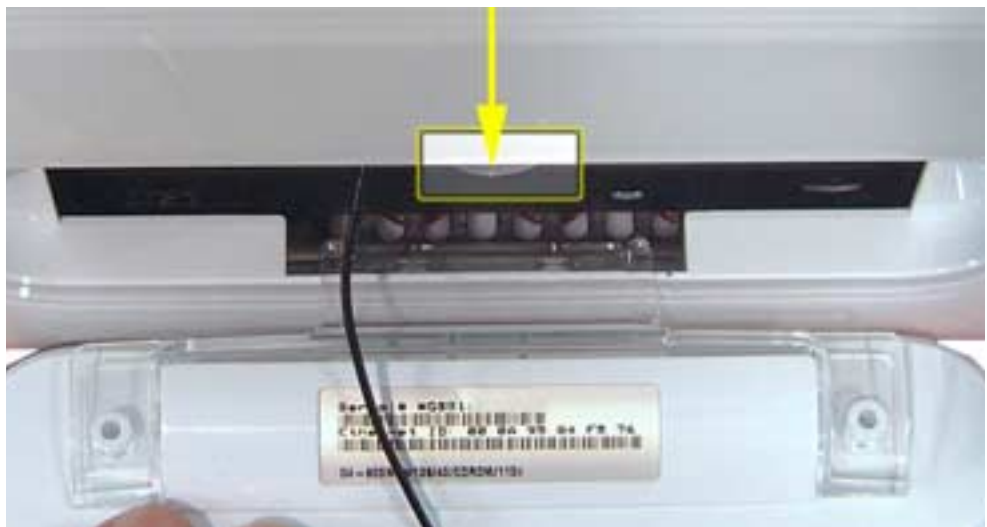

Figure 9

5. Tuck the clear plastic pull-tab on the AirPort Extreme Card into the computer. The tab should tuck over the antenna cable (Figure 10).

Figure 10



Closing the AirPort Access Door

1. Replace the AirPort access panel and tighten the captive screws. (Figure 11)

Figure 11



2. Reconnect the power cable and restart your computer.

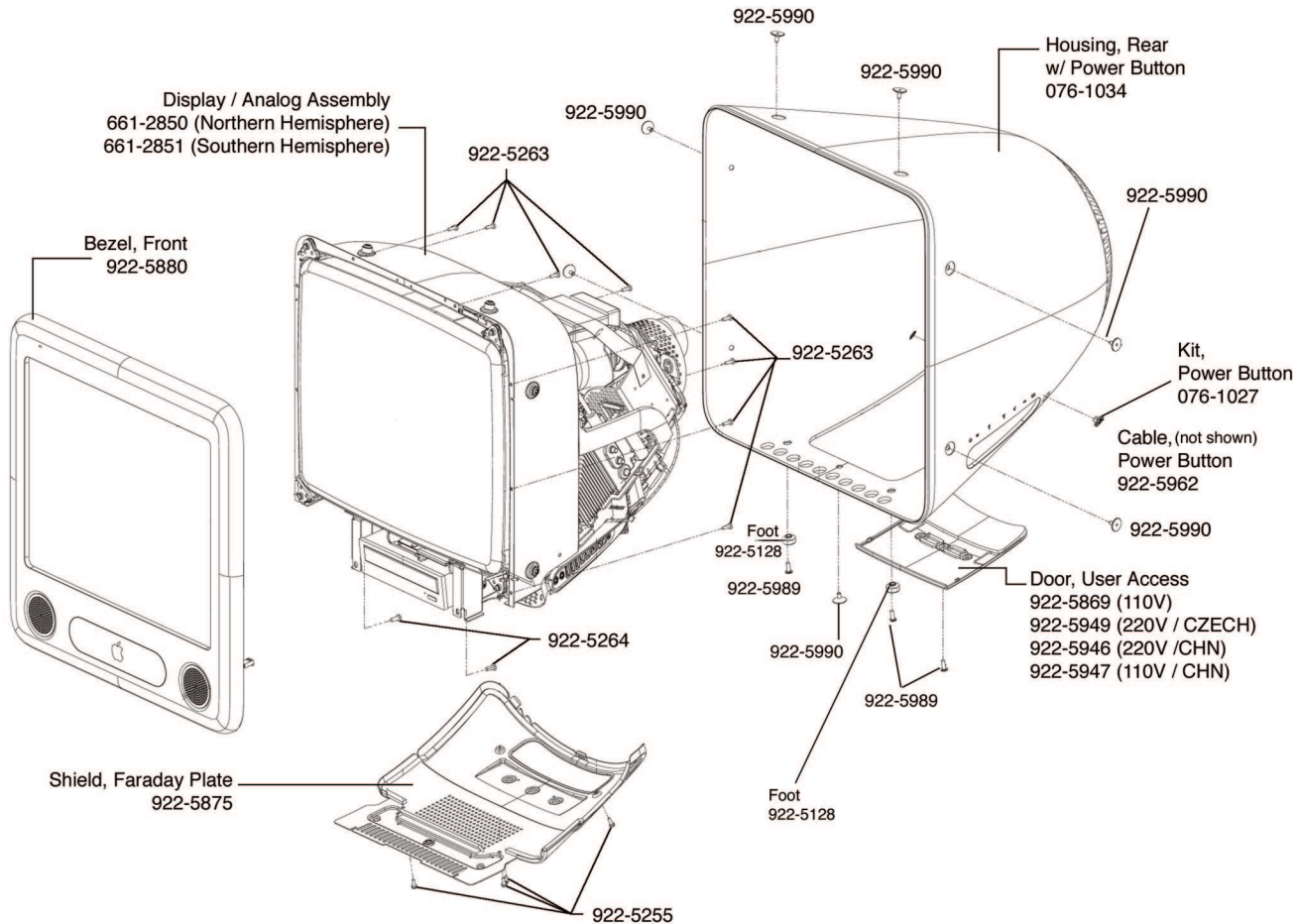

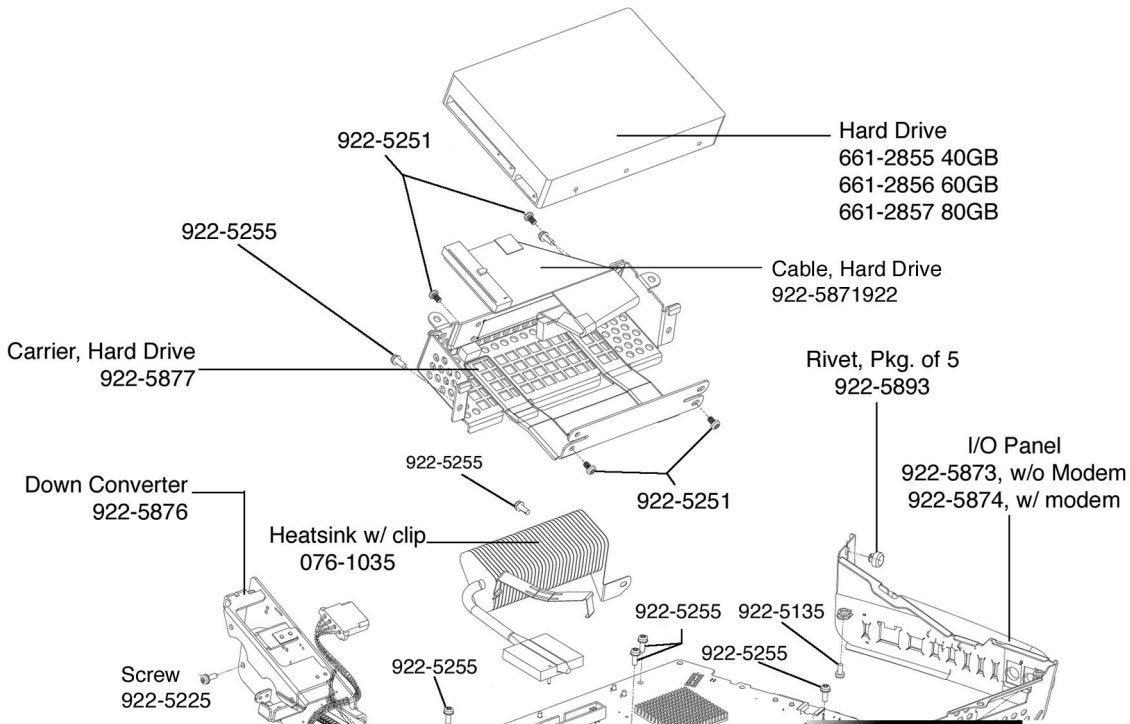

LHR, CRT (International)

922-5864

Display/Analog Assembly

661-2850 (Northern Hemisphere)

661-2851 (Southern Hemisphere)

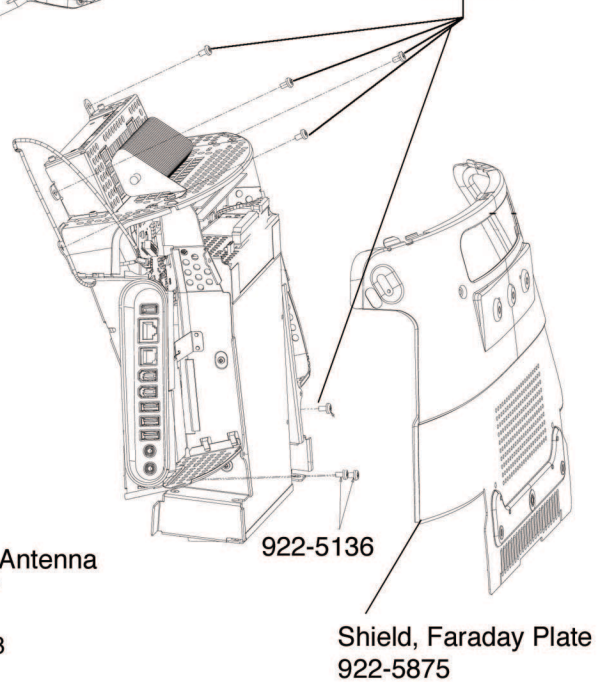
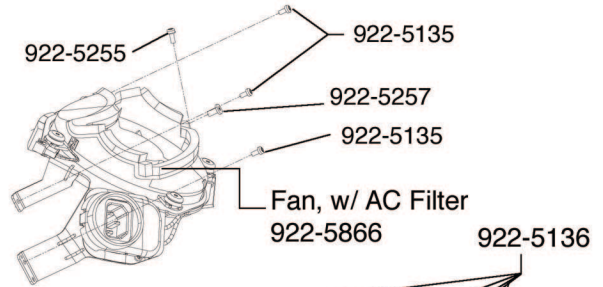
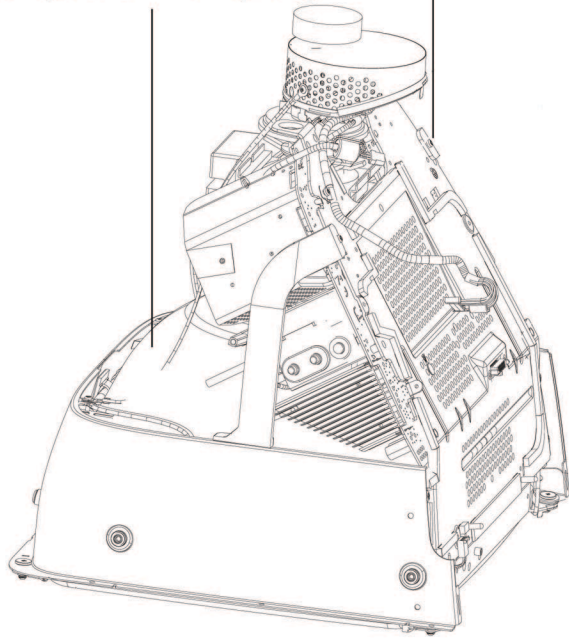

Clips, Antenna

922-5933

Housing, Antenna

922-5867

922-5258

922-5219

Cable, Antenna

922-5865

