

Apple Studio Display 15" LCD
(ADC)





Take Apart
Studio Display 15" LCD (ADC)





Tools

The following tools are recommended for the take apart procedures.

- 2mm hex
- phillips #2 screwdriver
- jeweler's screwdriver set
- ESD wriststrap and mat
- white cotton gloves (922-1592)
- nylon probe tool (922-5065)



Foot Assembly

Tools

This procedure requires the following tools:

- 2mm hex driver
- White gloves for handling plastics

Part Location



Preliminary Steps

Before you begin, do the following:

- Place the computer face down on an ESD mat or soft cloth. **Note:** Plastics are easily damaged. The white gloves prevent fingerprints.

Procedure

1. Remove three screws.



2. Lift the clear hinge cap from the display.





Back Cover

Tools

This procedure requires the following tools:

- 2mm hex driver
- White gloves for handling plastics

Part Location



Preliminary Steps

Before you begin, do the following:

- Place the computer face down on an ESD mat
- Remove the foot assembly

Procedure

1. Remove four T-8 screws on the back cover. Remove the back cover.



2. Lift and remove the inner back cover.

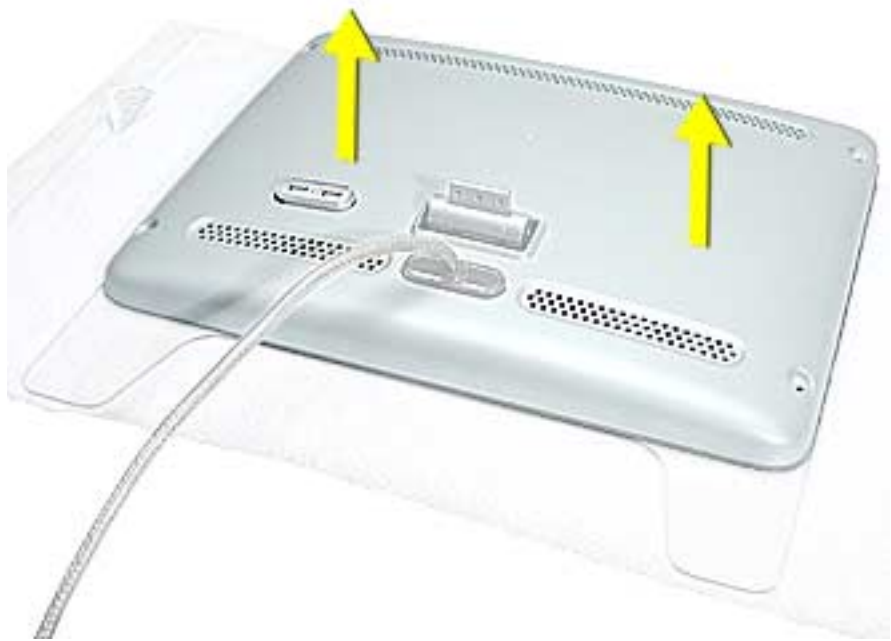



Rear Shield

Tools

- Phillips #2

Part Location



Preliminary Steps

Before you begin, do the following:

- Place the computer face down on an ESD mat
- Remove the foot assembly.
- Remove the back cover and inner rear cover.

Procedure

1. Remove the plastic USB trim ring.



2. Remove three Phillips screws on the shield.

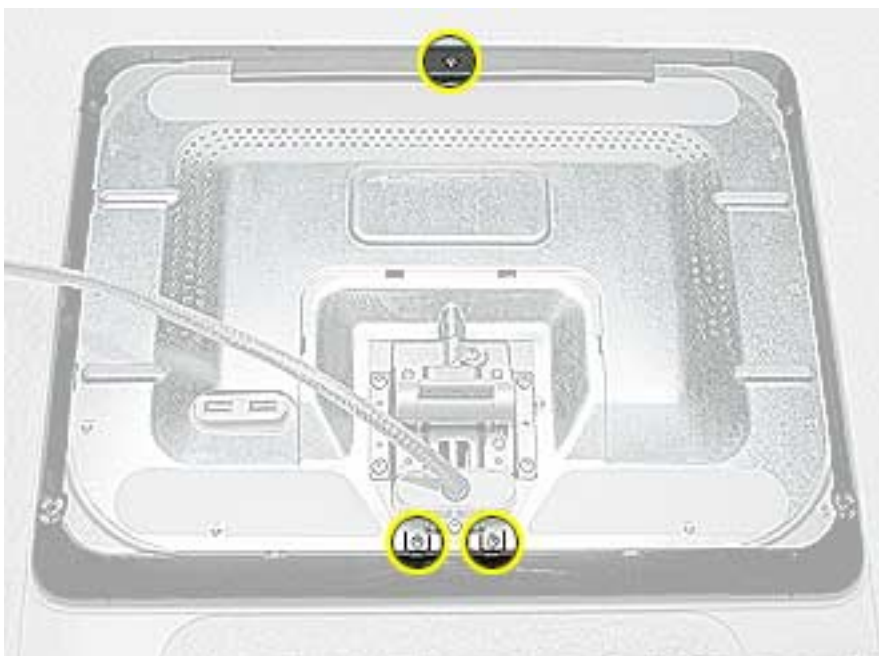

- Slide the shield toward the ADC (Apple Display Connector), unlatching the metal tabs (circled below). **Note:** When reinstalling the metal shield, make sure that the display cables don't get pinched.

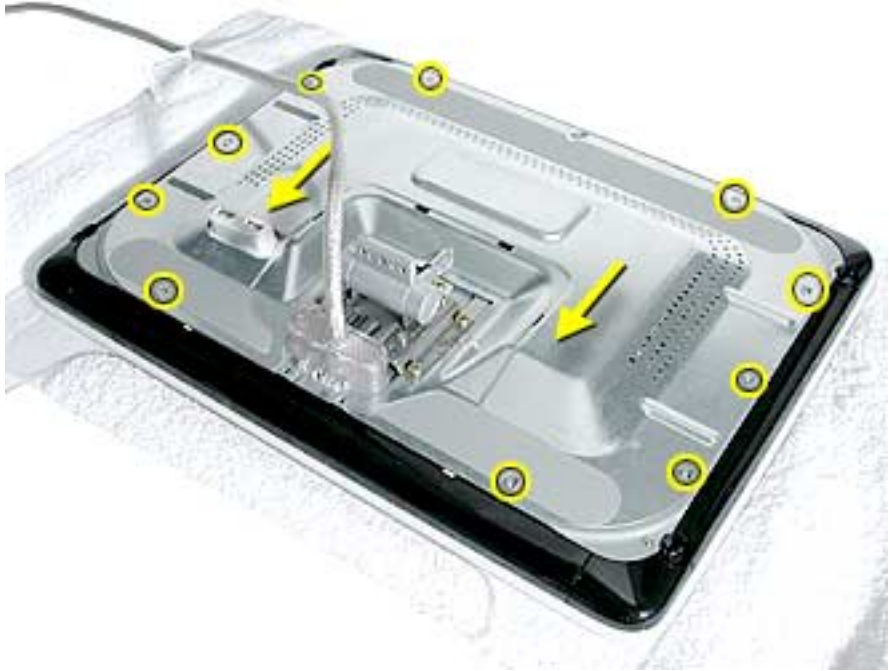

- Lift the shield off the back of the display.



Clips, Horizontal and Vertical

Tools

- Plastic flat blade or similar tool to pry the clips off

Part Location



Preliminary Steps

Before you begin, do the following:

- Place the computer face down on an ESD mat
- Remove the foot assembly.
- Remove the back cover and inner rear cover.
- Remove the rear shield.

Procedure

1. With the plastic flatblade screwdriver, or nylon probe tool (922-5065) pry between the clip and metal chassis to remove the two horizontal and two vertical clips.

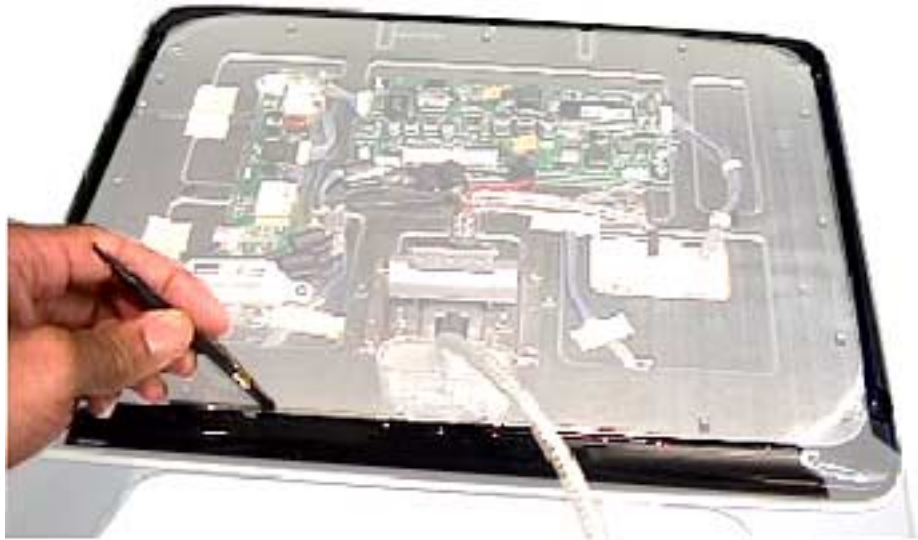



Main PCB

Tools

- Phillips #2

Part Location

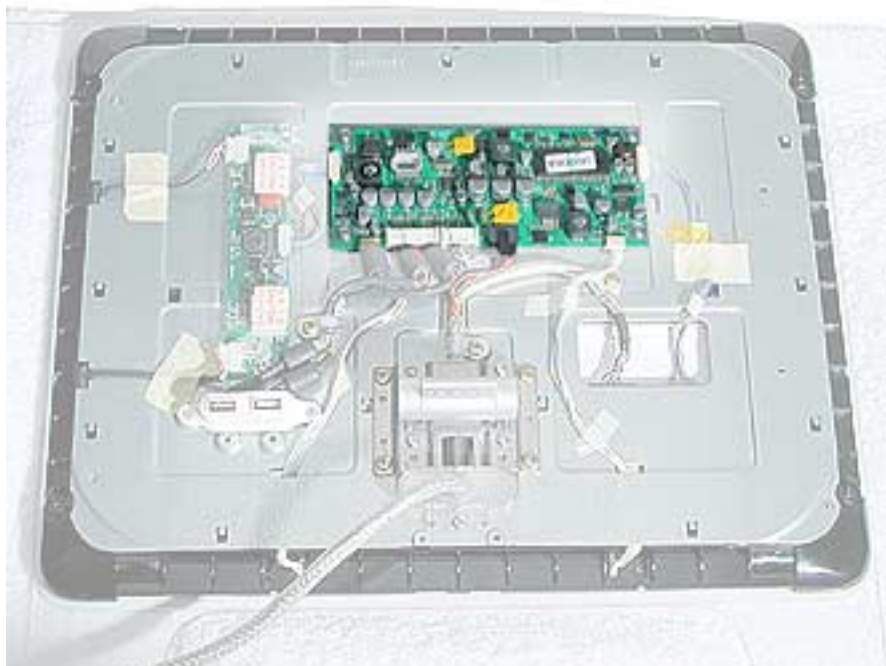

Preliminary Steps

Before you begin, do the following:

- Place the computer face down on an ESD mat
- Remove the foot assembly.
- Remove the back cover and the inner rear cover.
- Remove the rear shield.

Procedure

1. Disconnect the connectors and then remove the four screws. Lift the main board from the chassis.





Inverter

Tools

- Phillips #2

Part Location

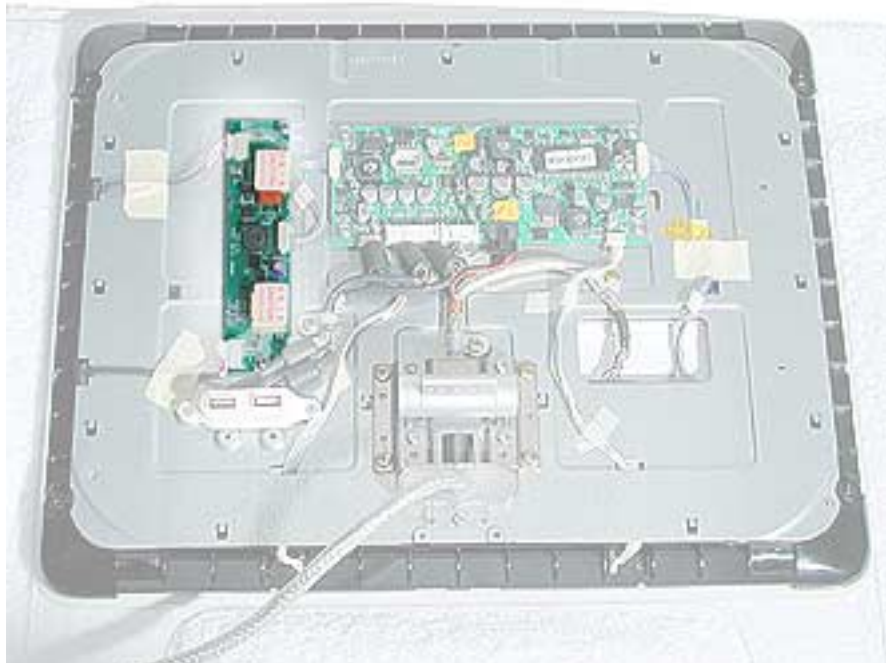

Preliminary Steps

Before you begin, do the following:

- Place the computer face down on an ESD mat
- Remove the foot assembly.
- Remove the back cover and the inner rear cover.
- Remove the rear shield.

Procedure

1. Disconnect three connectors and remove two screws.

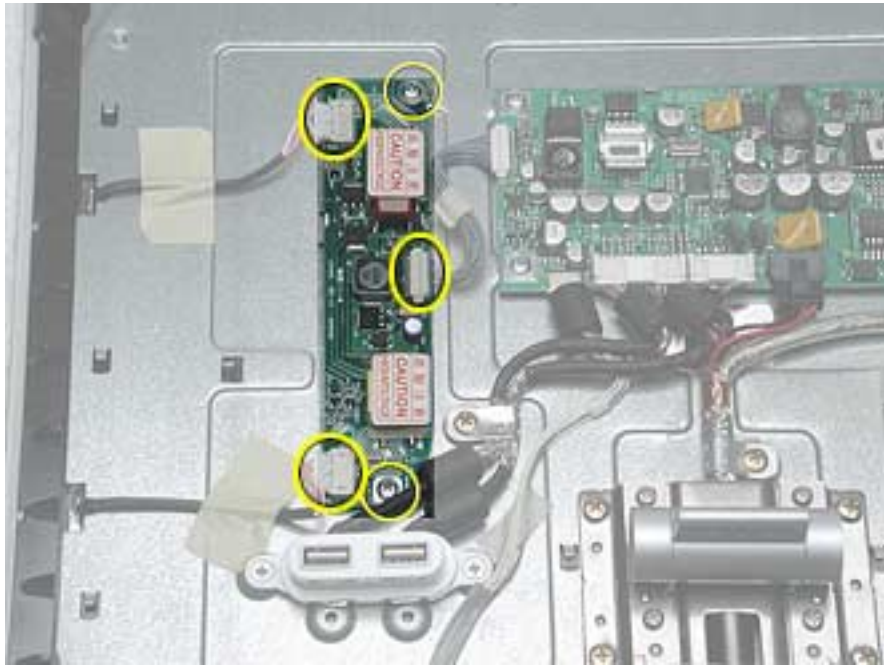

2. Lift the inverter from the chassis.



USB Cable Assembly

Tools

This procedure requires the following tools:

- Phillips #2

Part Location



Preliminary Steps

Before you begin, do the following:

- Place the computer face down on an ESD mat
- Remove the foot assembly.
- Remove the back cover and the inner rear cover.
- Remove the rear shield.

Procedure

1. Disconnect the USB connector on the main board and remove three screws. Lift the cable connector from the chassis.

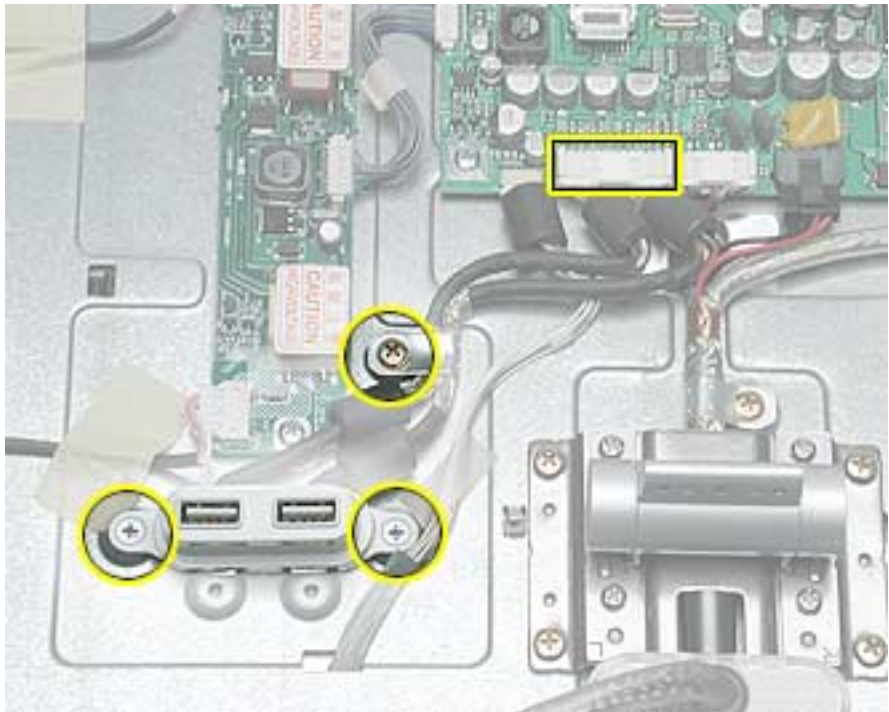



Hinge

Tools

This procedure requires the following tools:

- Phillips #2

Part Location



Preliminary Steps

Before you begin, do the following:

- Place the computer face down on an ESD mat
- Remove the foot assembly.
- Remove the back cover and the inner rear cover.
- Remove the rear shield.

Procedure

1. Remove the four hinge screws.

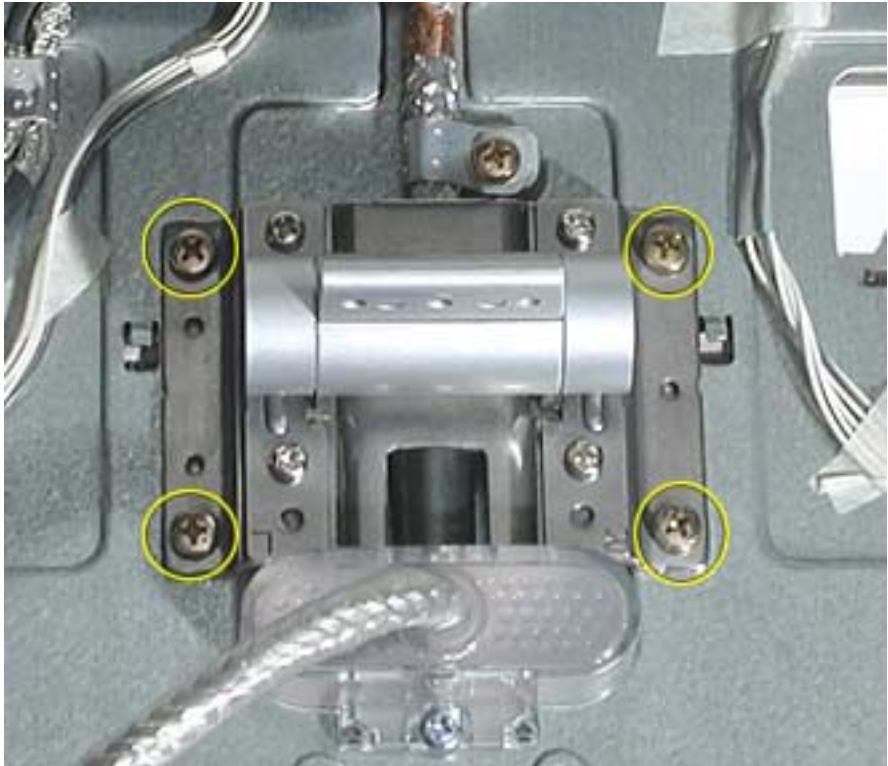

2. Lift the hinge off the chassis.



ADC Cable

Tools

This procedure requires the following tools:

- Phillips #2

Part Location



Preliminary Steps

Before you begin, do the following:

- Place the computer face down on an ESD mat
- Remove the foot assembly.
- Remove the back cover and the inner rear cover.
- Remove the rear shield.
- Remove the hinge.

Procedure

1. Note: The hinge would already be removed.
Disconnect the three ADC cables and remove three screws (one is located toward the bottom of the ADC cable).

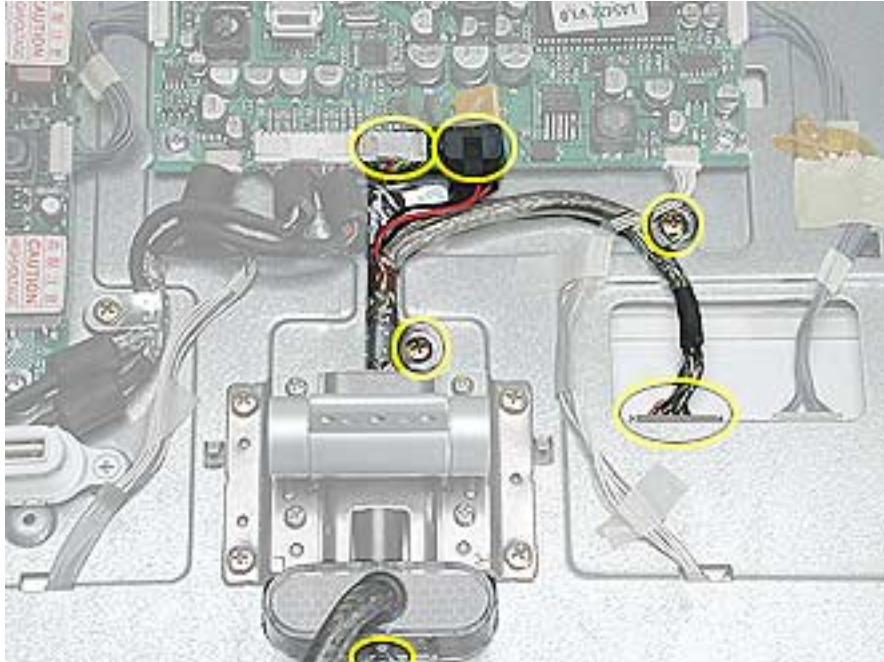

2. Lift the ADC cable off the chassis.



Front Bezel

Tools

This procedure requires the following tools:

- Phillips #2

Part Location



Preliminary Steps

Before you begin, do the following:

- Place the computer face down on an ESD mat or soft cloth. **Note:** Plastics are easily damaged. The white gloves prevent fingerprints.
- Remove the foot assembly.
- Remove the back cover and the inner rear cover.
- Remove the rear shield.

Procedure

1. Lift the chassis and LCD panel off the front bezel.





Touch Switches

Tools

This procedure requires the following tools:

- Phillips #2

Part Location



Preliminary Steps

Before you begin, do the following:

- Place the computer face down on an ESD mat
- Remove the foot assembly.
- Remove the back cover and the inner rear cover.
- Remove the rear shield.
- Remove the horizontal and vertical clips
- Remove front bezel

Procedure

1. Remove the screw on each touch switch.



-
2. Disconnect the touch switches from their cable connectors (two middle circles below). The touch switches rest on the rubber boots (two outer circles below); set them aside so you don't lose them.

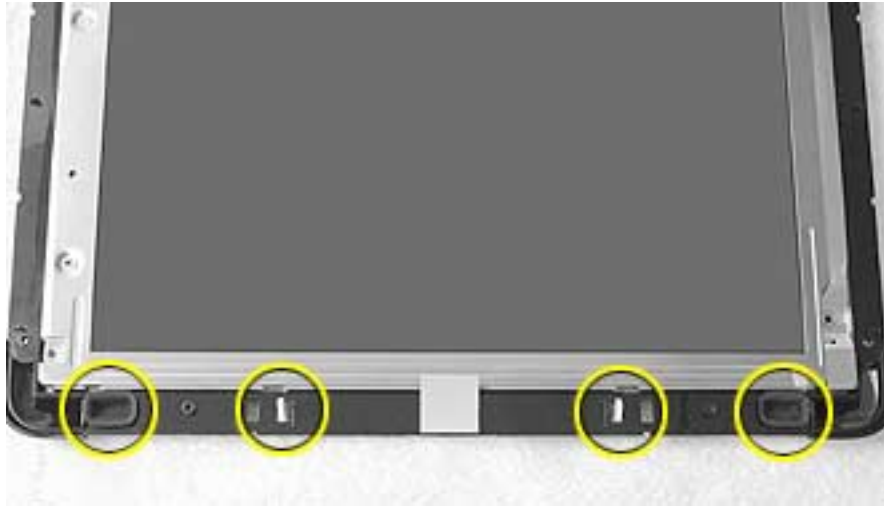



LCD Display

Tools

This procedure requires the following tools:

- Phillips #2

Part Location

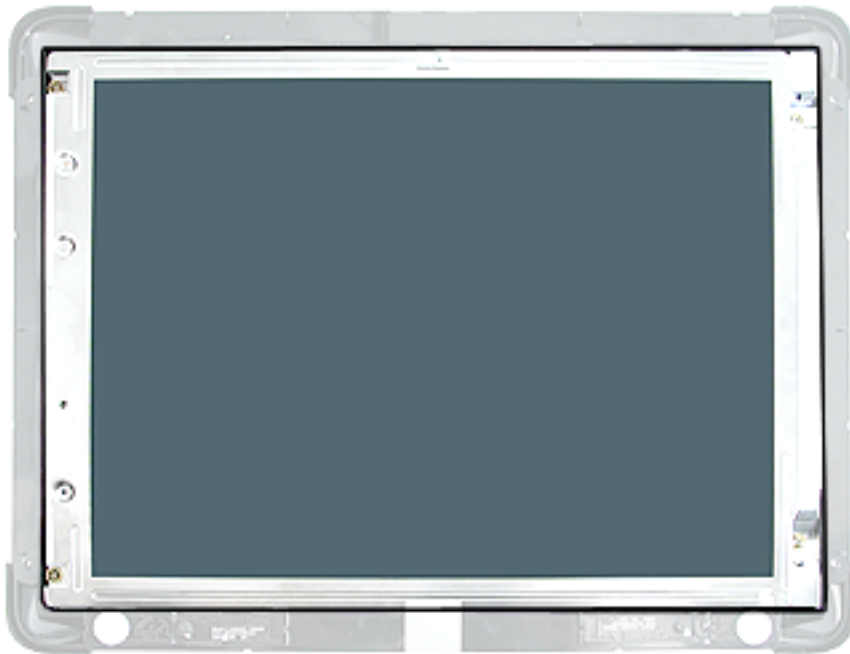

Preliminary Steps

Before you begin, do the following:

- Place the computer face down on an ESD mat
- Remove the foot assembly.
- Remove the back cover and the inner rear cover.
- Remove the rear shield.
- Remove the horizontal and vertical clips.

Procedure

1. Remove four LCD screws. **Replacement Note:** If you are replacing the LCD panel, remove the square piece of gray tape (stuck on the panel between the touch switches) and stick it on the replacement panel. The tape is cosmetic and goes behind the Apple logo in the bezel.



2. Carefully turn the panel over. Disconnect the backlight bulb cables from the inverter board and the touch switch cables from the touch switch boards.

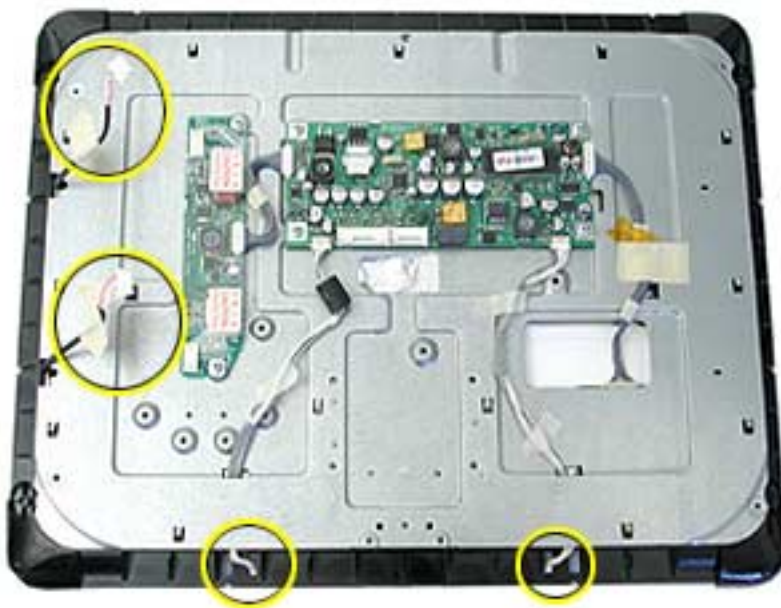

-
3. Separate the metal chassis and black plastic panel cradle to access the backlight cables. Pull the bulb cables through the openings in the plastic cradle.



4. Set the metal chassis and plastic cradle aside.



Bulbs and Bulb Shield

Tools

This procedure requires the following tools:

- Jeweler's screwdriver

Part Location



Preliminary Steps

Before you begin, do the following:

- Place the computer face down on an ESD mat
- Remove the foot assembly.
- Remove the back cover and the inner rear cover.
- Remove the rear shield.
- Remove the horizontal and vertical clips
- Disconnect the touch switches.
- Remove the LCD panel

Procedure

1. Carefully remove the bulb shield from the panel. There are two tabs (located near the arrows below) that hold the shield in place. **Replacement Note:** When replacing the shield be very careful not to pinch the bulb wires on the shield.



2. **Note:** This procedure shows removing both bulbs. Remove the screw (for each bulb) on the back side of the panel. Carefully unhook the bulb cables that are routed through the tab holders **Important:** The bulbs are very delicate and will break if excessive force is applied to the bulb tray.

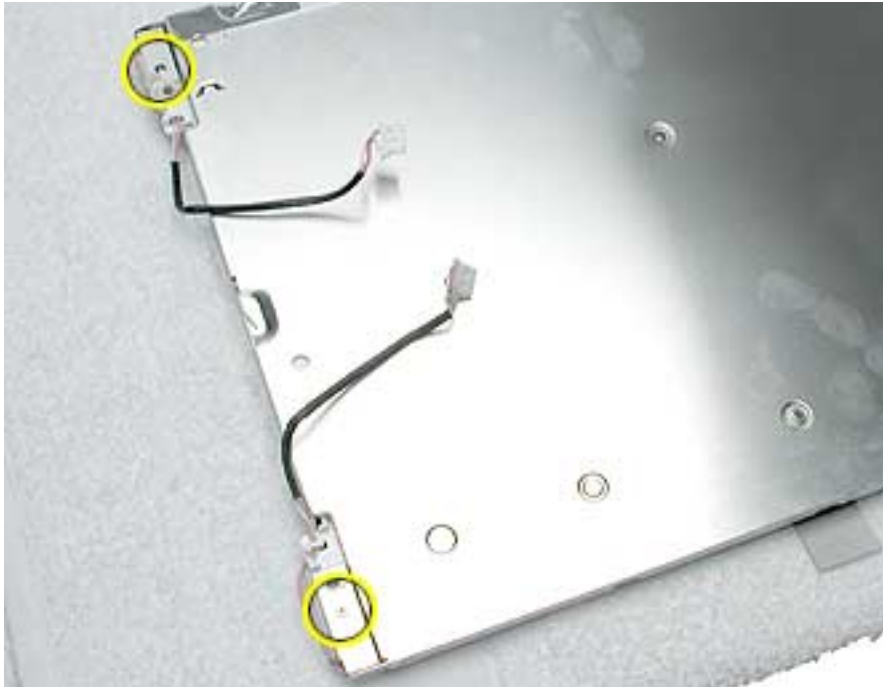

3. Turn the panel over. Remove the screw (for each bulb) on the top side of the LCD panel. **Replacement Note:** Short screws go on the top side, long screws on the back.



-
4. Carefully remove the bulb(s) from the panel. **Note:** Don't touch the bulb.

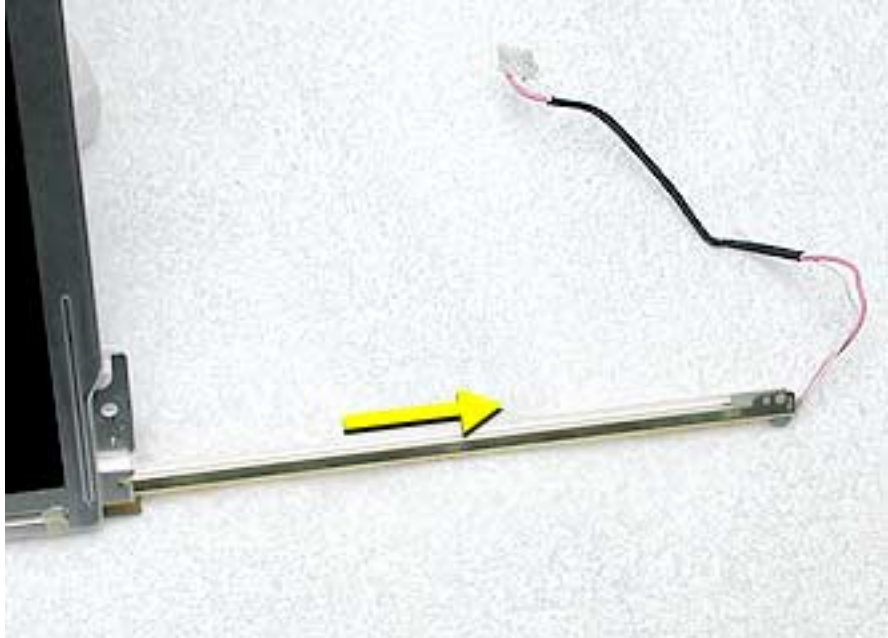



Troubleshooting
Studio Display 15" LCD (ADC)





General Information

1. **ADC Connector and Bent Pins:** Always check for bent pins on the ADC connector and/or the video card before replacing service parts. A damaged ADC connector on the display will ruin any video card it's plugged into (and vice versa). It's important to isolate and repair damaged connectors quickly or risk damaging every display and video card.

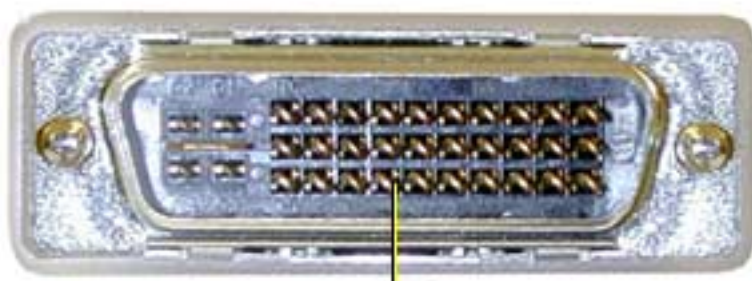

ADC Connector

2. **Touch switches:** The touch switch kit (076-0891) shown below consists of a replacement main board, two touch switches, and touch switch cables. The touch switch kit should only be installed when the customer reports that the display starts up and/ or shuts down intermittently when wireless devices are used in close proximity. The kit also provides users with the ability to disable the touch switches to prevent false activation. The instructions for disabling the touch switches can be found in Knowledge Base article 58813.



Most displays already have the touch switch kit features built in to the display so the touch switch kit is not necessary. However, to determine whether the kit is required, follow the steps below taken from Knowledge Base article 58813.

1. With the system booted and the Studio Display 15 attached, press and hold down the Command and Shift keys, and continue to hold them down while you complete Step 2.
2. Touch the launch button on the left side of the display to open the Displays pane of System Preferences. (You may also open the System Preferences from the Apple menu.)
3. Release the Command and Shift keys.
4. With the Display's system preferences panel open, click the Options tab. **Note:** If the "Options" tab appears, then the touch switch kit is already present. If the Options tab does not appear, and the display is experiencing problems working in close proximity to some wireless devices, the touch switch kit can be installed if necessary.



3. **Main Board Identification:** If the main pcb board shows Rev 1.4 (shown below) on the PCB silkscreen then the touch switch kit features are already present. **Note:** Do not use the V1.0 information printed on the large IC's sticker to identify the board revision; use only the PCB silkscreen number.

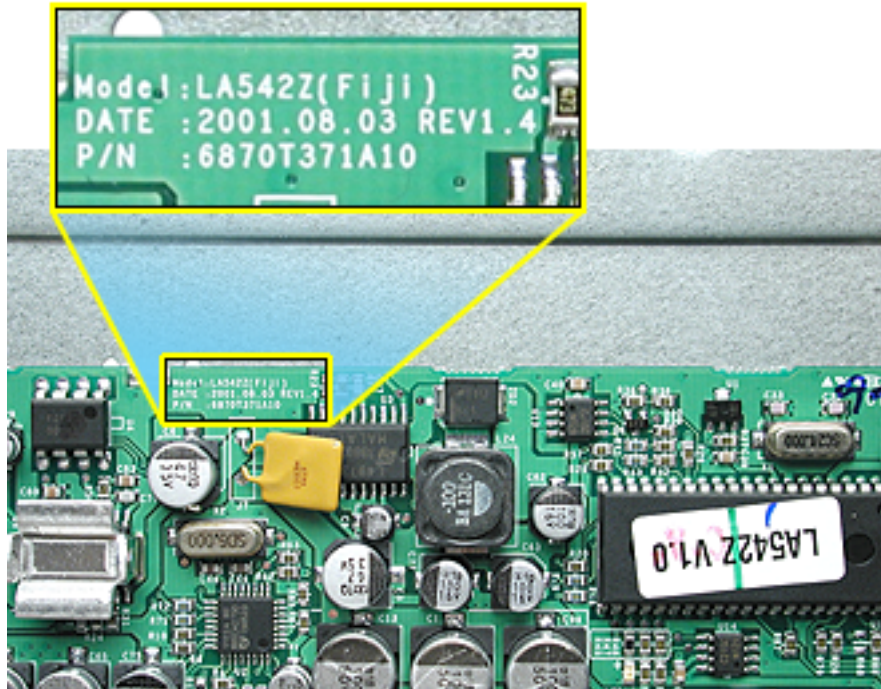

4. **Error codes:** The Studio Display 15 will flash a repeating error code on the power LED if it detects a backlight fault. The error code consists of two short flashes followed by a long flash, a pause, and then the error repeats. When this error condition occurs, the problem could be bad bulbs, disconnected cable, or a bad inverter. Test the bulbs by pulling them out of the display and plugging them directly into the inverter. If they light, the bulbs are good. If they don't light, try a known good bulb and try again. If the bulb still doesn't light, replace the inverter. **Warning:** The inverter board generates high voltage when the display is plugged in. Do not touch the inverter board components, pins or connectors, when the display is connected to the computer.



Symptom Charts

How to Use the Symptom Charts

The Symptom Charts included in this chapter will help you diagnose specific symptoms related to the product. Because cures are listed on the charts in the order of most likely solution, try the cures in the order presented. Verify whether or not the product continues to exhibit the symptom. If the symptom persists, try the next cure.

Note: If you have replaced a module, reinstall the original module before you proceed to the next cure.

No Power

1. Check J4 (see graphic below) input voltage. Do you measure +28V? If yes, go on to the next step. If no, make sure the ADC (Apple Display Cable) cable is securely connected. Disconnect the display cable and check for bent pins on the display cable connector. Look for and carefully straighten any bent pins. Check for bent pins on the video card, straighten any bent pins. Also, verify that you have a known good video card in the computer. Turn on the computer to see if the symptom is gone.

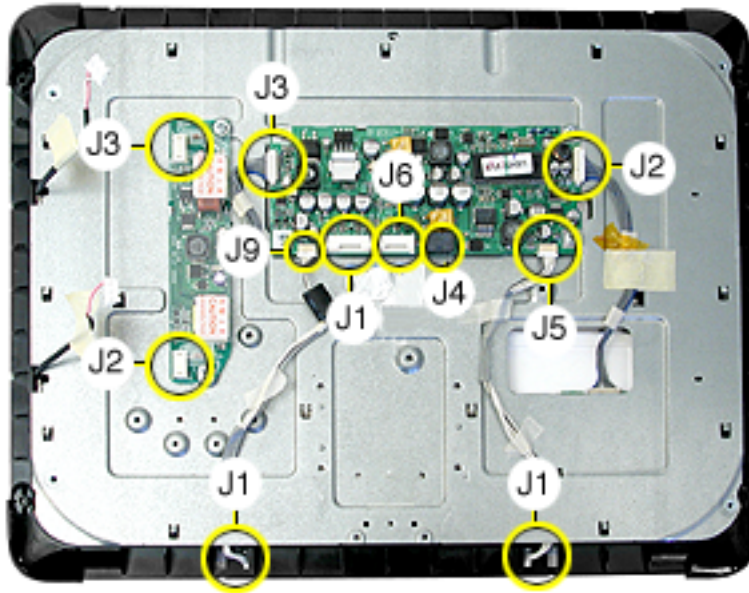

2. Check IC U5 (pin 4) voltage. U5 is located to the right and slightly up (about 1/2") from connector J4. Do you measure +12V? If yes, go on to the next step. If no, replace the main board.
3. Check that the power button (touch switch) is working. Verify that the pins are not bent on the touch switch. Refer to Knowledgebase article 58813 to determine whether the touch switches have been software disabled. Reseat the connector at J9. If the power button touch switch is ok, go on to the next step. If you still have no power, replace the power button (touch switch).
4. If you still have no power, recheck the ADC cable for bent pins, verify the connections to the main board (J2, J4, J6).
5. Replace the main board.

No Video

Dark Screen

1. Connect the display to a working computer. Shine a bright light onto the LCD to see if a faint image is visible. If the backlighting system is not functioning (and for some reason there is no diagnostic code on the LED) then the bright light should reveal a faint image of the desktop (or whatever is being displayed at the time). Do you see a faint image? If yes, replace the backlight bulb(s). If you don't see a faint image, go on to the next step. **Note:** A high intensity light generates heat which could damage the LCD display if left on for too long. Use caution to prevent damage to the LCD.
2. Check J3 (on the main board), pins 1 and 2 for +12V. Do you measure +12V? If yes, go on to the next step. If no, replace the main board.

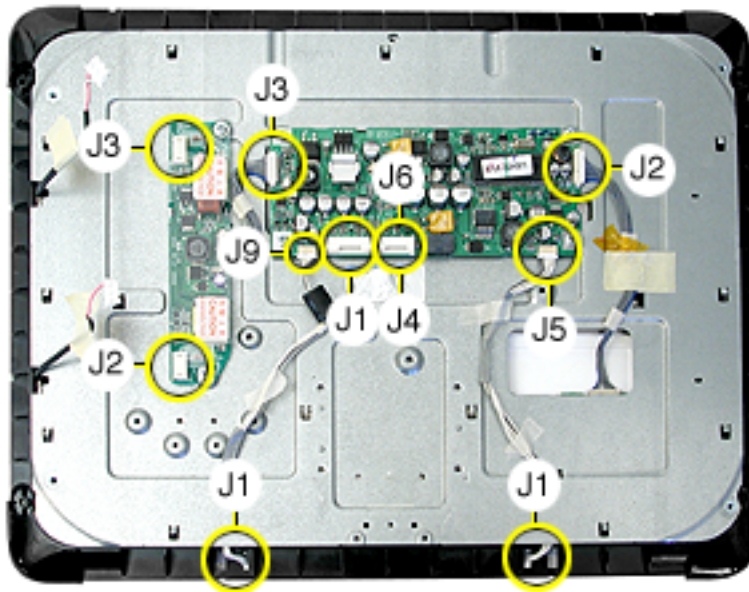

3. Check the inverter board connections. Reseat the connectors. If you still have no video, replace the inverter board.
4. Check the connections on the ADC cable and TMDS connector (cable that connects to the flat panel display). Reseat the connectors.
5. Check the connection on the main board cable at J2. This cable connects to the flat panel. Reseat the cables.
6. Replace the LCD display.

Partially Dim Screen

1. Plug the display into a known-good computer with a known-good video card and ADC display port. Boot the computer.
2. The Studio Display 15 will flash a repeating error code on the power LED if it detects a backlight fault. The error code consists of two short flashes followed by a long flash, a pause, and then the error repeats. When this error condition occurs, the problem could be bad bulbs, disconnected cable, or a bad inverter. Test the bulbs by pulling them out of the display and plugging them directly into the inverter. If they light, the bulbs are good. If they don't light, try a known good bulb and try again. If the bulb still doesn't light, replace the inverter. **Warning:** The inverter board generates high voltage when the display is plugged in. Do not touch the inverter board components, pins or connectors, when the display is connected to the computer.

Touch Switch Not Working

1. Check if the touch switch is disabled (refer to Kbase article 58813).



2. Check the ADC cable. Replace/repair the ADC cable. Check the video card and ADC connector for damage (bent pins).
3. Check the touch switches. The touch switches could be faulty (rare) or the touch switch cable(s) are disconnected. Check the cables and touch switch and replace as needed. Usually if only one touch switch is bad it's probably the associated cable or touch switch. If neither touch switch works, it's probably the ADC cable or the main board having USB problems.
4. The USB circuit on the main board might be faulty. Use the Apple System Profiler to determine if the display's hub and the display are visible. If not, replace the main board.

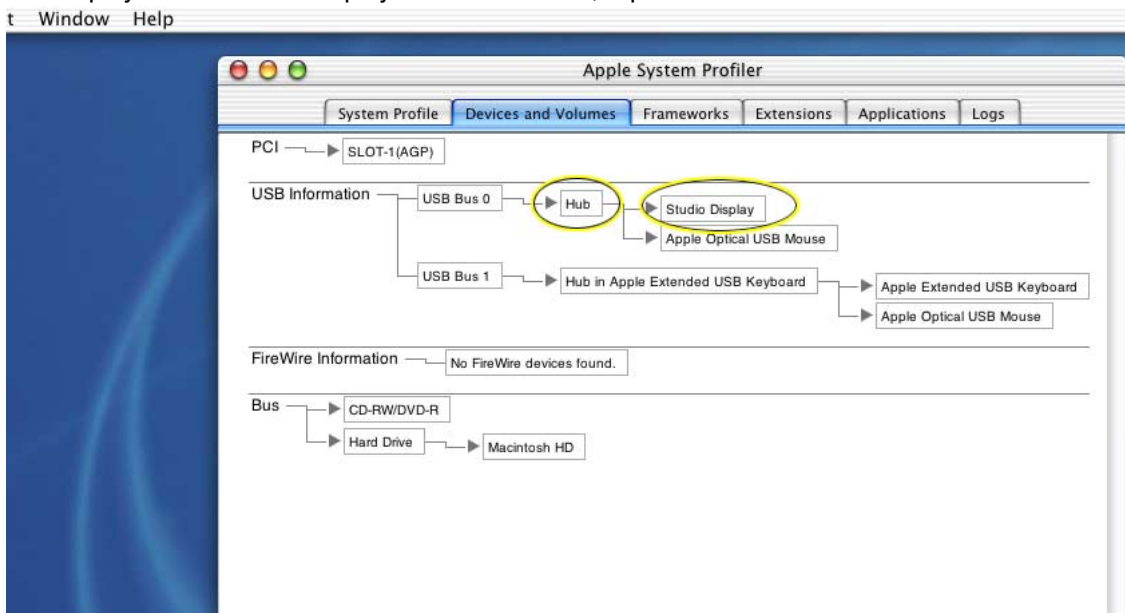

USB Devices Connected to Display Hub Not Working

1. Test the USB ports. Connect another USB device to one of the display's USB ports. Use the Apple System Profiler to determine if the display's hub and the display are visible.
2. Does Apple System Profiler see the USB device you connected? If the hub shows up, but the attached USB devices don't, check the USB cable and its connectors that attach to the main board. If the hub or attached devices don't show up, there could be a problem with the ADC display cable (bent pins at the ADC connector). If the problem still exists, go on to the next step.

Edit Window Help

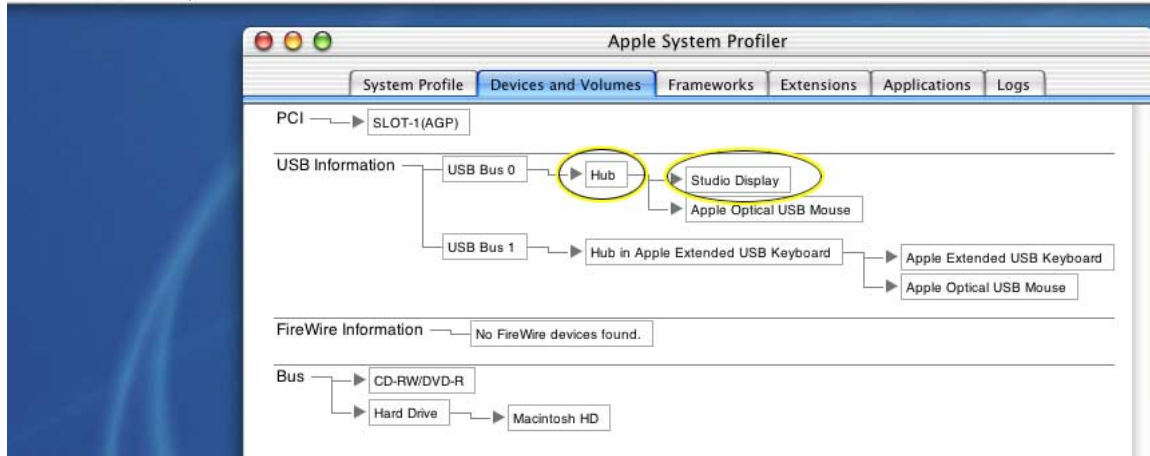

3. Check connector J6 (on the main board). Make sure it's connected and there are no bent pins.

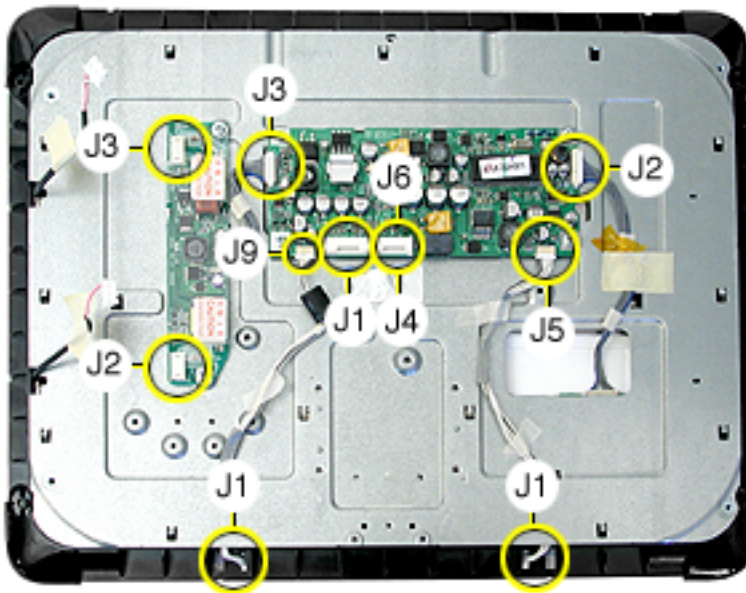

4. Check Apple System Profiler again. Verify if the display's USB hub is visible. If no, replace the main board or replace the Apple Display Cable.

Pixel Anomalies

Note: Refer to KnowledgeBase article 22194 for the most current Pixel Anomaly information and specifications.

Article 22194 defines the term “pixel anomaly”, explains why such anomalies occur, and describes what to do if you feel your active matrix LCD panel has more than an acceptable number of pixel anomalies.



Views

Apple Studio Display 15" LDC (ADC)

Exploded View

