

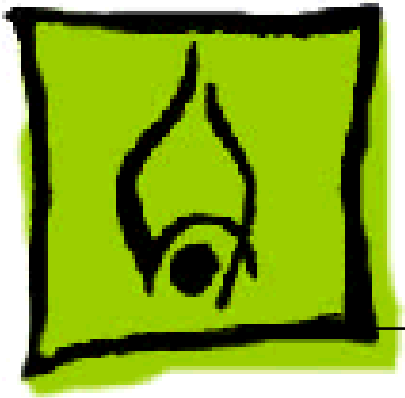

17" ColorSync Displays

- 17" ColorSync Display (was AppleVision 750)
- 17" ColorSync AV Display (was AppleVision 750AV)





Hot Issues

17" ColorSync Displays
(AppleVision 750, 750AV)





Overview

This chapter is designed to highlight unique or high-priority product issues that you should be aware of before servicing this display.

This chapter alerts you to important issues and provides links to other areas in the manual where more complete information can be found. This chapter is not intended to replace other parts of this manual; it merely provides a pointer to pertinent information in those chapters.

The date the Hot Issue was published is indicated in parentheses after the title.





Revised Troubleshooting Chapter Features CRT/Video Board Procedures (3/98)

The Troubleshooting chapter has been revised to include procedures for downloading setup parameters, adjusting the display after replacing the CRT/video board or the main deflection board, and diagnosing suspected hardware problems.

The latest version of the Diagnostics utility called Display Service Utility (v4.2.1) enables service providers to more accurately determine the source of hardware problems and readily repair the display.

The CRT/video board (Apple part number 661-1373) is now offered worldwide as a replacement module. Refer to the





expanded Troubleshooting chapter for the latest troubleshooting procedures; refer to the Diagnostics site of Service Source Online or the Service Source Companion CD (Diagnostic Utilities folder) for the Display Service Utility v4.2.1.





Jittery or Blurry Video with Power Macintosh 5500/6500 (12/97)

If the display exhibits jittery or blurry video when connected to a Power Macintosh 5500 or 6500, suspect the computer, not the monitor.

Video jitter affects monitors connected to computers having a 225 or 250 MHz logic board. Jitter is evident where the pixels shimmer or jump at the edges of the screen, windows, or dialog boxes.

Blurry video is seen as a fuzzy image over the entire screen on monitors set to resolutions of 832x624 and higher.





Identifying Suspect Units

Video jitter or blurry video can be caused by Power Macintosh computers within the following serial number ranges.

Video Jitter

- PM 5500 from TY705xxxxx to TY715xxxxx
- PM 6500 from XB708xxxxx to XB718xxxxx

Blurry Video

- PM 6500 from XB708xxxxx to XB723xxxxx

The system software on Power Macintosh 6500 computers allows selecting monitor resolutions above 1152x870. But these higher resolutions are not supported and cause poor video output, such as misaligned or skewed video, low brightness, blurriness, and so on. Monitors connected to





Power Macintosh 6500 computers should not be set to resolutions higher than 1152x870.

Check the Monitors & Sound control panel to make sure the resolution is set to 1152x870 or lower. For a chart of supported monitor resolutions for the Power Macintosh 6500, see the Specifications chapter in the Performa/Power Macintosh 6400 and 6500 Series manual on Service Source.

Although these symptoms have never been reported for a Power Macintosh 5500, the 225 MHz logic board used in the Power Macintosh 6500 is also used in the 5500. Refer to the Troubleshooting chapter in Service Source for both Power Macintosh manuals.





Basics

17" ColorSync Displays
(AppleVision 750, 750AV)





Product Name Change

The AppleVision 750 and 750AV Displays were renamed in November, 1997.

Original Name	New Name
AppleVision 750 Display	17" (16.1" VIS) ColorSync Display
AppleVision 750AV Display	17" (16.1" VIS) ColorSync AV Display

Although the body of this service manual retains the AppleVision names, both names are shown on the title page of each chapter. The ColorSync name change was the only change to the product.

Note: VIS represents the diagonal viewable image size of the display.





Product Overview

The AppleVision 750AV Display is a full-page, Trinitron color monitor that supports a variety of resolutions. The display includes sound and video support for multimedia application programs and advanced controls for accurate color rendering.

The AppleVision 750AV Display has a diagonal viewable image size of 16.1 inches.





The AppleVision 750AV Display works with both Mac OS-based and Windows-based computers.

Features

The AppleVision 750AV Display features

- A wide range of screen resolutions (from 640x480 to 1280x1024)
- A tilt/swivel base that allows the monitor to be positioned for optimal viewing comfort
- Integrated speaker enclosure and voice recognition-capable microphone
- Energy Star Power Conservation compliance
- TCO 92 compliance

Except for the speaker enclosure and microphone, the AppleVision 750 Display shares the same features as the AppleVision 750AV Display.





Repair Issue: Display Service Utility



Display Service Utility

The Display Service Utility (on the Service Source Companion CD: Diagnostic Utilities folder) is an application that you can use to display video test patterns, run some troubleshooting procedures, and adjust geometry.



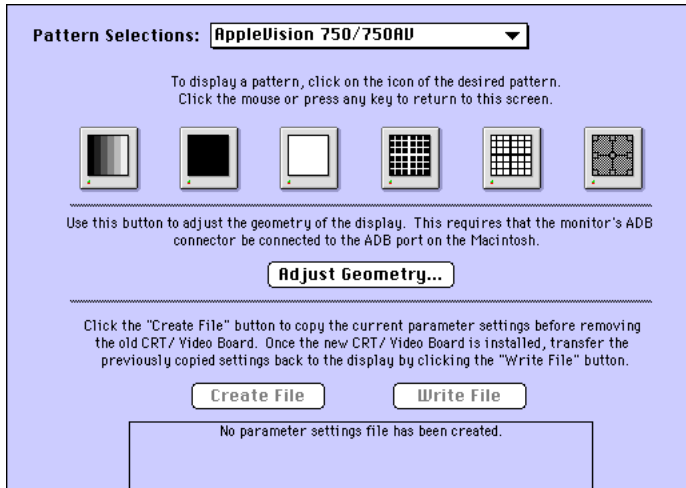

A selection for the AppleVision 750/750AV was added to the latest version of the Display Service Utility on the Service Source Companion CD and Service Source Online. Within the Display Service Utility, select Pattern Selections: AppleVision 750/750AV, and click the Adjust Geometry button.

Clicking the Adjust Geometry button opens a screen of scroll bars that you can use to make various





geometry adjustments. Although most of these adjustments can be duplicated by using the Monitors & Sound control panel, high voltage can only be adjusted with the Display Service Utility.

Refer to the Read Me document in the Display Service Utility folder for more information.

For more information on using the Display Service Utility for troubleshooting or adjusting the AppleVision 750 and 750AV displays, refer to the Troubleshooting chapter in this manual.





Repair Issue: TCO 95 Housing

Effective January 1998, TCO 95 plastics are used for the 17" ColorSync Display (but not the AV version). The higher environmental rating of plastics is used for the following housing parts:

- 076-0723 ADB Board Panel, TCO 95
- 922-3335 Front Bezel, TCO 95
- 922-3338 Rear Housing, TCO 95
- 922-3343 Bottom Housing, TCO 95
- 922-3387 Blank Plate, TCO 95

Important: ColorSync displays using TCO 95 plastics can be identified by the TCO 95 marking on the back of the rear housing. Replace TCO 95 housing parts like-for-like. Do not substitute with TCO 92 parts.





Specifications

17" ColorSync Displays
(AppleVision 750, 750AV)





Introduction

Specifications information for this product can be found in this chapter and also in the Spec Database, which you can access in one of three ways:

- Launch it directly by double-clicking the Apple Spec Database runtime alias at the top level of the Main Service Source CD.
- Select “Apple Spec Database” from the Service Source drop-down main menu.
- Click the Acrobat toolbar icon for the database, which is near the right end of the toolbar with the letters “SP.”





Characteristics

Picture Tube

17-in. Trinitron CRT (16.1-in. diagonal viewable image)
Multiple scan, antistatic, antiglare surface treatment
0.26-mm stripe pitch

Screen Resolution

640x480 at 60 Hz in VGA mode
640x480 at 66.67 Hz in Macintosh mode
800x600 at 60.31 Hz in VESA mode
800x600 at 75 Hz in VESA mode
832x624 at 74.55 Hz in Macintosh mode
1024x768 at 74.93 Hz in Macintosh mode
1024x768 at 60 Hz in VESA mode
1152x870 at 75 Hz in Macintosh mode
1280x1024 at 60 Hz in VESA mode
1280x1024 at 75.03 Hz in VESA mode



**Scan Rates**

Vertical refresh rate: 40–120 Hz
Horizontal scan rate: 30–80 kHz

Cable Connector

15-pin miniature D-type

Input Signals

Red, green, and blue signals; separate sync





System Requirements

System software version 7.1 or later

Computers with 68040 microprocessors or later

AppleVision software is supported by the following computers:

PCI CPUs: 7200, 7500, 7600, 8500, 9500, 6360, 6400,
6500, 7300, 8600, 9600 or later CPUs

PowerMac CPUs: 8100/100, 8100/80AV, 7100/80, 6100/
66, 6100/60AV, 6200, 6300

PowerBooks: 280c & 2300/Mini Dock/Duo Dock II, 540c,
5300, 1400, and 3400

Quadra CPUs: Q605, Q610, Q630, Q630/PowerMac Upgrade,
C650, Q650, Q650/STP, Q950, Q950/STP, 660AV, 840AV

Apple DOS-compatible CPUs: Q610/DOS, 6100/DOS, 640
DOS, PC-compatible Pentium 100 MHz and 586 Pentium
100 MHz PC cards on PCI CPUs.





Monitor Timings

640x480
Resolution @ 60 Hz

Horizontal Timing
1/H: 31.5 kHz
Back Porch: 48 dots
H SYNC: 96 dots
Front Porch: 16 dots
1 H: 31.75 μ s
1/dot: 25.175 MHz

Vertical Timing
1 V: 16.7 ms
Back Porch: 33 H
V SYNC: 2 H
Front Porch: 10 H

640x480
Resolution @ 66.67 Hz

Horizontal Timing
1/H: 34.97 kHz
Back Porch: 96 dots
H SYNC: 64 dots
Front Porch: 64 dots
1 H: 28.0 μ s
1/dot: 30.24 MHz

Vertical Timing
1 V: 15.0 ms
Back Porch: 39 H
V SYNC: 3 H
Front Porch: 3 H





Monitor Timings

800x600
Resolution @ 60.31 Hz

Horizontal Timing
1/H: 37.9 kHz
Back Porch: 88 dots
H SYNC: 128 dots
Front Porch: 40 dots
1 H: 27.85 μ s
1/dot: 40.000 MHz

Vertical Timing
1 V: 16.58 ms
Back Porch: 22 H
V SYNC: 4 H
Front Porch: 2 H

800x600
Resolution @ 75 Hz

Horizontal Timing
1/H: 46.9 kHz
Back Porch: 160 dots
H SYNC: 80 dots
Front Porch: 16 dots
1 H: 21.33 μ s
1/dot: 49.5 MHz

Vertical Timing
1 V: 13.33 ms
Back Porch: 21 H
V SYNC: 3 H
Front Porch: 1 H





Monitor Timings

832x624
Resolution @ 74.55 Hz

Horizontal Timing
1/H: 49.7 kHz
Back Porch: 224 dots
H SYNC: 64 dots
Front Porch: 32 dots
1 H: 20.1 μ s
1/dot: 57.28 MHz

Vertical Timing
1 V: 13.41 ms
Back Porch: 38 H
V SYNC: 3 H
Front Porch: 2 H

1024x768
Resolution @ 74.93 Hz

Horizontal Timing
1/H: 60.24 kHz
Back Porch: 176 dots
H SYNC: 96 dots
Front Porch: 32 dots
1 H: 16.6 μ s
1/dot: 80 MHz

Vertical Timing
1 V: 13.35 ms
Back Porch: 30 H
V SYNC: 3 H
Front Porch: 3 H





Monitor Timings

1024x768
Resolution @ 60 Hz

Horizontal Timing
1/H: 48.4 kHz
Back Porch: 160 dots
H SYNC: 136 dots
Front Porch: 24 dots
1 H: 20.68 μ s
1/dot: 65.0 MHz

Vertical Timing
1 V: 16.66 ms
Back Porch: 29 H
V SYNC: 6 H
Front Porch: 3 H

1152x870
Resolution @ 75 Hz

Horizontal Timing
1/H: 68.681 kHz
Back Porch: 144 dots
H SYNC: 128 dots
Front Porch: 32 dots
1 H: 14.56 μ s
1/dot: 100.00 MHz

Vertical Timing
1 V: 13.3 ms
Back Porch: 39 H
V SYNC: 3 H
Front Porch: 3 H





Monitor Timings

1280x1024
Resolution @ 60 Hz

Horizontal Timing
1/H: 63.8 kHz
Back Porch: 272 dots
H SYNC: 112 dots
Front Porch: 16 dots
1 H: 15.23 μ s
1/dot: 110.25 MHz

Vertical Timing
1 V: 16.66 ms
Back Porch: 39 H
V SYNC: 3 H
Front Porch: 1 H

1280x1024
Resolution @ 75.03 Hz

Horizontal Timing
1/H: 79.976 kHz
Back Porch: 248 dots
H SYNC: 144 dots
Front Porch: 16 dots
1 H: 12.5 μ s
1/dot: 135 MHz

Vertical Timing
1 V: 13.33 ms
Back Porch: 38 H
V SYNC: 3 H
Front Porch: 1 H





Speakers (750AV only)

Stereo, with ported (bass reflex) chamber design
Maximum loudness: 92 dB SPL at 1 kHz at 0.5 meters
Frequency response: 70 Hz to 20 kHz \pm 6 dB

Audio input signal: Accepts audio signal of up to 4 Vpp (line level-low sensitivity) or as low as 20 mVpp (microphone level-high sensitivity)

Internal speaker muted when headphones are inserted into the headphone port





Controls and Ports

User Controls

Front panel (750AV): power, brightness, contrast, bass, treble, microphone on, volume, mute, and three on-screen control buttons

Front panel (750): power, brightness, contrast, and three on-screen control buttons

Additional picture and sound controls available using the Monitors & Sound control panel (Mac OS-based computers) or on-screen controls (Windows-based computers)

Automatic degauss at power-on; manual degauss by turning power switch off, then on





I/O Ports

Apple Desktop Bus (ADB): Two pass-through output ports

Headphone/Speaker (750AV): One audio output port and two built-in speakers

Microphone (750AV): One input port and one built-in microphone





Physical and Electrical

Power Supply

Voltage: 100–120 VAC; 220–240 VAC

Frequency: 50–60 Hz

Power (750): 130 W maximum

Power (750AV): 190 W maximum

Size and Weight (750)

Height: 16.6 in. (425 mm)

Width: 16.0 in. (410 mm)

Depth: 17.7 in. (455 mm)

Weight: 50 lb. (22.5 kg)

Size and Weight (750AV)

Height: 18.8 in. (485 mm)

Width: 16.0 in. (410 mm)

Depth: 18.8 in. (485 mm)

Weight: 60 lb. (27 kg)





Environmental

Temperature

Operating: 50°F to 104°F (10°C to 40°C)

Shipping: -4°F to +140°F (-40°C to +60°C)

Storage: 32°F to 140°F (0°C to 60°C)

Humidity

Operating: 10% to 80%, noncondensing

Shipping: 5% to 90%, noncondensing

Storage: 5% to 90%, noncondensing

Altitude

Operating: 0 to 10,000 ft. (0 to 3,048 m)

Transit: 0 to 35,000 ft. (0 to 10,670 m)

Power Saving Feature

Conforms to the Energy Star Program of the United States
Environmental Protection Agency





TCO 92 compliant: Certified by TCO (the Swedish Confederation of Professional Employees) to have met global safety standards and power-saving features

TCO 95 compliant (applies to ColorSync Display only if marked with TCO 95 on rear housing)





Apple ColorSync Displays

Apple's ColorSync Displays feature advanced color calibration for outstanding image quality and color consistency, both right out of the box and over time. Combining top-of-the-line Sony Trinitron CRT technology with innovative Apple software technologies and ergonomic design features, they're ideal viewing solutions for even the most demanding business and publishing professionals—and they offer an unparalleled return on investment.

Available in two sizes—17 and 20 inches (16.1- and 19-inch diagonal viewable image sizes)—the Apple ColorSync Displays give you precise, powerful control over virtually every viewing parameter. Taking advantage of Apple's unique hardware/software integration, these "intelligent" products replace the frequently difficult-to-reach (and always imprecise) mechanical dials used by most other displays with intuitive on-screen controls that take the guesswork out of making even the most minute adjustment. The ColorSync Displays also exhibit Apple's user-centered approach through an ergonomic design that features a tilt-and-swivel base (as well as state-of-the-art antireflective screen coating) for optimal viewing comfort.

Unparalleled color accuracy, impressive image quality, and outstanding ease of use are important, but the greatest value these advanced displays provide is their ability to streamline workflow and increase productivity. They do this through two key Apple technologies: ColorSync system-level software enables extraordinarily accurate screen-to-print color matching—so accurate that you can actually proof color on-screen and then move straight to print. Apple DigitalColor technology saves you time and money by ensuring accurate color calibration over time, as well as allowing adjustments to compensate for the effects of ambient lighting and CRT phosphor aging.

Simply put, with their combination of consistent color accuracy and affordability, Apple ColorSync Displays can improve not only the way you view your work, but also the way you *do* your work—as well as what you see when you look at the bottom line.



Features

Advanced color calibration

- Incorporates advanced Apple DigitalColor technologies:
 - Internal calibration technology to keep colors accurate and consistent over time
 - Adjustment for white-point accuracy to accommodate varying viewing environments
- Uses Apple's ColorSync technology to provide extremely accurate on-screen color representation and color matching across a range of devices

Outstanding image quality and flexibility

- Features Sony Trinitron CRT technology for clear, sharp pictures and vivid color
- Features multiple-scan electronics that enable a high level of viewing flexibility
- Takes advantage of Apple's unique hardware/software integration to provide intuitive, software-based control over all screen geometry

Ergonomic design

- Reduces eyestrain through its antireflective screen coating
- Offers a tilt-and-swivel base for maximum viewing comfort and ease of use
- Makes connecting a keyboard and mouse easy through its integrated Apple Desktop Bus (ADB) ports
- Complies with the strict TCO 95 environmental standards

Compatibility

- Supports easy connection to both Mac OS- and Windows-based computers



Apple ColorSync Displays

Technical Specifications

Picture tube

- 17- or 20-inch (diagonal) Sony Trinitron CRT (16.1- or 19-inch diagonal viewable image size)
- 0.26-mm aperture grille pitch

Resolutions and screen refresh rates*

- 640 by 480 pixels at up to 75 Hz
- 800 by 600 pixels at up to 75 Hz
- 832 by 624 pixels at up to 75 Hz
- 1,024 by 768 pixels at up to 75 Hz
- 1,152 by 870 pixels at up to 75 Hz
- 1,280 by 1,024 pixels at up to 75 Hz
- 1,600 by 1,200 pixels at up to 75 Hz (20-inch model only)

Scanning rates

- 17-inch model: 30 kHz to 80 kHz (horizontal); 40 Hz to 120 Hz (vertical)
- 20-inch model: 30 kHz to 94 kHz (horizontal); 48 Hz to 120 Hz (vertical)

User controls (hardware and software)

- Power on/off
- Brightness
- Contrast
- Horizontal size and centering
- Vertical size and centering
- Convergence
- Rotation
- Pincushion
- Keystone
- Parallelogram
- Gamma curve
- Completely variable white-point selection: 4,100K to 9,300K

Screen treatment

- Antistatic, antireflective coating

Connectors

- 15-pin DSub connector for Macintosh systems
- 15-pin DSub VGA mini-adapter for PCs

Electrical requirements

- Line voltage: 90 to 264 V AC
- Frequency: 47 to 63 Hz, single phase
- Power: 125W (maximum) when operating; less than 60W in standby mode; less than 5W when computer is in energy-saver mode

Agency approvals

- MPR 2
- CE Mark
- EPA Energy Star compliant
- IEC 950
- UL1950
- CSA 950
- EN60950
- NUTEK
- TCO 95
- 17-inch model: CISPR 22 Class B (EN5008211)—complies with European EMC directive; VCCI Class 2
- 20-inch model: FCC Part 15 Class A; DOC Class 1

Environmental requirements

- Temperature: 50° to 104° F (10° to 40° C)
- Humidity: 10% to 80%, noncondensing
- Altitude: 0 to 10,000 feet (0 to 3,048 m)

System requirements

- Works with Macintosh and other Mac OS-based systems with 68040 or later processors running Mac OS 7.5 or later*
- Works with Windows 95- and Windows NT-based systems

Size and weight

17-inch model:

- Height: 16.8 inches (42.7 cm)
- Width: 16.2 inches (41.1 cm)
- Depth: 17.6 inches (44.7 cm)
- Weight: 49.0 lb. (23.0 kg)

20-inch model:

- Height: 18.7 inches (47.5 cm)
- Width: 19.1 inches (48.5 cm)
- Depth: 20.2 inches (51.5 cm)
- Weight: 67.4 lb. (30.6 kg)

**Not all models and configurations are capable of driving the monitor to the highest resolution it supports.*

Ordering Information

Apple ColorSync Displays

Order No. M6159LL/A
17-inch (16.1-inch diagonal viewable image size)

Order No. M6162LL/A
20-inch (19-inch diagonal viewable image size)

All Apple ColorSync Displays include the following:

- Apple Display software
- PC video adapter
- Integrated, attached video and ADB cable
- Power jumper cable
- Ambient light wand
- User's manual
- Limited warranty

For more information

For more information about these products, or to find out where to buy Apple products—through a reseller or from the Apple Store—visit www.apple.com or call 1-800-538-9696.





Troubleshooting

17" ColorSync Displays
(AppleVision 750, 750AV)





General

The Symptom Charts included in this chapter will help you diagnose specific symptoms related to your product. Because cures are listed on the charts in the order of most likely solution, try the first cure first. Verify whether or not the product continues to exhibit the symptom. If the symptom persists, try the next cure. (Note: If you have replaced a module, reinstall the original module before you proceed to the next cure.)

For additional assistance, contact Apple Technical Support.





First Checklist

Important: Many AppleVision 750 and 750AV display modules returned for repair are found to be fully operational. Read this checklist before you return a module, and prevent needless module replacement and unnecessary time delays.

 **The AppleVision 750/750AV Display is not compatible with all computers.**

This display works with both Macintosh and IBM PC-compatible computers. A video card may need to be installed to use this display with some computers. For more information, see the computer manual.

The display works with any computer that has the following timing ranges:

- Horizontal scan rate of 30-80 kHz
- Vertical refresh rate of 40-120 Hz

For best display performance, operate the display in one of the factory-preset screen resolutions listed in the Specifications chapter in this manual.

 **The CRT raster will not always resemble a perfect rectangle.**

CRT tolerances allow for some distortion. Additional distortion can be caused by magnetized metal objects (desks, file cabinets, etc.). Move the unit to a different location if you notice raster bowing or bent raster edges.

 **Jitter, faint lines, or screen movement can be caused by external interference such as electronic devices and fluorescent lights.**

Fluorescent lights, other monitors, or electronic appliances such as coffee makers and copy machines can cause raster distortion. Move the unit to another room or building to help determine if external interference is the source of the problem.

Note: If the raster has shifted up/down or right/left only, adjust it using the user controls. However, keep in mind that if you then move the monitor you may need to readjust the centering controls.

If the display changes (for better or worse) when you move it to another location, the environment is the source of the problem. Relocate the monitor or move the distortion-causing object.





 **A maladjusted screen can mimic the symptoms of main deflection board or CRT failures.**

By performing the adjustment procedures, you might determine if one or more of the adjustments is the cause of the problem.

 **Variations in screen color and brightness are usually caused by the setup controls or the environment.**

Screen color purity over the entire screen is never perfect. CRT tolerances allow for some distortion.

Try adjusting the rotation, brightness, or contrast to reduce or eliminate the symptom.

Color imperfections can be caused by magnetized metal objects (desks, file cabinets, etc.). Move the unit to a different location if you notice color blotches or a change in brightness on an area of the screen. If the display changes (for better or worse) when you move it to another location, the environment is the source of the problem. Relocate the monitor or move the distortion-causing object.





Symptom Charts

Important: For procedures that require the monitor to be turned on, allow the monitor to warm up for approximately 20 minutes, unless instructed otherwise.

Important: Ensure the latest version of Apple Display software (1.5.3 or later) is installed. (Apple Display software supersedes and replaces AppleVision software as of version 1.5.3.)

Caution: For procedures that require a second known-good monitor, do not use an AppleVision or ColorSync display. Connecting a second AppleVision or ColorSync monitor could cause the AppleVision software to operate erratically.

No Raster

No raster (screen is black); power indicator light on

- 1 Verify computer signal by connecting a known-good monitor. Then disconnect the known-good monitor and reconnect the ColorSync display. Ensure the monitor's video cable and ADB cable are connected to the computer.
- 2 Adjust front panel brightness and contrast controls (they may be set too low).
- 3 Check for presence of high voltage (see "Checking High Voltage" in this chapter). High voltage is present if you hear a rustling sound when the display is turned on or off. If high voltage is present, confirm Apple Display software 1.5.3 or later is installed. To operate the built-in recovery function, start up the computer and hold down the keys command-option-a-v until you hear a system alert or the screen image is restored. Apple Display software will detect a "no video" condition at startup and will correct the condition when the extension loads.
- 4 Replace main deflection board. Then adjust the display (see "Adjusting the Display after Replacing the Main Deflection Board" in this chapter).
- 5 Replace CRT/video board only if the service strategy in your region supports CRT/video board replacement.
- 6 US only: Call Apple Technical Support at 1-800-919-2775.





No raster (screen is black); power indicator light off

- 1 Verify that monitor is connected to live power source, that power button is on, and that computer is turned on.
Important: Be sure the ADB and video cables from the monitor are connected to the ports on the computer.
- 2 Check that all internal cables are connected and that CRT/video board is properly seated on CRT socket.
- 3 Replace main deflection board. Then adjust the display (see “Adjusting the Display after Replacing the Main Deflection Board” in this chapter).
- 4 Replace CRT/video board only if the service strategy in your region supports CRT/video board replacement.
- 5 US only: Call Apple Technical Support at 1-800-919-2775.

No raster (screen is black) after Restart

- 1 Turn off the monitor's power button, and then turn it on again. (This is a quick fix; this symptom causes no permanent damage to the display.)
- 2 Replace main deflection board. Then adjust the display (see “Adjusting the Display after Replacing the Main Deflection Board” in this chapter).
- 3 US only: Call Apple Technical Support at 1-800-919-2775.

Geometry

Shape of raster is distorted

- 1 Use Monitors & Sound control panel to adjust the display for optimum screen performance. If necessary, click Factory Settings button in Monitors & Sound control panel (refer to the Adjustments chapter).
- 2 Replace main deflection board. Then adjust the display (see “Adjusting the Display after Replacing the Main Deflection Board” in this chapter).
- 3 Replace CRT/video board only if the service strategy in your region supports CRT/video board replacement.
- 4 US only: Call Apple Technical Support at 1-800-919-2775.

Raster is distorted only in some resolutions

- 1 Check for supported resolutions in the Specifications chapter.
- 2 Reboot computer and click Factory Settings button in Monitors & Sound control panel (see Adjustments chapter).
- 3 Replace main deflection board. Then adjust the display (see “Adjusting the Display after Replacing the Main Deflection Board” in this chapter).
- 4 Replace CRT/video board only if the service strategy in your region supports CRT/video board replacement.
- 5 US only: Call Apple Technical Support at 1-800-919-2775.





Screen Color

Screen is one predominant color

- 1 Verify that CRT/video board is properly seated on CRT socket.
- 2 Using Monitors & Sound control panel, click Recalibrate button (see the Adjustments chapter).
- 3 With Apple Display software (version 1.5.3 or later) installed, start up the computer and hold down the keys command-option-a-v until you hear a system alert or the screen image is restored.
- 4 Replace CRT/video board only if the service strategy in your region supports CRT/video board replacement.
- 5 US only: Call Apple Technical Support at 1-800-919-2775.

Screen has color rainbow effect (bands of color across the screen)

- 1 Use a manual degaussing coil to degauss the screen. (You can purchase a degaussing coil for about \$25 at most larger electronic parts stores.)
- 2 Replace main deflection board. Then adjust the display (see “Adjusting the Display after Replacing the Main Deflection Board” in this chapter).
- 3 Replace CRT/video board only if the service strategy in your region supports CRT/video board replacement.
- 4 US only: Call Apple Technical Support at 1-800-919-2775.

Screen Brightness

Screen is very bright (monitor might shut down)

- 1 If possible, from the Monitors & Sound control panel, click Recalibrate button.
- 2 With Apple Display software (version 1.5.3 or later) installed, start up the computer and hold down the keys command-option-a-v until you hear a system alert or the screen image is restored.
- 3 Replace main deflection board. Then adjust the display (see “Adjusting the Display after Replacing the Main Deflection Board” in this chapter).
- 4 Replace CRT/video board only if the service strategy in your region supports CRT/video board replacement.
- 5 US only: Call Apple Technical Support at 1-800-919-2775.





Focus

Focus poor

- 1 Using the Monitors & Sound control panel, verify that convergence is set correctly. Maladjusted convergence gives the appearance of bad focus.
Note: Convergence over entire screen is never perfect.
- 2 Using the Display Service Utility (inside the Diagnostics Utilities folder on the Service Source Companion CD), select focus pattern. For best screen focus, use a plastic adjustment tool to adjust H focus and V focus controls that are mounted on the flyback transformer.
- 3 If focus is still poor, one of the CRT socket wires may be improperly secured. Refer to the Take Apart chapter to secure the red and white wires correctly in the CRT socket.
- 4 Readjust the focus controls. If adjusting focus controls has no effect, replace main deflection board. If necessary, repeat step 2 and step 3.
- 5 Replace CRT/video board only if the service strategy in your region supports CRT/video board replacement.
- 6 US only: Call Apple Technical Support at 1-800-919-2775.

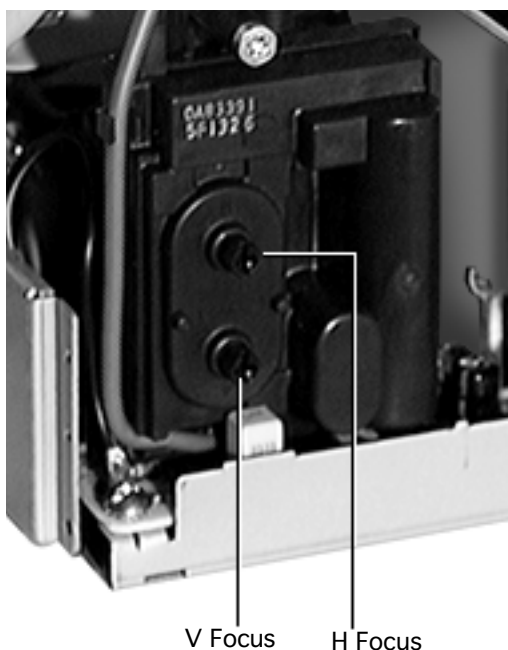

Center of screen remains blurry after adjusting focus and convergence

- 1 Use a standard plastic hex tool to adjust H-Stat (lower left side of CRT/video board).
- 2 If center-of-screen appearance is good, but top/bottom convergence is blurry, use a plastic adjustment tool to adjust the top and bottom convergence (back of CRT/video board).
- 3 If screen is still blurry after adjusting convergence, one of the CRT socket wires may be improperly secured. Refer to "CRT/Video Board" in the Take Apart chapter to secure the red and white wires correctly in the CRT socket.

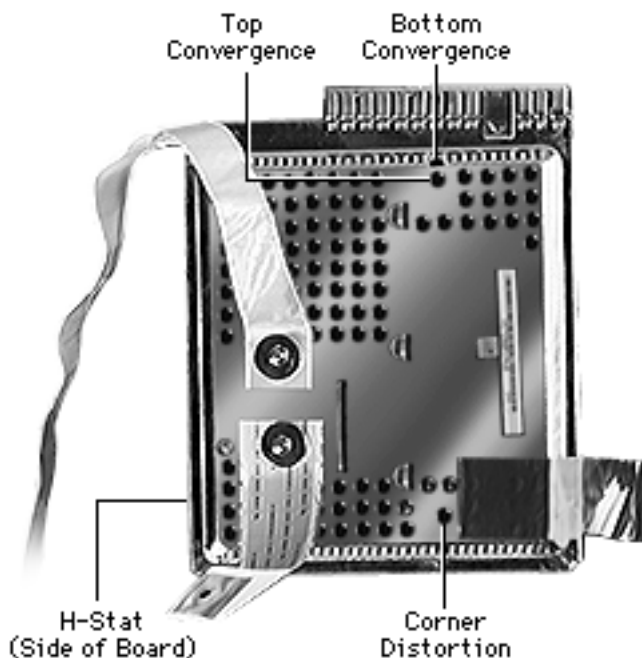



Audio (750AV only)

The symptoms associated with a defective sound enclosure are relatively easy to diagnose. Following are typical symptoms of a defective audio system. However, some of these symptoms can also be caused by defective speakers, the built-in microphone, and connectors or cables that plug into the sound enclosure.

- No sound left/right channel
- No recording capability (internal/external microphone)
- No volume/bass/treble control
- Sound distortion
- No gain control (line in and external microphone)
- Loud popping sounds
- Headphones have no sound

Miscellaneous

Microphone doesn't work

- 1 Without removing rear housing, disconnect microphone from bezel of AppleVision 750AV Display.
- 2 Connect microphone to known-good AppleVision 750AV Display to verify whether it works.
 - If microphone doesn't work, replace it. Because microphone cable might also be damaged, go to the next step to check it.
 - If microphone works, check microphone cable (as described in the next step).
- 3 With microphone disconnected, use a DC voltmeter to check contacts on microphone connector that is secured inside monitor bezel. The voltmeter should measure 8 volts DC.
- 4 If voltmeter reads 0 VDC, remove sound enclosure, connect extension cables to head unit, and measure voltage at the microphone connector (BA10) on sound board.
 - If voltmeter measures 8 volts DC, replace microphone cable
 - If voltmeter measures 0 VDC on sound board at BA10, replace sound board

Suspected hardware problem because checking cables, power, software, and other front-of-screen cures did not solve problem

Refer to "Diagnosing a Suspected Hardware Problem" in this chapter.





Downloading Setup Parameters and Replacing the CRT/Video Board*

* **Important:** Some countries do not support replacement of the CRT/video board. Check the service strategy in your region before continuing this procedure.

The following steps show the procedure for

- Creating (downloading) a parameter settings file
- Duplicating the parameter settings file
- Replacing the CRT/video board
- Writing (uploading) the display parameters

Important: When you connect the monitor to a computer, be sure to connect the ADB cable from the monitor's video cable to the ADB port on the computer.

Download Parameter Settings

- 1 With the power off, install the jumper (from kit part number 076-0529) in connector BV1 (next to the BV2 ribbon cable) on the right side of the CRT/video board.
- 2 Turn on the computer and the monitor.
- 3 Copy the application called Display Service Utility (inside the Diagnostics Utilities folder on the Service Source Companion CD) to the desktop.
- 4 Open the copy of the DSU and select AppleVision 750/750AV pattern selections.
- 5 To download parameters from the CRT/video board, click Create File. A message appears explaining that the process will take about 3 minutes.
- 6 When the message disappears, a new file called Parameter Settings 750 is created on the same level as the Display Service Utility application.

Caution: To avoid loss of data, do not move or rename the Parameter Settings file.

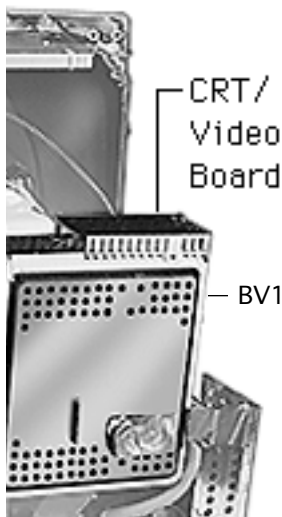



Duplicate the Parameter Settings File

- 1 Locate the Parameter Settings 750 file, but do not move or rename it.
- 2 Beside the Parameter Settings 750 file create a new folder.
- 3 Name the new folder Parameter File Backup.
- 4 Hold down the option key and drag the Parameter Settings 750 file onto the Parameter File Backup folder.
- 5 Shut down the monitor. Unplug the power cord.

Replace the CRT/Video Board

- 1 Remove the defective CRT/video board and replace it with a new CRT/video board. Refer to “CRT/Video Board” in the Take Apart chapter.
- 2 Remove the jumper from the defective CRT/video board, and install it on the new CRT/video board.
- 3 Reattach the power cord. Restart the computer.
- 4 Open the Display Service Utility and select AppleVision 750/750AV pattern selections.

Upload Parameter Settings

- 1 To upload parameter settings, use the Display Service Utility and click Write File. A message appears explaining that the process will take about 3 minutes. In this time the screen will blink 2 to 3 times before the Parameter Settings 750 file is uploaded.
Note: If the Write File button is grayed out, this means the application can't find the Parameter Settings 750 file. Make sure you did not move or rename the original file.
- 2 When the message disappears, quit the Display Service Utility.
- 3 Turn off the monitor and remove the jumper.
- 4 After about 5 seconds, turn on the monitor.
- 5 Drag the AppleVision Preferences folder into the trash. Restart the computer.
- 6 Open the Monitors & Sound control panel, and click the Geometry button.
- 7 Hold down the option key and click Factory Settings.
- 8 Go to the next procedure: “Adjusting the Display after Replacing the CRT/Video Board.”





Adjusting the Display after Replacing the CRT/Video Board*

* **Important:** Some countries do not support replacement of the CRT/video board. Check the service strategy in your region before continuing this procedure.

Caution: Perform this procedure only after you've replaced the CRT/video board and uploaded the parameter settings.

After replacing the CRT/video board, some adjustment is necessary. The following steps show the procedure for

- Adjusting screen geometry
- Adjusting screen convergence
- Recalibrating white points

Adjust Geometry

If the screen is displaying keystoneing, open the Display Service Utility, select AppleVision 750/750AV pattern, and click the Adjust Geometry button. Using the keystone slider control, you can adjust the width of the top and bottom of the screen. If necessary, use the Display Service Utility to make other geometry adjustments. Click the Save button to store the adjustments in user and factory mode. Trash the AppleVision Preferences folder, and Restart the system.

Adjust Convergence

- 1 Use Monitors & Sound to select Convergence and set the convergence for the best center-of-screen appearance. Refer to Convergence in the Adjustments chapter.
- 2 If center-of-screen appearance is still blurry, use a standard hex tool to adjust H-Stat (lower left side of CRT/video board).
- 3 If center-of-screen appearance is good, but the top/bottom convergence is blurry, use the plastic adjustment tool to adjust the top and bottom convergence (back of CRT/video board).
- 4 If the screen is still blurry after adjusting convergence, one of the CRT socket wires may be improperly secured. Refer to the Take Apart chapter to secure the red and white wires correctly in the socket.
- 5 If the screen is still blurry, check the high voltage. Refer to "Checking High Voltage" in this chapter.

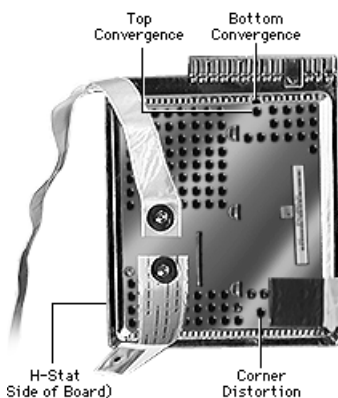



Recalibrate White Points

Caution: If the video cable is connected to a third-party video card that uses proprietary color calibration drivers, you might need to disable the drivers to use the AppleVision color calibration functions.

- 1 After you've rewritten the file, as instructed in "Upload Parameter Settings," restart the system.
- 2 Open Monitors & Sound and select Color.
- 3 Select the default 9300 white point and click Recalibrate.
 - If you later choose another white point such as 6500 or D50, you must click Recalibrate for the changes to take effect.
 - If the display looks blurry after recalibrating, adjust convergence as described in the previous section.
 - If you hold down the option key and click Factory Settings, it might be necessary to perform a minor convergence adjustment using Monitors & Sound.
- 4 If the Recalibration fails, a warning message will appear. Click OK and click Recalibrate again.
- 5 If the recalibration fails again, use the duplicated file to upload the parameter settings. (Hold down the option key and drag the Parameter Settings 750 file out of the Parameter File Backup folder; then follow the procedure under "Upload Parameter Settings.") Adjust the display. If the recalibration fails again, click Recalibrate.

Note: These multiple recalibration attempts might seem excessive, however lab tests have confirmed a high success rate at saving the display and preventing needless replacements.
- 6 If the recalibration fails again (after the fourth attempt), call Apple Technical Support. (In the US, call 1-800-919-2775, option 3.)





Adjusting the Display after Replacing the Main Deflection Board

After replacing the main deflection board, perform the following adjustments for all three Macintosh modes (screen resolutions):

- 640x480 at 67 Hz
- 832x624 at 75 Hz
- 1024x768 at 75 Hz

- 1 Using the control strip (or the Monitors control panel), select 1024x768, the highest of the three Macintosh screen resolutions.



- 2 Open the Display Service Utility (DSU) and select Pattern Selections: AppleVision 750/750AV.
- 3 Refer to the procedure called "Checking High Voltage" in this chapter to verify that the high voltage is 26 kV. If the high voltage is not 26 kV, adjust the high voltage using the DSU, the multimeter, and the high-voltage probe. Use the high voltage slider control on the DSU to make final adjustments.
- 4 Using the DSU, select the focus pattern (percent signs). Adjust horizontal and vertical focus controls for best center-of-screen performance. If necessary, readjust each focus control to optimize overall focus.

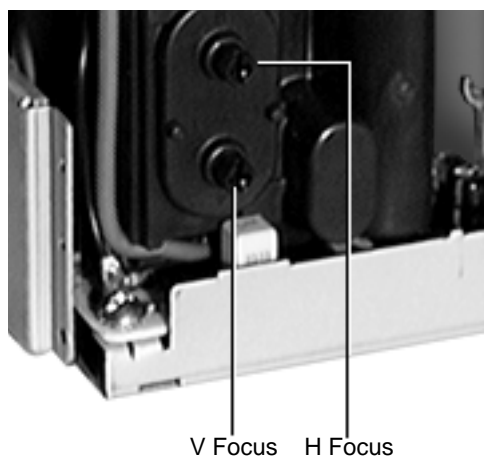



- 5 If necessary, repeat step 4 for the best overall focus.
- 6 Check the screen to see if any minor geometry adjustments are necessary. If so, shut down the monitor and unplug the power cord. Install the jumper on the CRT/video board. Reattach the power cord. Restart the computer. Open the Display Service Utility and select AppleVision 750/750AV pattern selections. Use the DSU geometry slider controls to adjust the display. Turn off the monitor before removing the jumper.
- 7 For the two remaining Macintosh modes, check the screen, and if necessary, repeat this procedure but leave out steps 3, 4, and 5.





Checking High Voltage

This high-voltage check is a required procedure for some of the symptoms in this chapter. After checking high voltage, return to the symptom chart, if necessary.

Caution: Do not attempt this procedure without the Apple high-voltage probe (Apple part number 076-0392). Use only the Apple high-voltage probe; other high-voltage probes will not give accurate readings for this procedure.

Warning: Read all of the warnings, notes, and steps of this procedure before beginning.

Warning: Voltage at the anode, with the power on, can cause serious injury. Double-check all multimeter connections before taking the reading. Probe the anode carefully. Serious damage and injury may occur if the anode is knocked off while the CRT is charged.

- 1 Turn off the monitor and computer. Disconnect the power cords and video/ADB cables. Wait at least two minutes for the CRT to discharge.
- 2 Refer to the Take Apart chapter to remove the following:
 - Microphone assembly/blank plate
 - Sound enclosure
 - Rear housing
- 3 Attach the Apple high-voltage probe to a multimeter and attach the ground wire to the chassis.

Warning: Verify that the ground wire connection to the chassis is secure.
- 4 From the rear of the CRT—away from the CRT frame—carefully insert the probe under the anode cap.
- 5 With the power switches off, connect the power cords and video/ADB cables.
- 6 Turn on the computer and monitor.
- 7 The reading should be 26 VDC on the meter. This is actually 26 kV. Most of the voltage is across the high-voltage probe.

Warning: Do not remove the probe from under the anode cap until power is turned off. Injury or damage to equipment may occur.
- 8 If reading is 0 VDC, replace the main deflection board.
- 9 Turn off the monitor.
- 10 Unplug the monitor.
- 11 Remove the probe from under the anode cap.
- 12 Go back to the symptom chart for the next cure, if necessary.





Diagnosing A Suspected Hardware Problem

After ruling out other possible cures (that is, you have already checked cable connections, power, AppleVision software, and other possible front-of-screen cures), use the following procedure to help determine and resolve hardware problems. (See the flowchart at the end of this chapter for a simplified depiction of this process.)

- 1 If the problem is a completely black screen, connect another known-good display (not an AppleVision or ColorSync display) as follows. Use a computer that has a video card so you can connect both displays to the computer. Connect the known-good display to the built-in monitor port; connect the 750(AV) display to the video card connector.
- 2 If the problem involves a partially visible screen (you can see the screen desktop and read the screen icons), there is no need to connect a second display.
- 3 Turn on the computer and the monitor(s). If using a second display, confirm that the known-good display is set up as the main startup screen (Monitors & Sound control panel).
- 4 Open the application called Display Service Utility (from the Diagnostics Utilities folder on the Service Source Companion CD).
- 5 Select AppleVision 750/750AV pattern selections.
- 6 Click Create File. A message appears explaining that the process will take about 3 minutes.





- 7 If a dialog box appears that says the Display Service Utility (DSU) is unable to communicate with the display, then remove the monitor housing, and use a multimeter to measure the voltage between chassis ground and resistor RL1 on the end closest to capacitor CP17 on the main deflection board:

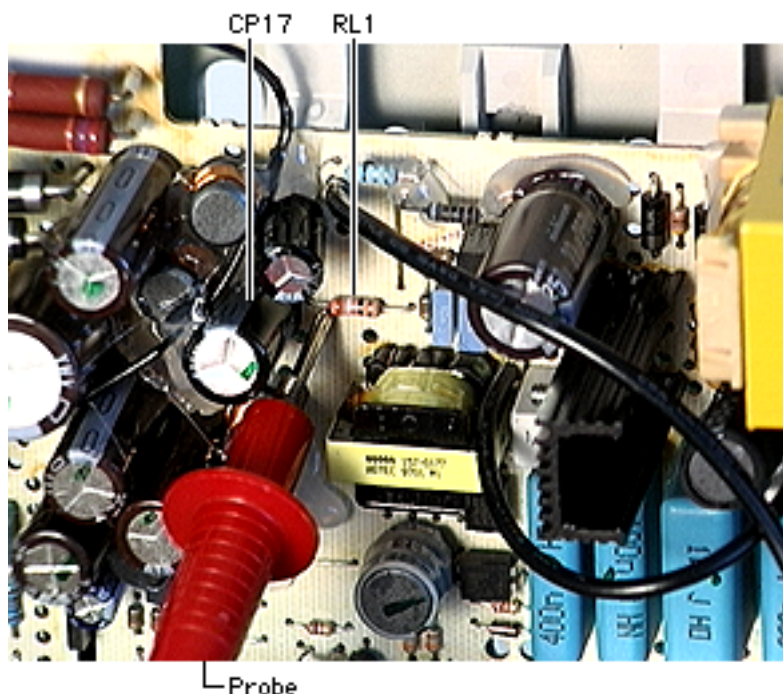

- If the voltage measures 11.5 V to 12.5 V, replace the CRT/video board
 - If the problem is gone, adjust the display as described in “Adjusting the Display after Replacing the CRT/Video Board” in this chapter.
 - If the problem persists, reassemble the monitor, and return the display for whole unit or head unit replacement (following the service strategy in your region).
- If the voltage measures less than 11.5 V or greater than 12.5 V, replace the main deflection board (refer to the Take Apart chapter). Reconnect the display to the computer and turn on the computer and monitor.
 - If the problem is gone, adjust the display as described in “Adjusting the Display after Replacing the Main Deflection Board” in this chapter.
 - If the problem persists, reassemble the monitor, and return the display for whole unit or head unit replacement (following the service strategy in your region).





- 8 If the Create File process finishes successfully, click Adjust Geometry. Clicking this button causes the DSU to automatically verify EHT (high voltage). Use a probe to measure the high voltage. (Refer to “Checking High Voltage” in this chapter.)
 - If the high voltage is okay, replace the CRT/video board and adjust the display (see “Adjusting the Display after Replacing the CRT/Video Board” in this chapter). If the hardware problem still exists after completing the adjustments, return the display for whole unit or head unit replacement (following the service strategy in your region).
 - If there is no high voltage, replace the main deflection board and adjust the display (see “Adjusting the Display after Replacing the Main Deflection Board” in this chapter). If the hardware problem still exists after completing the adjustments, return the display for whole unit or head unit replacement (following the service strategy in your region).



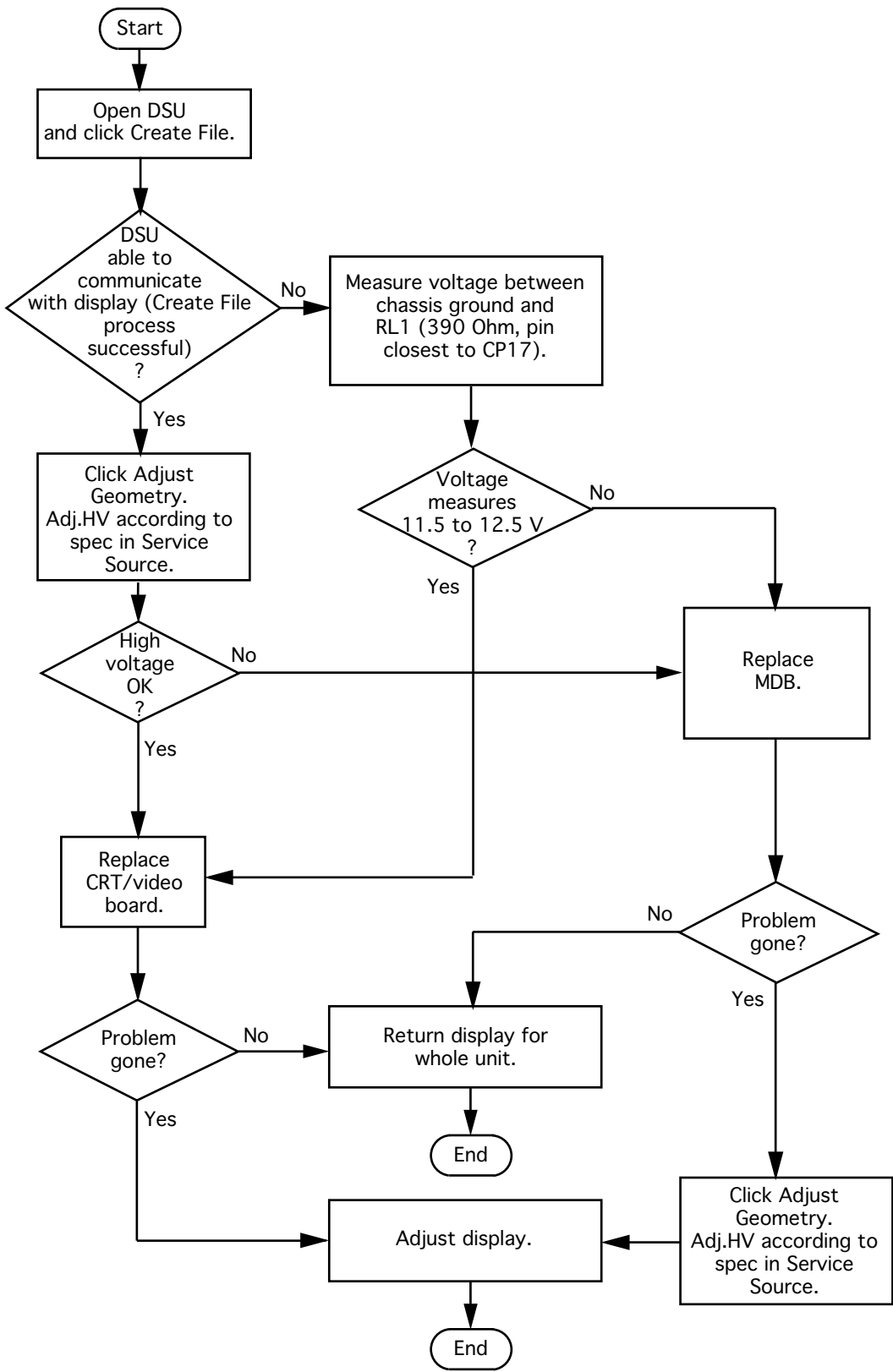



Take Apart

17" ColorSync Displays
(AppleVision 750, 750AV)





Model Differences

Unless indicated otherwise, the procedures in this chapter apply to both models. Procedures and steps that only apply to one of the models are indicated with the model number (750 or 750AV).

Important: Effective January 1998, TCO 95 plastics are used for the 17" ColorSync Display (not the AV version) and are identified by the TCO 95 marking on the back of the rear housing. Replace the following TCO 95 housing parts like-for-like:

- 076-0723 ADB Board Panel, TCO 95
- 922-3335 Front Bezel, TCO 95
- 922-3338 Rear Housing, TCO 95
- 922-3343 Bottom Housing, TCO 95
- 922-3387 Blank Plate, TCO 95





Microphone Assembly/Blank Plate

No preliminary steps are required before you begin this procedure.

Note: The microphone assembly is on the 750AV display; the blank plate is on the 750 display. To protect the microphone assembly or blank plate, remove it before removing the sound enclosure or rear housing.



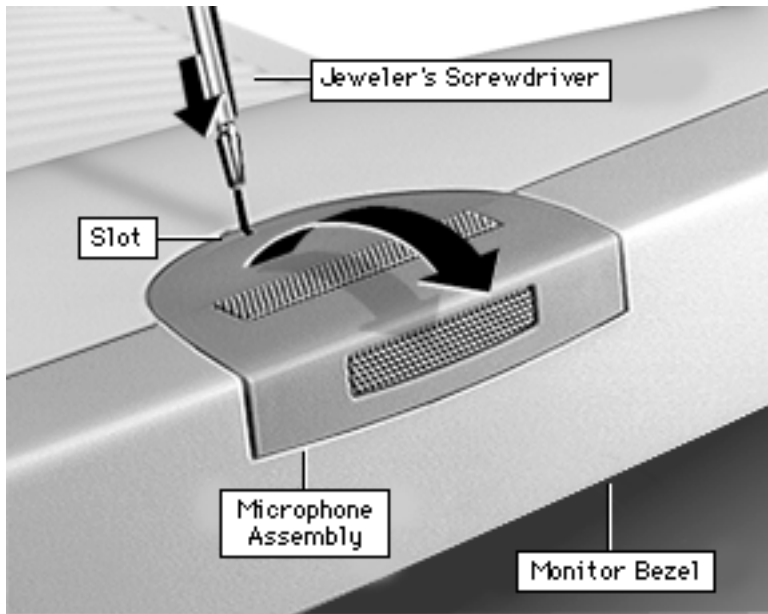

- 1 Place a jeweler's screwdriver in the microphone assembly slot. Press the screwdriver down and toward the bezel to release a tab that holds the microphone to the bezel and rear housing.
- 2 Grasp the microphone assembly with your other hand, and tilt it up and away from the monitor bezel.



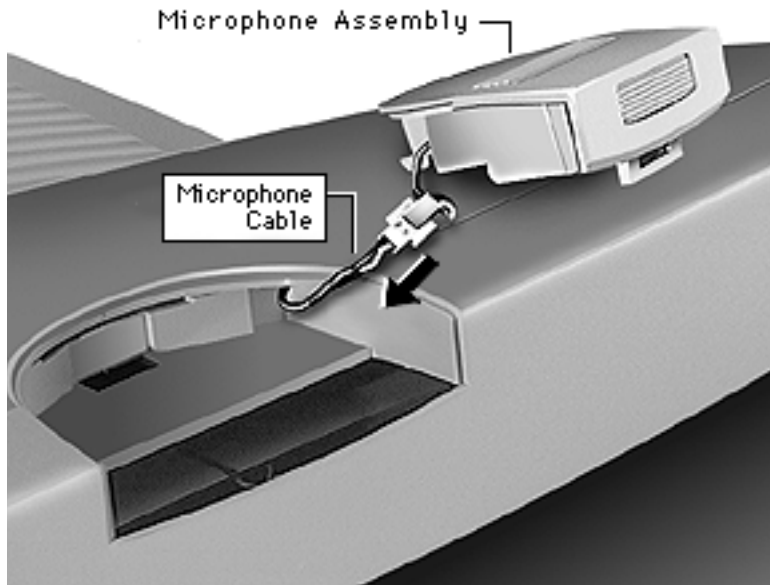

- 3 Disconnect the microphone cable and remove the microphone assembly.





Sound Enclosure (750AV only)

Before you begin, remove
the microphone assembly.



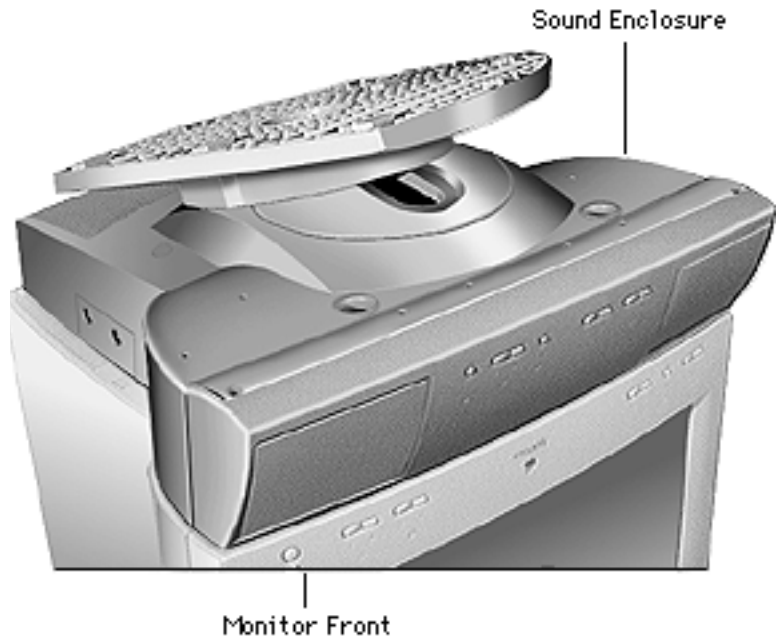

- 1 Place the monitor upside down on a protective pad.





- 2 Peel off the two adhesive disk screw covers. Stick them beside the screw holes.

Replacement Note:
After reinstalling the sound enclosure, replace the adhesive disk screw covers. They help maintain the sound integrity of the speaker chamber.



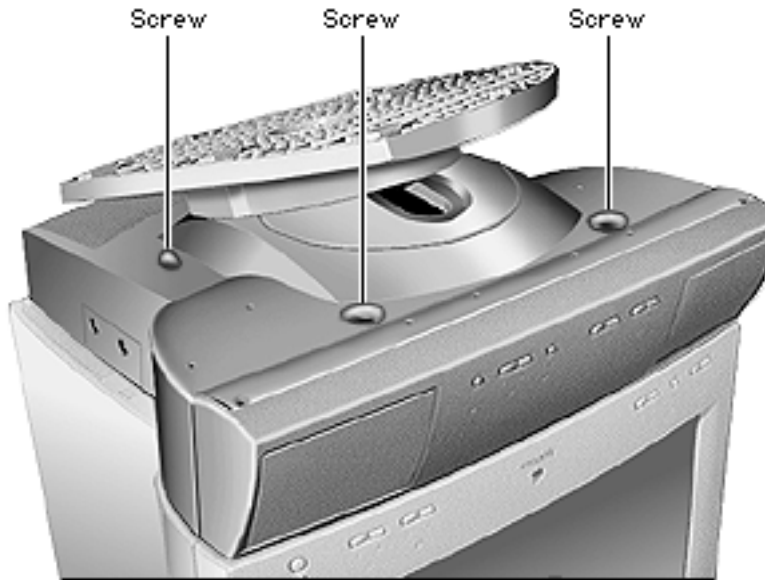

- 3 Use a long T-15 torx driver to loosen (but not remove) the four corner screws.

Important: Do not remove the captive screws; they are held in place by rubber grommets inside the sound enclosure.



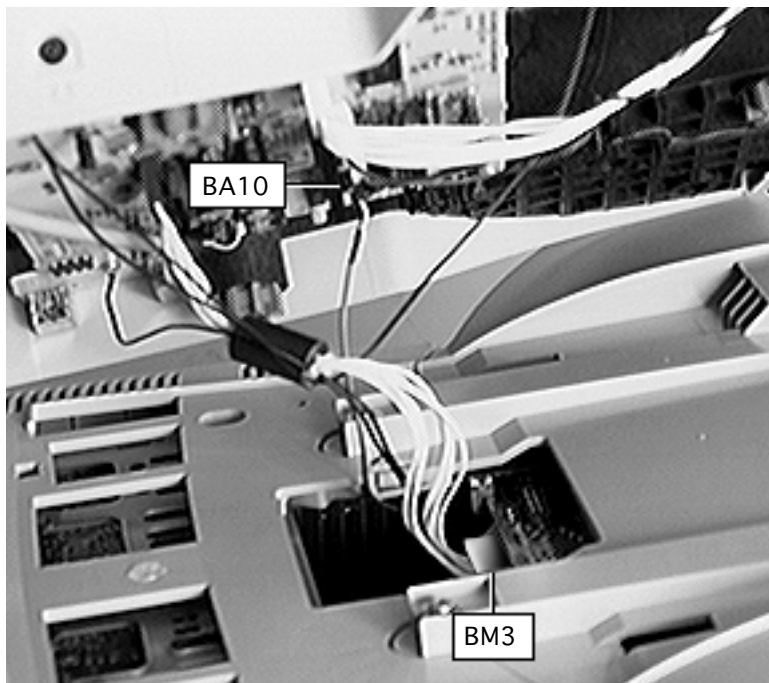

- 4 Tilt up the sound enclosure, away from the monitor side.
- 5 While holding the sound enclosure up, disconnect
 - Connector at BM3 on the sound board (white wires)
 - 2-pin connector at BA10 on the sound board (gray wire)



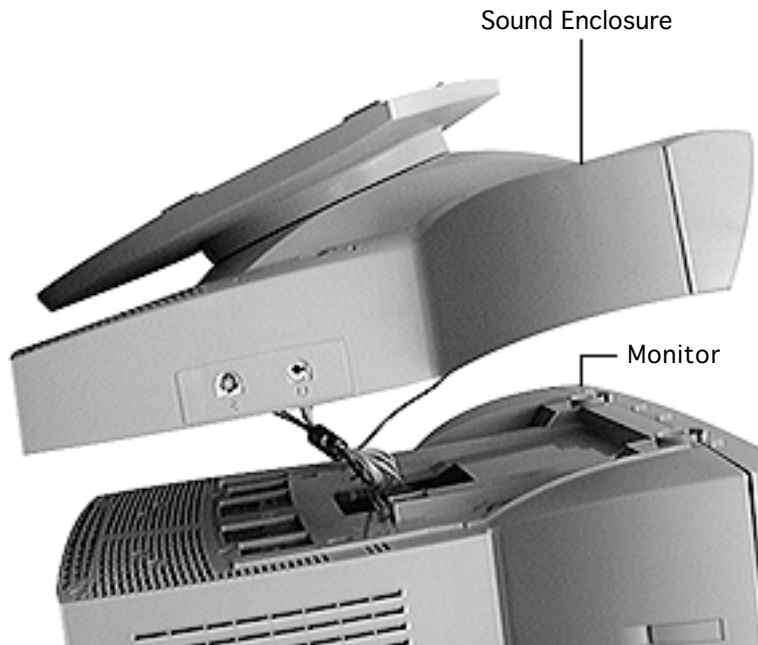

- 6 Lift the sound enclosure straight up and away from the monitor.



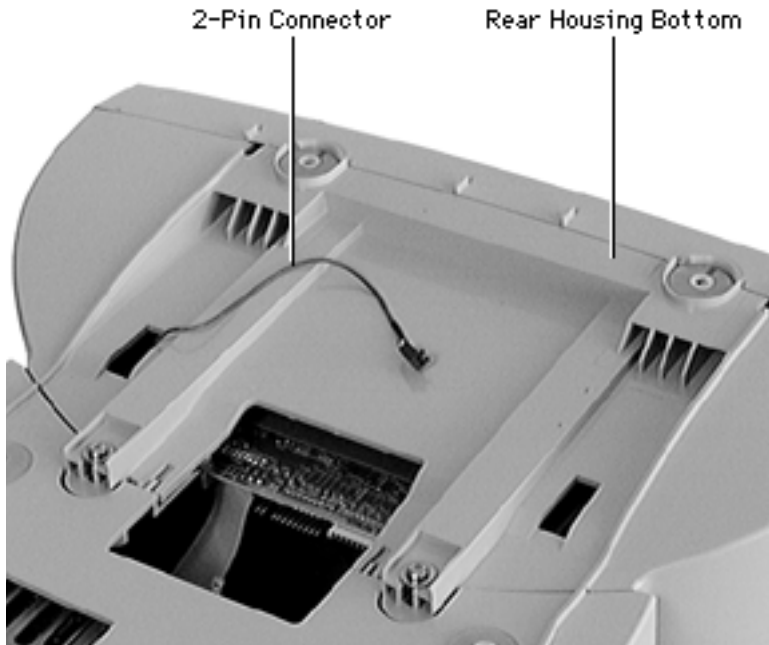

Replacement Note: Ensure that the 2-pin connector wire is routed through the rectangular opening in the rear housing before securing it to the sound board at BA10.





Sound Enclosure Bezel (750AV only)

Before you begin, remove the following:

- Microphone assembly
- Sound enclosure



Sound Enclosure Bezel



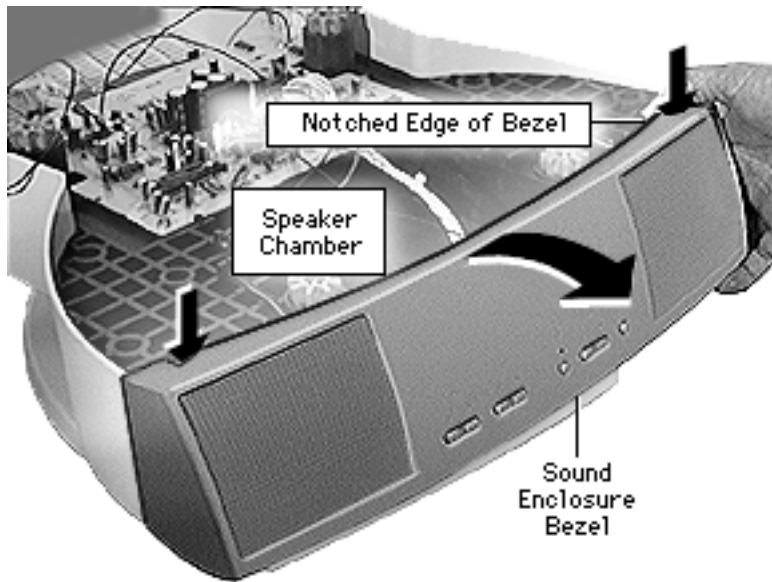

- 1 If you see glue where the bezel and the speaker chamber meet, cut through the glue with a sharp knife.
- 2 With the bezel facing you, place your thumbs on the notched top edges and pull the bezel up and toward you to release the tabs.



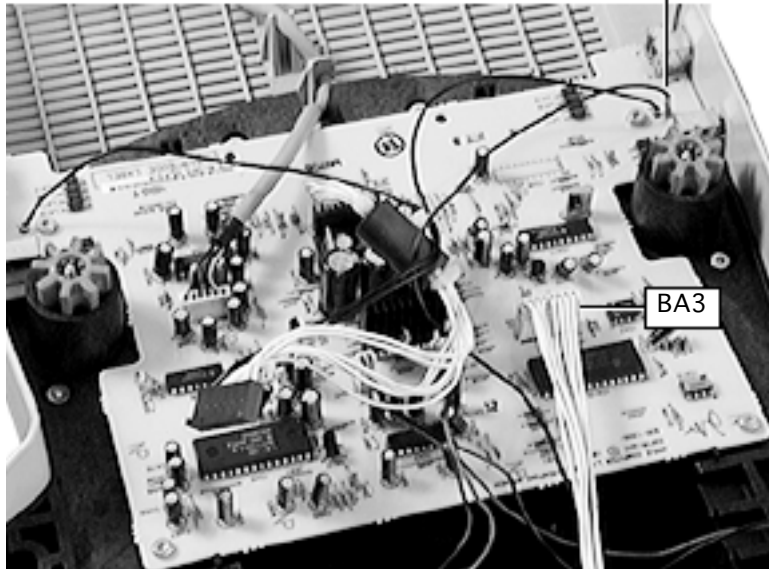

- 3 Disconnect the cable at BA3 from the sound board.
- 4 Disconnect the single-pin connector at HA3 from the sound board.





- 5 Remove the three T-8 torx screws from the sound control board.

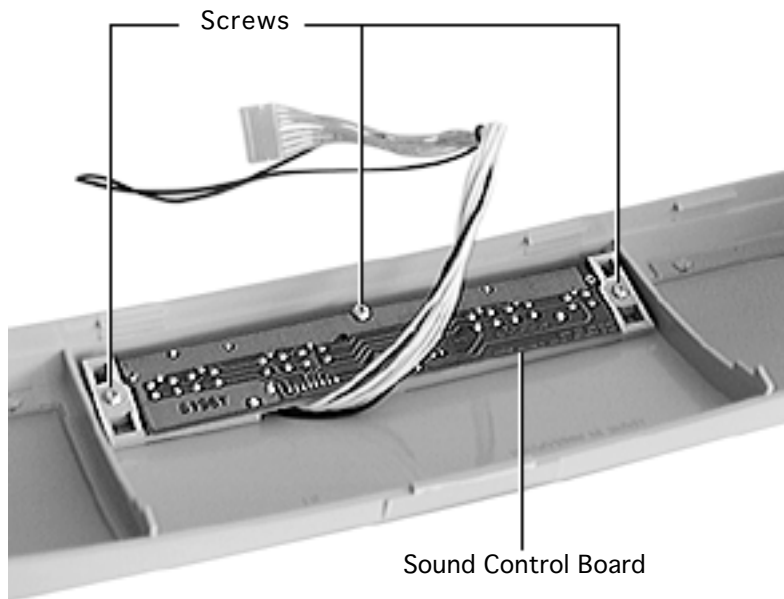



Speakers (750AV only)

Before you begin, remove the following:

- Microphone assembly
- Sound enclosure
- Sound enclosure bezel

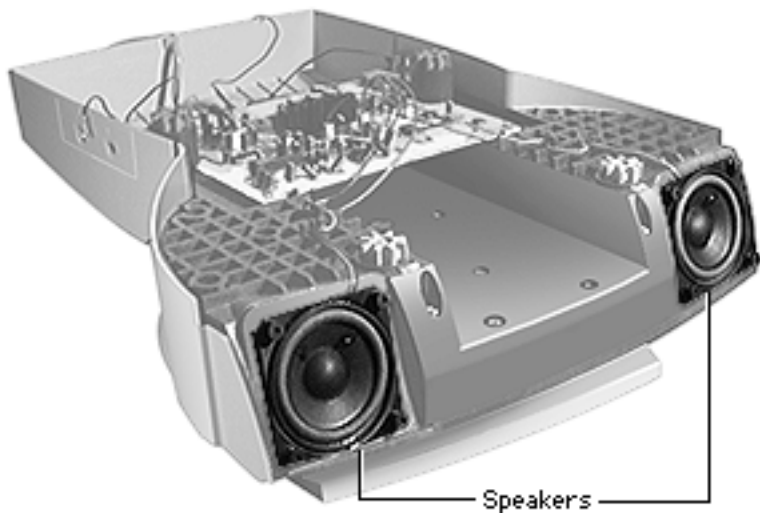

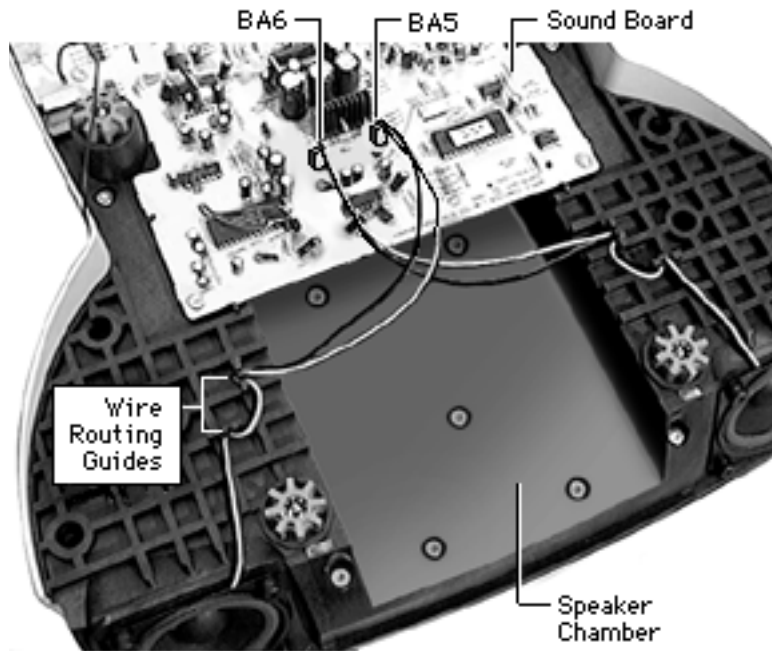

- 1 Disconnect speaker wires BA5 and BA6 from the sound board.

Replacement Note: The speaker wires must cross each other. So when the front of the sound enclosure is facing you, the left speaker wire connects to the right connector at BA5, and the right speaker wire connects to the left connector at BA6. When replacing a speaker, route the wires through the guides on the speaker chamber.



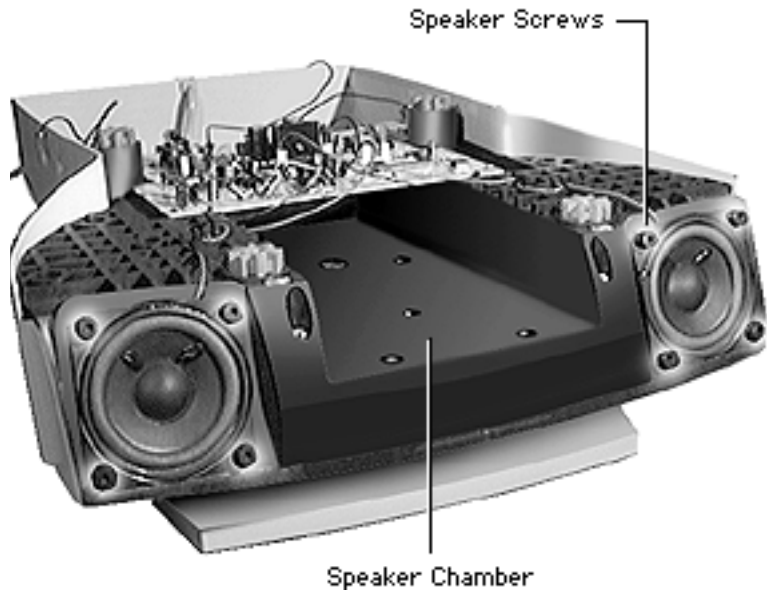

- 2 Remove the four T-15 torx speaker screws.

Caution: When replacing a speaker, do not overtighten the screws.



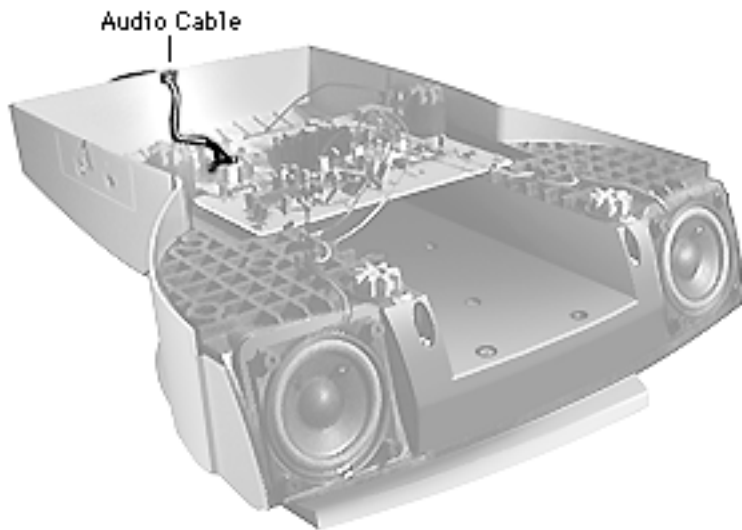

Audio Cable (750AV only)

Before you begin, remove the following:

- Microphone assembly
- Sound enclosure



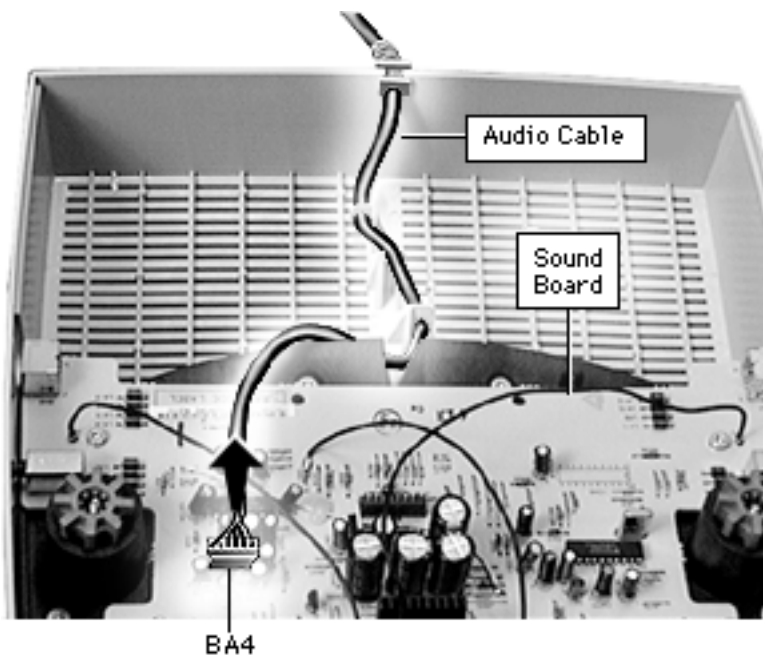

- 1 Disconnect the audio cable from connector BA4 on the sound board.
- 2 Lift the cable from the plastic guides and from the slot in the sound enclosure.



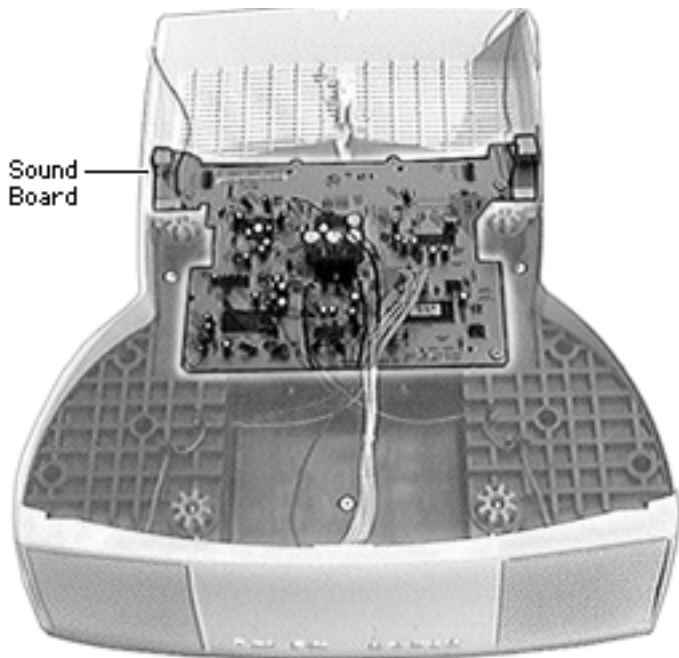

Sound Board (750AV only)

Before you begin, remove the following:

- Microphone assembly
- Sound enclosure
- Audio cable



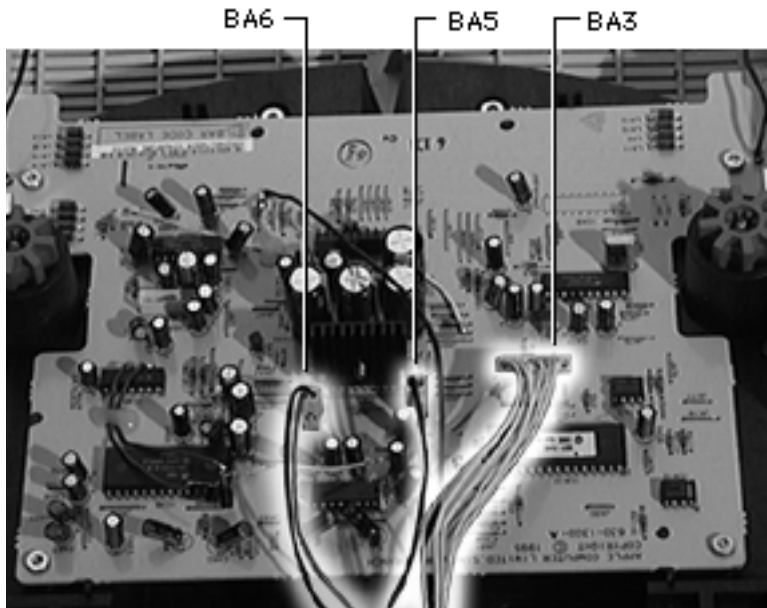

- 1 Disconnect from the sound board
 - Connector at BA3
 - 2-pin connector at BA5
 - 2-pin connector at BA6

Replacement Note: The speaker wires must cross each other. So when the front of the sound enclosure is facing you, the left speaker wire connects to BA5, and the right speaker wire connects to BA6.



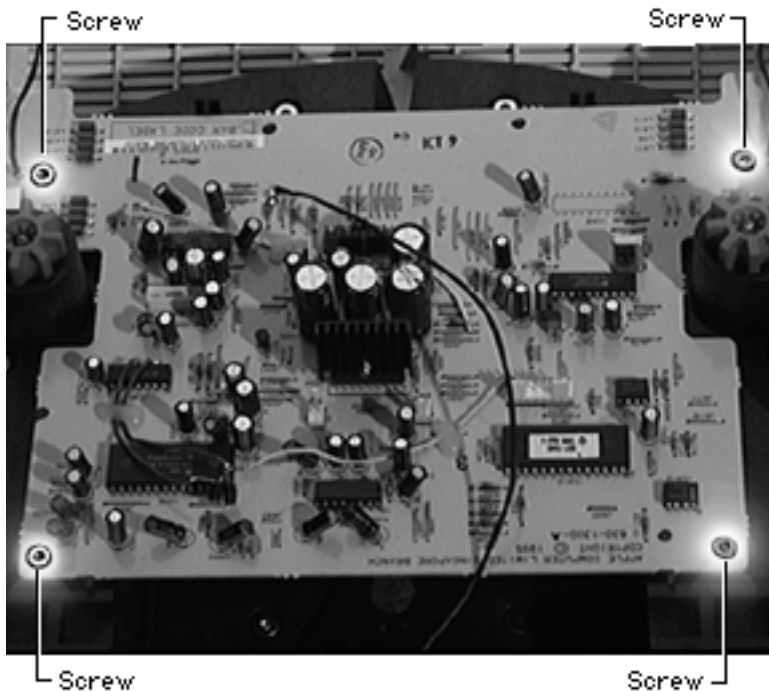

- 2 Remove the four T-15 torx screws from the sound board.
- 3 Lift the board off of the sound enclosure.



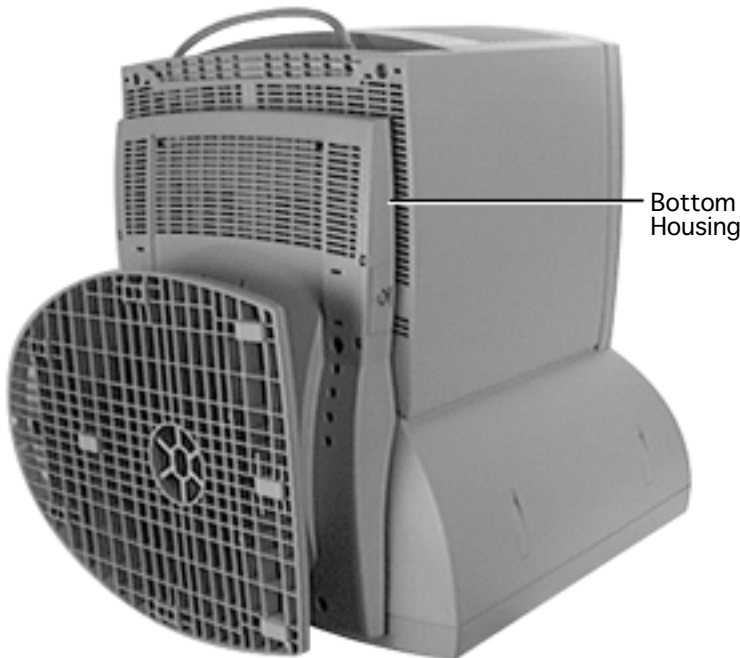

Bottom Housing (750 only)

No preliminary steps are required before you begin this procedure.

⚠ Warning: This product contains high voltage and a high-vacuum picture tube. To prevent serious injury, review CRT safety in Bulletins/Safety.

- 1 Place the monitor face down on a protective pad.





- 2 Position the tilt-swivel base sideways and so it is resting over a table edge.
- 3 Slide the tilt-swivel base down and remove the two T-15 torx screws above the tilt-swivel base.



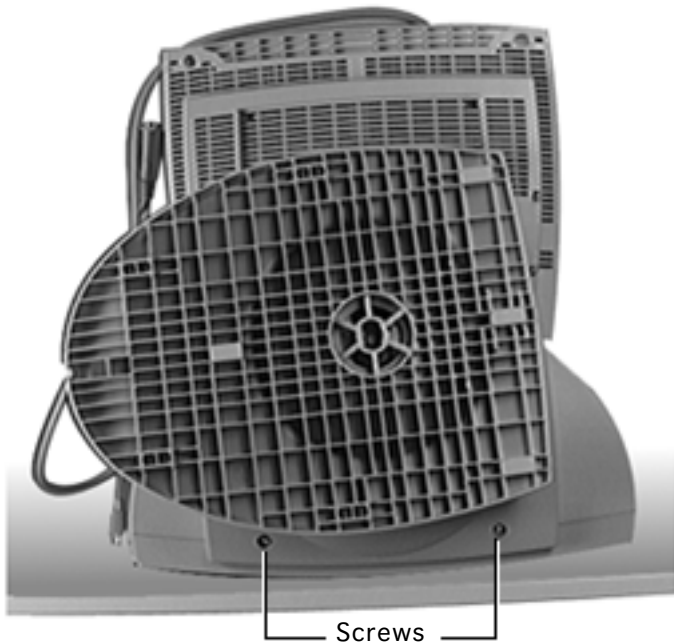

- 4 Slide the tilt-swivel base up and remove the two T-15 torx screws below the base.



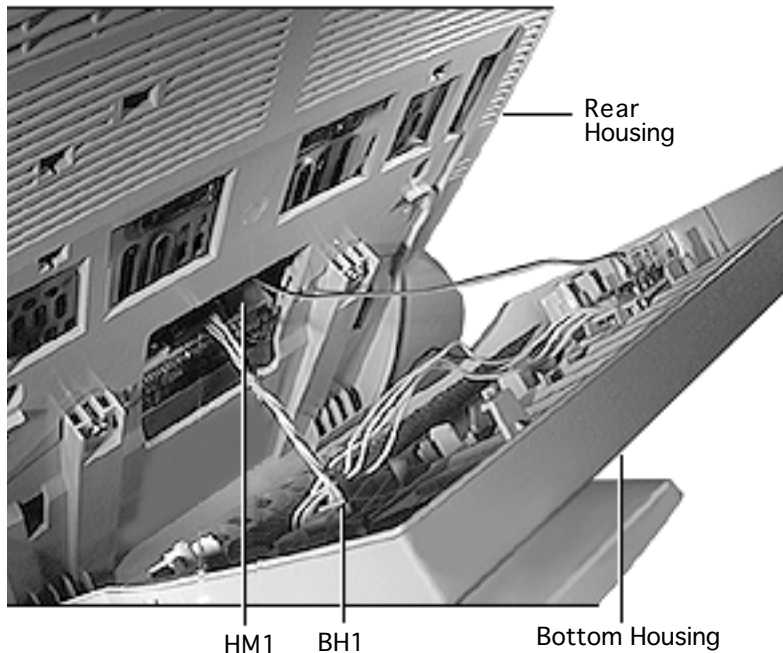

- 5 Tilt the bottom housing away from the rear housing.
- 6 Disconnect the 4-pin connector at BH1 on the ADB board.
- 7 Disconnect the single-pin connector at HM1 on the intermediate board.
- 8 Remove the bottom housing.





ADB Board (750 only)

Before you begin, remove the bottom housing.

Note: The ADB board consists of two boards joined together with a cable and soldered connections.

- 1 Press and hold the two tabs away from the ADB board.
- 2 Tilt the board up from the bottom housing to release it.

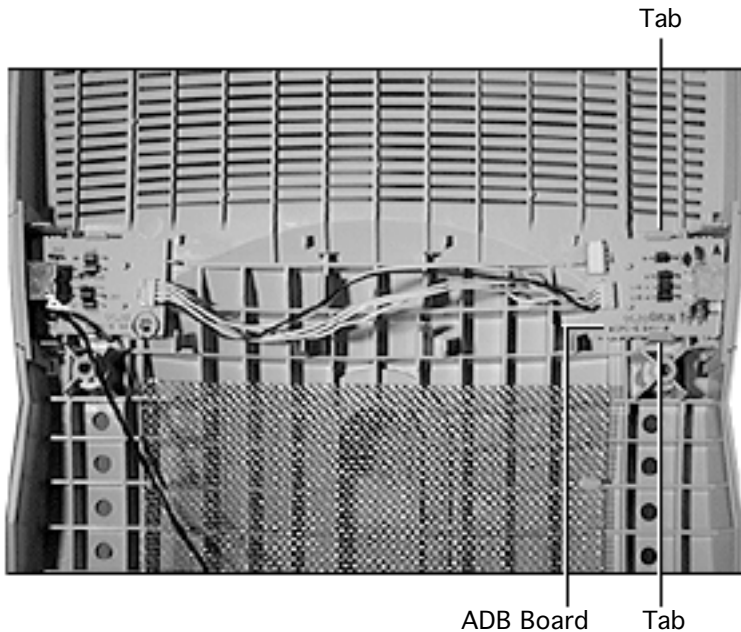



Replacement Note: Before securing the board tabs, position the ADB board so the plastic pins on the bottom housing line up with the holes in the board.



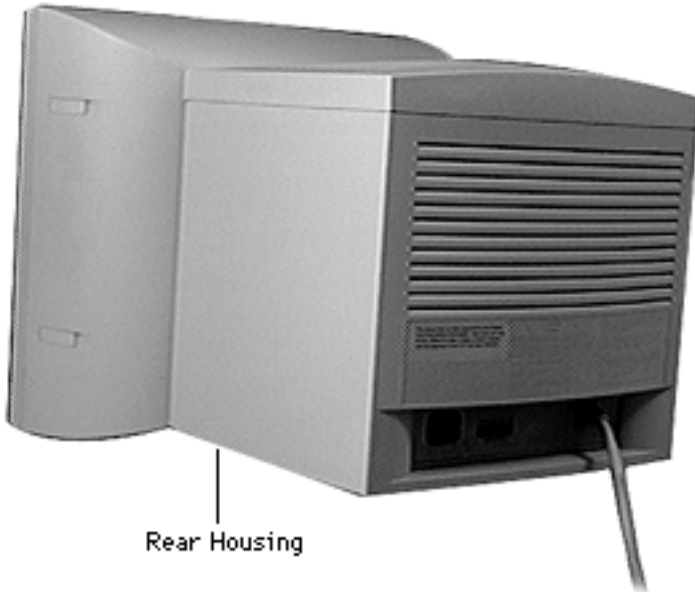

Rear Housing

Rear Housing

Before you begin, remove the following:

- Microphone assembly or blank plate
- Sound enclosure (750AV display)

⚠ Warning: This product contains high voltage and a high-vacuum picture tube. To prevent serious injury, review CRT safety in Bulletins/Safety.



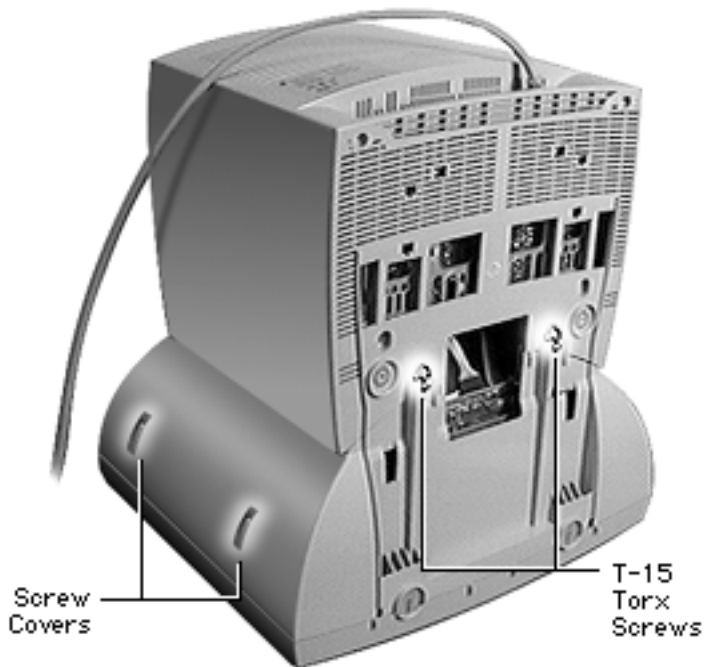

Important: You must remove the microphone assembly or blank plate and the sound enclosure before removing the rear housing.

- 1 With the monitor face down on a protective pad, remove the two T-15 torx screws and washers.
- 2 Locate the four screw covers.



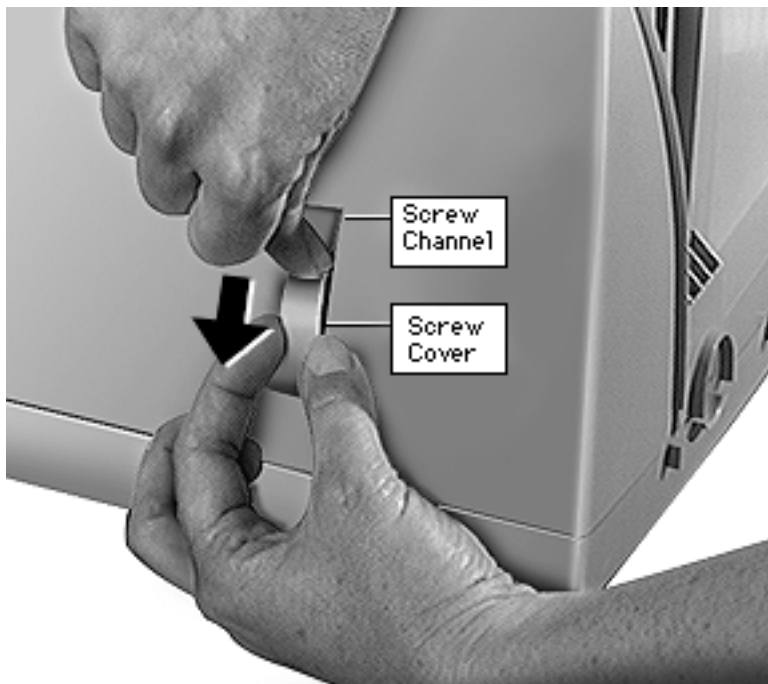

- 3 **Caution:** To avoid damaging the plastic housing or screw cover, don't use a screwdriver or other metal tool.

With one hand, press down on the tip of the screw cover, causing the screw cover to bow outward from the screw channel.

- 4 Pull out the screw cover with your other hand.
- 5 Repeat steps 3 and 4 for the remaining three screw covers.



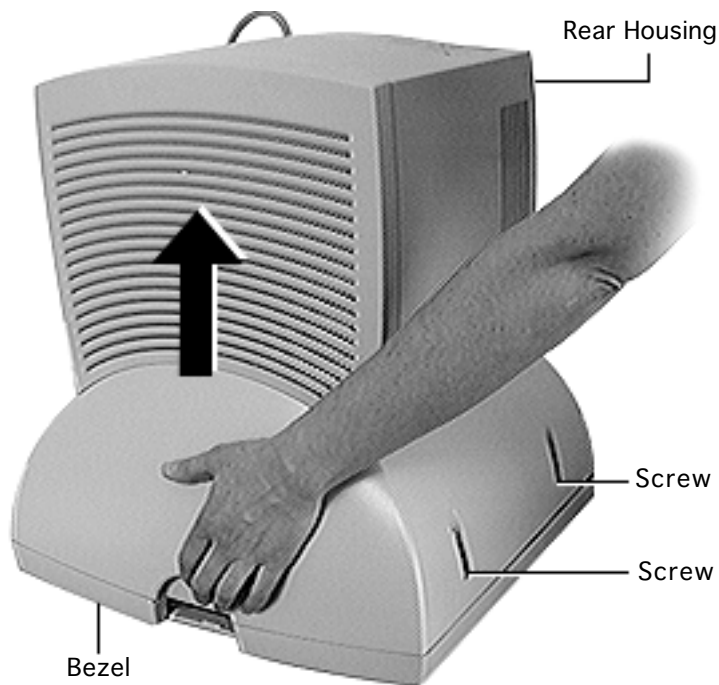

- 6 Remove the four T-15 torx screws.
- 7 Where the top part of the rear housing meets the bezel, pull up and out on the arched opening (at the microphone assembly/blank plate area) to release the rear housing tabs from the bezel.



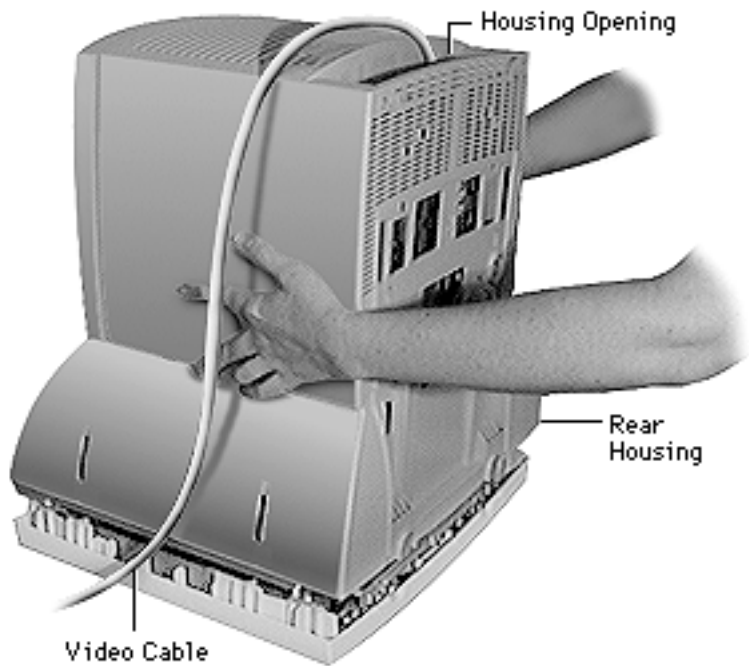

- 8 With both hands on the rear housing, lift it off the bezel.

Route the video cable through the housing opening.



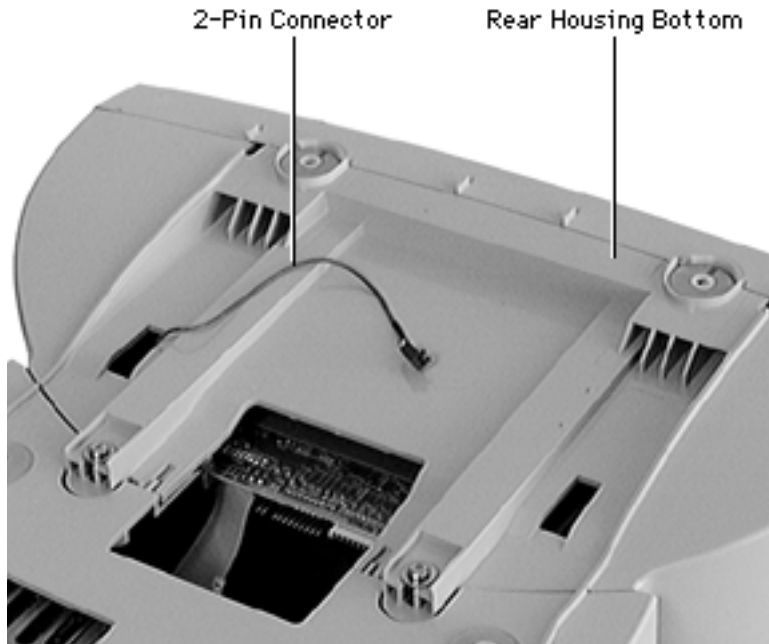

Replacement Note: For the AppleVision 750AV only, ensure that the 2-pin connector wire is routed through the rectangular opening in the rear housing before replacing the rear housing screws.





CRT/Video Board

Before you begin,

- Remove the microphone assembly/blank plate
- Remove the sound enclosure (750AV only)
- Remove the rear housing
- Discharge the CRT
- Download the setup parameters before replacing the CRT/video board (refer to the Troubleshooting chapter)

Caution: To avoid loss of data, you must download the display parameter

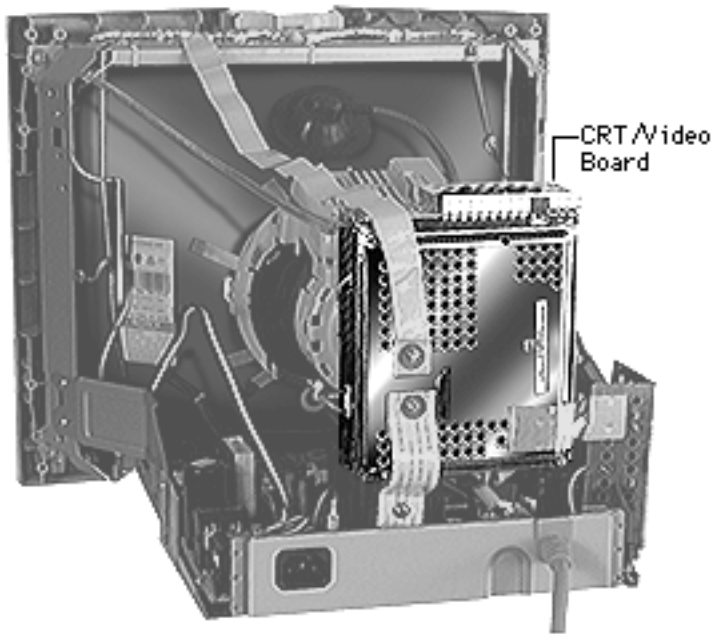



settings using the Display Service Utility before replacing the CRT/video board with a new board.

⚠ Warning: This product contains high voltage and a high-vacuum picture tube. To prevent serious injury, review CRT safety in Bulletins/Safety.

Caution: Never use a grounding wriststrap until after discharging the CRT.

Caution: When disconnecting cables from the CRT/video board, be careful not to apply excessive pressure to the neck of the CRT.



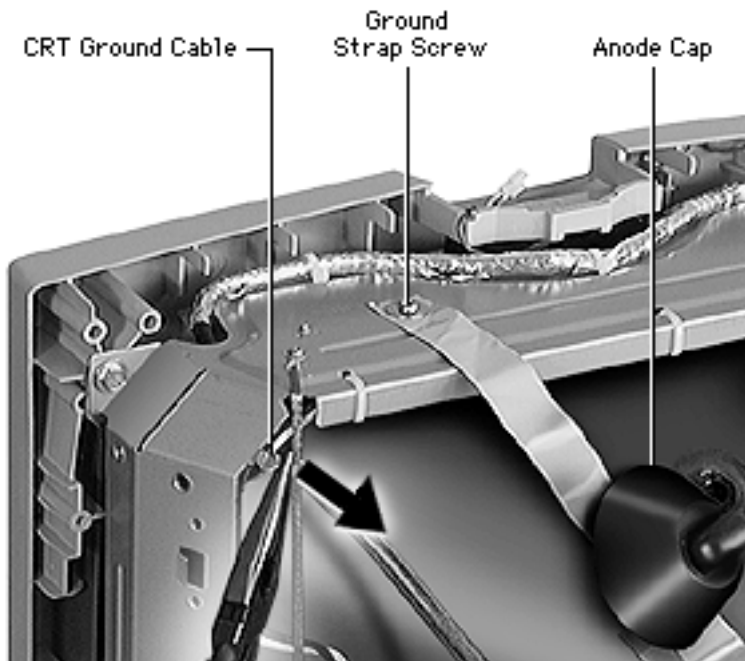

After discharging the CRT,

- 1 With needlenose pliers or a flat-blade screwdriver, disconnect the long braided CRT ground cable.
- 2 Use a Phillips screwdriver to remove the screw from the copper ground strap.
- 3 Remove the anode cap.



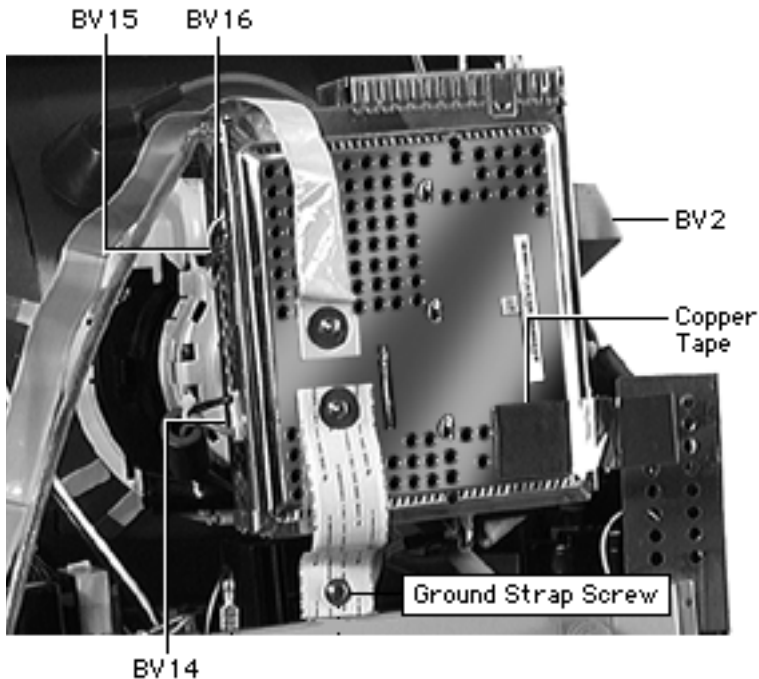

4 Disconnect

- BV14
- BV15
- BV16
- BV2 (ribbon cable)
- Copper tape
- Ground strap (Phillips screw)



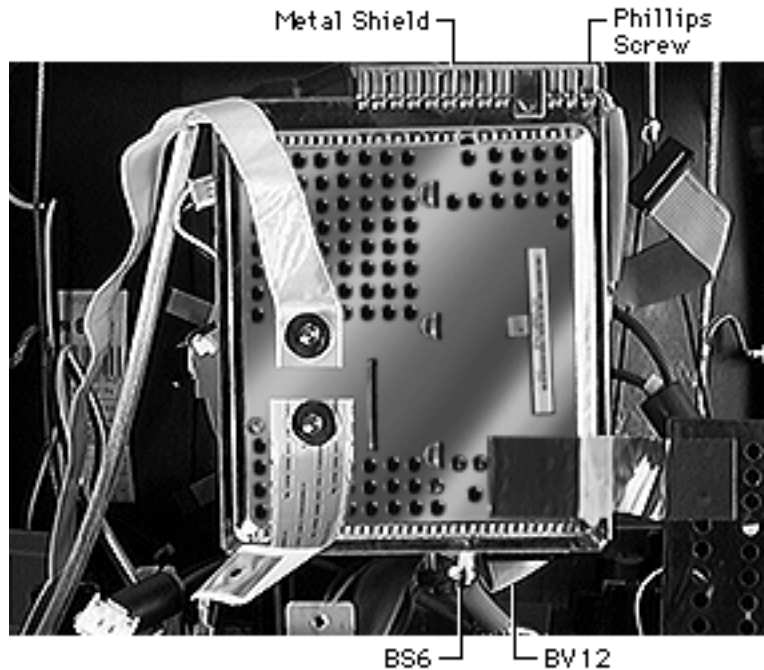

- 5 Disconnect these cables:
 - BV12 (ribbon cable)
 - BS6 (5-pin connector next to BV12)
- 6 Remove the single Phillips screw from the metal shield on top of the CRT/video board.
- 7 Remove the metal shield.



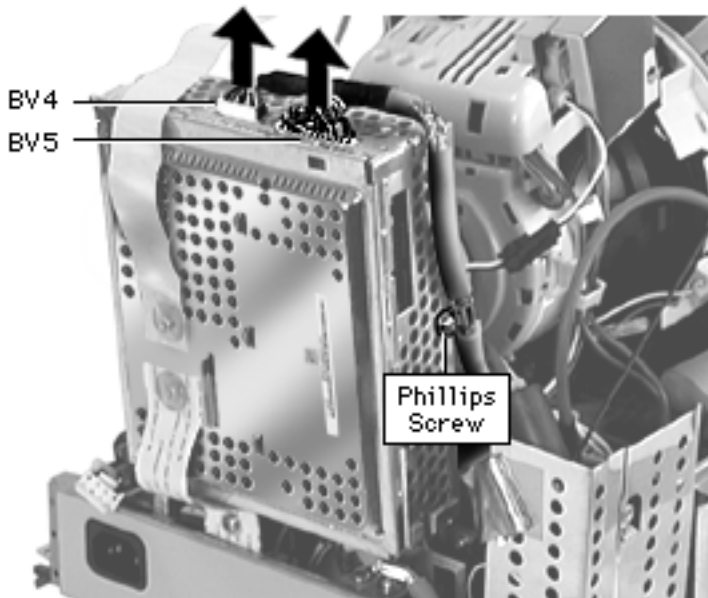

- 8 Disconnect the video cable at
 - BV4
 - BV3
- 9 Remove the Phillips screw that attaches the video cable clip to the CRT/video board.



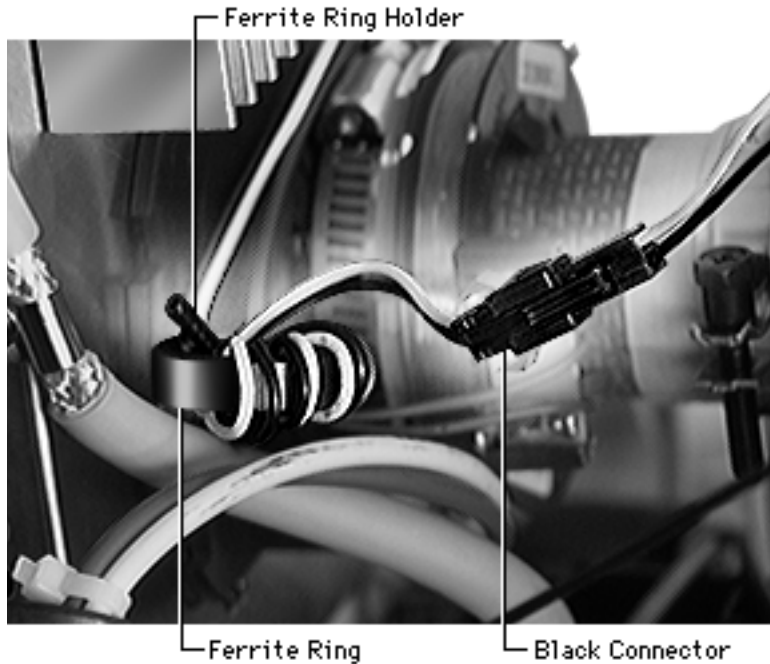

- 10 Disconnect the black connector near the ferrite ring.
- 11 Bend the wire of the ferrite ring holder to release the ferrite ring.



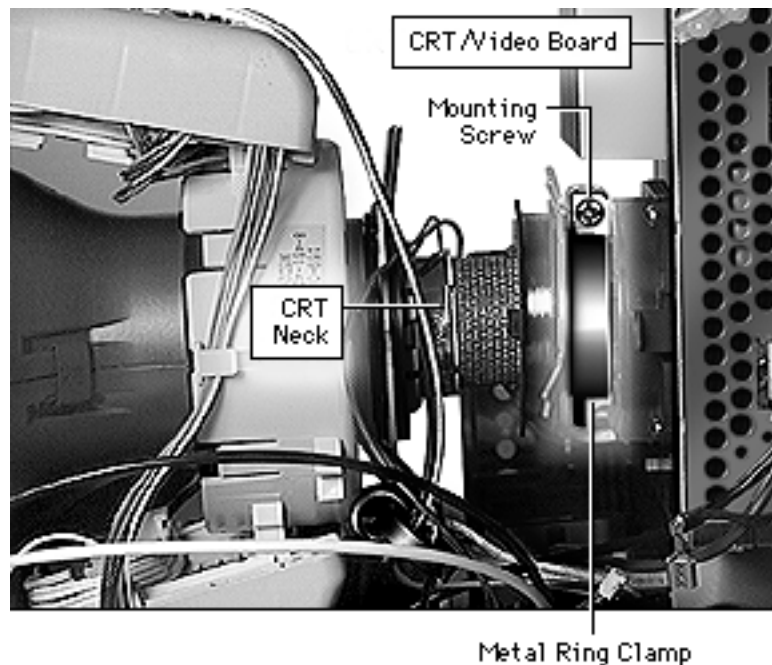

- 12 Loosen the flat-head mounting screw on the metal ring clamp that holds the CRT/video board to the CRT neck.



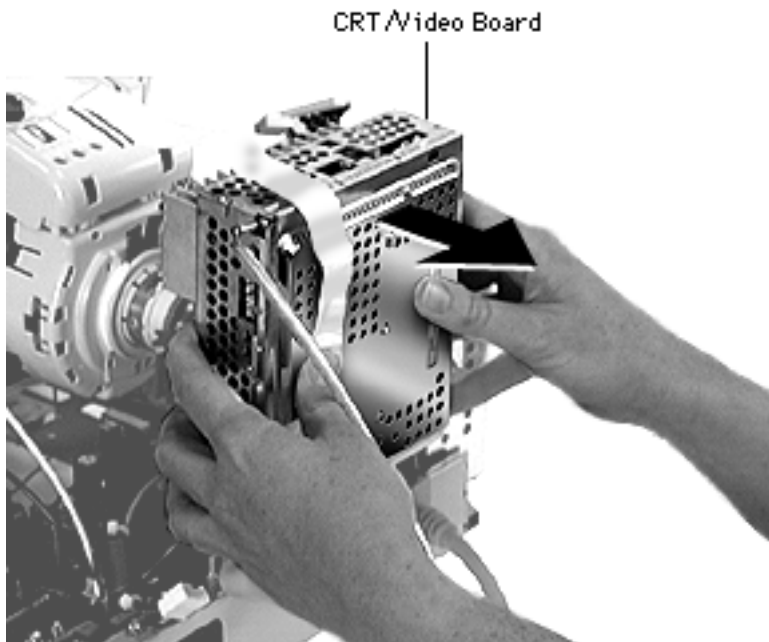

13 **Caution:** Twisting, bending, or applying force to the CRT/video board could damage the neck of the CRT.

With a gentle side-to-side motion, ease the CRT/video board off the neck of the CRT until it clears the neck pins.



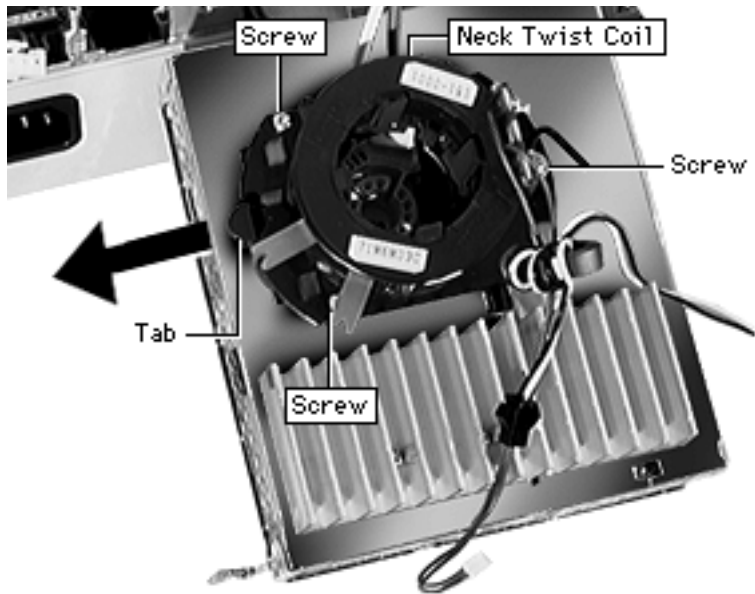

- 14 With the red and white flyback transformer wires still attached, remove the three Phillips screws from the neck twist coil.
- 15 Press the tab and slide the neck twist coil to the left and off of the CRT/video board.



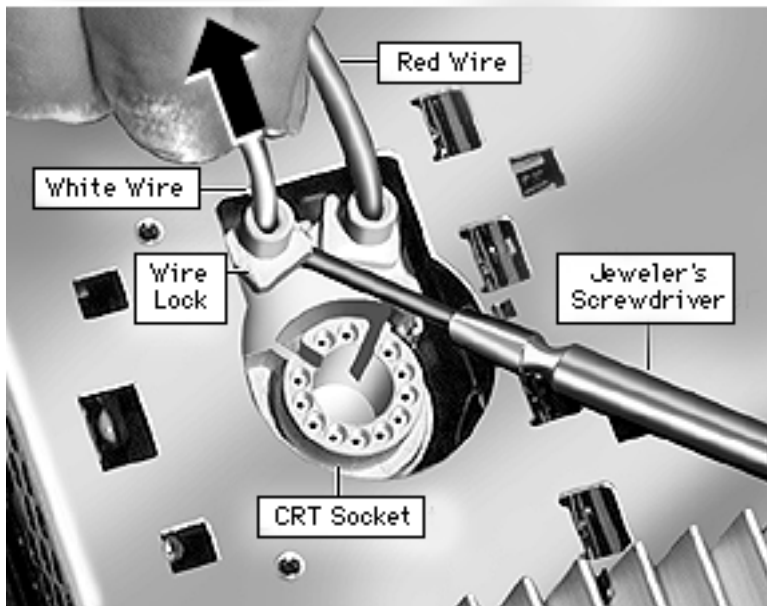

16 While holding, but not pulling, the red and white wires, use a jeweler's flat-blade screwdriver to tilt up the wire locks. Do not remove the wire locks from the CRT socket.

Replacement Note: Place the wires in the correct location as shown: red wire in the right wire lock and the white wire in the left wire lock. Check proper insertion by gently pulling the wires; they should not move.





Caution: If the wires are swapped or not pressed in far enough, the screen display will show poor focus.



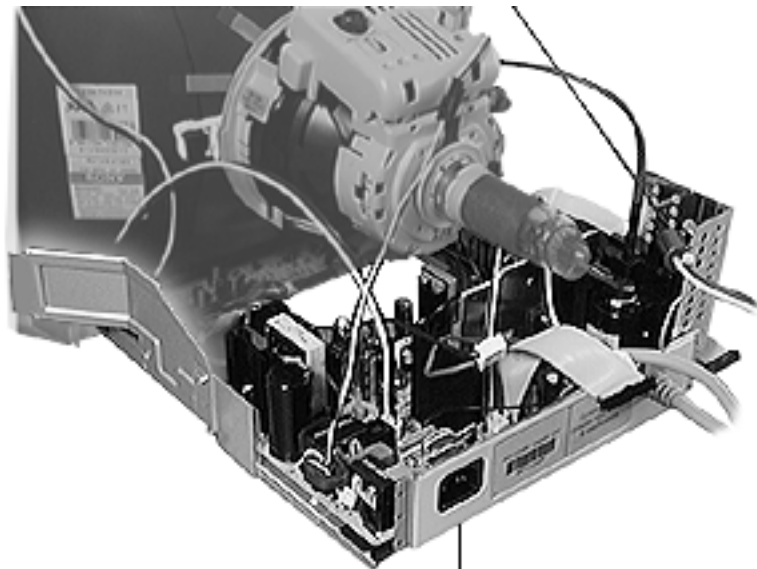

Main Deflection Board

Main Deflection Board

Before you begin,

- Remove the microphone assembly/blank plate
- Remove the sound enclosure (750AV only)
- Remove the rear housing
- Discharge the CRT
- Remove the CRT/video board

⚠ Warning: This product contains high voltage and a high-vacuum picture tube. To prevent serious injury,



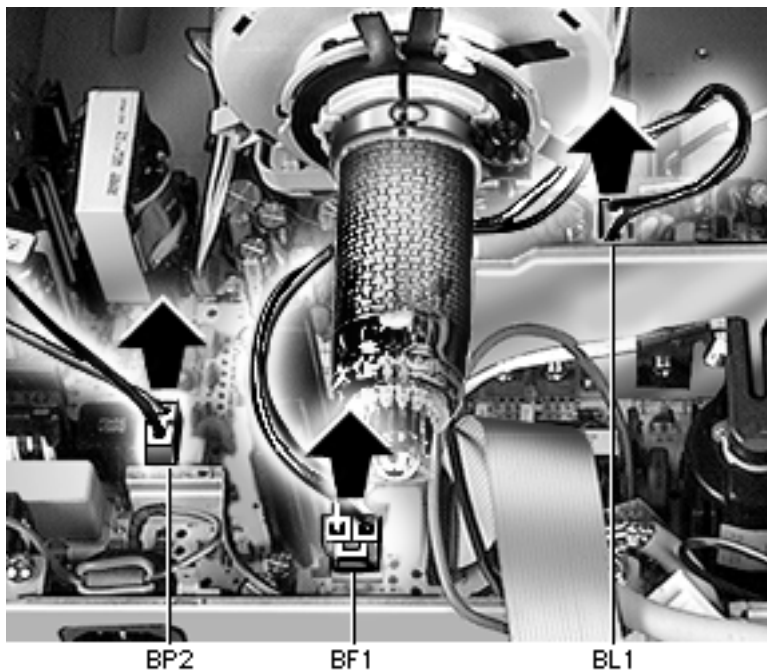

review CRT safety in Bulletins/Safety.

Caution: Never use a grounding wriststrap until after discharging the CRT.

- 1 Disconnect two-wire cable BP2 (black and white wires) from the main deflection board.
- 2 Disconnect the two yoke connectors
 - Red and blue wire at BL1
 - Yellow and brown wire at BF1



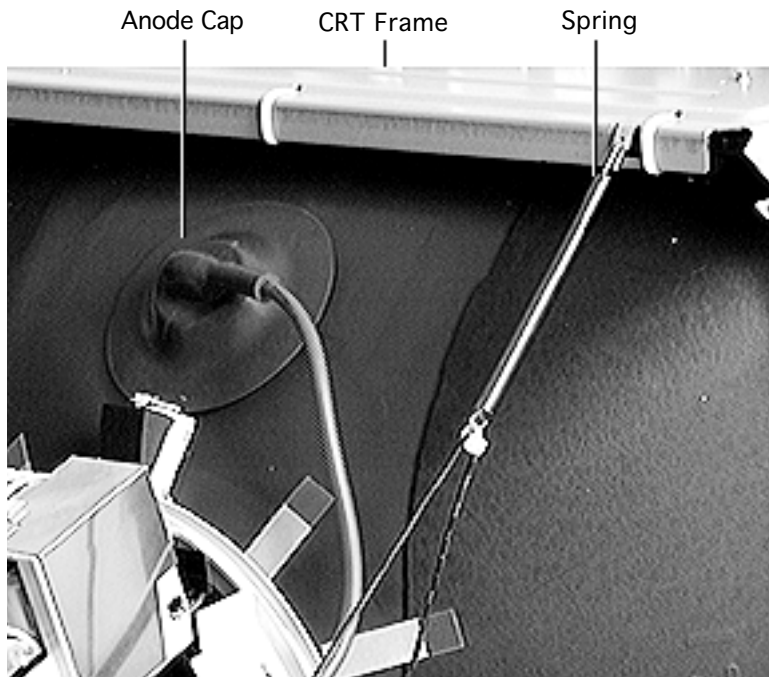

- 3 Disconnect the spring from the CRT frame.
- 4 Disconnect the anode cap.





Intermediate Board

BM4



- 5 Disconnect BM4 from the intermediate board.



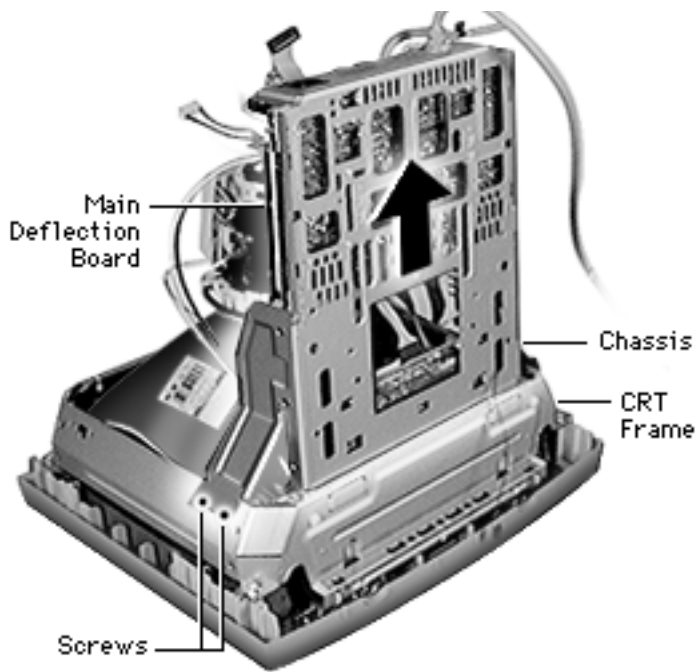

- 6 Place the monitor face down on a padded surface.
- 7 Remove the six Phillips screws that secure the chassis to the CRT frame.
- 8 Lift the main deflection board chassis straight off the CRT frame.



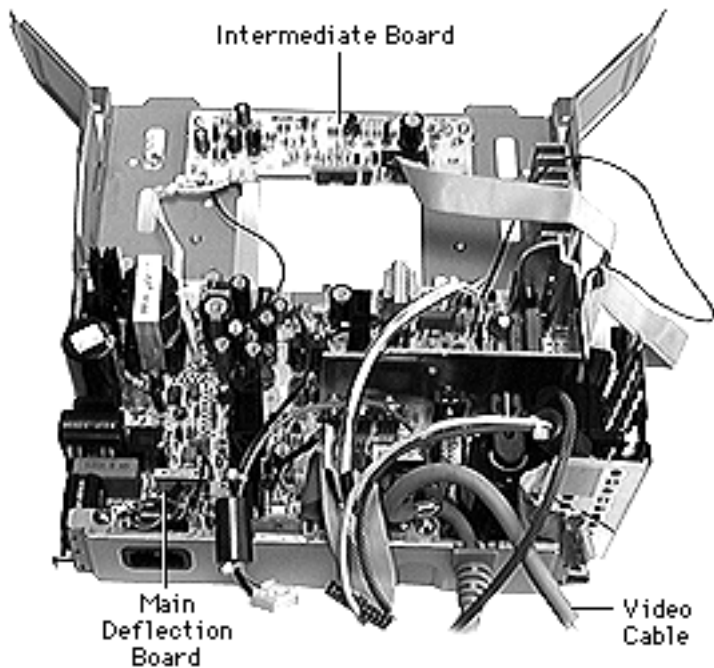

Replacement Note: The main deflection board module includes the main deflection board and chassis as one part. The intermediate board and the video cable are not part of the main deflection board module.





Intermediate Board

Important: Service data indicates this board rarely fails.

Before you begin,

- Remove the microphone assembly/blank plate
- Remove the sound enclosure (750AV only)
- Remove the rear housing
- Discharge the CRT
- Remove the CRT/video board
- Remove the main deflection board (chassis)

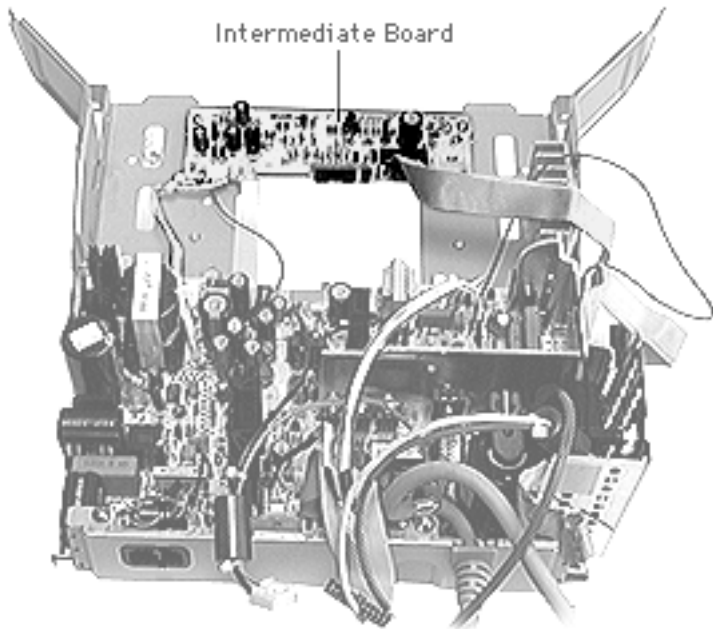

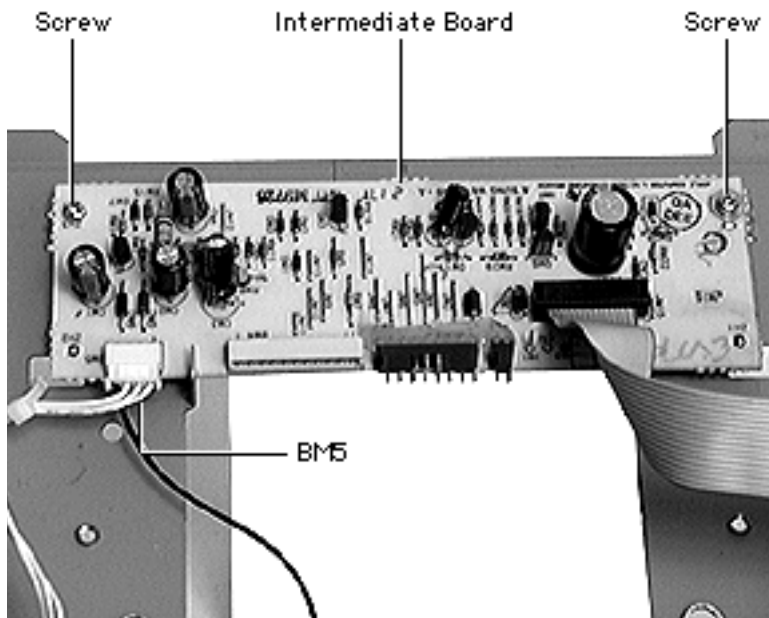

⚠ Warning: This product contains high voltage and a high-vacuum picture tube. To prevent serious injury, review CRT safety in Bulletins/Safety.

Caution: Never use a grounding wriststrap until after discharging the CRT.

- 1 Remove the two Phillips screws.
- 2 Disconnect the 4-pin connector at BM5.
- 3 Lift the intermediate board off of the chassis.



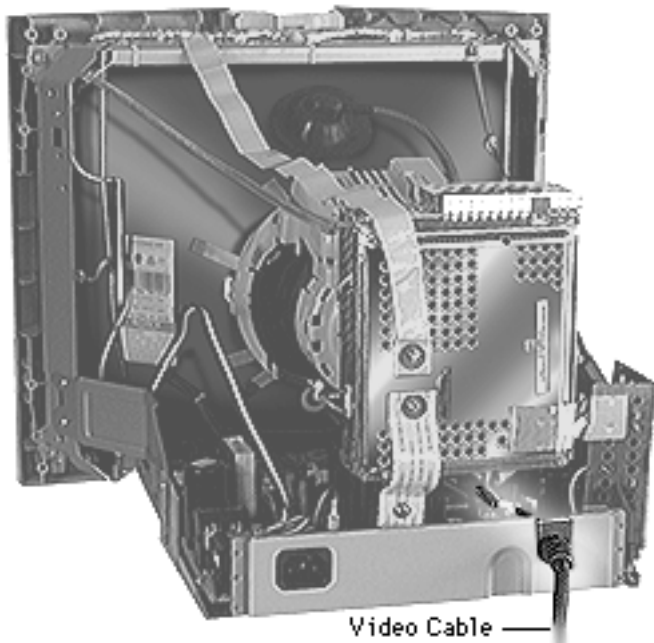

Video Cable and Strain Relief

Before you begin,

- Remove the microphone assembly/blank plate
- Remove the sound enclosure (750AV only)
- Remove the rear housing
- Discharge the CRT

⚠ Warning: This product contains high voltage and a high-vacuum picture tube. To prevent serious injury, review CRT safety in Bulletins/Safety.





Metal Shield
Phillips Screw

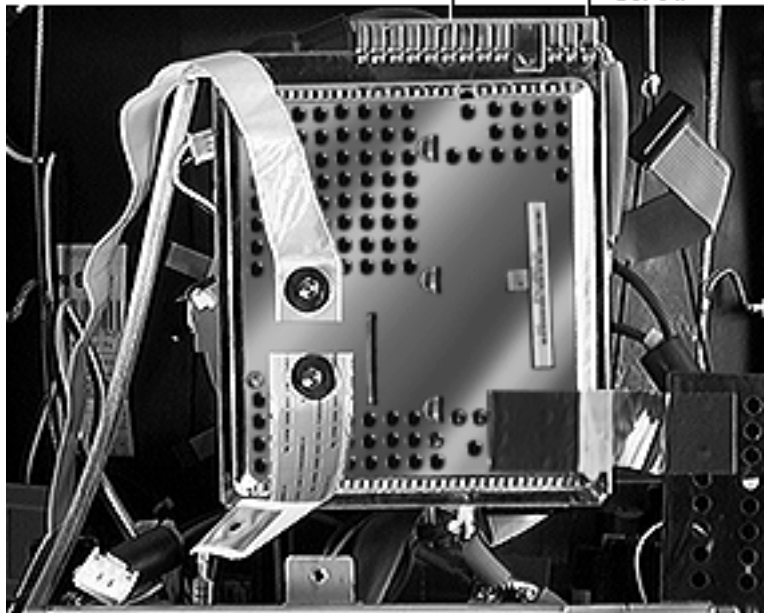

Caution: Never use a grounding wriststrap until after discharging the CRT.

- 1 Remove the single Phillips screw from the metal shield on top of the CRT/video board.
- 2 Remove the metal shield.



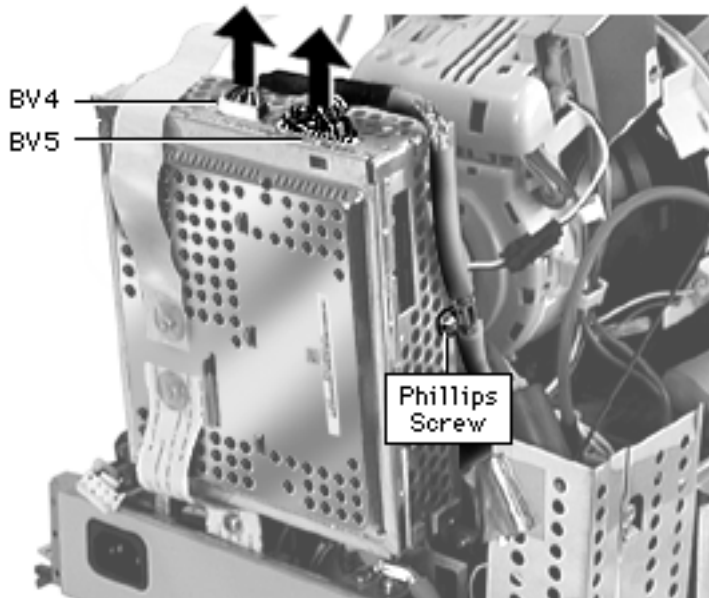

- 3 Disconnect the video cable at
 - BV4
 - BV5
- 4 Remove the Phillips screw that attaches the video cable clip to the CRT/video board.
- 5 Refer to “CRT/Video Board” in this chapter to remove the CRT/video board.



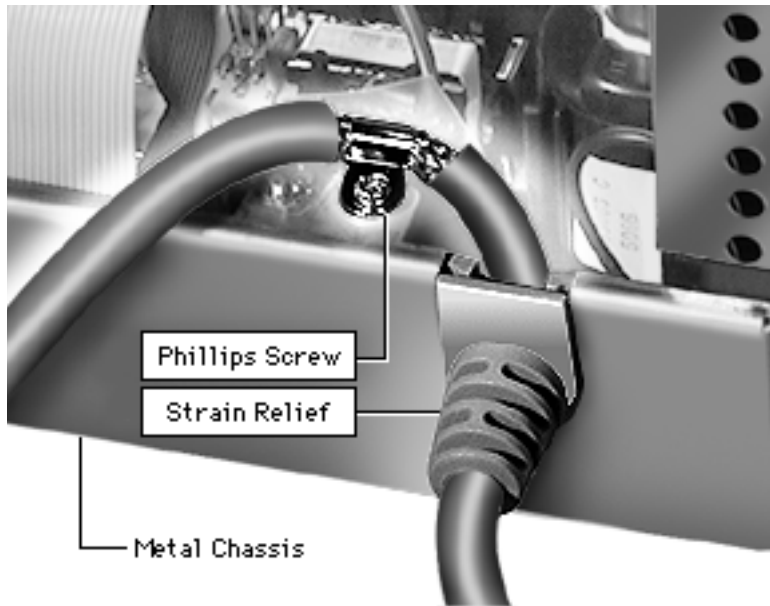

- 6 Remove the Phillips screw from the metal chassis.
- 7 Lift the strain relief straight out of the chassis slot.



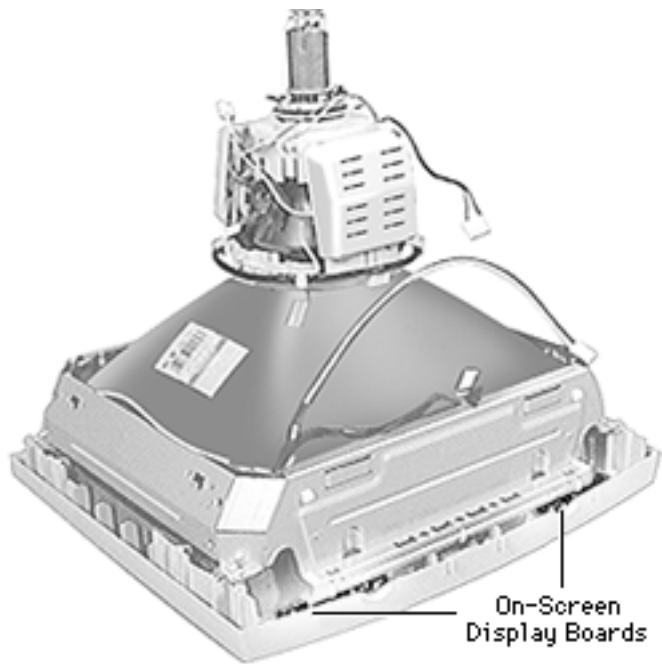

On-Screen Display Board

Before you begin,

- Remove the microphone assembly/blank plate
- Remove the sound enclosure (750AV only)
- Remove the rear housing
- Discharge the CRT
- Remove the CRT/video board
- Remove the main deflection board



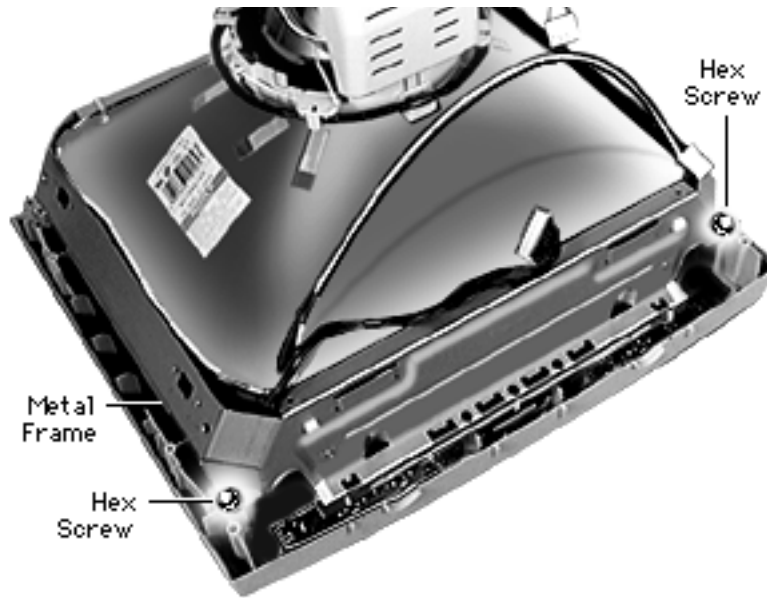

⚠ Warning: This product contains high voltage and a high-vacuum picture tube. To prevent serious injury, review CRT safety in Bulletins/Safety.

Caution: Never use a grounding wriststrap until after discharging the CRT.

- 1 With the CRT face-down on a padded surface, remove the 5/16-inch hex screws from the four corners of the CRT.



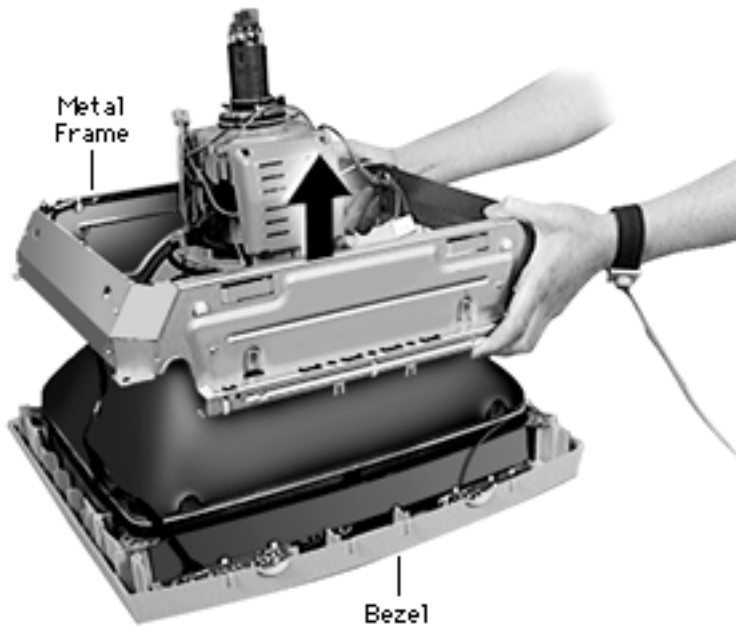

- 2 Lift the metal frame straight off of the bezel.



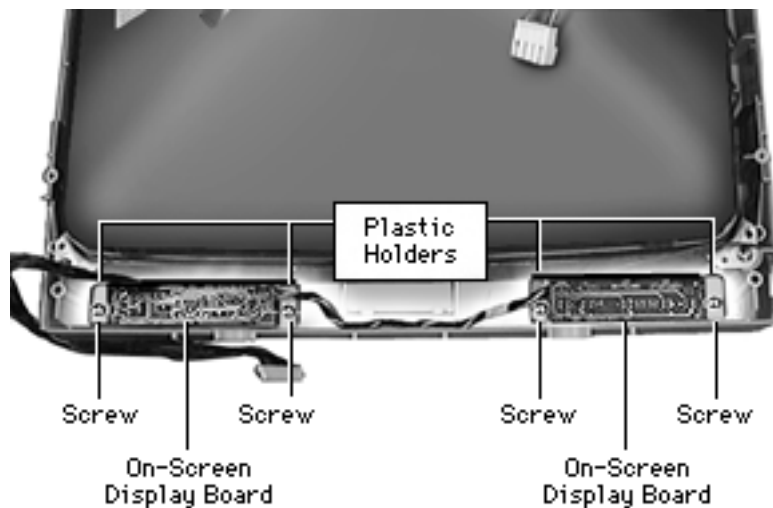

- 3 Use a 9/64-inch hex key to remove the four screws holding the on-screen control boards to the front bezel.
- 4 Lift the boards, including their plastic holders, straight up from the bezel.





Front Bezel

Before you begin,

- Remove the microphone assembly/blank plate
- Remove the sound enclosure (750AV only)
- Remove the rear housing
- Discharge the CRT
- Remove the CRT/video board
- Remove the main deflection board

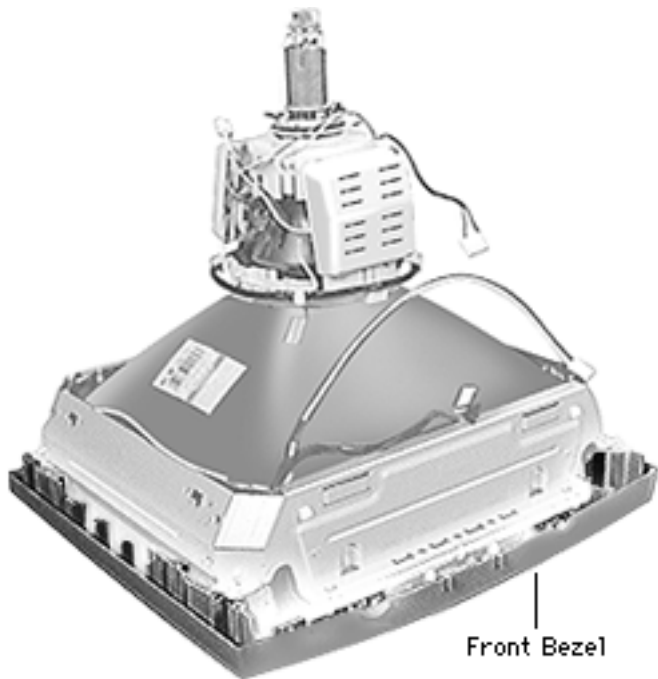

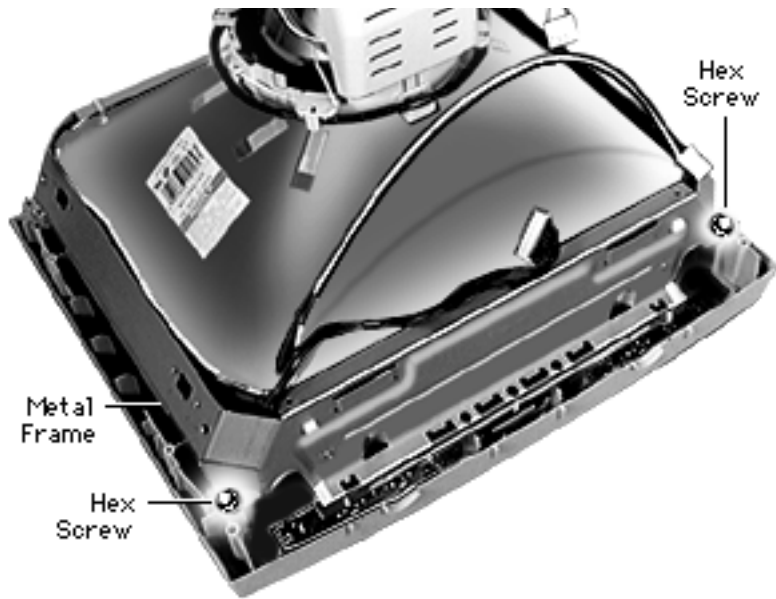

⚠ Warning: This product contains high voltage and a high-vacuum picture tube. To prevent serious injury, review CRT safety in Bulletins/Safety.

Caution: Never use a grounding wriststrap until after discharging the CRT.

- 1 With the CRT face-down on a padded surface, remove the four 5/16-inch hex screws.





- 2 Lift the metal frame straight off the bezel.

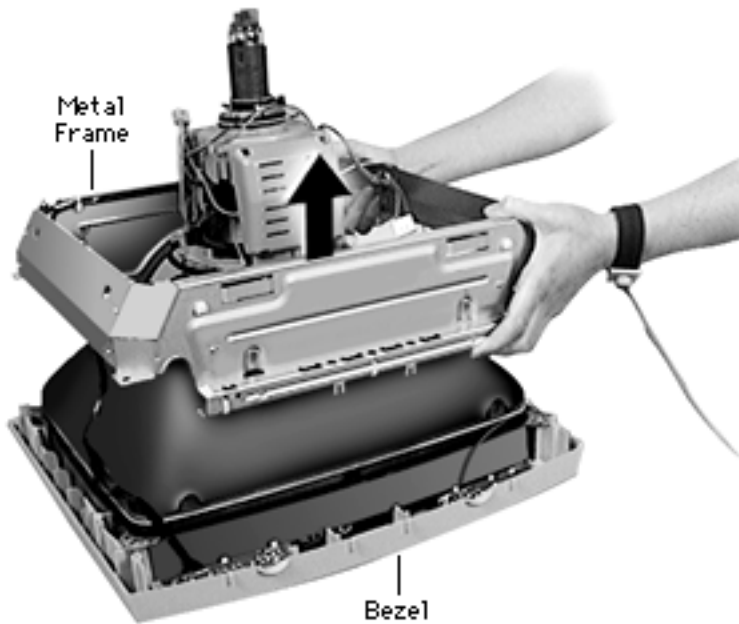



- Using both hands, lift the CRT off of the bezel.

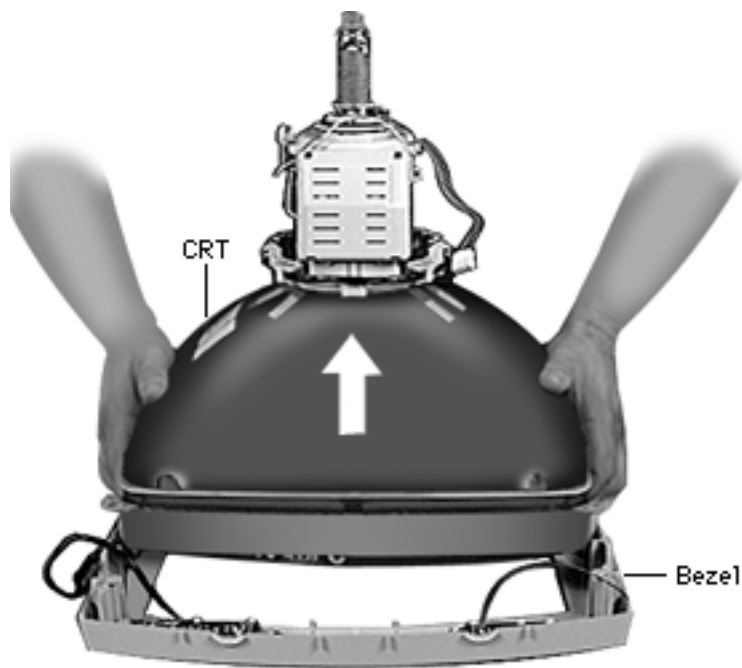

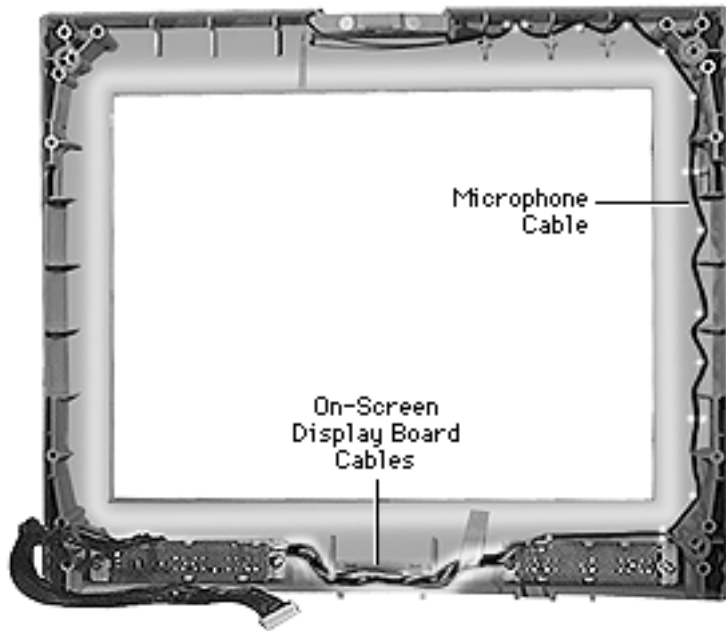

Replacement Note: Route the cables as shown when replacing the bezel.

Replacement Note: When replacing a TCO 95 front bezel for a ColorSync display, note that the microphone cable is not included nor required.





Adjustments

17" ColorSync Displays
(AppleVision 750, 750AV)





Introduction to the Monitors & Sound Control Panel

You can adjust the screen image using the buttons on the front of the display or you can use the Monitors & Sound control panel from AppleVision software. Most of the adjustment procedures require use of the Monitors & Sound control panel.

Important: For a complete description of the adjustments you can make using the Monitors & Sound control panel, refer to the following:

- For displays connected to computers using System 7.1, click the linked document “MonSound.pdf” at left.
- For computers using System 7.5 or later, refer to the Monitors & Sound Guide. The Monitors & Sound Guide is available in the Guide menu whenever the Monitors & Sound control panel is active. (The Guide menu symbol



MonSound.pdf





looks like a question mark; it appears in the upper-right corner of the screen.

Before you begin, make sure you have installed the AppleVision software and have connected the monitor cable's ADB connector to your computer's ADB port.

If you need more information or you are using the monitor with a Windows-based computer, refer to the AppleVision Display user's manual for the AppleVision 750 and 750AV. Click the icon at left to open the user's manual.



AppleVision750AVum.pdf





From the Monitors & Sound control panel, you can select six main buttons: Monitor, Arrange, Sound, Alerts, Geometry, and Color. From these buttons, you can make the following adjustments:

Monitor	Arrange	Sound	Alerts	Geometry	Color
Color Depth Resolution Contrast Brightness	Configure more than one monitor	Sound Input Sound Output Volume Quality	Change computer's alert sound	Height/Width Position Pincushion Rotate Keystone Parallelogram Convergence Overscan Factory Settings	White Point Gamma Curve Ambient Light Import/Export Preferences Recalibrate

From the AppleVision 750AV Monitors & Sound control panel, you can select an additional button: Monitor Sound.





The Monitor Sound button controls the monitor's internal speakers and devices connected to the AppleVision 750AV Display. (This button is not available in the Monitors & Sound control panel for the AppleVision 750 Display.)

Note: The remainder of this chapter covers some of the tools available from the Monitors & Sound control panel. For more thorough information, refer to the Monitors & Sound Guide or the linked documents.





Monitors & Sound Control Panel

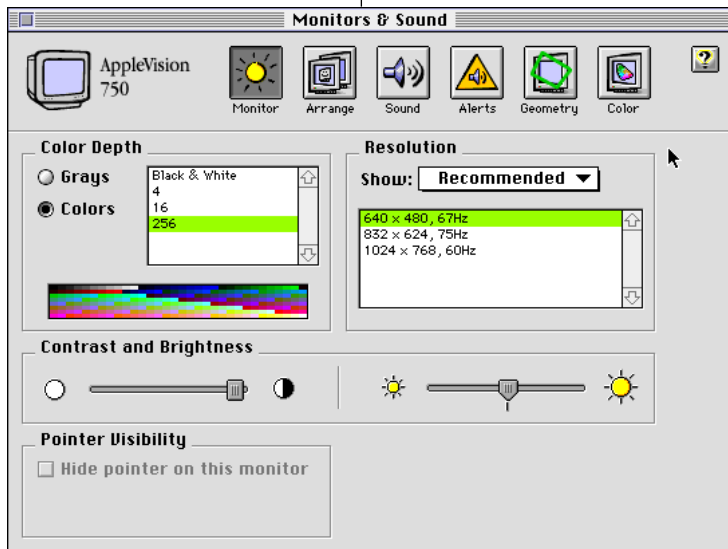

Brightness and Contrast

Before you begin, install the AppleVision software.

Note: There are two ways to adjust the brightness and contrast. You can use the controls on the right side of the front panel, or you can use the Monitors & Sound control panel.





Brightness

To use the front panel brightness controls,

- Press the down button to decrease the brightness.
- Press the up button to increase the brightness.

Brightness Controls

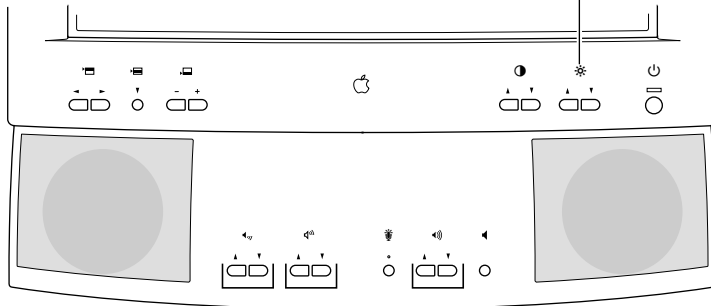



Contrast

To use the front panel contrast controls,

- Press the down button to decrease the contrast.
- Press the up button to increase the contrast.

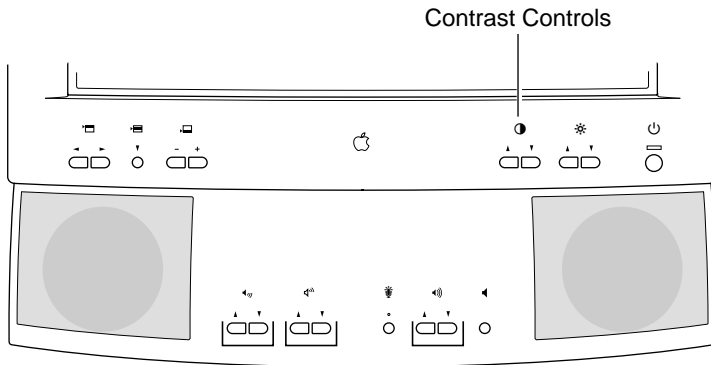



Using Monitors & Sound

To use the Monitors & Sound control panel to adjust brightness and contrast,

- 1 Press any control button to open the Monitors & Sound control panel. Or select Control Panels from the Apple menu, and select Monitors & Sound.

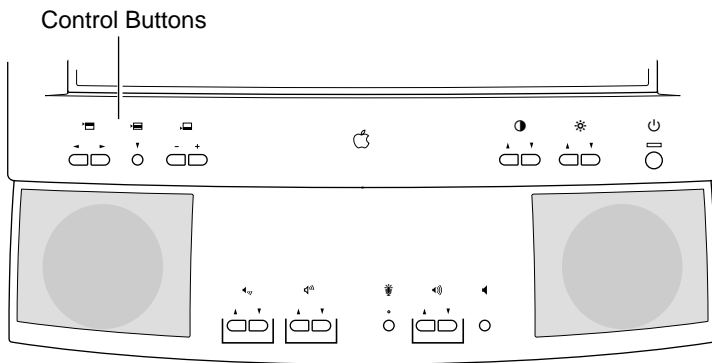



- 2 Click the Monitor button.

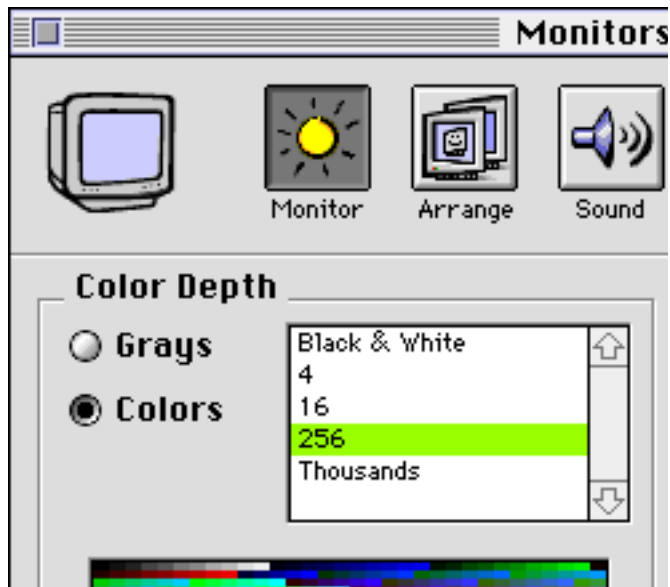

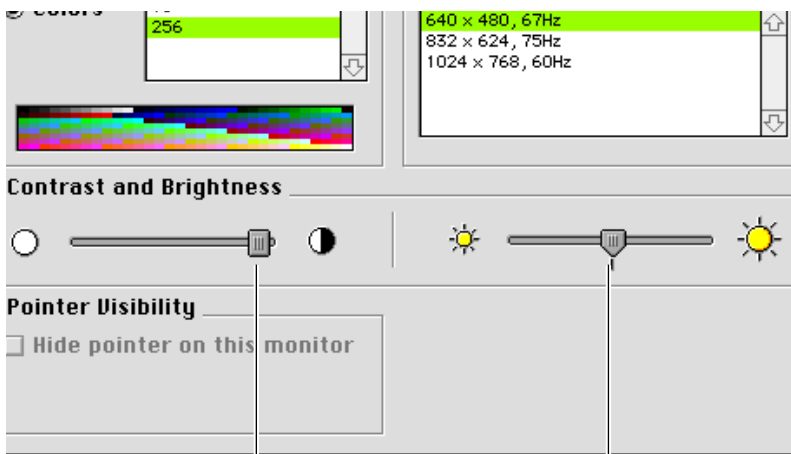

Slider Control

Slider Control

- 3 Drag the slider controls left or right to decrease or increase the brightness and contrast.





Geometry

- 1 Press any control button to open the Monitors & Sound control panel. Or select Control Panels from the Apple menu, and select Monitors & Sound.
- 2 Click the Geometry button.

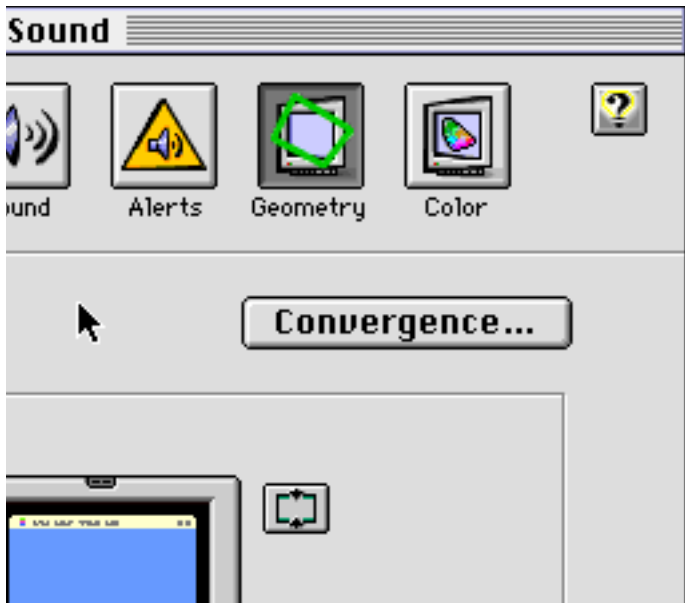



Height/Width



Height/Width

- 1 Click Height/Width.
- 2 Move the pointer over the screen rectangle in the picture of the display.
- 3 Drag the left or right side of the screen rectangle to change the width.
- 4 Drag the top or bottom edge of the screen rectangle to change the height.



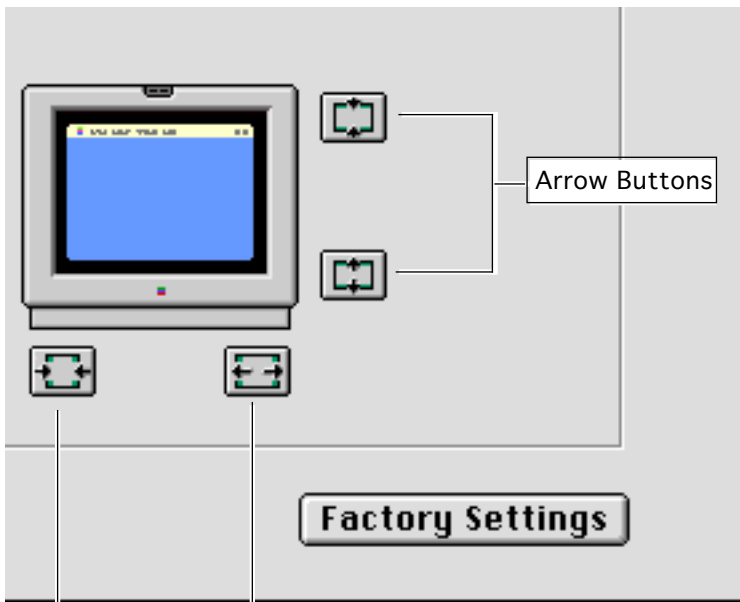

Note: Instead of dragging the screen rectangle, you can adjust height and width by clicking the arrow buttons for incremental movement.

Normal height and width leaves a black border of approximately 1/2-inch around the screen image.

Arrow Buttons



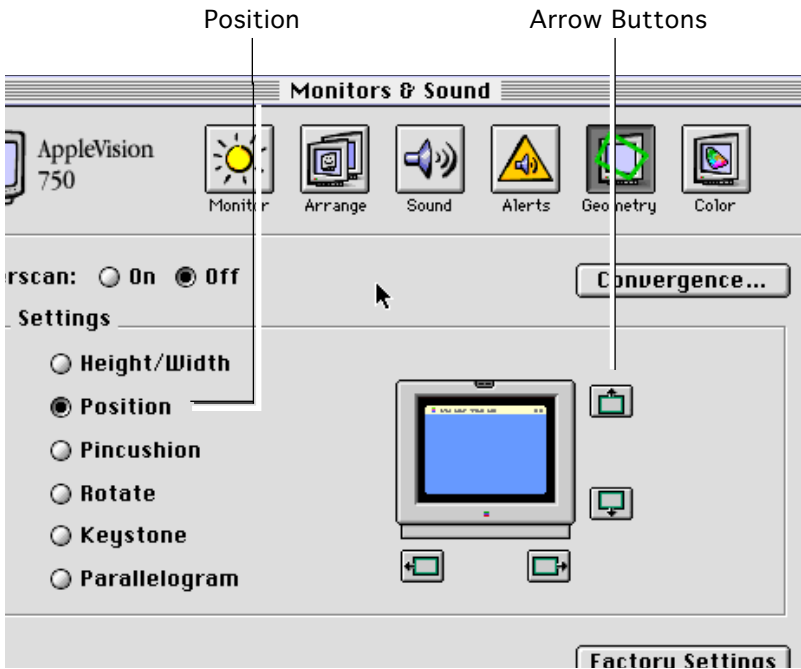

Position (Centering)

- 1 Click Position.
- 2 Move the pointer over the picture of the display.
- 3 Drag the screen rectangle to center the image.

Note: Instead of dragging the screen rectangle, you can also adjust height and width by clicking the arrow buttons for incremental movement.





Pincushion

Arrow Buttons

Pincushion

- 1 Click Pincushion.
- 2 Move the pointer over the picture of the display.
- 3 Drag the left or right side of the screen rectangle to adjust the image.

Note: Instead of dragging the screen rectangle, you can adjust the shape of the image by clicking the arrow buttons for incremental movement.



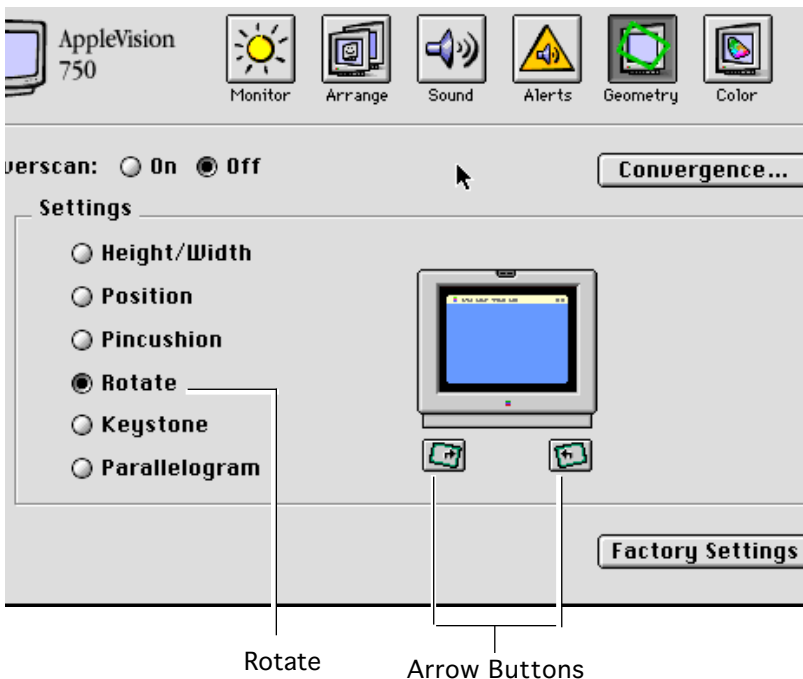

Rotating

- 1 Click Rotate.
- 2 Move the pointer over the picture of the display.
- 3 Drag the screen rectangle clockwise or counterclockwise to rotate the image.

Note: Instead of dragging the screen rectangle, you can rotate the image by clicking the arrow buttons for incremental movement.





Convergence

- 1 If you want to adjust the RGB color convergence, click the Convergence button. A Convergence Control window appears.

Note: When you adjust convergence, refer to the center of the screen on the grid outside the Convergence Control window. If necessary, move the window away from the center of the screen.





- 2 Click the arrow buttons to adjust convergence. Adjust convergence for the overall best screen color clarity.

Note: The active range for the horizontal convergence controls varies from unit to unit. In most cases there is a portion of the range that has no affect.

If the horizontal controls seem stuck, move the controls in one direction a large extent and if no affect is seen, move them in the other direction a large extent until a change is detected. Moving back and forth in small increments will have no affect until the controls are moved into the active range.

- 3 Click OK to save your convergence changes and close the Convergence Control window.

Note: If focus is poor after adjusting convergence, refer to the Focus symptom in the Troubleshooting chapter.



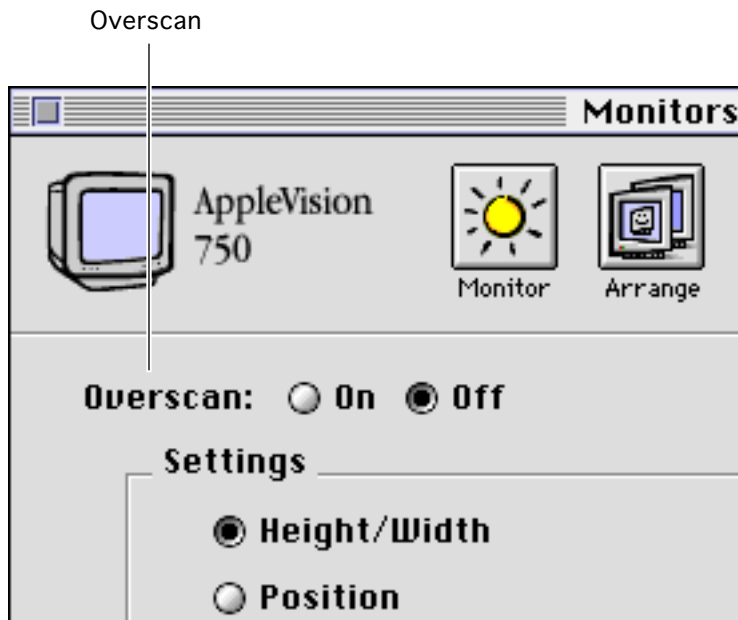

Overscan

Note: Overscan is typically used when viewing a movie or when you want the screen image to span the entire screen area (exceeding the limit of the raster).

- 1 To turn overscan on, click On.

Important: When overscan is on, you cannot adjust screen geometry or convergence, and you might not be able to choose commands from the menu bar at the top of the screen.



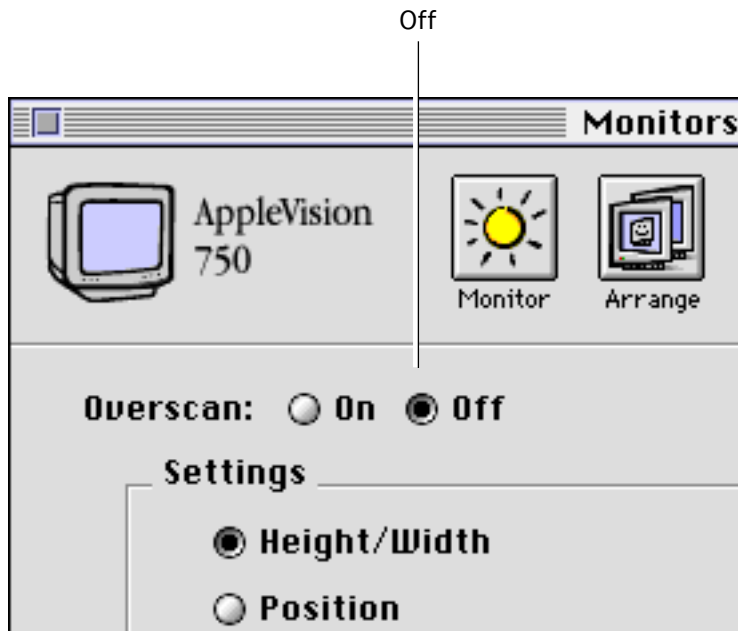

- 2 To turn overscan off, click Off, and the screen image returns to its previous size.





Factory Settings

Important: Clicking the Factory Settings button resets only the geometry controls and convergence. The screen image returns to the factory preset levels of geometry and convergence for the current screen resolution. Adjustments you make in the Monitor, Color, or Sound windows are not reset.





Color

- 1 Press any control button to open the Monitors & Sound control panel. Or select Control Panels from the Apple menu, and select Monitors & Sound.
- 2 Click the Color button.

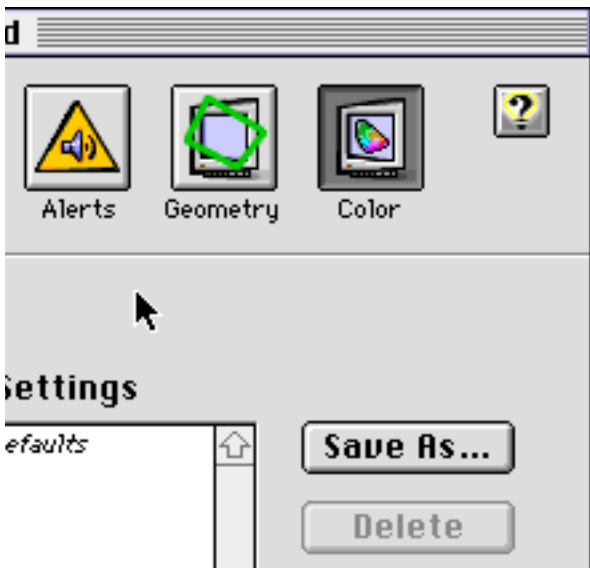



Refer to the Monitors & Sound Guide within AppleVision software for specific color adjustments.

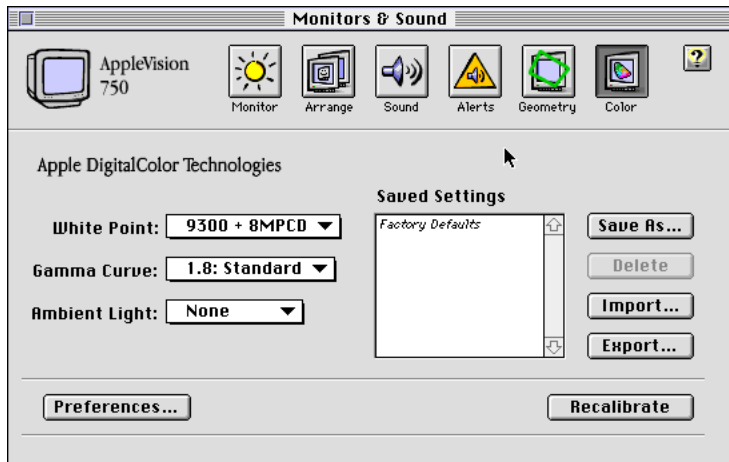



Sound (750AV only)

Before you make changes to the Sound window of Monitors & Sound, choose Control Panels from the Apple menu. Open the Sound control panel to select a sound input source, select a sound output device, and adjust volume.

Refer to Chapter 3, “Using Sound and Video,” from the user’s manual (a linked document) for more information.





The Control Strip

The control strip is a line of small icons that appears when you turn on the AppleVision display.

The control strip allows you to make quick and easy changes to common settings such as screen resolution or color depth.





Changing Screen Resolution

To view or change the display's screen resolution,

- 1 Move the pointer over the checkerboard screen icon, and hold down the mouse button.
- 2 Select a screen resolution from the pop-up menu.

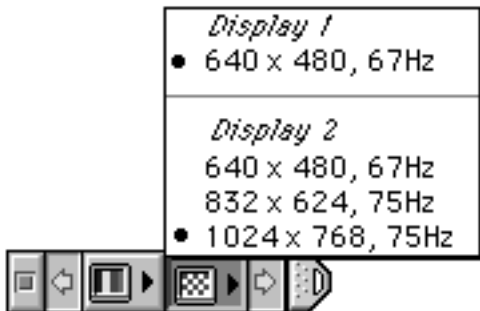

Note: The example shows what you might see if two displays were connected to your computer.



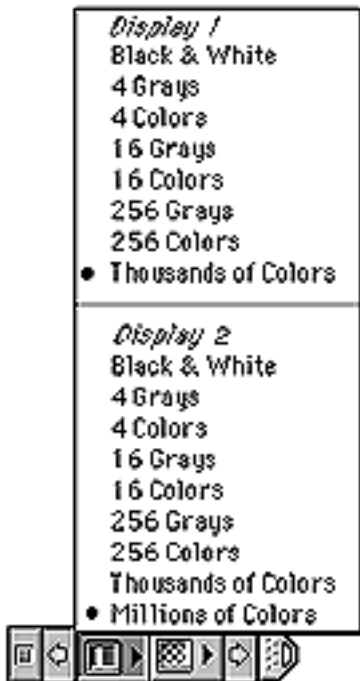

Changing Color Depth

To view or change the display's color depth,

- 1 Move the pointer over the striped screen icon, and hold down the mouse button.
- 2 Select a color setting from the pop-up menu.

Note: The example shows what you might see if two displays were connected to your computer.



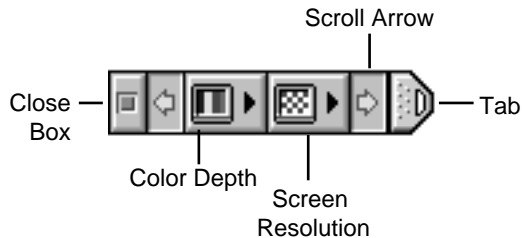

To...	Do this...
Close	Click close box or click tab
Open	Click tab
Resize	Click and drag tab
Move	Hold down Option key and drag tab
Hide	Press Shift-Control-C
Customize	Apple menu: Control Panels: Control Strip





Exploded View

17" ColorSync Displays
(AppleVision 750, 750AV)



