

(X) = Intersheet wiring
 (x) = Sheet terminated on

I.C.	TYPE	Pin 1	Pin 2	Pin 3
UB13	74 HC 74	14		7
UD13		14		7
UE13	74 HC 132			7

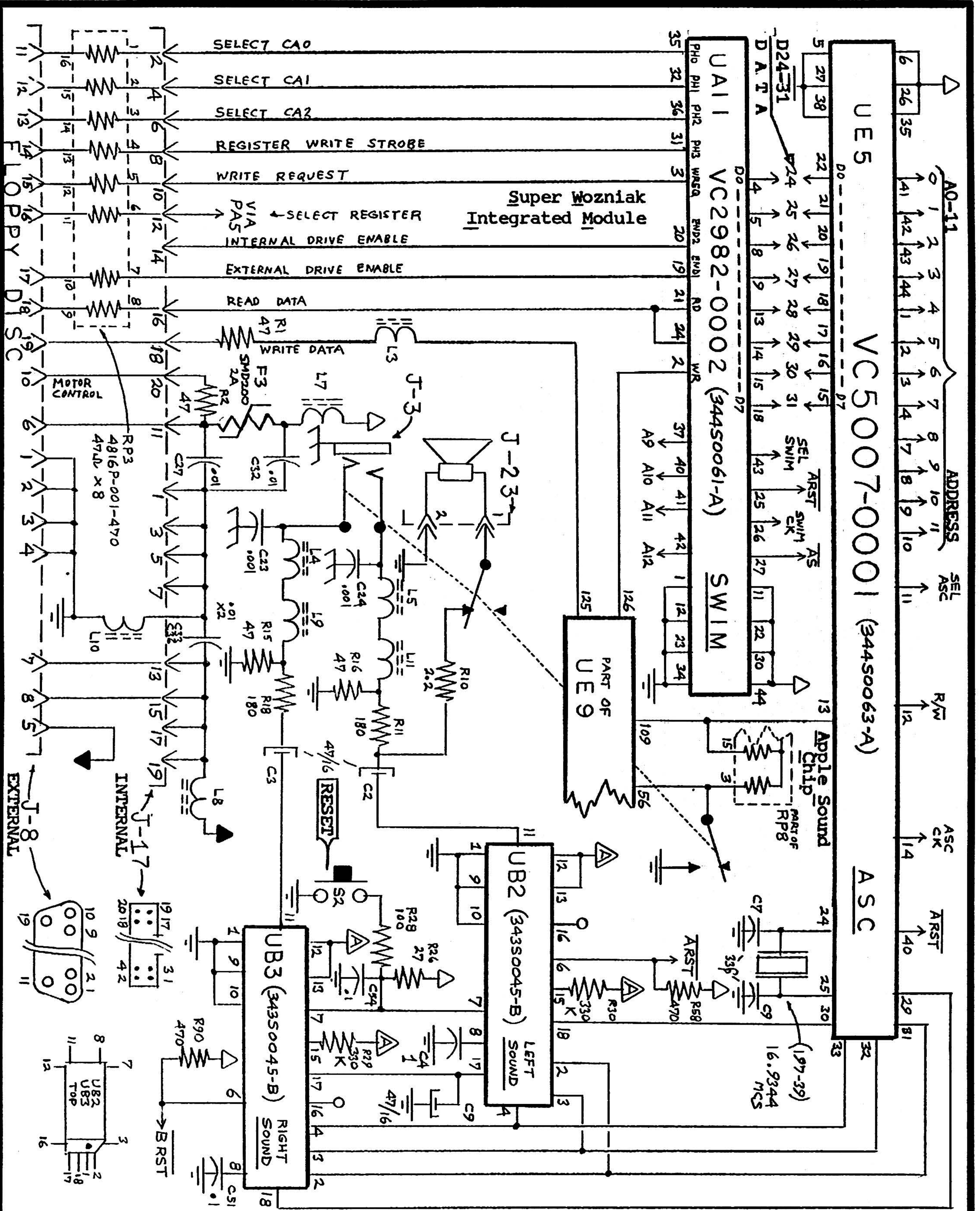

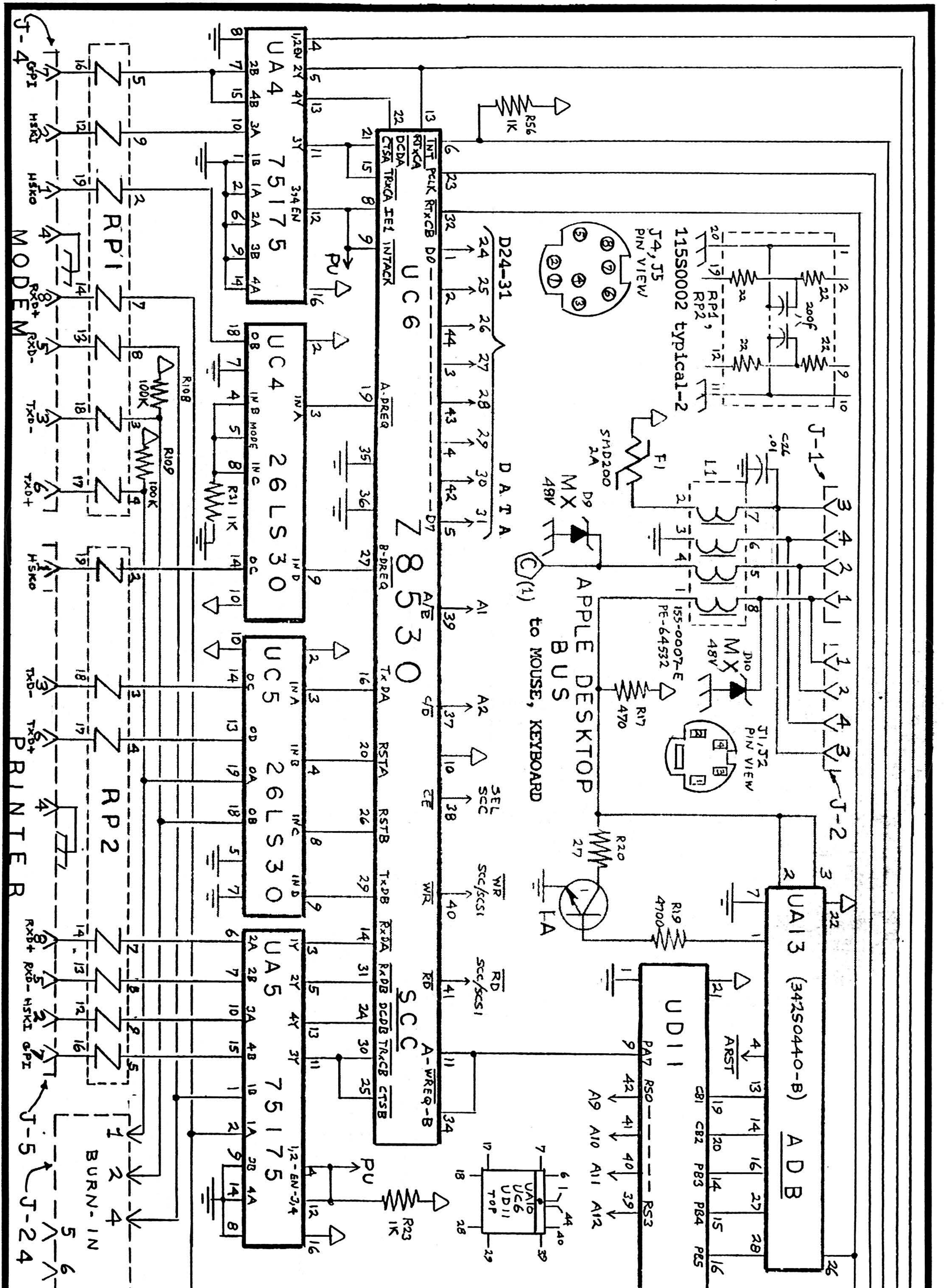

1A = MMBT3904
 MX = 1SMB48AT3

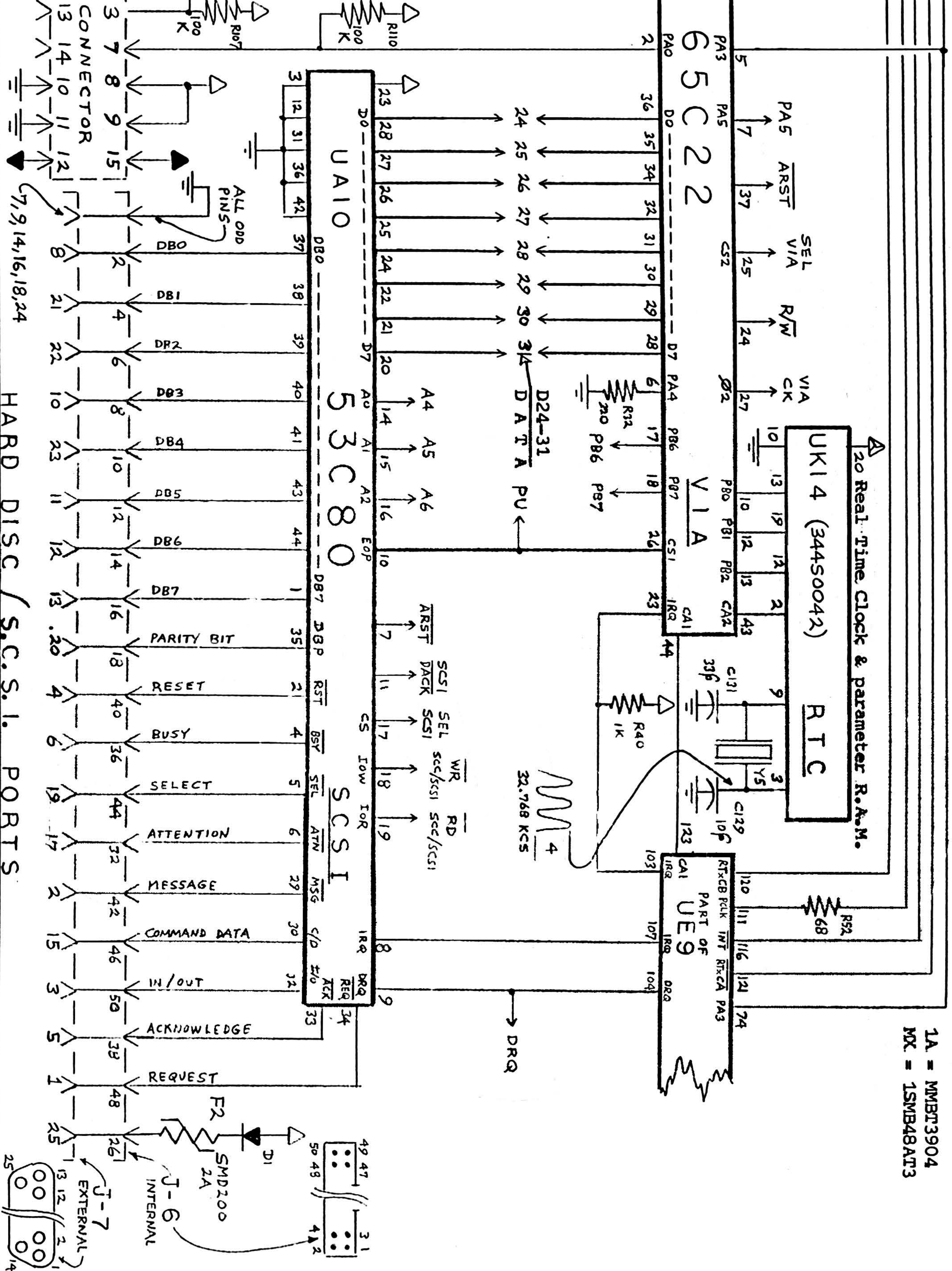

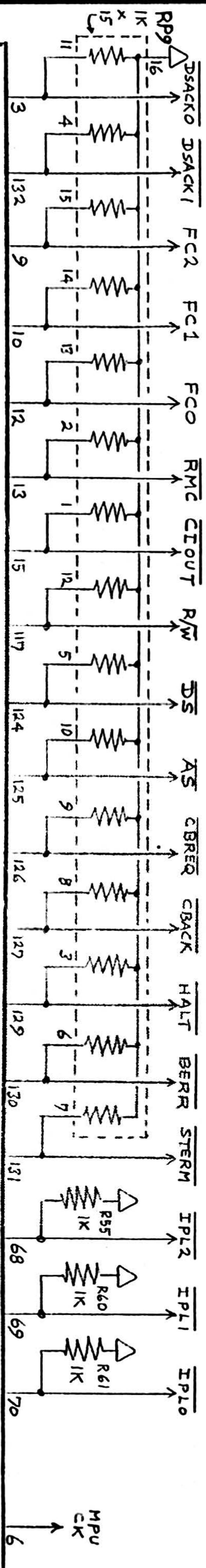

XC680

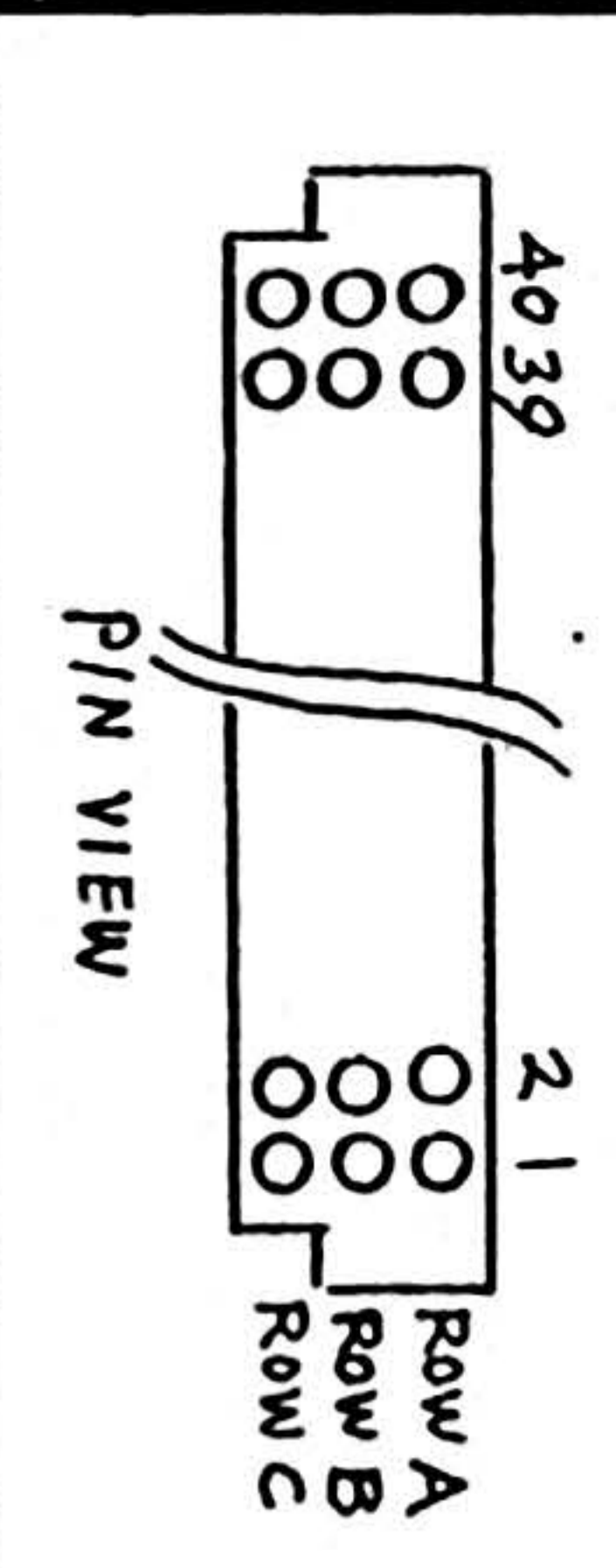
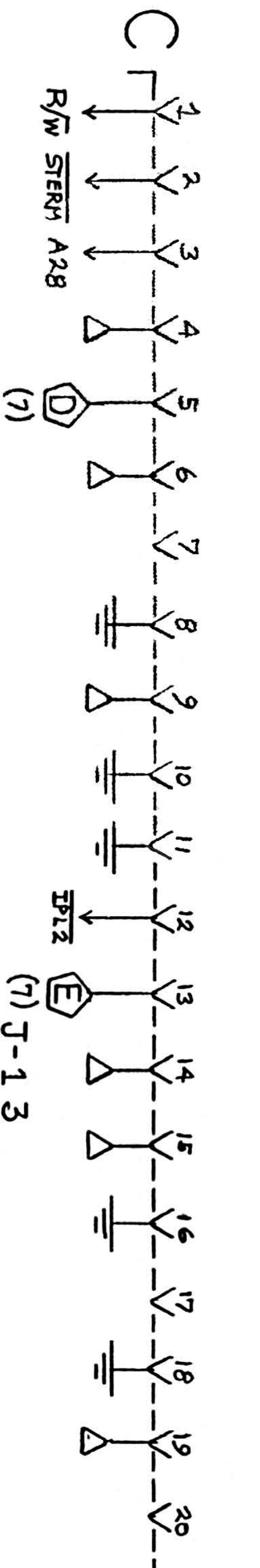
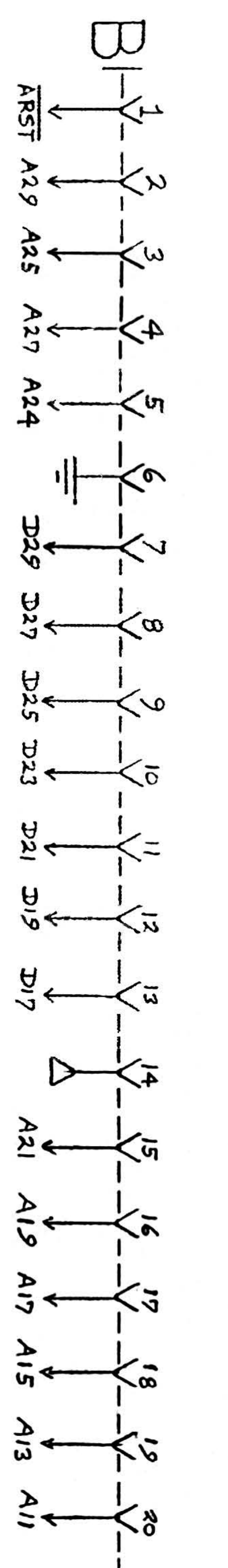
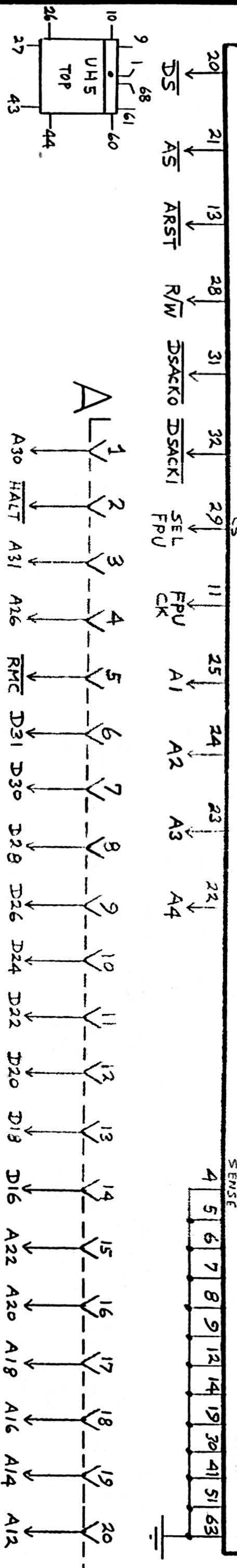
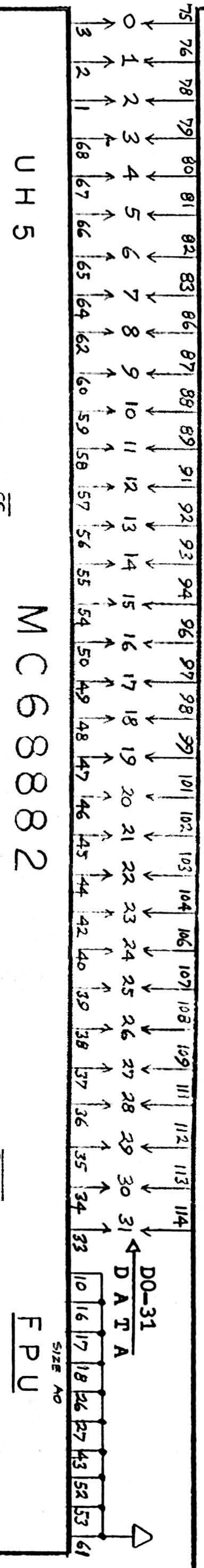

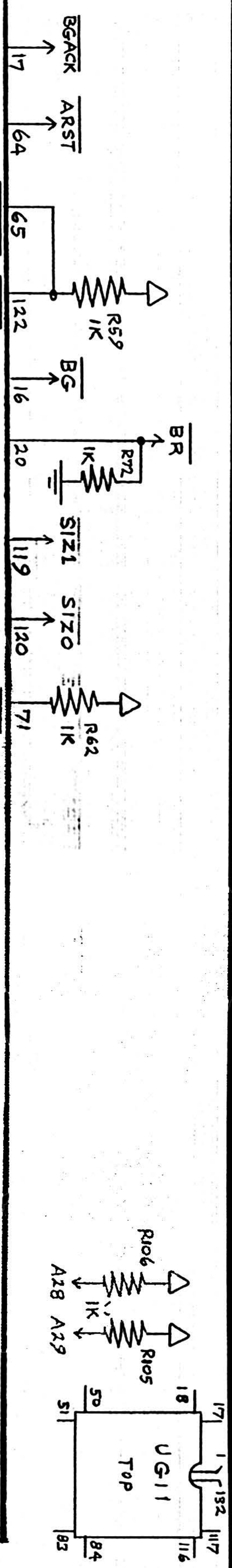

30 $\Delta = 4, 8, 18, 39, 49, 63, 72, 85, 105, 115, 116, 128$
 $\text{---} = 1, 2, 5, 11, 19, 25, 35, 44, 57, 60, 66, 67, 77, 90,$
 $\text{---} = 95, 100, 110, 123$

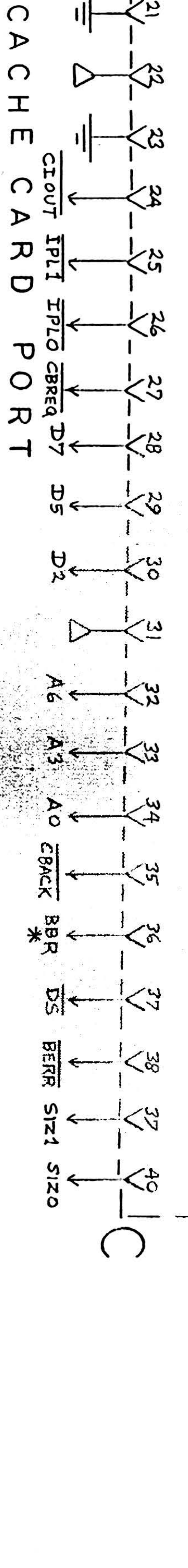
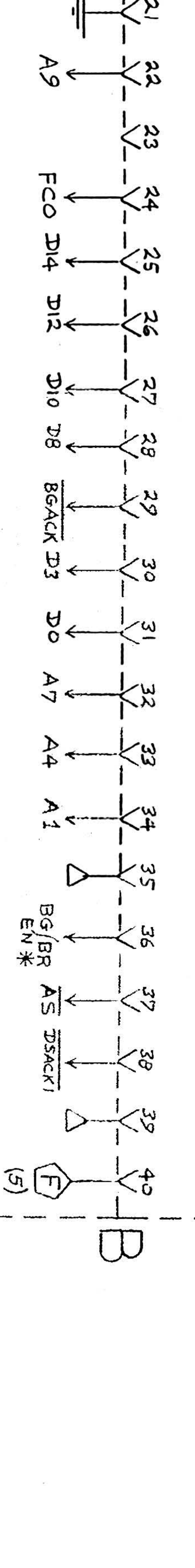
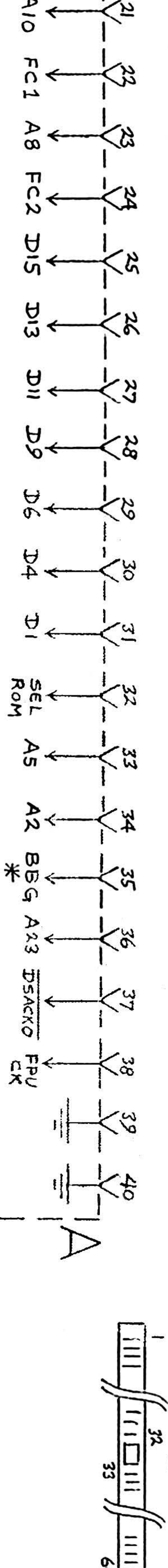
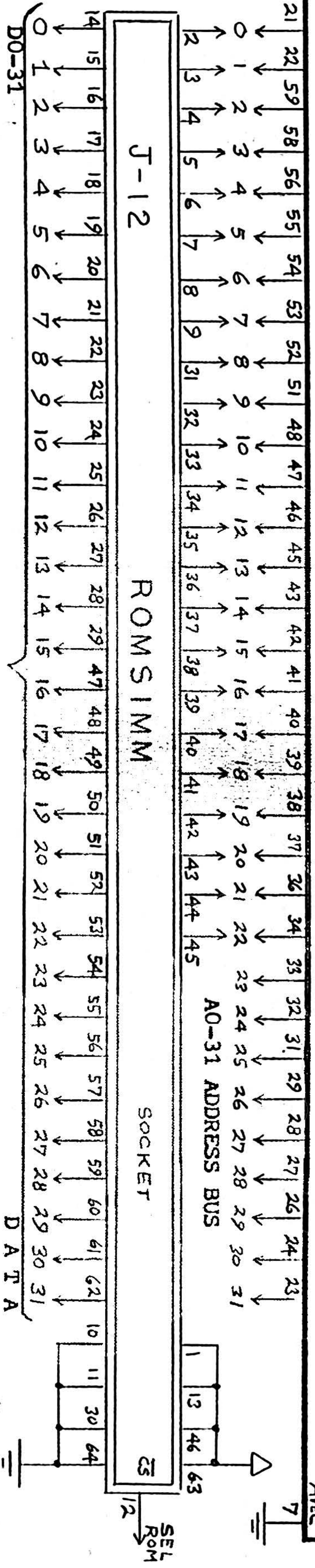

*to UH2 (sheet-6)

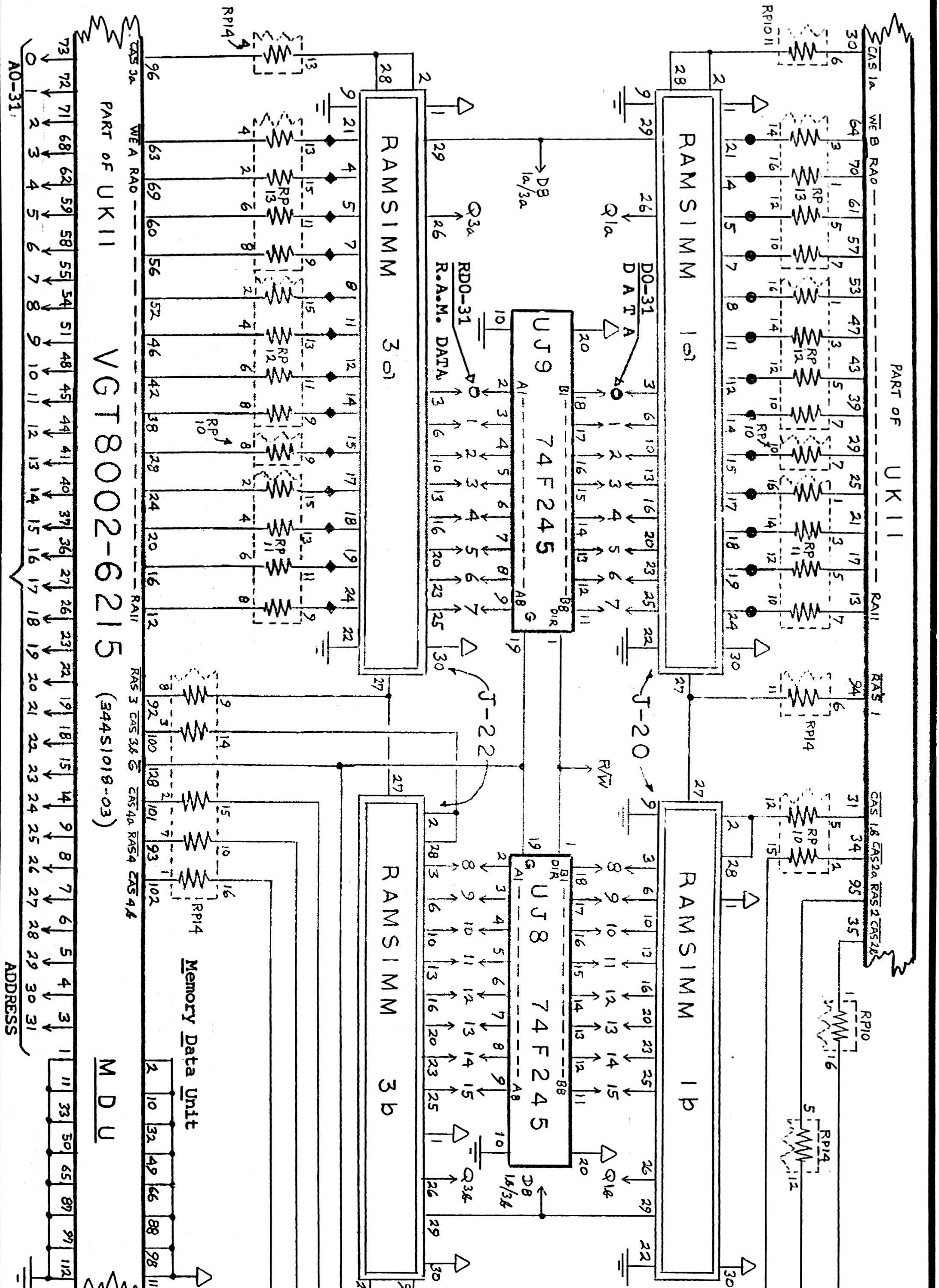

PART OF UK11

VGT8002-6215

(344S1018-03)

MDU

ADDRESS

PART OF UK11

RA11

RA5 1

CAS 18 CAS2a RAS 2 CAS2b

RP10

RP14

RP14

RP14

WE B

RA0

RA0

RA0

RA0

RA0

RA0

RA0

RA0

RA0

RA0

RA0

RA0

RA0

RA0

RA0

RA0

RA0

RA0

RA0

RA0

RA0

RA0

RA0

RA0

RA0

RA0

RA0

RA0

RA0

RA0

RA0

RA0

RA0

RA0

RA0

RA0

RA0

RA0

RA0

RA0

RA0

RA0

RA0

RA0

RA0

RA0

RA0

RA0

RA0

RA0

RA0

RA0

RA0

RA0

RA0

RA0

RA0

RA0

RA0

RA0

RA0

RA0

RA0

RA0

RA0

RA0

RA0

RA0

RA0

RA0

RA0

RA0

RA0

RA0

RA0

RA0

RA0

RA0

RA0

RA0

RA0

RA0

RA0

RA0

RA0

RA0

RA0

RA0

RA0

RA0

RA0

RA0

RA0

RA0

RA0

RA0

RA0

RA0

RA0

RA0

RA0

RA0

RA0

RA0

RA0

RA0

RA0

RA0

RA0

RA0

RA0

RA0

RA0

RA0

RA0

RA0

RA0

RA0

RA0

RA0

RA0

RA0

RA0

RA0

RA0

RA0

RA0

RA0

RA0

RA0

RA0

RA0

RA0

RA0

RA0

RA0

RA0

RA0

RA0

RA0

RA0

RA0

RA0

RA0

RA0

RA0

RA0

RA0

RA0

RA0

RA0

RA0

RA0

RA0

RA0

RA0

RA0

RA0

RA0

RA0

RA0

RA0

RA0

RA0

RA0

RA0

RA0

RA0

RA0

RA0

RA0

RA0

RA0

RA0

RA0

RA0

RA0

RA0

RA0

RA0

RA0

RA0

RA0

RA0

RA0

RA0

RA0

RA0

RA0

RA0

RA0

RA0

RA0

RA0

RA0

RA0

RA0

RA0

RA0

RA0

RA0

RA0

RA0

RA0

RA0

RA0

RA0

RA0

RA0

RA0

RA0

RA0

RA0

RA0

RA0

RA0

RA0

RA0

RA0

RA0

RA0

RA0

RA0

RA0

RA0

RA0

RA0

RA0

RA0

RA0

RA0

RA0

RA0

RA0

RA0

RA0

RA0

RA0

RA0

RA0

RA0

RA0

RA0

RA0

RA0

RA0

RA0

RA0

RA0

RA0

RA0

RA0

RA0

RA0

RA0

RA0

RA0

RA0

RA0

RA0

RA0

RA0

RA0

RA0

RA0

RA0

RA0

RA0

RA0

RA0

RA0

RA0

RA0

RA0

RA0

RA0

RA0

RA0

RA0

RA0

RA0

RA0

RA0

RA0

RA0

RA0

RA0

RA0

RA0

RA0

RA0

RA0

RA0

RA0

RA0

RA0

RA0

RA0

RA0

RA0

RA0

RA0

RA0

RA0

RA0

RA0

RA0

RA0

RA0

RA0

RA0

RA0

RA0

RA0

To like pins of bank "B" SIMM sockets
 to like pins of bank "A" SIMM sockets
 RP10-RP14 = SOMC1603-220G = 22 ohm x 15

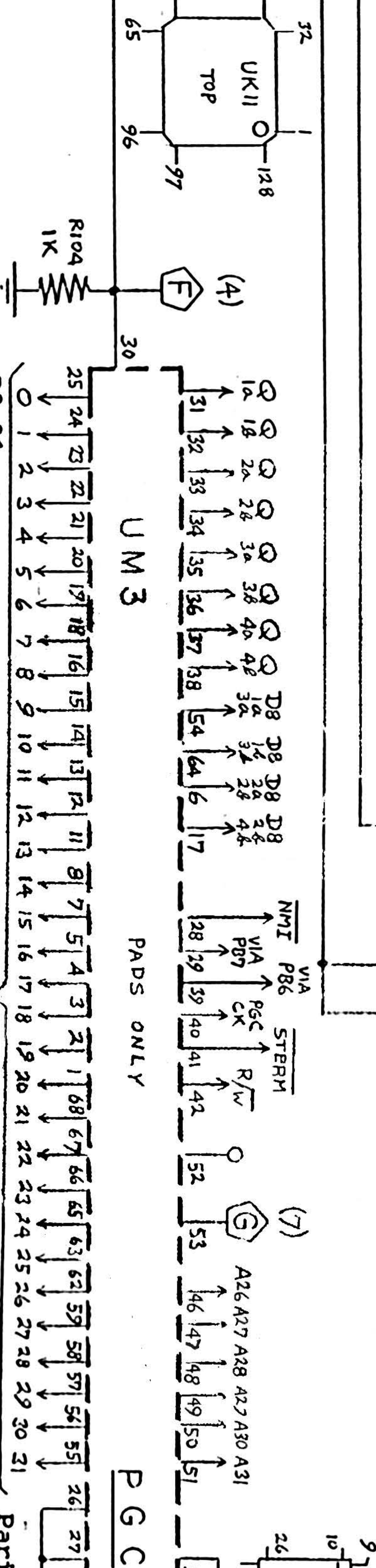
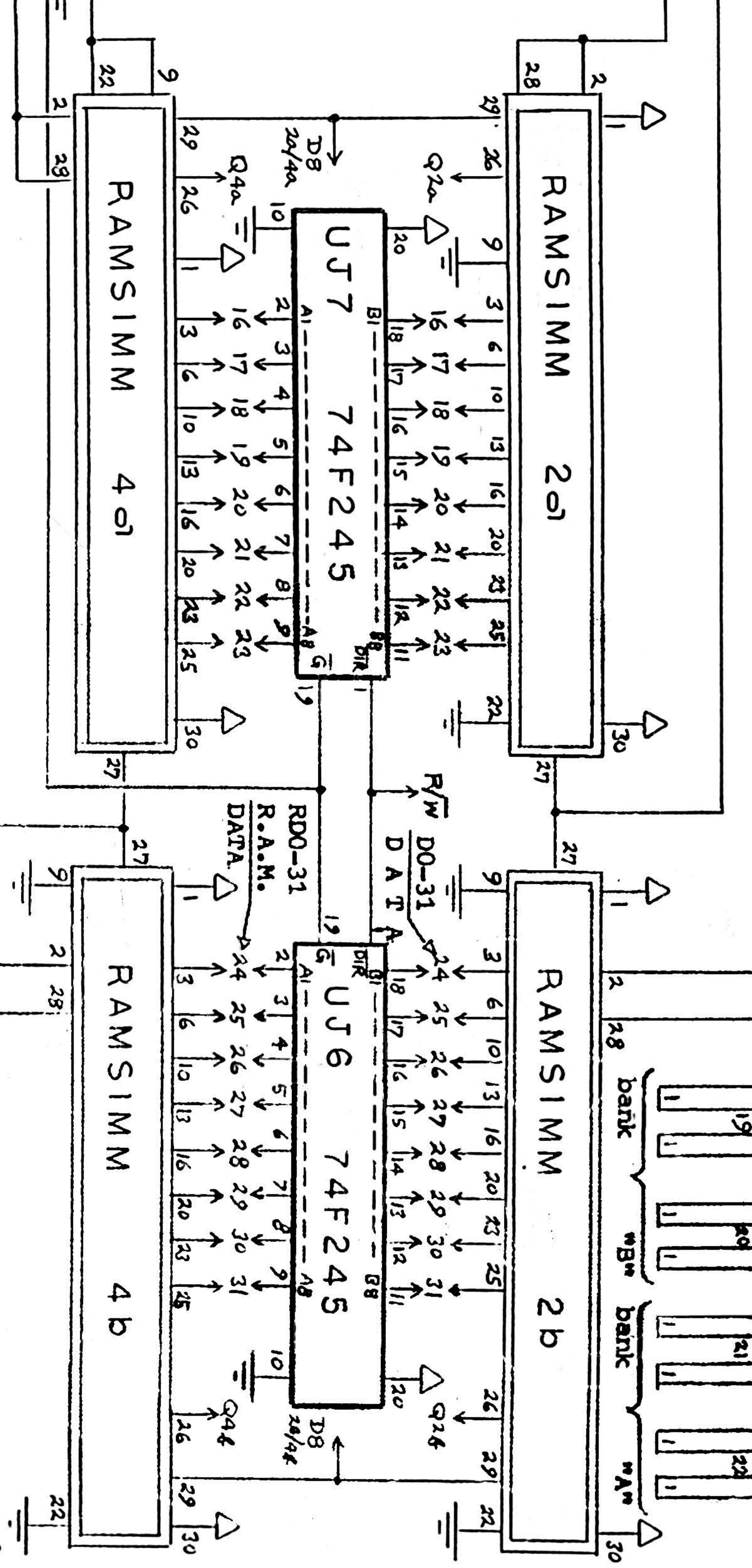
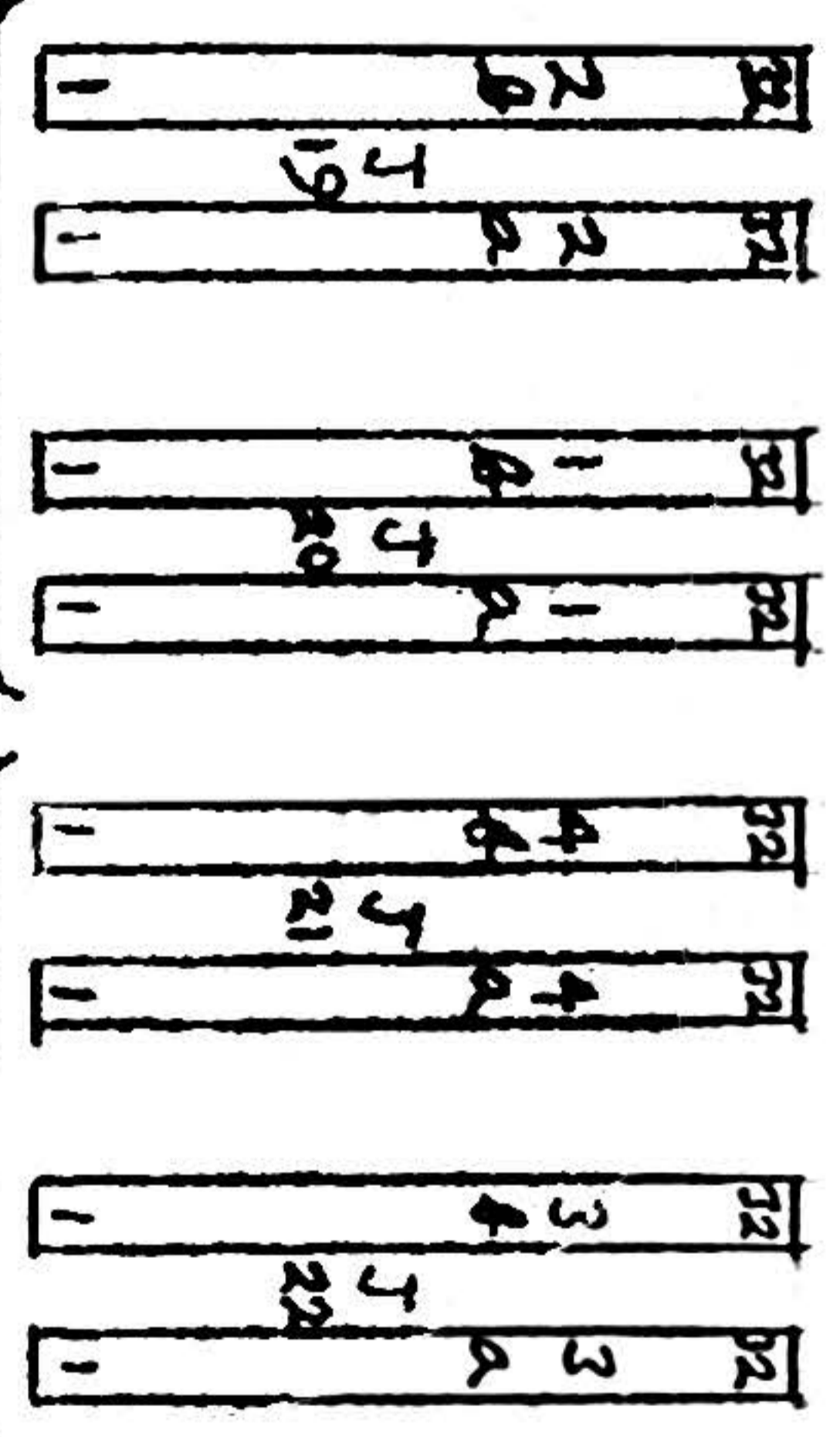

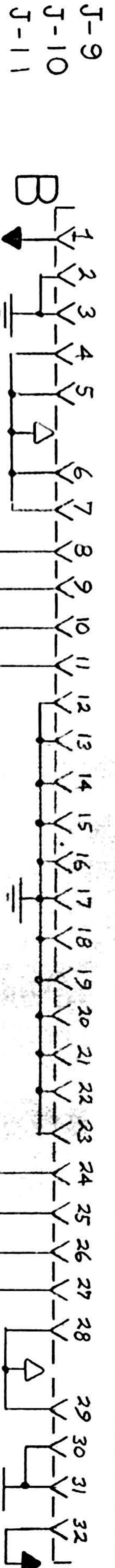

NOTE: All row pins common to all 3 NUBUS sockets EXCEPT those shown in chart at upper right.

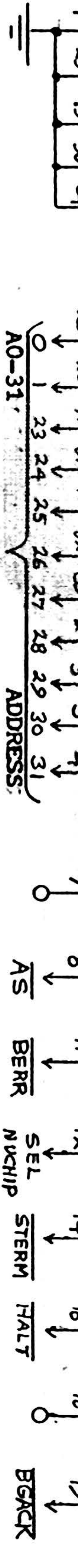
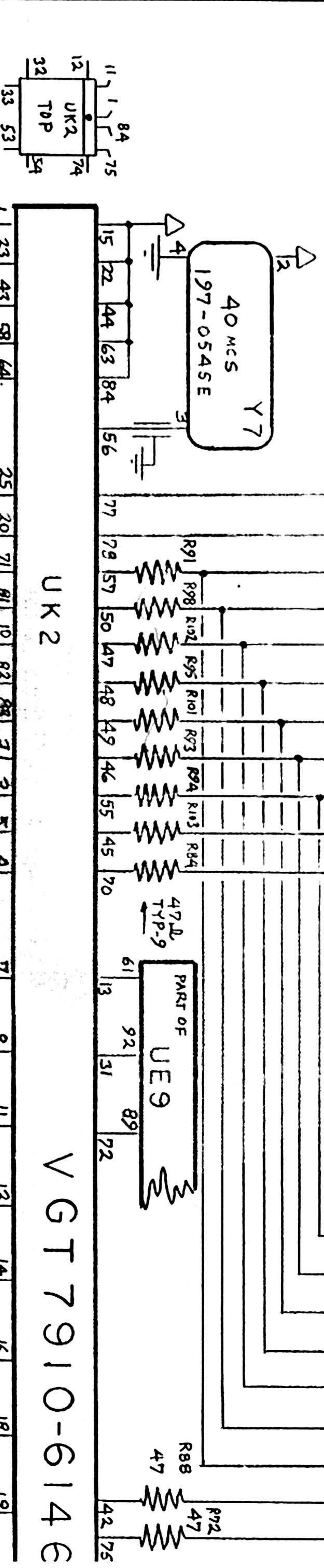
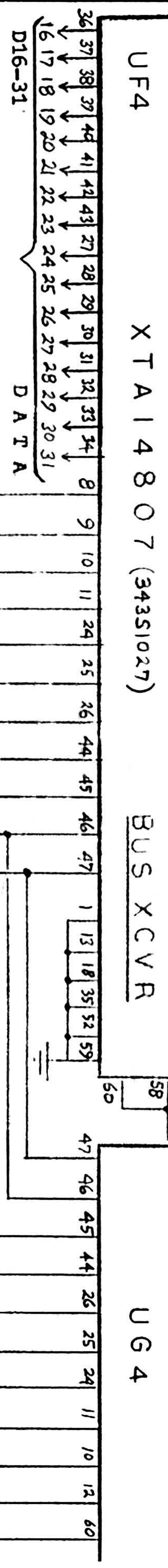
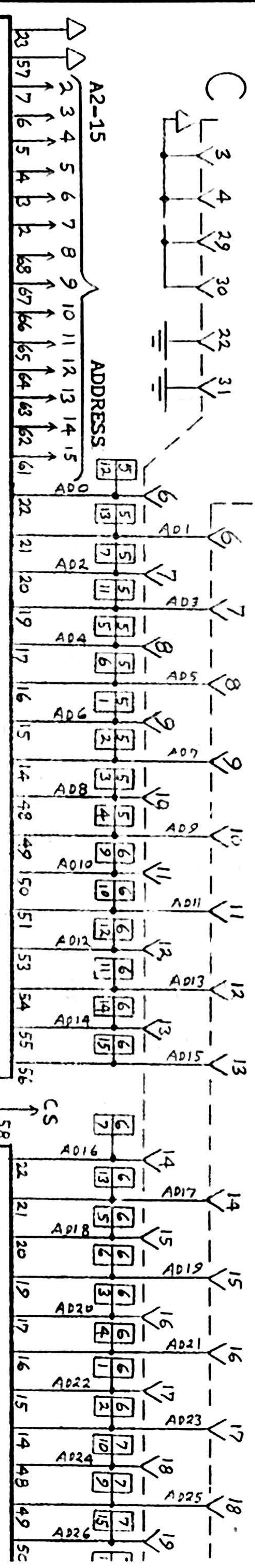

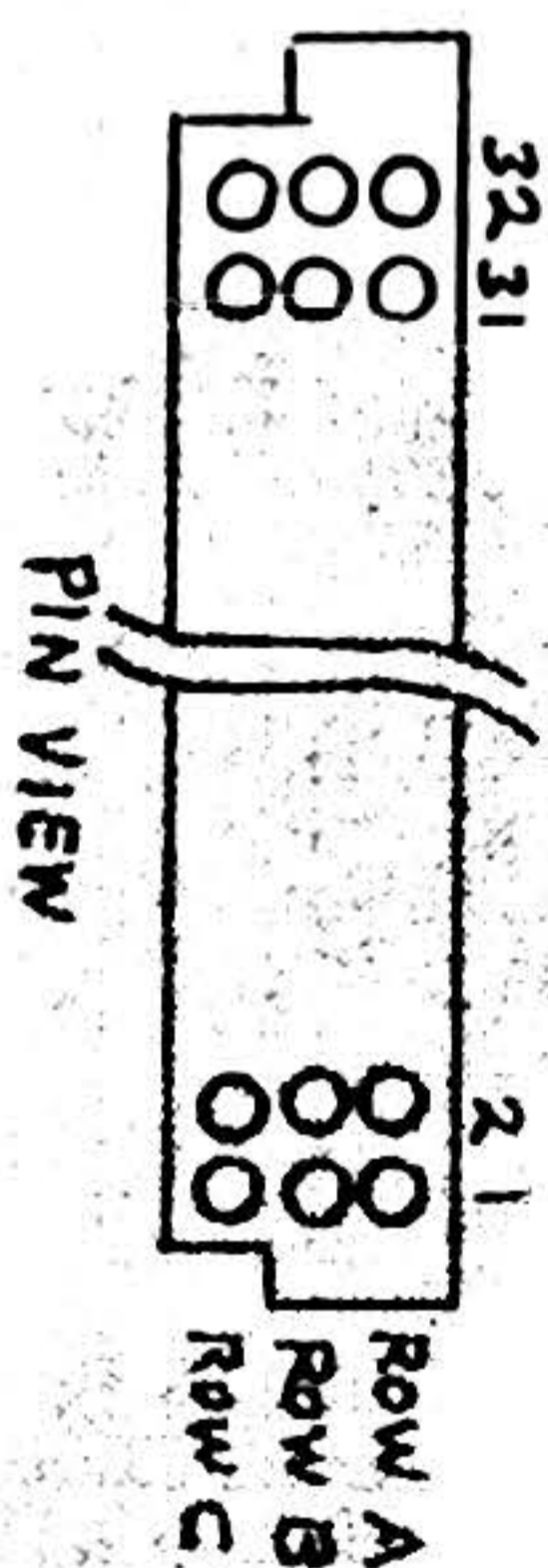
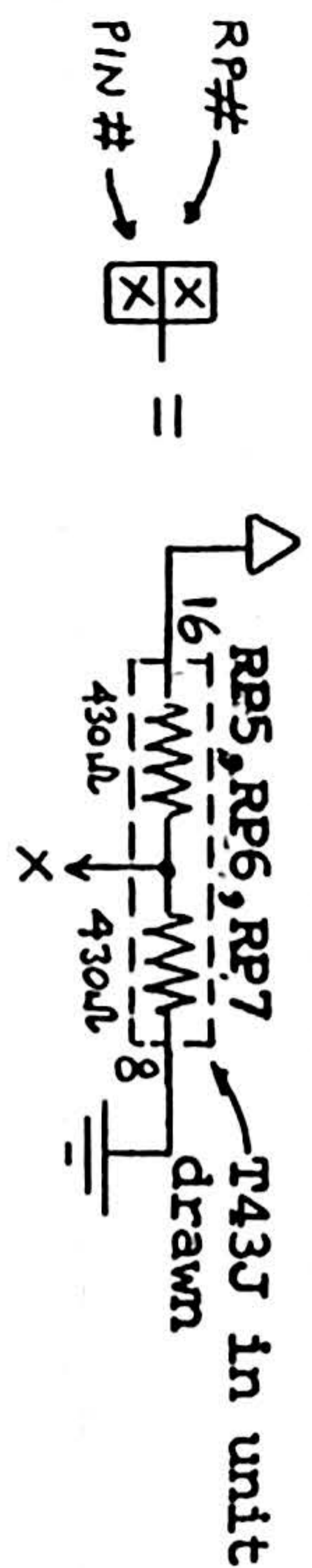

SOCKET	7	PIN	A26	A31	C26	C27
SLOT C	J9	OPEN	TO RBV	OPEN	GND	GND
SLOT D	J10	OPEN	TO RBV	GND	GND	GND
SLOT E	J11	GND	TO RBV	OPEN	GND	GND

I.C.	T Y P E	Δ	≡
UH1, UH3	74 ALS 240A.	20	10
UH2	74 F 244	20	10

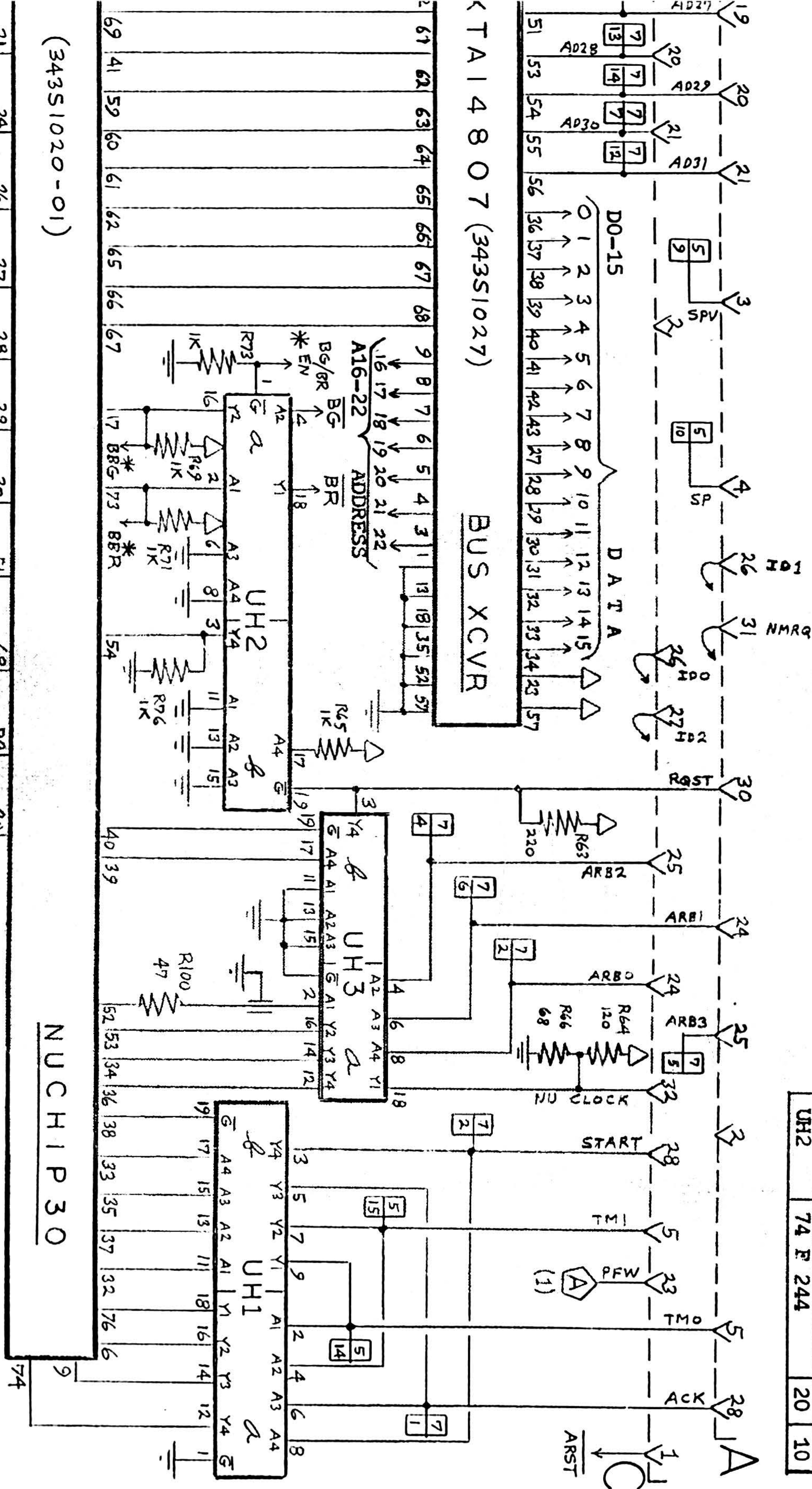

(343S1020-01)

NUCHIP P 30

* = To cache card socket (sheet-4)

NU-BUS PORTS CONTROL SECTION

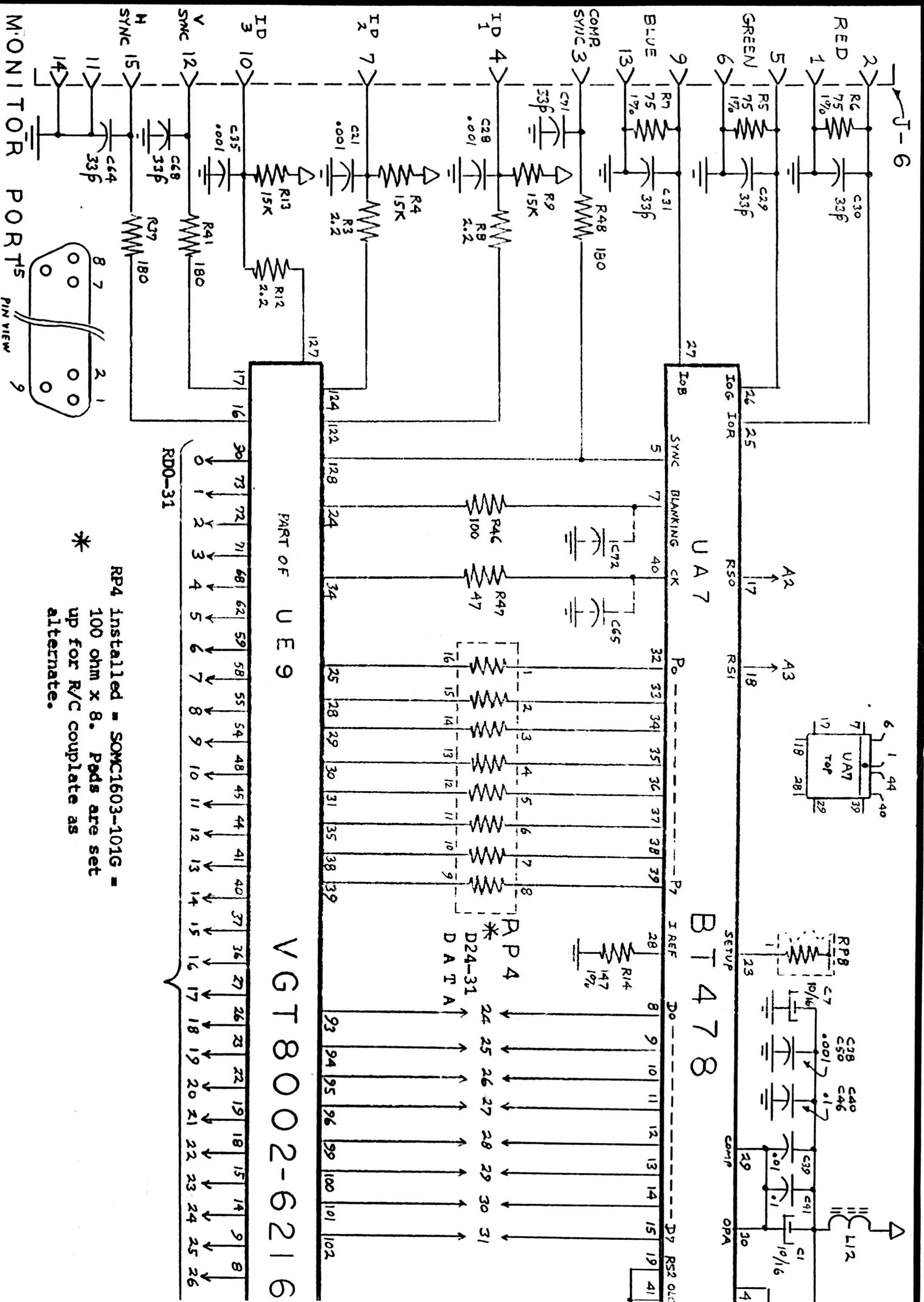

PART OF U E 9

VGT8002-6216

U A 7

B T 4 7 8

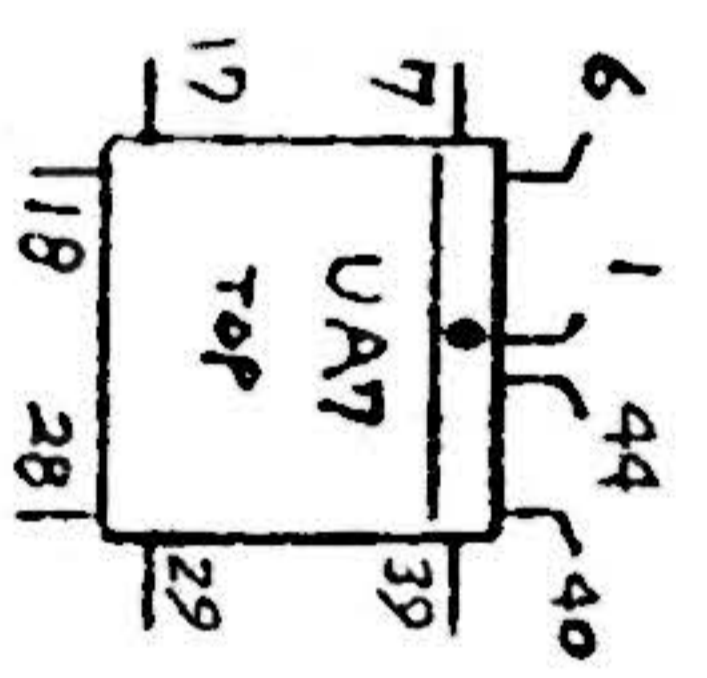

*
 RP4 installed = SOMC1603-101G =
 100 ohm x 8. Pads are set
 up for R/C couple as
 alternate.

RDO-31

MONITOR PORTS

PIN VIEW

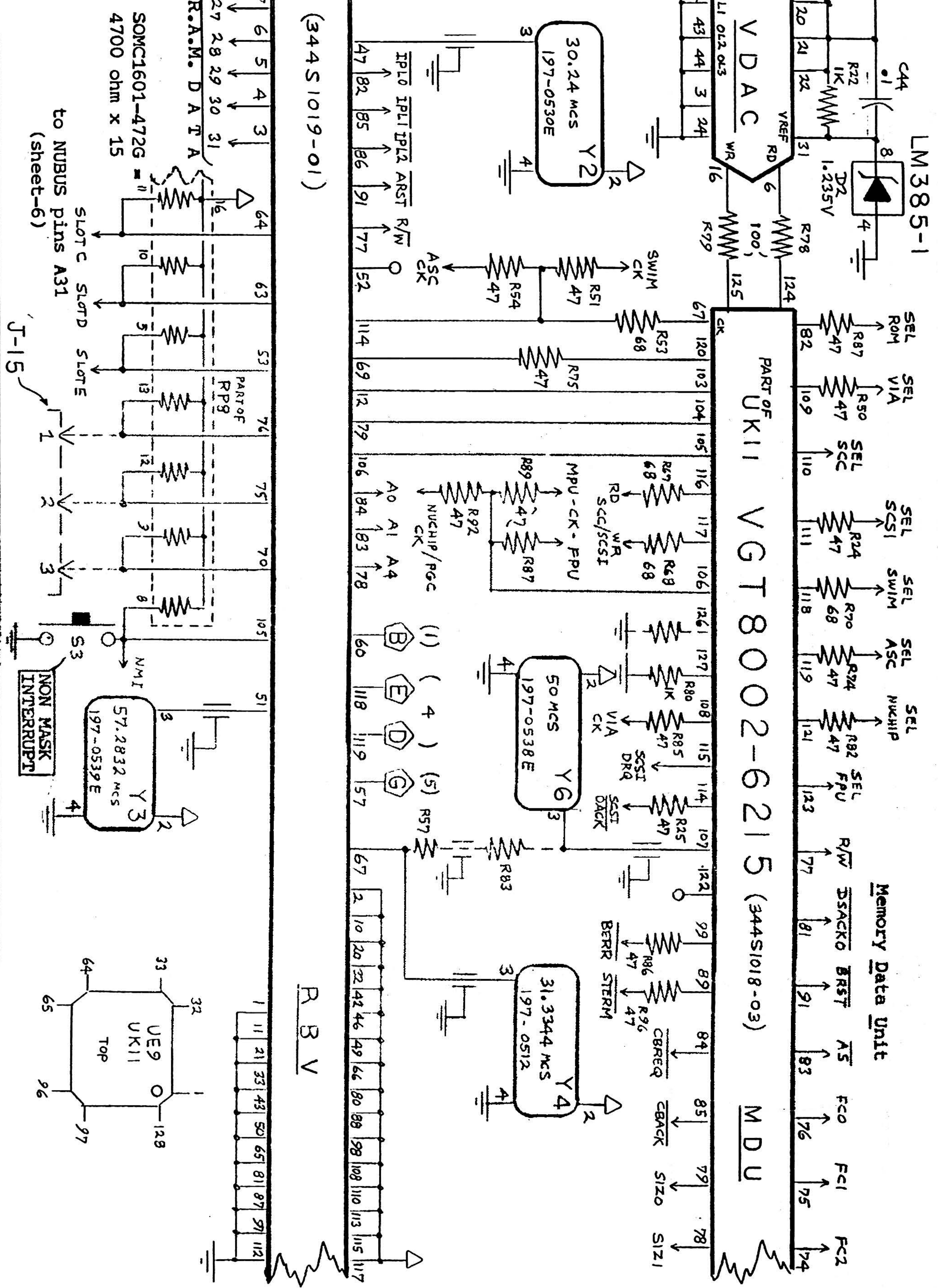

(344S1019-01)

PART OF UK11 VGT8002-6215 (344S1018-03) MDU

Memory Data Unit

R B V